



TableX is proud to release this new and improved price list. We've added new options, top shapes, and bases. We continue to look for ways to improve and expand our product line and bring better solutions to the market.

If at any time you have any questions, or need something above and beyond the models listed here, please don't hesitate to call. We are here to help you all the way.

TableX customer service: **877.481.1177**

Introduction	Page
pricing comparison	p. 2
terms & conditions	p. 4
<ul style="list-style-type: none"> pricing orders order acknowledgements terms lead times modified product cancellations & returns 	
freight	p. 5
<ul style="list-style-type: none"> freight charges shipping 	
sample purchase order	p. 6
warranty	p. 7
surface materials	p. 8
<ul style="list-style-type: none"> high pressure laminates powdercoat base colors 3mm pvc edges 3mm pvc knife edges wood edges rigid thermofoil coordinating finishes veneer upcharges 	
table options	p. 16
<ul style="list-style-type: none"> nesting tables folding tables flip top tables folding tables top options base options custom height options height adjustable options 	
seating capacities	p. 24

Product Pricing	p. 26
00 - Ultra series	p. 26
01 - Foundation series	p. 32
02 - Fundamental series	p. 48
06 - Stretch series	p. 64
08 - Elite series	p. 80
33 - Element series	p. 98
44 - Primary series	p. 114
45 - Puddle series	p. 134
71 - Exclaim series	p. 138
74 - VertiGo series	p. 150
88 - Next series	p. 172
99 - Surge series	p. 176
table accessories	p. 190
<ul style="list-style-type: none"> modesty panels privacy panels 	
power / data	p. 194
<ul style="list-style-type: none"> metal pop-up units budget units Daisylink systems Corded systems 	
wire management	p. 202
TableXpress quickship program	p. 204

24x60" rectangles

Something as simple as a 24x60" rectangular table can be specified many different ways. With 12 different standard series of bases, TableX has you covered. Use the matrix below to compare list pricing of each series, using a static, 24x60" rectangular table with a 3mm PVC edge.



Ultra
p.26

\$816 List

Foundation
p.32

\$619

Fundamental
p.48

\$571

Stretch
p.64

\$593

Elite
p.80

\$720

Element
p.98

\$609

Primary
p.114

four columns
\$660

Primary
p.114

two 99 discs
\$1,103

Primary
p.114

two 44 discs
\$1,336

Puddle
p.134

two 45 discs
\$1,156

Exclaim
p.138

\$784

VertiGo
p.150

\$638

Next
p.172

\$866









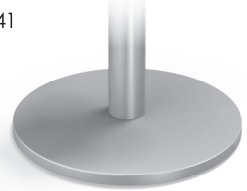
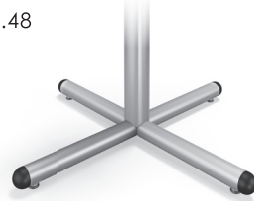
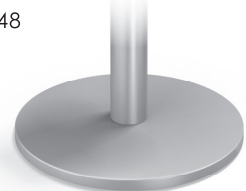

Surge
p.176

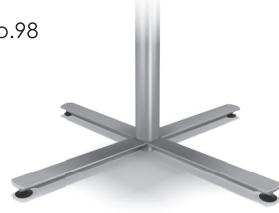
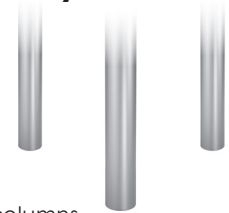
\$642

36" rounds

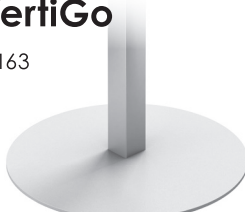
Cafe tables with X-bases and disc bases are everywhere. TableX offers a wide variety of bases that give you plenty of choices. Use the matrix below to compare list pricing of each series, using a static, 36" round table with a standard 3mm PVC edge.

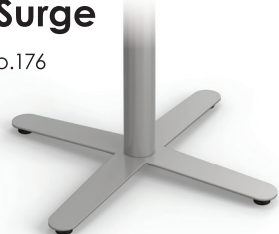

<p>Foundation</p> <p>p.32</p>  <p>\$626 List</p>	<p>Foundation</p> <p>p.41</p>  <p>44 disc \$863</p>	<p>Fundamental</p> <p>p.48</p>  <p>\$578</p>	<p>Fundamental</p> <p>p.48</p>  <p>44 disc \$863</p>
<p>Stretch</p> <p>p.64</p>  <p>\$762</p>	<p>Elite</p> <p>p.80</p>  <p>\$731</p>	<p>Element</p> <p>p.98</p>  <p>\$735</p>	<p>Primary</p> <p>p.114</p>  <p>four columns \$654</p>
<p>Primary</p> <p>p.127</p>  <p>99 disc \$747</p>	<p>Primary</p> <p>p.127</p>  <p>44 disc \$863</p>	<p>Puddle</p> <p>p.134</p>  <p>45 disc \$774</p>	<p>VertiGo</p> <p>p.163</p>  <p>\$766</p>
<p>VertiGo</p> <p>p.163</p>  <p>74 disc \$776</p>	<p>Next</p> <p>p.172</p>  <p>\$705</p>	<p>Surge</p> <p>p.176</p>  <p>\$702</p>	<p>Surge</p> <p>p.183</p>  <p>99 disc \$747</p>

Pricing

All prices quoted are list prices, FOB our warehouse. All documentation and literature is based on the most recent information available at the time of this publication. We reserve the right to make product improvements and design enhancements at any time, without notice. Prices are subject to change without notification.

Orders

All orders must be received in writing with complete information. See page 14 for a sample purchase order and a checklist of information that is required to place an order.

E-mail orders to:
sales@tablex.com

Fax orders to:
812.481.1178

Duplicate orders that are not marked as such are the responsibility of the customer.

Order Acknowledgements

Orders are acknowledged upon receipt at TableX. No order shall be binding upon TableX until we confirm it with an acknowledgement. The customer bears sole responsibility for order correctness. All orders will be manufactured and invoiced in accordance with the acknowledgement. Customers must notify TableX in writing of any discrepancy **within 5 days**. Any subsequent change order is dependent upon our ability to accommodate the specification, terms and status of the order in production, and may be subject to additional charges for labor, material and other costs involved.

Terms

Terms are Net 30 days from the date of invoice. Payment is due when invoice is issued and is considered delinquent if not paid within 30 days. Interest will be charged at the rate of 1.5% per month on delinquent accounts. TableX does not create or provide statements.

Lead Times

Lead times can vary based on product availability, fluctuations in busy season, and national holidays. Please contact customer service at 877.481.1177 for current lead times.

Note: Selecting certain options (wood edges, chrome bases, or thermofoil tops) can impact lead time. Below are estimated lead times based on normal business conditions.

Laminate	Edge	Base	Standard Lead Time
<i>TableXpress Program</i>			<i>5-day quickship</i>
standard	3mm PVC	standard	4-5 weeks
rigid thermofoil tops			4-6 weeks
solid surface tops			4-6 weeks
	3mm wood		6-8 weeks
	1.25" wood		6-8 weeks
		chrome	6-8 weeks

Modified Product

TableX prides itself on providing you with product that exceeds your expectations. Sometimes your needs are outside the standard product offering. Our flexibility as a small company allows us to accommodate requests for non-cataloged product. Contact Customer Service at 877.481.1177 to discuss your unique product requirements and we'll help you meet your needs.

Cancellations & Returns

Our acceptance of an order is final and binding and not subject to cancellation by the customer. No merchandise may be returned without the written consent of TableX.

Freight Charges

TableX is located in Jasper, Indiana. All shipping zones are based on proximity to our facility.

Minimum Orders

Standard freight charges apply to any order under \$3,000 total list price shipping within the continental United States. The standard charge for each zone is shown below, based on the total list price of the order.

Tiered Freight Program

These freight charges are reduced or waived on orders based on their total list price. The qualifying list prices for each zone are shown below.

Shipping

All shipments are F.O.B., dock-to-dock from our warehouse. Charges for additional services such as lift gates, non-commercial deliveries, inside deliveries, etc. are the responsibility of the buyer and may be charged to the buyer after the date of delivery.

Legal responsibility for the product transfers to the buyer upon acceptance by the carrier. Damaged, lost or shorted shipments are the responsibility of the carrier. Inspect all shipments promptly upon arrival and note any damage or loss on the delivery receipt. If damage is concealed, keep the packing and notify the carrier immediately for an inspection. Carriers require such reports within 5 days of delivery. Failure to report damage or loss is the consignee's responsibility. The freight charges may be collect to the receiver, billed to the purchaser, or prepaid by TableX.

Freight Claims

Legal title to merchandise passes to the buyer upon acceptance by the carrier. All cartons must be carefully inspected upon delivery for visible and concealed damage. If concealed damage has occurred, the carrier must be notified within (5) days. All of our product is thoroughly inspected before it leaves the factory, therefore it is the buyer's responsibility to seek recourse against the carrier.

- online updates
- new product
- clarification / edit
- deletion

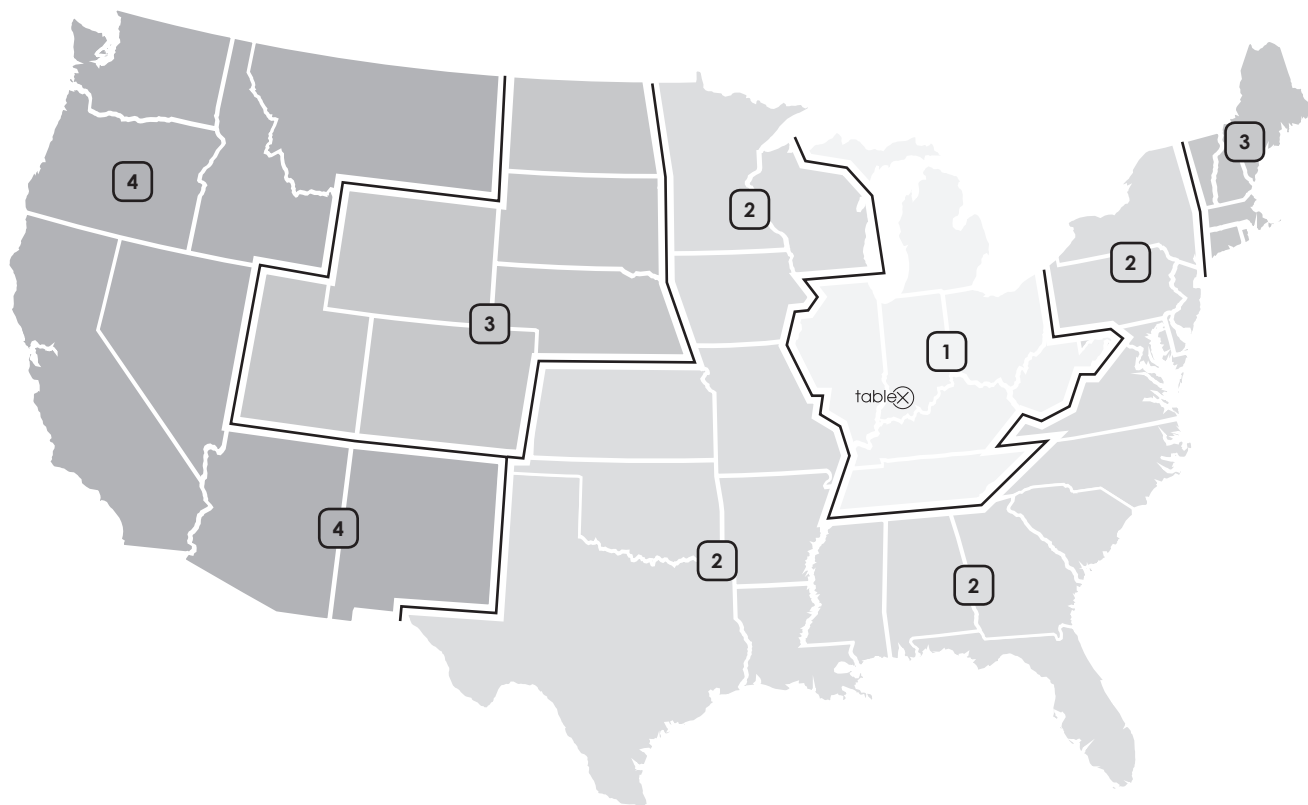

Zone	Destination State	Total List Price / Freight Charge				
		< \$3K	> \$3K	> \$5K	> \$7.5K	> \$10K
1	IL, IN, KY, MI, OH, TN, WV	\$100	free freight			
2	AL, AR, DE, FL, GA, IA, KS, LA, MD, MN, MO, MS, NC, NJ, NY, OK, PA, SC, TX, VA, WI	\$200	\$100	free freight		
3	CO, CT, MA, ME, ND, NE, NH, RI, SD, UT, VT, WY	\$250	\$200	\$100	free freight	
4	AZ, CA, ID, MT, NM, NV, OR, WA	\$300	\$250	\$200	\$100	free

Email orders to:
sales@tablex.com

Fax orders to:
812.481.1178

When sending in a purchase order, be sure to include the following items. Each of these is important in ensuring that your order is processed accurately and in a timely manor.



Furniture Dealer
123 Main St.
Middletown, US 12345

ph. 123.456.7890
fax 123.456.7890

PURCHASE ORDER

page 1 of 1

PO #	Date
12-34567-89	06 / 01 / 2018

your PO #

we will include this on your order acknowledgement for easy tracking.

TO: TableX
555 Cathy Lane
Jasper, IN 47546

SHIP TO: Furniture Dealer
123 Main St.
Middletown, US 12345

'ship to' address
check page 3 to see how location will effect freight charges.

Line	Quantity	Model # / Description	Unit Price	Ext. Price
		Special Intructions: Call 24 hours before delivery: James Abbott, 123.456.7890 Dealer contact: Peter Gray, 123.456.7890		
1	12	01TC2460T22NE-3P-GR.A - 7960K-18/3021/08 Foundation 24x60" rectangular table with 22" wide T-bases. NE: nesting with locking casters GR.A: 1 grommet in location A List Price: \$1,116 Discount: 50/10 Laminate: Wilsonart 7960K-18 Studio Teak 3P: 3MM EDGE: 3021 Espresso BASE: 08 Structured Chocolate TAG: training room	502.20	6,026.40
2	5	08RD48X36-W2 - 7054-60/NG/21 Elite 48" round table with 36" wide X-base. List Price: \$1,460 Discount: 50/10 Laminate: Wilsonart 7054-60 Wild Cherry W2: WOOD EDGE: NG Nutmeg BASE: 21 Silver Frost TAG: break room	657.00	3,285.00
Freight			0.00	0.00
Total order amount				9,311.40

special instructions
this includes but is not limited to a requested delivery date, call before delivery, dealer contact, and tagging instructions.

complete model #
include any options and your surface materials.

list price & discount
this is important so that we can double check any options and upcharges.

surface materials
double check to make sure these are included. this is the piece most often left off of a PO.

freight charges
many larger orders qualify for free freight. reference the chart on page 3 to verify your costs.

- **line item #**
makes cross referencing much easier if we have any questions.
- **quantity**
exactly how many of these do you need?
- **product tagging**
we will include this on the label underneath each table.



Warranty

effective January 1, 2018

TableX merchandise limited warranty on the original purchase covers normal use for 50 years from date of shipment against defect with workmanship and materials.

Electrical components are covered for 1 year. Moving components; such as, but not exclusive to; flip top mechanisms and height adjustment mechanisms are covered for 5 years. Note of exception on Nesting Extrusions, warranty is 10 years.

Wood veneers, Formica, Wilsonart, Pionite, and Nevamar laminates, and rigid thermofoil laminates are covered by the specified surface manufacturer under their particular warranty only. TableX does not promote laminate "self edge" tops due to their tendency to be damaged during everyday use. Self edge tops are done by special request only, and are covered for 1 year.

Finishes, when exposed to ultraviolet rays, may change color. Desktop accessories with rubber or plastic feet can penetrate or burn a finish. These issues are not warranted and will not be the responsibility of TableX.

Exclusions include:

- Normal wear and tear over course of ownership or abuse beyond originally intended use of product.
- Modifications or additions to the product, or final product assembly that is not TableX approved.
- Product used for rental purposes
- Damage caused by misapplication of cleaning chemicals or improper use of core and cleaning procedures.
- Surface materials damaged by excessive humidity or dryness in an uncontrolled environment.

Any repairs or modifications by the customer must receive specific written authorization from TableX prior to being executed.

In no event shall liability under this warranty exceed the original purchase price of the product.

High Pressure Laminates

Standard Laminates

TableX stocks over 50 laminates. With a large selection of patterns, solids, and woodgrains, these laminates are all available at standard pricing.

Special Laminates

TableX also offers Wilsonart, Nevamar, Pionite, and Formica laminates. In most cases, if it is part of their standard offering, it can be used at standard pricing. Please check with customer service if you have a question regarding any special laminates.

TableXpress Quickship Program

When ordering TableXpress quickship products, you must select from our standard list of stocked laminates.

Samples

Laminate samples are available by request. Scans of these laminates are also available on tablex.com for reference, but because of variations in monitor and printer calibration we do not suggest specifying without seeing a physical sample.



Pattern Laminates		Solid Laminates		Woodgrain Laminates	
299-58	Ebony Oxide	D96-60	Shadow	7054-60	Wild Cherry *
4552-60	Ebony Star	D315-60	Platinum	7122K-07	Empire Mahogany *
4621-60	White Nebula	D354-60	Designer White	7933K-07	Cafelle *
4622-60	Grey Nebula	D355-60	Gunmetal	7943K-07	Colombian Walnut *
4623-60	Graphite Nebula	D439-60	Wallaby	7946-38	Brazilwood *
4656-60	Bronze Legacy	1500-60	Grey	7960K-18	Studio Teak *
4668-60	Mushroom Tigris	1573-60	Frosty White	7965K-12	Walnut Heights *
4779-60	Pewter Brush	1595-60	Black	10776-60	Kensington Maple *
4783-60	White Tigris	D91-60	Slate Gray		
4810-60	Titanium Ev	D381-60	Fashion Grey		
4811-60	Silicon Ev	D431-60	Alabaster		
4813-60	Nickel Ev	899-58	Desert Beige		
4814-60	Tungsten Ev	928-58	Mouse		
4820-60	Carbon Ev	7197-58	Dover White		
4841-60	Desert Zephyr	8751-58	Mojave		
4842-60	Canyon Zephyr				
4843-60	Misted Zephyr				
4844-60	Loden Zephyr				
4846-60	Morro Zephyr				
4876-38	Sheer Mesh				
4879-38	Steel Mesh				
4942-38	Crisp Linen				
6220-58	Smoke Quarstone				
6729-58	Paloma Bisque				
7708-58	Flax Gauze				
8830-58	Elemental Concrete				
AT951	Neutral Santos				
MR6008T	Birch Matrix				
PO7001T	Paris White Potteryware				

* Matching standard 3mm edge available.

Powdercoat Base Colors

Standard Powdercoat Finishes

TableX offers 26 different powdercoat finishes. Most product lines are available in the full offering of powdercoat colors. Check the series intro for any product specific limitations.

Chrome

Chrome is available on many of our table lines for a standard upcharge per table. Please check the series intro for availability. Also note that chrome bases add 3-4 weeks to the standard leadtime.

*Brushed Steel & Ruby

Brushed Steel and Ruby are only available on the models that are available in chrome... but without the upcharge. Check series intro for availability.

Samples

Paint samples are available by request. Scans of these paint colors are also available on tablex.com for reference, but because of variations in monitor and printer calibration we do not suggest specifying without seeing a physical sample.



Standard Powdercoat Finishes					
01	Structured Black	17	Creme	30	Pearl
02	Black	19	Foundry	31	Sun Gold
05	Structured Slate	21	Silver Frost	33	Moonstone
06	Structured Concrete	23	Phantom	34	Iron Alloy
08	Structured Chocolate	24	Linen	35	Sand
10	Silhouette	25	Storm	36	Espresso
11	Smoke	28	Oyster	37	Satin Silver
15	Stone	29	Flint	38	Tungsten Metallic

Premium Finishes	
CH	Chrome
03	Brushed Steel *
32	Ruby *

3mm PVC Edges

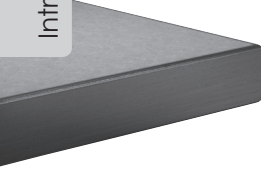

3P
Flat



3P
Reed

Standard Edges

TableX stocks 11 solid edge colors and 21 woodgrain edges. Seven of those woodgrain edges are also available as a reeded edge.

TableXpress Quickship Program: When ordering TableXpress quickship products, you must select from our standard list of 3mm PVC edges. Knife edge is not available.

Samples

Edge samples are available by request. Scans of these edges are also available on Tablex.com for reference, but because of variations in monitor and printer calibration we do not suggest specifying without seeing a physical sample.

Solid 3mm PVC Edges

001	Medium Grey
015	Charcoal
016	Haze
D354	Designer White
1096	Pepperdust
480	Antique White
2416	Black
3018	Shark
3020	Iron Alloy
3021	Espresso
7044	Foundry

Woodgrain PVC Edges

TX091	Bayshore Maple	7054	Wild Cherry *
TX093	Amaretto Maple	7946	Brazilwood
TX095	Bramble Walnut	10776	Kensington Maple *
TX096	Molasses Cherry	FTX087	Coastal Maple
TX098	Dusk Walnut	FTX089	Colombian Walnut *
TX102	Fireberry	F3022	Warm Cherry
TX103	Walnut Heights *	F3023	Empire Mahogany *
TX104	Studio Teak *	F3024	Traditional Cherry
TX108	Cashew Rift	F3025-2	Blonde Maple 2
TX109	Chestnut Rift	F3026	Cafelle *
TX110	Ashen Rift		

Woodgrain Reed Edges

RTX087	Coastal Maple
RTX089	Colombian Walnut *
R3022	Warm Cherry
R3023	Empire Mahogany *
R3024	Traditional Cherry
R3025-2	Blonde Maple 2
R3026	Cafelle *

* Matching standard laminate available.

3mm PVC Knife Edges

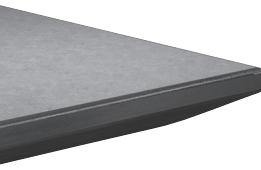

3K
Knife

Knife Edges

Any standard 3mm edge is available as a knife edge. Simply specify the 3mm edge and also specify the paint color for the exposed MDF core. There are six colors available. Each is based on a Wilsonart solid laminate color of the same name.

PVC Knife Edges Core Colors

K91	Slate Grey
K315	Platinum
K354	Designer White
K439	Wallaby
K495	Coffee Bean
K1595	Black

Wood Edges

Please check top shape for availability. Also note that wood edges add 3-4 weeks to the standard leadtime.

TableXpress Quickship Program
Wood edged tops are not available on our TableXpress program.

Care & Maintenance

Clean all surfaces with water-dampened soft cloth in the direction of the grain. Quickly buff dry.

Immediately remove any liquids that come in contact with the wood surfaces using a blotting action to absorb the liquid. Lift objects to move them. Never pull them across the finished surface. Avoid exposing furniture to extreme heat and cold or to wide humidity variances.

Avoid exposing furniture to strong sunlight. Exposure to sunlight over time will cause finish variation. Do not use soaps, commercial cleaners or harsh solvents as they will cause finish deterioration. If using a protective glass top, place spacer pads under the glass top to allow the wood to breathe.

Samples

Wood finish samples are available by request. Scans of these finishes are also available on tablex.com for reference, but because of variations in monitor and printer calibration we do not suggest specifying without seeing a physical sample.

Wood Edge Finishes					
AD	Almond	CI	Cocoa Infusion	NG	Nutmeg
BH	Butterscotch	CT	Chestnut	SE	Spice
BV	Black Velvet				

W1
Bullnose

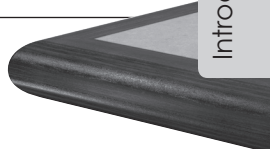

W2
Square

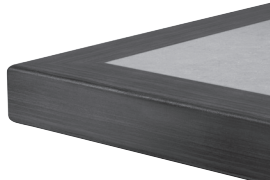

W3
Fluted

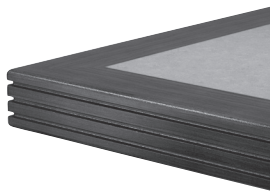

W4
Reverse

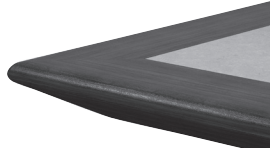

3W
Flat

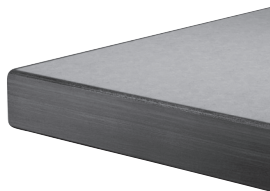

Rigid Thermofoil

F1
Waterfall

Standard Thermofoils

TableX offers a variety of thermofoil patterns to choose from. Please check tablex.com for the most up-to-date product offering.

Please check top shape for availability. Also note that thermofoil tops add 3-4 weeks to the standard leadtime.

Care & Maintenance

Cleaners such as, alcohol, benzene, and non-abrasive household detergents can be used. The practice of using any solvent based or abrasive type cleaners is not recommended. TableX recommends the use of a soft, clean cloth when cleaning the Rigid Thermofoil surfaces.

Corners

All thermofoil tops come with a standard 1" radius on all corners. The optional 3" radius is available for \$55 list upcharge.

TableXpress Quickship Program

Rigid Thermofoil tops are not available on our TableXpress program.

Samples

TableX thermofoil sample books are available by request. Scans of these finishes are also available on tablex.com, but because of variations in monitor and printer calibration we do not suggest specifying without seeing a physical sample.

F2
Flat

F3
Bevel

F4
Radius

F5
Slope

Pattern Thermofoils	
661156	Folkstone Grey
661157	Aged Porcelain
661158	Icicle

Woodgrain Thermofoils			
651233	Walnut	661166	Cinnamon Stick
661150	Cocoa Pecan	661167	Brown Sugar
661152	Ganache	661168	Nutmeg
661153	Warm Honey	661169	Shiplap
661155	Sable	661170	Porch Swing
661159	Orange Wood	661171	Silver Birch
661160	Auburn	661172	Sterling
661161	Cider	661173	Bearwood
661162	Tawny	661174	Denmark
661163	Java	661175	Slate Hearth
661164	Sequoia	661212	Norway
661165	Colonial		

No-Drip Groove

All five thermofoil edges are available with a "no-drip" groove. Simply add ".G" to the edge and add \$50 to the list price of the table.

Example: F1.G

Waterfall edge with groove

Coordinating Solid Finishes

Standard Base Colors		Solid Laminates		Solid 3mm PVC Edges		PVC Knife Edges Colors	
02	Black	1595-60	Black	2416	Black	K1595	Black
10	Silhouette			015	Charcoal		
11	Smoke			001	Medium Grey		
15	Stone	D96-60	Shadow				
19	Foundry			7044	Foundry		
23	Phantom			3018	Shark	K91	Slate Grey
24	Linen			354	Designer White	K354	Designer White
34	Iron Alloy			3020	Iron Alloy		
35	Sand			1096	Pepperdust		
36	Espresso			3021	Espresso	K495	Coffee Bean
		1572-60	Antique White	1572	Antique White		

Coordinating Woodgrain Finishes

Wood Edge Finishes		Woodgrain Laminates		Woodgrain PVC Edges		Reed Woodgrain PVC Edges	
SE	Spice	7122T-07	Empire Mahogany	F3023	Empire Mahogany	R3023	Empire Mahogany
AD	Almond	10776-60	Kensington Maple	10776	Kensington Maple		
		7933K-07	Cafelle	F3026	Cafelle	R3026	Cafelle
		7943-07	Colombian Walnut	FTX089	Colombian Walnut	RTX089	Colombian Walnut
		7054-60	Wild Cherry	7054-60	Wild Cherry		
		7946-60	Brazilwood	7946-60	Brazilwood		
		7965K-12	Walnut Heights	TX103	Walnut Heights		
		7960K-18	Studio Teak	TX104	Studio Teak		

Veneer tops with wood edges

Veneer tops (with a 2mm wood edge) are available on most tables that are listed in the price list with a 3mm wood rim. These tables are listed in the 3W column. To specify these tables, just add a "+VNR" to the end of the model number, and the corresponding veneer upcharge listed for the top shapes below. If a table is listed as "NA" in the 3W column, it is not available in veneer as well.

To specify:

To specify these tables, just add a "VNR" to the end of the model number. Then add the corresponding veneer upcharge listed below to the list price in the 3W column.

Example:





01TC2460T20-3W-VNR
Foundation 24x60" table
3W column + VNR upcharge
\$834 + 1,300 = **\$2,134** List Price

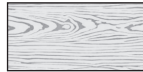



Veneer Finishes	
AD	Almond
BH	Butterscotch
BV	Black Velvet
CI	Cocoa Infusion
CT	Chestnut
NG	Nutmeg
SE	Spice





3W+VNR
Wood Edge + Veneer









rectangle						boat-shaped		racetrack		elliptical	
18 x 30	1,100	30 x 36	1,210	48 x 60	1,830	30 x 42 x 84	1,980	36 x 60	1,670	30 x 54	1,480
18 x 36	1,100	30 x 48	1,290	48 x 72	2,030	30 x 42 x 90	1,970	36 x 72	1,750	30 x 60	1,580
18 x 48	1,130	30 x 60	1,470	48 x 84	2,280	30 x 42 x 96	2,080	36 x 84	1,830	36 x 60	1,650
18 x 60	1,080	30 x 72	1,590	48 x 90	2,320	36 x 48 x 84	2,170	36 x 90	1,790	36 x 72	1,800
18 x 72	1,140	30 x 84	1,640	48 x 96	2,450	36 x 48 x 90	2,160	36 x 96	1,880	36 x 84	1,890
18 x 84	1,250	30 x 90	1,610	48 x 120	2,780	36 x 48 x 96	2,280	42 x 84	2,020	36 x 90	1,850
18 x 90	1,200	30 x 96	1,690	48 x 144	3,150	36 x 48 x 120	2,550	42 x 90	2,010	36 x 96	1,940
18 x 96	1,290	36 x 48	1,420	54 x 60	2,020	36 x 48 x 144	2,830	42 x 96	2,120	42 x 72	1,960
20 x 36	1,090	36 x 60	1,530	54 x 72	2,200	48 x 54 x 120	2,820	42 x 120	2,130	42 x 84	2,070
20 x 48	1,070	36 x 72	1,710	54 x 84	2,370	48 x 54 x 144	3,140	42 x 144	2,360	42 x 90	2,060
20 x 60	1,160	36 x 84	1,800	54 x 90	2,460	54 x 60 x 120	2,990	48 x 84	2,060	42 x 96	2,170
20 x 72	1,240	36 x 90	1,810	54 x 96	2,550	54 x 60 x 144	3,350	48 x 90	2,190	42 x 120	2,200
20 x 84	1,240	36 x 96	1,910	54 x 120	2,920			48 x 96	2,320	42 x 144	2,440
20 x 90	1,240	42 x 60	1,680	54 x 144	3,320			48 x 120	2,580	48 x 72	2,090
20 x 96	1,280	42 x 72	1,860	60 x 72	2,320			48 x 144	2,870	48 x 84	2,340
24 x 36	1,150	42 x 84	2,000	60 x 84	2,510			54 x 120	2,690	48 x 90	2,240
24 x 48	1,200	42 x 90	2,020	60 x 90	2,610			54 x 144	2,950	48 x 96	2,370
24 x 60	1,300	42 x 96	2,130	60 x 96	2,700			60 x 120	2,890	48 x 120	2,660
24 x 72	1,390	42 x 120	2,340	60 x 120	3,130			60 x 144	3,190	48 x 144	2,960
24 x 84	1,440	42 x 144	2,660	60 x 144	3,570						
24 x 90	1,410										
24 x 96	1,460										

													
square		round		squirle		half round		D-shaped					
24 x 24	990	24 x 24	1,120	24 x 24	990	18 x 36	1,060	24 x 36	1,280	42 x 60	1,770		
30 x 30	1,060	30 x 30	1,180	30 x 30	1,060	24 x 48	1,270	24 x 48	1,330	42 x 72	1,870		
36 x 36	1,180	36 x 36	1,300	36 x 36	1,170	30 x 60	1,500	24 x 60	1,370	42 x 84	1,860		
42 x 42	1,320	42 x 42	1,420	42 x 42	1,350	36 x 72	1,830	24 x 72	1,420	42 x 90	1,900		
48 x 48	1,490	48 x 48	1,640	48 x 48	1,510			24 x 84	1,460	42 x 96	1,940		
54 x 54	1,660	54 x 54	1,780					24 x 90	1,490	48 x 60	1,910		
60 x 60	1,850	60 x 60	2,140					24 x 96	1,510	48 x 72	2,020		
								30 x 48	1,400	48 x 84	2,140		
								30 x 60	1,490	48 x 90	2,190		
								30 x 72	1,550	48 x 96	2,250		
								30 x 84	1,640	54 x 54	1,750		
								30 x 90	1,690	54 x 60	1,950		
								30 x 96	1,720	54 x 72	2,150		
								36 x 48	1,530	54 x 84	2,290		
								36 x 60	1,610	54 x 90	2,350		
								36 x 72	1,700	54 x 96	2,420		
								36 x 84	1,780	54 x 120	2,700		
								36 x 90	1,820	54 x 144	3,010		
								36 x 96	1,860	60 x 60	2,060		
										60 x 72	2,270		
										60 x 84	2,450		
										60 x 90	2,530		
										60 x 96	2,600		
										60 x 120	2,910		
										60 x 144	3,280		

							
crescent		trapezoid		corner		arc segment	
24 x 48 x 75	1,980	24 x 48	1,270	24 x 42	850	20 x 44	970
24 x 60 x 94	2,670	24 x 72	1,250	30 x 48	1,030	24 x 51	1,080
30 x 60 x 94	2,790	30 x 60	1,280			30 x 59	1,320
		36 x 72	1,560			36 x 67	1,430

							
quarter round		ganging wedge		video wedge		transition	
20 x 20	930	20 x 20	850	20 x 20 x 40	890	20 x 30	1,000
24 x 24	1,020	24 x 24	940	24 x 24 x 48	1,010	24 x 30	1,030
30 x 30	1,150	30 x 30	1,020	30 x 30 x 60	1,150	30 x 30	1,050
36 x 36	1,270	36 x 36	1,150	36 x 36 x 72	1,240	36 x 30	1,060

											
trident		quadrant		bulb		teardrop		table desk		kidney bean	
36 x 36 x 18	1,080	60 x 60 x 18	1,710	24 x 24 x 18	900	24 x 48	NA	37 x 60	1,420	18 x 30	NA
40 x 40 x 20	1,120	60 x 60 x 20	1,730	30 x 30 x 20	1,010			42 x 78	1,730	18 x 36	NA
48 x 48 x 24	1,430	60 x 60 x 24	1,740	36 x 36 x 24	1,090					20 x 30	NA
60 x 60 x 30	1,910	60 x 60 x 30	1,830	42 x 42 x 30	1,200					20 x 36	NA
				48 x 48 x 36	1,460						

Nesting T-bases

Rectangular and half-round tables nest and stow with ease. These tables are noted in the pricer by an "NE" at the end of the model number.

Top sizes and shapes vary slightly by series. Rectangular nesting tables larger than 30x66" use a two-handed release.

Locking casters

All nesting T-base models are already priced to include 2" locking casters.

Staggered Nesting Dimensions

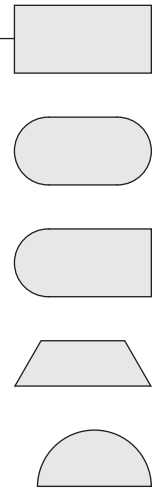
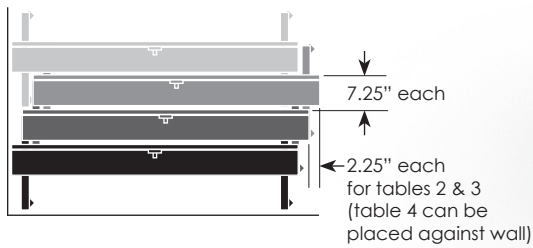

	00 - Ultra	01 - Foundation	02 - Fundamental	06 - Stretch	08 - Elite	33 - Element	44 - Primary	45 - Puddle	71 - Exclaim	74 - VerifiGo	88 - Next	99 - Surge
Nesting Options												
nesting T	•	•	•	•	•				•	•	•	

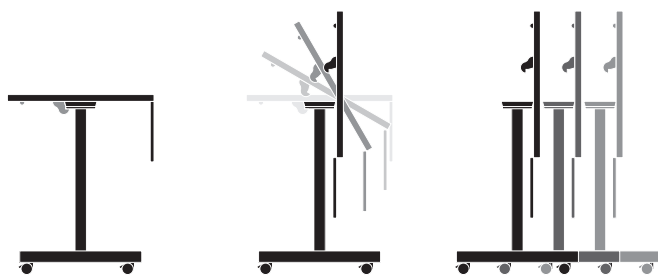

Nesting TT-bases

Large square and round tables don't have to be cumbersome. These tables become easily mobile using our two-handed TT nesting. These tables are noted in the pricer by an "NE" at the end of the model number.

This mechanism is used on 60" & 54" rounds, 48" squares, and 42x60" - 48x72" rectangles & D-shapes. Availability varies slightly by base series.

Locking casters

All nesting TT-base models are already priced to include 3" locking casters.

Staggered Nesting Dimensions

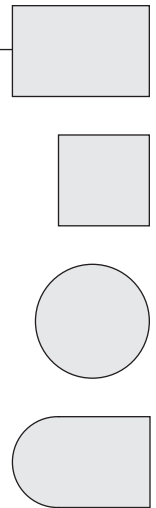
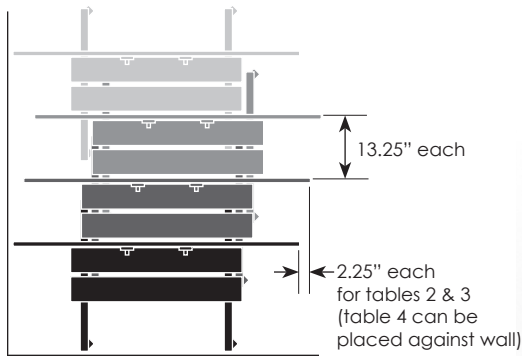

Nesting Options		00 - Ultra	01 - Foundation	02 - Fundamental	06 - Stretch	08 - Elite	33 - Element	44 - Primary	45 - Puddle	71 - Exclaim	74 - VeriGo	88 - Next	99 - Surge
nesting TT		•	•	•	•					•	•		

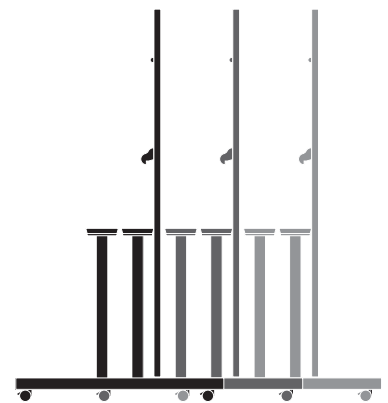
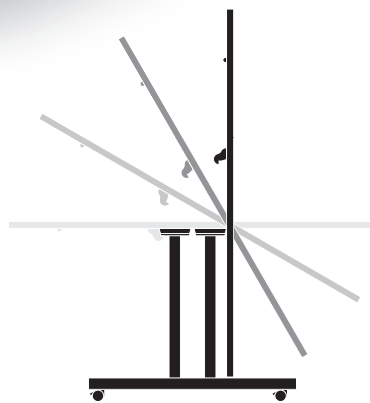

Flip Top X-bases and H-bases

Flip top tables can be a great space saver. These tables are noted in the pricer by an "FT" at the end of the model number.

Round & Square

Availability varies by series. Other options, such as casters, may dictate which sizes are available.

Rectangle & Kidney Bean

Available on VertiGo series H-based tables.

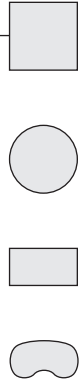

	00 - Ultra	01 - Foundation	02 - Fundamental	06 - Stretch	08 - Elite	33 - Element	44 - Primary	45 - Puddle	71 - Exclaim	74 - VertiGo	88 - Next	99 - Surge
Nesting Options												
flip top X		•	•	•	•	•				•	•	•
nesting X											•	

Next nesting X-bases
The Next series has the unique ability to nest X-base tables with Flip Tops. These tables are priced and listed as "nesting" tables with 3" locking casters. See page 172.

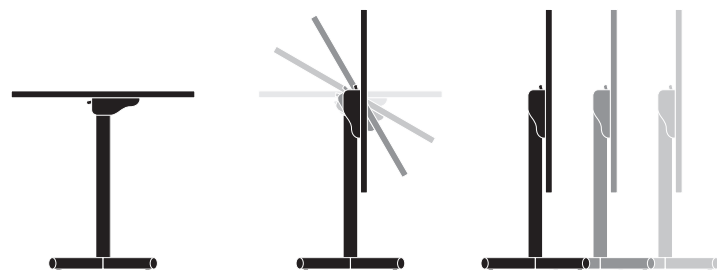

Folding T-bases and TT-bases

Rectangular, racetrack, and some round tables fold for easy storage. These tables are noted in the pricer by an "FD" at the end of the model number.

Standard Folding

Racetrack and rectangular tables 60" and longer use two standard folding mechanisms. Bases fold toward each other and end up toe-to-toe for a total thickness of 4.75" per table.

Short Folding

All round tables and any rectangular tables 48" long or less use a short fold mechanism. Bases fold one over the other for a total thickness of 6.75" per table.

Storage Table Carts

Carts to help store and move tables are available. See pricing below.

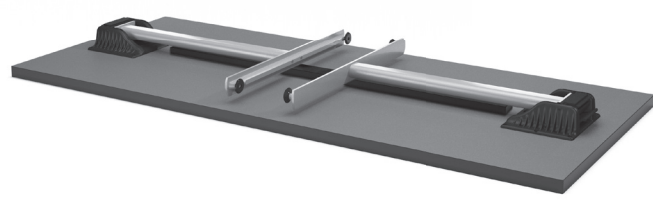
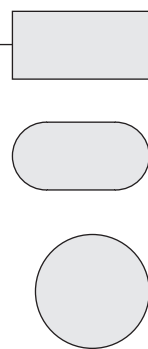

	00 - Ultra	01 - Foundation	02 - Fundamental	06 - Stretch	08 - Elite	33 - Element	44 - Primary	45 - Puddle	71 - Exclaim	74 - VeriGo	88 - Next	99 - Surge
Folding Option												
folding T	•	•	•	•	•							•
folding TT	•	•	•	•	•							

standard folding

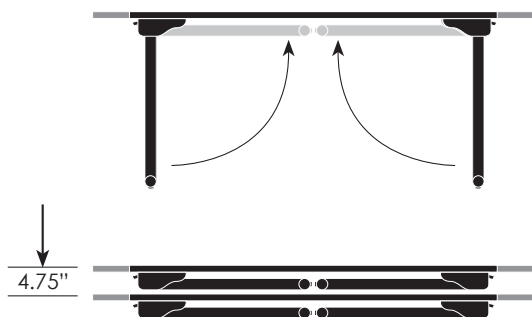

short folding

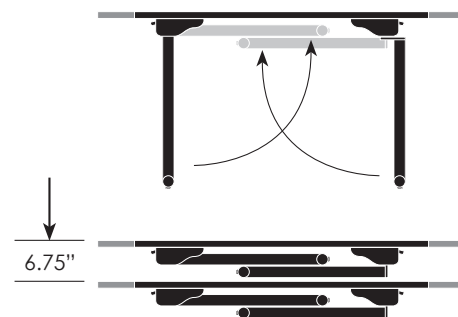

Folding Table Carts

Table Shape	Max Table	Capacity	Model Number	Finish	Price	Mobile Carts
Round	60"	Four short-fold tables	STC-RD60	01 Structured Black	\$ 1,180	
Rectangle	30 x 60"	Six folding tables	STC-TC60	01 Structured Black	1,307	
	30 x 72"	Six folding tables	STC-TC72	01 Structured Black	1,307	
	30 x 84"	Six folding tables	STC-TC84	01 Structured Black	1,391	
	30 x 96"	Six folding tables	STC-TC96	01 Structured Black	1,391	

RC Radius Corners

3" radius corners soften the corner of tables to give them a smooth feel. Upcharge is \$55.

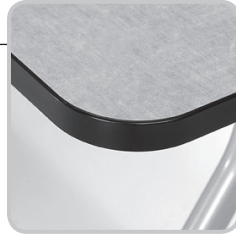

LT Lightweight Tops

Great for use on folding tables, these tops are 40% lighter than our standard tops. Constructed of a bass-wood core with Luan faces. Available only on tables with a standard 3mm PVC edge. Upcharge is \$115.



GR Grommets

Grommets can be added to most table shapes for an upcharge of \$40 each. Simply add "-GR" to your model number. 60 mm radius hole. Available in black. See page 150 for location details.



Markerboard Laminates

White markerboard laminate, Pionite SW844 High Gloss Bright White can be specified on any table for an upcharge of \$100 per table. We suggest pairing this with a dark 3mm edge. There are other markerboard laminates available from Formica & Pionite. Call customer service for custom quotes on those laminates.



new

CM Cable Manager

Cable managers can be added to most table shapes for an upcharge of \$50 each. Available in black. See page 150 for location details.

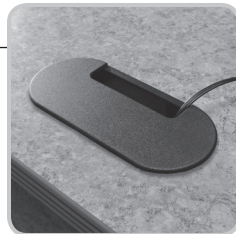

Modesty & Privacy Panels

Modesty & privacy panels can be added to many table sizes, and some can also be used on folding and nesting models.

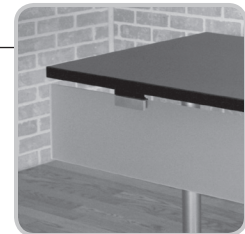

Available in laminate, metal, frosted acrylic, and mesh. See pages 190-193 for complete selection and pricing.

Solid Surface Tops

Need something a little more substantial? We can offer solid surface tops on many of our tables. These are quite popular on disc and X-based cafe tables. Call customer service for a custom quote. Leadtime on solid surface is usually around 5-6 weeks.

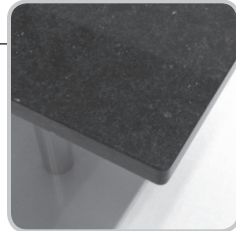

PHK Purse Hooks

Accessory hooks are great for hanging coats and purses. This is a simple add on item that works on practically any table. \$10 list each.



new

GN Ganging

Ganging brackets can be added to most tables for a \$40 upcharge. Note that some top shapes are already priced with ganging brackets included. Two plates and 8 knobs are shipped per table.

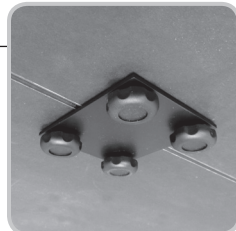

Custom Logo Tops

Make your laminate table top the focal point of any room by adding your logo in full color. Working with Wilsonart, we can add logos that utilize standard laminates into the background and integrate them into the logos themselves.



new

Tables are drilled to gang side-to-side. If face-to-face or another custom configuration is needed please supply a drawing with your purchase order.

This process requires a custom quote, and does require an extended leadtime, but the final results are worth it.

LC Locking Casters

2" locking casters can be added to most tables for an upcharge of \$90. Check product details for availability.

Note: nesting tables are priced with locking casters included.



WM Built In Wire Manager

One of two bases will have a 1x19" steel access door with self closing hinges. Door height can vary depending on other specified options. Check series details for availability. Upcharge is \$125. See page 202 for details.



CCG Concealed Casters

Concealed casters can be specified on one side of a T-based table. Other side will have standard glides. Overall height remains at 29". Upcharge is \$120.

Only available on Foundation, Fundamental, & Element series. (Foundation uses black end cap as pictured.)

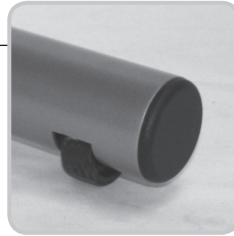

WMLC Snap-on Wire Management Leg Cover

Snaps on to round columns and offers coverage of wires down the leg. Powdercoated steel to match base color. Check series details for compatibility. Upcharge is \$45. See page 202 for details.

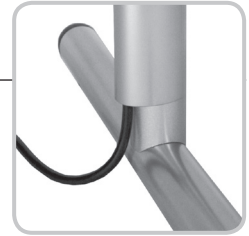

OS Offset T-bases

Most T-bases can be upgraded to offset T-bases. The standard offset is 3". Check product details for availability. Upcharges vary based on series.

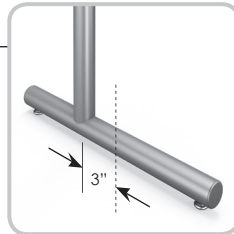

MMLC Magnetic Wire Management Leg Cover

Magnetically attaches to rectangular and square columns and offers coverage of wires down the leg. Powdercoated steel to match base color. Check series details for compatibility. Upcharge is \$55. See page 202 for details.



new

CH Chrome Finish

Chrome finish is a premium finish available on select models. Check product details for availability. Upcharges vary based on series and number of bases.



PB Powerbox Mounting Plate

The powerbox is ideal for round and square tables that have a power unit centered in the top. This U-shaped mounting plate allows 2.75x8x12" for the unit itself, and wire management through the column. Available on most X-bases and disc bases for \$125 upcharge.



new

EM Edge Mounted T-bases

T-Bases and TT-Bases can be specified as edge mounted bases on most static models for \$50. Bases on tables 36-48" in length are already edge mounted.

The position of bases on folding and nesting tables cannot be adjusted.

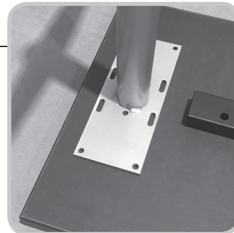

Fully Customized Tables

Have a customer asking for something a bit outside the box? We pride ourselves in finding ways to solve problems that other manufacturers walk away from. Call customer service and let us know what you need, and how we can help create a table just for you.



table length	EM
36-48"	standard
60-96"	\$50

SH Special Height

Special height tables can be specified in most series. Standard height is 29". Upcharges vary based on base and height needed.

Tables larger than 36x72" will need a stretcher bar between the bases. Contact customer service to quote these tables.

When specifying, include your custom height in the model number. For example: (-SH.42) for special height of 42".

base	< 29"	> 29"
X-base	+ 30	+ 65
disc base	+ 30	+ 65
two T-bases	+ 65	+ 130
two TT-bases	+ 130	+ 260
four columns	+ 130	+ 260
X.4 base	+ 130	+ 260

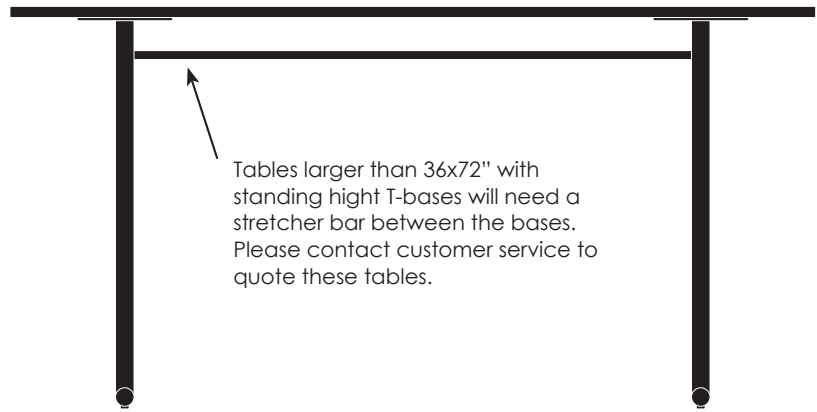
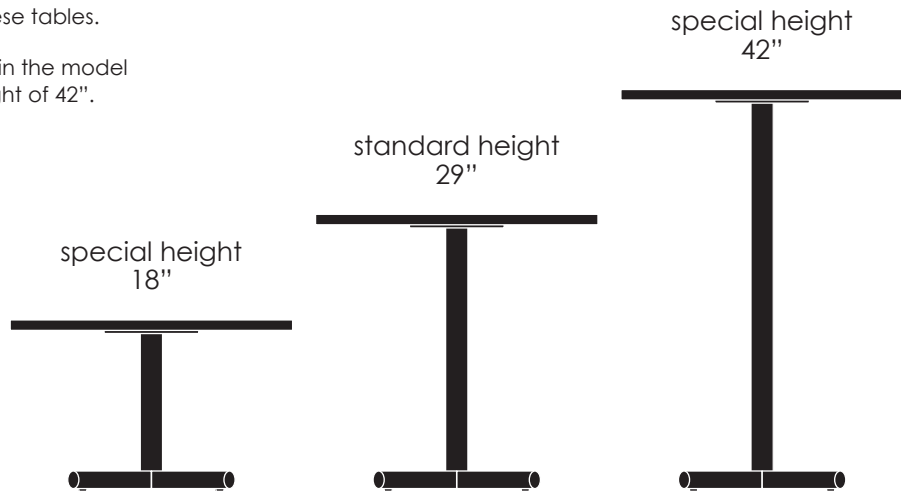

Tables larger than 36x72" with standing high T-bases will need a stretcher bar between the bases. Please contact customer service to quote these tables.

FR Footring

A footring is available on disc bases and select X-bases that are at standing height. Check product details for availability. Upcharge is \$150. Not available in chrome.

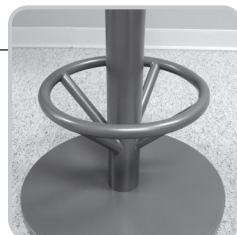



EH Electric

Electric height adjustability gives you the height range as the counter balanced, but is available in a wider variety of top shapes and sizes. The memory keypad remembers your four favorite heights. Available in both VertiGo & Surge.



	00 - Ultra	01 - Foundation	02 - Fundamental	06 - Stretch	08 - Elite	33 - Element	44 - Primary	45 - Puddle	71 - Exclaim	74 - VertiGo	88 - Next	99 - Surge
Height Adjustable Options												
spring clip		●	●	●	●		●					●
ratchet		●	●							●		
counter bal.		●	●				●			●		●
short bal.		●	●				●			●		●
pneumatic		●	●				●	●			●	
hand crank										●		
electric										●		●

BL Counter balanced

Need to get the most out of your height adjustable tables? The counter balanced option is the way to go. Simply squeeze the small handle underneath and gently move the top to your desired height. With a range over 17" and infinite choices in between, it's just that easy.

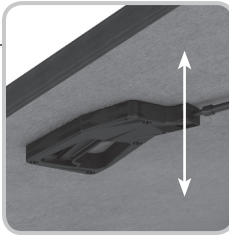

BLS Short Balanced

Go from coffee table height to standard height with the Short Balanced. Simply squeeze the small handle underneath and gently move the top to your desired height. Approximately 18-29".

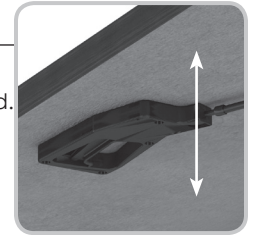

new

CR Hand Crank

Need the flexibility of infinite adjustability without the budget for counter balanced bases? Our manual hand crank offers a cost-effective alternative. Only available in the VertiGo series, but is available on some nesting models.



NU Pneumatic

Most square (max 36") and round (max 42") tables are available with pneumatic height adjustability. 12" range in 1" increments. Upcharge is \$350 on X and disc bases.

base	NU
X-base	\$350
T-base	\$700

Also available on select T-bases in Foundation & Fundamental for \$700, including some nesting models.

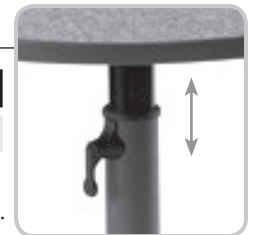

RA Ratchet

Ratchet height adjustability is available on select VertiGo, Foundation, & Fundamental tables. With a range of 9.45" the ratchet works in thirteen increments of .78". To reset to the lowest position, just lift past its highest point. Ratchet height adjustable bases are also available on some nesting tables.

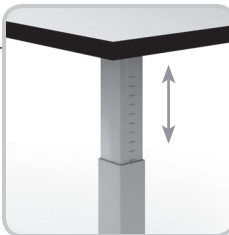

AH Spring Clip

A spring clip height adjustment mechanism is available on most tubular bases. See each series for availability. Height adjustment range is 26-32".

base	AH
X-base	\$125
T-base	\$250
columns	\$500

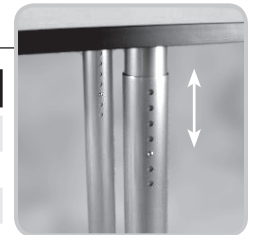





Not available on tables larger than 42" round or 36" square.





General Guidelines





- Allow about 30" /person
- Allow 48" for aisles between tables. ADA has 36" min.
- Allow 96"-120" between presenter and front row.
- Rooms with only one entrance are restricted to accommodate a maximum of 50 people (per fire code).
- Space required for single wheelchair passage is 36" min.
- Space required for double wheelchair passage is 60" min.
- Space required to turn a wheelchair is 60" dia.
- ADA Minimum table depth of 24".
- Newer wheelchair arms are designed to fit under NOTE: 45 and 60 degree standard 29"h tables (older models require an extra 2.5" of clearance)
- Ganging Wedges are not recommended for seating if top is not supported by a base.
- Capacities are based upon a 30" minimum width per seat. This chart is only a guideline which can vary based upon seating design and table layout.









rectangle		boat-shaped		racetrack		elliptical					
18 x 30	1	30 x 36	2	48 x 60	6	30 x 42 x 84	6 - 8	36 x 60	4	30 x 54	4
18 x 36	1	30 x 48	2 - 4	48 x 72	6 - 8	30 x 42 x 90	8	36 x 72	4	30 x 60	4
18 x 48	1	30 x 60	4	48 x 84	6 - 8	30 x 42 x 96	8 - 10	36 x 84	6	36 x 60	4
18 x 60	2	30 x 72	6	48 x 90	8	36 x 48 x 84	6 - 8	36 x 90	8	36 x 72	4
18 x 72	3	30 x 84	6	48 x 96	8 - 10	36 x 48 x 90	8	36 x 96	6 - 8	36 x 84	6
18 x 84	4	30 x 90	6	48 x 120	10 - 12	36 x 48 x 96	8 - 10	42 x 84	6 - 8	36 x 90	8
18 x 90	4	30 x 96	8	48 x 144	12	36 x 48 x 120	10 - 12	42 x 90	8	36 x 96	6 - 8
18 x 96	4 - 5	36 x 48	2 - 4	54 x 60	6	36 x 48 x 144	12	42 x 96	8 - 10	42 x 72	6
20 x 36	2	36 x 60	4 - 6	54 x 72	8	48 x 54 x 120	10 - 12	42 x 120	10 - 12	42 x 84	6 - 8
20 x 48	2	36 x 72	6 - 8	54 x 84	8	48 x 54 x 144	12	42 x 144	12	42 x 90	8
20 x 60	2 - 3	36 x 84	6 - 8	54 x 90	8	54 x 60 x 120	10 - 12	48 x 84	6 - 8	42 x 96	8 - 10
20 x 72	3	36 x 90	8	54 x 96	8 - 10	54 x 60 x 144	12	48 x 90	8	42 x 120	10 - 12
20 x 84	4	36 x 96	8 - 10	54 x 120	10 - 12			48 x 96	8 - 10	42 x 144	12
20 x 90	4	42 x 60	6 - 8	54 x 144	12			48 x 120	10 - 12	48 x 72	6
20 x 96	4 - 5	42 x 72	6 - 8	60 x 72	8			48 x 144	12	48 x 84	6 - 8
24 x 36	1	42 x 84	6 - 8	60 x 84	8			54 x 120	10 - 12	48 x 90	8
24 x 48	1	42 x 90	8	60 x 90	8			54 x 144	12	48 x 96	8 - 10
24 x 60	2	42 x 96	8 - 10	60 x 96	8 - 10			60 x 120	10 - 12	48 x 120	10 - 12
24 x 72	3	42 x 120	10 - 12	60 x 120	10 - 12			60 x 144	12	48 x 144	12
24 x 84	4	42 x 144	12	60 x 144	12						
24 x 90	4										
24 x 96	4 - 5										

				 <i>new</i>							
square		round		squirle		half round		D-shaped			
24 x 24	2	24 x 24	2	24 x 24	2	18 x 36	1 - 2	24 x 36	1	42 x 60	5 - 7
30 x 30	2	30 x 30	2	30 x 30	2	24 x 48	2	24 x 48	1	42 x 72	5 - 7
36 x 36	4	36 x 36	3	36 x 36	4	30 x 60	3	24 x 60	2	42 x 84	5 - 7
42 x 42	4	42 x 42	4	42 x 42	4	36 x 72	4	24 x 72	3	42 x 90	7
48 x 48	4	48 x 48	4 - 5	48 x 48	4			24 x 84	3	42 x 96	7 - 9
54 x 54	4 - 8	54 x 54	5					24 x 90	3	48 x 60	5 - 7
60 x 60	4 - 8	60 x 60	6 - 7					24 x 96	2 - 3	48 x 72	5 - 7
								30 x 48	2 - 3	48 x 84	5 - 7
								30 x 60	3	48 x 90	7
								30 x 72	5	48 x 96	7 - 9
								30 x 84	5	54 x 54	4
								30 x 90	5	54 x 60	6
								30 x 96	7	54 x 72	8
								36 x 48	2 - 3	54 x 84	8
								36 x 60	3 - 5	54 x 90	8
								36 x 72	5 - 7	54 x 96	8 - 10
								36 x 84	5 - 7	54 x 120	10 - 12
								36 x 90	7	54 x 144	12
								36 x 96	7 - 9	60 x 60	6
										60 x 72	8
										60 x 84	8
										60 x 90	8
										60 x 96	8 - 10
										60 x 120	10 - 12
										60 x 144	12

							
crescent		trapezoid		corner		arc segment	
24 x 48 x 75	2	24 x 48	4 - 5	24 x 42	1	20 x 44	2
24 x 60 x 94	2	24 x 72	4 - 5	30 x 48	1	24 x 51	2
30 x 60 x 94	4	30 x 60	4 - 5			30 x 59	2
		36 x 72	4 - 5			36 x 67	2

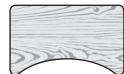
							
quarter round		ganging wedge		video wedge		transition	
20 x 20	0	20 x 20	0	20 x 20 x 40	2	20 x 30	0
24 x 24	1	24 x 24	0	24 x 24 x 48	2	24 x 30	1
30 x 30	1	30 x 30	1	30 x 30 x 60	2	30 x 30	1
36 x 36	1	36 x 36	1	36 x 36 x 72	2	36 x 30	1

											
trident		quadrant		bulb		teardrop		table desk		kidney bean	
36 x 36 x 18	3	60 x 60 x 18	4	24 x 24 x 18	2	24 x 48	4	37 x 60	1	18 x 30	1
40 x 40 x 20	3	60 x 60 x 20	4	30 x 30 x 20	2			42 x 78	1	18 x 36	1
48 x 48 x 24	3	60 x 60 x 24	4	36 x 36 x 24	2					20 x 30	1
60 x 60 x 30	3	60 x 60 x 30	4	42 x 42 x 30	3					20 x 36	1
				48 x 48 x 36	3						