

Metal pop-up units



Each of our metal pop-up units feature a single touch door opening which closes when not in use. These units are available in a multitude of configurations balancing your need for conventional (15 amp/125 volt) power with USB power and data jacks.

Finishes: Choose between Black and Anodized Aluminum.

Cord: Choose between 72" and 120" length. All feature 15 amp/125 volt. Some units require two cords.

Cutout: You do not need to specify a grommet or add any upcharge to your table price. The cost of the cutout is included in the price of the unit.

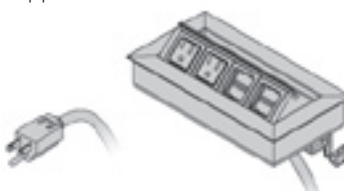
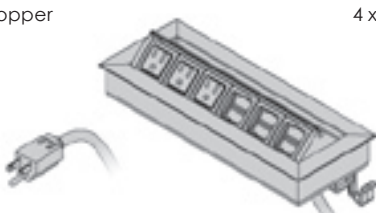

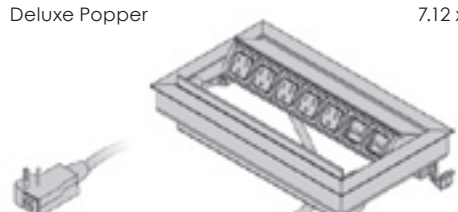
Product	Approx. Size	Power / Data	Cord	Model Number	BL	AA
 Twin Popper	4 x 5"	2 Power	72"	PD04-2P-72	\$ 219	\$ 219
			120"	PD04-2P-120	228	228
		1 Power + 1 Data	72"	PD04-1P-1D-72	208	208
			120"	PD04-1P-1D-120	217	217
		1 Power + 1 USB	72"	PD04-1P-1U-72	279	279
			120"	PD04-1P-1U-120	288	288
 Quad Popper	4 x 8"	4 Power	72"	PD06-4P-72	509	398
			120"	PD06-4P-120	518	407
		2 Power + 2 Data	72"	PD06-2P-2D-72	404	318
			120"	PD06-2P-2D-120	413	327
		2 Power + 2 USB	72"	PD06-2P-2U-72	475	389
			120"	PD06-2P-2U-120	484	397
 Hex Popper	4 x 11"	6 Power	72"	PD14-6P-72	595	464
			120"	PD14-6P-120	606	473
		3 Power + 3 Data	72"	PD14-3P-3D-72	443	348
			120"	PD14-3P-3D-120	452	356
		4 Power + 2 USB	72"	PD14-4P-2U-72	675	559
			120"	PD14-4P-2U-120	684	567
 Butterfly Popper	8 x 8"	8 Power	72"	PD08-8P-72	943	733
			120"	PD08-8P-120	961	750
		4 Power + 4 Data	72"	PD08-4P-4D-72	805	626
			120"	PD08-4P-4D-120	823	644
		4 Power + 4 USB	72"	PD08-4P-4U-72	1,087	908
			120"	PD08-4P-4U-120	1,105	926
 Deluxe Popper	7.12 x 12.5"	7 Power	72"	PD10-7P-72	734	572
			120"	PD10-7P-120	743	581
		5 Power + 2 Data	72"	PD10-5P-2D-72	620	484
			120"	PD10-5P-2D-120	629	493
		5 Power + 2 USB	72"	PD10-5P-2U-72	762	625
			120"	PD10-5P-2U-120	770	634

NEW

Power/Data

Budget units



These units are designed with an eye on the fixed budget. They are available in a multitude of configurations balancing your need for conventional (15 amp/125 volt) power with USB power and data jacks.

Finishes: Only available in Black.

Cord: Choose between 72" and 120" length. All feature 15 amp/125 volt. Some units require two cords.

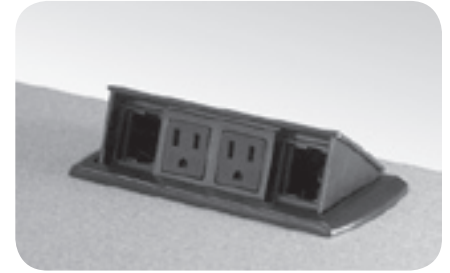
Cutout: You do not need to specify a grommet or add any upcharge to your table price. The cost of the cutout is included in the price of the unit.

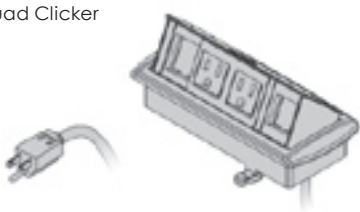

Product	Approx. Size	Power / Data	Cord	Model Number	BL
Quad Clicker 	3 x 6"	2 Power + 2 Data	72"	PD02-2P-2D-72	\$ 179
			120"	PD02-2P-2D-120	188
Mushroom Hub 	4 x 4"	4 Power	72"	PD13-4P-72	208
			120"	PD13-4P-120	225
		2 Power + 2 Data	72"	PD13-2P-2D-72	169
			120"	PD13-2P-2D-120	178
		4 Data	NA	PD13-4D	130

new

Villa™ Daisylink™ System



The Villa Daisylink system is a 4 wire, 2 circuit hardwire system which allows for non-sequential plug and play use. Link up to 20 single kits or 10 double kits in a row using one of three power infeed options.

Some minor assembly is required, but holes are routed and predrilled for easy installation. An electrician is required when using the hardwire power infeed.

Grommets: Specify Lift (-L) or Flush (-F).

Finishes: Specify Black (-BL) or Silver (-SV).

Lift & Flush Units: You do not need to specify a grommet or add any upcharge to your table price. The cost of the cutout is included in the price of the unit on all -F and -L models.

Undermount Units: -U models are mounted with outlets facing downward and do not have grommets. If you desire a standard grommet to access these outlets, you must specify them. See page 157 for standard grommet information.

Infeeds: You must specify a power infeed unit for each row or grouping of tables. The number of kits that can be supported per row varies depending on the infeed specified.



Single Kit includes:

- 1 power base
- 1 FM cable
- 1 FF cable
- 4 cable clamps
- 1 grommet (on -L / -F models)



Double Kit includes:

- 2 power bases
- 1 FM cable
- 2 FF cable
- 6 cable clamps
- 2 grommets (on -L / -F models)

Villa Daisy Chain Kits	Top Length	Kit	Power / Data	Model Number	Finish	-L / -F	-U
	36"	Single	Power	V36SP-2P	-BL -SV	\$ 336	\$ 276
			Power / Data	V36SD-2P-2D	-BL -SV	425	365
	48"	Single	Power	V48SP-2P	-BL -SV	336	276
			Power / Data	V48SD-2P-2D	-BL -SV	425	365
	60"	Single	Power	V60SP-2P	-BL -SV	336	276
			Power / Data	V60SD-2P-2D	-BL -SV	425	365
Double		Power	V60DP-2P	-BL -SV	611	491	
		Power / Data	V60DD-2P-2D	-BL -SV	700	580	
72"	Single	Power	V72SP-2P	-BL -SV	336	276	
		Power / Data	V72SD-2P-2D	-BL -SV	425	365	
	Double	Power	V72DP-2P	-BL -SV	611	491	
		Power / Data	V72DD-2P-2D	-BL -SV	700	580	
84"	Single	Power	V84SP-2P	-BL -SV	408	348	
		Power / Data	V84SD-2P-2D	-BL -SV	498	438	
	Double	Power	V84DP-2P	-BL -SV	611	491	
		Power / Data	V84DD-2P-2D	-BL -SV	700	580	
90"	Single	Power	V90SP-2P	-BL -SV	421	361	
		Power / Data	V90SD-2P-2D	-BL -SV	511	451	
	Double	Power	V90DP-2P	-BL -SV	680	560	
		Power / Data	V90DD-2P-2D	-BL -SV	860	740	
96"	Single	Power	V96SP-2P	-BL -SV	425	365	
		Power / Data	V96SD-2P-2D	-BL -SV	515	455	
	Double	Power	V96DP-2P	-BL -SV	611	491	
		Power / Data	V96DD-2P-2D	-BL -SV	700	580	

new power base with outlets facing down for use without grommet: -U

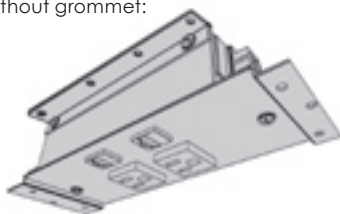

Grommet selection

Lift (-L)



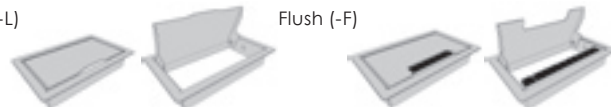

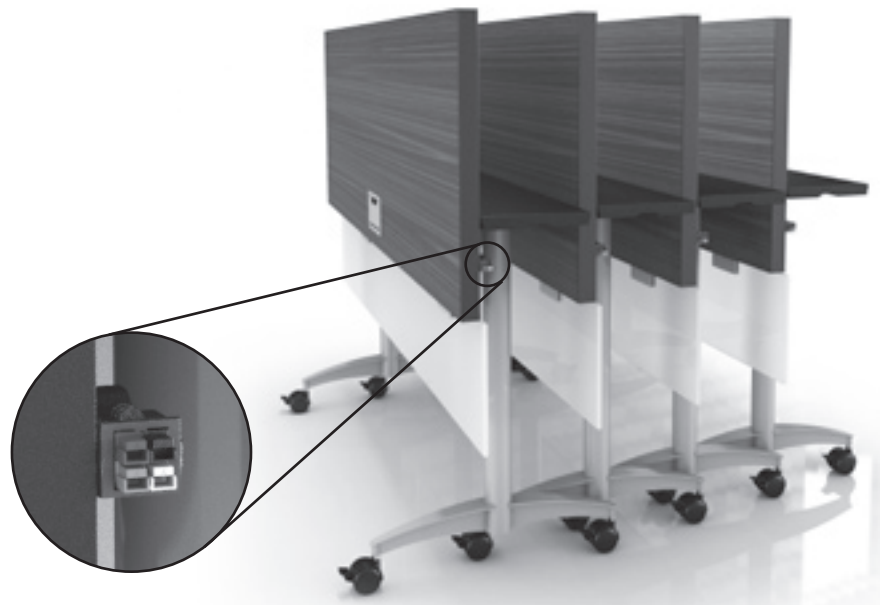

Flush (-F)

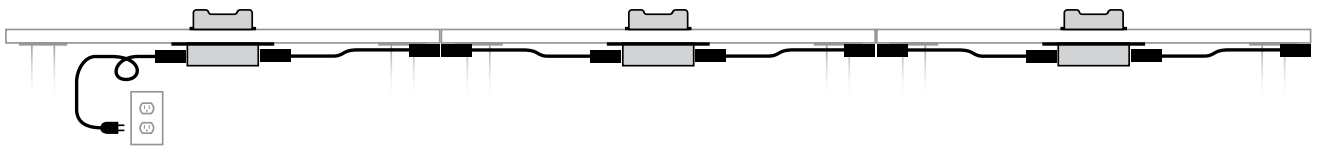

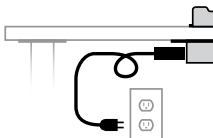

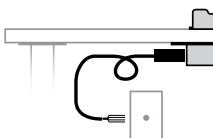
How does the **Villa Daisylink System** work?

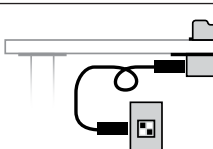

Unit	Description	Visual	Cord	Model Number	Price
15 AMP Plug Infeed 	- Standard 15 AMP straight plug can be plugged into any standard wall outlet. - Feeds up to 10 units.		72	VAP-72	\$ 166
			120	VAP-120	228
Hardwire Infeed 	- 2 circuit system hardwired into wall and plugs into first table in the row. - Feeds up to 20 units.		72	VHW-72	116
			120	VHW-120	178
Quick Disconnect Kit 	- Hardwired wall unit paired with an FF jumper unit which plugs into first table in the row. - Feeds up to 20 units.		72	VQD-72	204
			120	VQD-120	257
FM Jumper Unit 	- Great for linking tables around a corner, face to face, bypassing a non-powered table, or two tables that are not in perfect alignment.		12	VFM-12	70
			24	VFM-24	83
			36	VFM-36	96
			48	VFM-48	110
			60	VFM-60	123
			72	VFM-72	136

Power/Data

new

"Villa" and "Daisylink" are trademarks of Electri-Cable Assemblies.

Villa™ Corded System

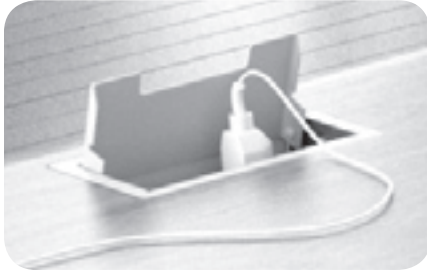

The Villa corded system

Some minor assembly is required, but holes are routed and predrilled for easy installation.

Grommets: Specify Lift (-L) or Flush (-F).

Finishes: Specify Black (-BL) or Silver (-SV).

Lift & Flush Units: You do not need to specify a grommet or add any upcharge to your table price. The cost of the cutout is included in the price of the unit on all -F and -L models.

Undermount Units: -U models are mounted with outlets facing downward and do not have grommets. If you desire a standard grommet to access these outlets, you must specify them. See page 157 for standard grommet informations.



One per table: If specifying one per table, the unit is centered.



Two per table: If specifying two per table, consider using a 36" cord on the second unit to minimize your cord management.

How does the Villa Corded System work?

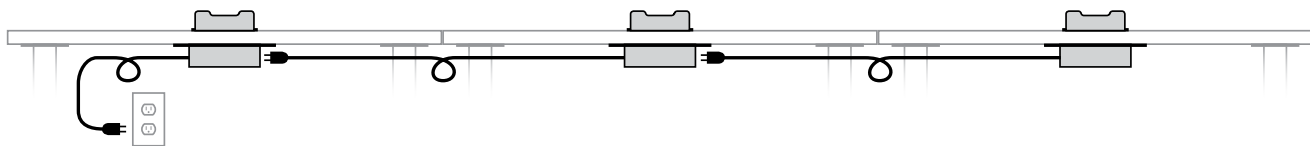

Villa Corded Units	Cord	Kit	Power / Data	Model Number	Finish	-L / -F	-U
power base with outlets facing up for use with Lift or Flush grommet: -L / -F	36"	Corded	Power	VC36P-2P	-BL -SV	\$ 246	\$ 186
			Power / Data	VC36D-2P-2D	-BL -SV	336	276
	72"	Corded	Power	VC72P-2P	-BL -SV	246	186
			Power / Data	VC72D-2P-2D	-BL -SV	336	276
	108"	Corded	Power	VC108P-2P	-BL -SV	246	186
			Power / Data	VC108D-2P-2D	-BL -SV	336	276



Grommet selection

Lift (-L)



Flush (-F)

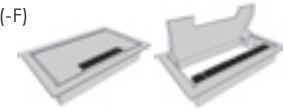

Power/Data

new

power base with outlets facing down for use without grommet: -U

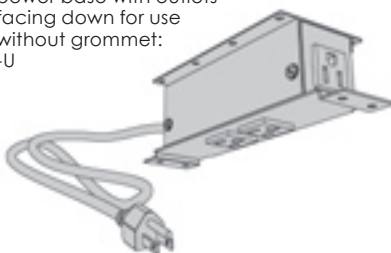

media sharing

Marina™ System

The Marina is a collaborative video conferencing solution that combines power with the necessary audiovisual components required to foster collaborative meeting environments between teams working together on site or connecting those associates working remotely. Ideal for use with our new D-shaped conference tables.

All technology components are packed neatly into one single package and are simply "dropped in" from the table top, eliminating installation and set-up hassles.

Retractable cabling keeps all cords neat when not in use – simply push the button and they retract back inside the unit.

Simple Sharing Capabilities – share one screen with up to four users with the simple push of a "Show Me" button.

Some minor assembly is required, but holes are routed and predrilled for easy installation.

Finishes: Specify BL (-BL) or Silver (-SV).

Cutout: You do not need to specify a grommet or add any upcharge to your table price. The cost of the cutout is included in the price of the unit.

Marina Includes:

- 4 retractable VGA cables
- 4 audio cables
- A/V box to switch from one VGA source to another
- 4 duplex power units
- 2 convenience receptacles
- 2 blank telecom plates for the ability to add capabilities
- 2 power cords, 72" length



Marina Units	2 Cords	Model Number	Finish	Price
	72"	MS-MAR-72	-BL -SV	\$ 9,376

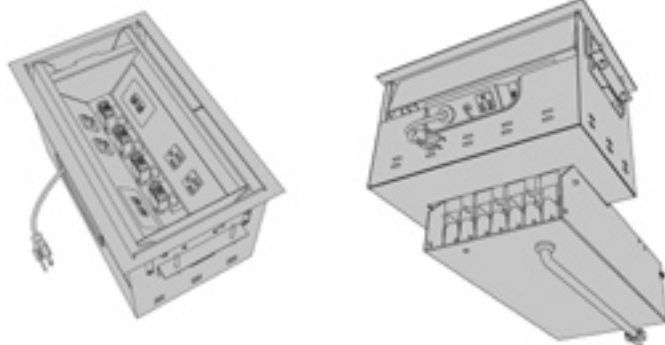

"Marina" is a trademark of Electri-Cable Assemblies.