

table



price list

effective January 1, 2018

18

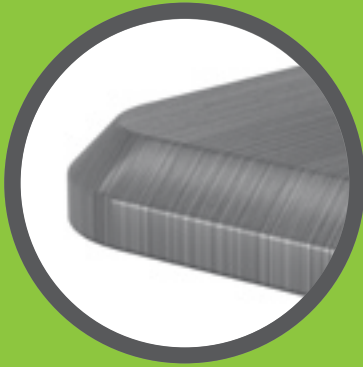

tableX



TableX is proud to release this new and improved price list. We've added new options, top shapes, and bases. We continue to look for ways to improve and expand our product line and bring better solutions to the market.

If at any time you have any questions, or need something above and beyond the models listed here, please don't hesitate to call. We are here to help you all the way.

TableX customer service: **877.481.1177**

Introduction	Page
pricing comparison	p. 2
terms & conditions	p. 4
<ul style="list-style-type: none"> <li>• pricing</li> <li>• orders</li> <li>• order acknowledgements</li> <li>• terms</li> <li>• lead times</li> <li>• modified product</li> <li>• cancellations &amp; returns</li> </ul>	
freight	p. 5
<ul style="list-style-type: none"> <li>• freight charges</li> <li>• shipping</li> </ul>	
sample purchase order	p. 6
warranty	p. 7
surface materials	p. 8
<ul style="list-style-type: none"> <li>• high pressure laminates</li> <li>• powdercoat base colors</li> <li>• 3mm pvc edges</li> <li>• 3mm pvc knife edges</li> <li>• wood edges</li> <li>• rigid thermofoil</li> <li>• coordinating finishes</li> <li>• veneer upcharges</li> </ul>	
table options	p. 16
<ul style="list-style-type: none"> <li>• nesting tables</li> <li>• folding tables</li> <li>• flip top tables</li> <li>• folding tables</li> <li>• top options</li> <li>• base options</li> <li>• custom height options</li> <li>• height adjustable options</li> </ul>	
seating capacities	p. 24

Product Pricing	p. 26
00 - Ultra series	p. 26
01 - Foundation series	p. 32
02 - Fundamental series	p. 48
06 - Stretch series	p. 64
08 - Elite series	p. 80
33 - Element series	p. 98
44 - Primary series	p. 114
45 - Puddle series	p. 134
71 - Exclaim series	p. 138
74 - Vertigo series	p. 150
88 - Next series	p. 172
99 - Surge series	p. 176
table accessories	p. 190
<ul style="list-style-type: none"> <li>• modesty panels</li> <li>• privacy panels</li> </ul>	
power / data	p. 194
<ul style="list-style-type: none"> <li>• metal pop-up units</li> <li>• budget units</li> <li>• Daisylink systems</li> <li>• Corded systems</li> </ul>	
wire management	p. 202
TableXpress quickship program	p. 204

## 24x60" rectangles

Something as simple as a 24x60" rectangular table can be specified many different ways. With 12 different standard series of bases, TableX has you covered. Use the matrix below to compare list pricing of each series, using a static, 24x60" rectangular table with a 3mm PVC edge.



**Ultra**  
p.26

\$816 List

**Foundation**  
p.32

\$619

**Fundamental**  
p.48

\$571

**Stretch**  
p.64

\$593

**Elite**  
p.80

\$720

**Element**  
p.98

\$609

**Primary**  
p.114

four columns  
\$660

**Primary**  
p.114

two 99 discs  
\$1,103

**Primary**  
p.114

two 44 discs  
\$1,336

**Puddle**  
p.134

two 45 discs  
\$1,156

**Exclaim**  
p.138

\$784

**VertiGo**  
p.150

\$638

**Next**  
p.172

\$866

**Surge**  
p.176











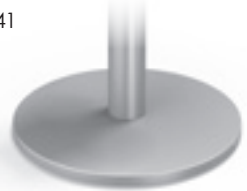

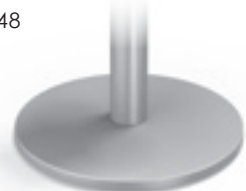

\$642



## 36" rounds

Cafe tables with X-bases and disc bases are everywhere. TableX offers a wide variety of bases that give you plenty of choices. Use the matrix below to compare list pricing of each series, using a static, 36" round table with a standard 3mm PVC edge.



<p><b>Foundation</b></p> <p>p.32</p>  <p>\$626 List</p>	<p><b>Foundation</b></p> <p>p.41</p>  <p>44 disc \$863</p>	<p><b>Fundamental</b></p> <p>p.48</p>  <p>\$578</p>	<p><b>Fundamental</b></p> <p>p.48</p>  <p>44 disc \$863</p>
<p><b>Stretch</b></p> <p>p.64</p>  <p>\$762</p>	<p><b>Elite</b></p> <p>p.80</p>  <p>\$731</p>	<p><b>Element</b></p> <p>p.98</p>  <p>\$735</p>	<p><b>Primary</b></p> <p>p.114</p>  <p>four columns \$654</p>
<p><b>Primary</b></p> <p>p.127</p>  <p>99 disc \$747</p>	<p><b>Primary</b></p> <p>p.127</p>  <p>44 disc \$863</p>	<p><b>Puddle</b></p> <p>p.134</p>  <p>45 disc \$774</p>	<p><b>VertiGo</b></p> <p>p.163</p>  <p>\$766</p>
<p><b>VertiGo</b></p> <p>p.163</p>  <p>74 disc \$776</p>	<p><b>Next</b></p> <p>p.172</p>  <p>\$705</p>	<p><b>Surge</b></p> <p>p.176</p>  <p>\$702</p>	<p><b>Surge</b></p> <p>p.183</p>  <p>99 disc \$747</p>

## Pricing

All prices quoted are list prices, FOB our warehouse. All documentation and literature is based on the most recent information available at the time of this publication. We reserve the right to make product improvements and design enhancements at any time, without notice. Prices are subject to change without notification.

## Orders

All orders must be received in writing with complete information. See page 14 for a sample purchase order and a checklist of information that is required to place an order.

E-mail orders to:  
**sales@tablex.com**

Fax orders to:  
**812.481.1178**

Duplicate orders that are not marked as such are the responsibility of the customer.

## Order Acknowledgements

Orders are acknowledged upon receipt at TableX. No order shall be binding upon TableX until we confirm it with an acknowledgement. The customer bears sole responsibility for order correctness. All orders will be manufactured and invoiced in accordance with the acknowledgement. Customers must notify TableX in writing of any discrepancy **within 5 days**. Any subsequent change order is dependent upon our ability to accommodate the specification, terms and status of the order in production, and may be subject to additional charges for labor, material and other costs involved.

## Terms

Terms are Net 30 days from the date of invoice. Payment is due when invoice is issued and is considered delinquent if not paid within 30 days. Interest will be charged at the rate of 1.5% per month on delinquent accounts. TableX does not create or provide statements.

## Lead Times

Lead times can vary based on product availability, fluctuations in busy season, and national holidays. Please contact customer service at 877.481.1177 for current lead times.

Note: Selecting certain options (wood edges, chrome bases, or thermofoil tops) can impact lead time. Below are estimated lead times based on normal business conditions.

Laminate	Edge	Base	Standard Lead Time
<i>TableXpress Program</i>			<i>5-day quickship</i>
<b>standard</b>	<b>3mm PVC</b>	<b>standard</b>	<b>4-5 weeks</b>
rigid thermofoil tops			4-6 weeks
solid surface tops			4-6 weeks
	3mm wood		6-8 weeks
	1.25" wood		6-8 weeks
		chrome	6-8 weeks

## Modified Product

TableX prides itself on providing you with product that exceeds your expectations. Sometimes your needs are outside the standard product offering. Our flexibility as a small company allows us to accommodate requests for non-cataloged product. Contact Customer Service at 877.481.1177 to discuss your unique product requirements and we'll help you meet your needs.

## Cancellations & Returns

Our acceptance of an order is final and binding and not subject to cancellation by the customer. No merchandise may be returned without the written consent of TableX.

## Freight Charges

TableX is located in Jasper, Indiana. All shipping zones are based on proximity to our facility.

### Minimum Orders

Standard freight charges apply to any order under \$3,000 total list price shipping within the continental United States. The standard charge for each zone is shown below, based on the total list price of the order.

### Tiered Freight Program

These freight charges are reduced or waived on orders based on their total list price. The qualifying list prices for each zone are shown below.

## Shipping

All shipments are F.O.B., dock-to-dock from our warehouse. Charges for additional services such as lift gates, non-commercial deliveries, inside deliveries, etc. are the responsibility of the buyer and may be charged to the buyer after the date of delivery.

Legal responsibility for the product transfers to the buyer upon acceptance by the carrier. Damaged, lost or shorted shipments are the responsibility of the carrier. Inspect all shipments promptly upon arrival and note any damage or loss on the delivery receipt. If damage is concealed, keep the packing and notify the carrier immediately for an inspection. Carriers require such reports within 5 days of delivery. Failure to report damage or loss is the consignee's responsibility. The freight charges may be collect to the receiver, billed to the purchaser, or prepaid by TableX.

### Freight Claims

Legal title to merchandise passes to the buyer upon acceptance by the carrier. All cartons must be carefully inspected upon delivery for visible and concealed damage. If concealed damage has occurred, the carrier must be notified within (5) days. All of our product is thoroughly inspected before it leaves the factory, therefore it is the buyer's responsibility to seek recourse against the carrier.

- online updates
- new product
- clarification / edit
- deletion

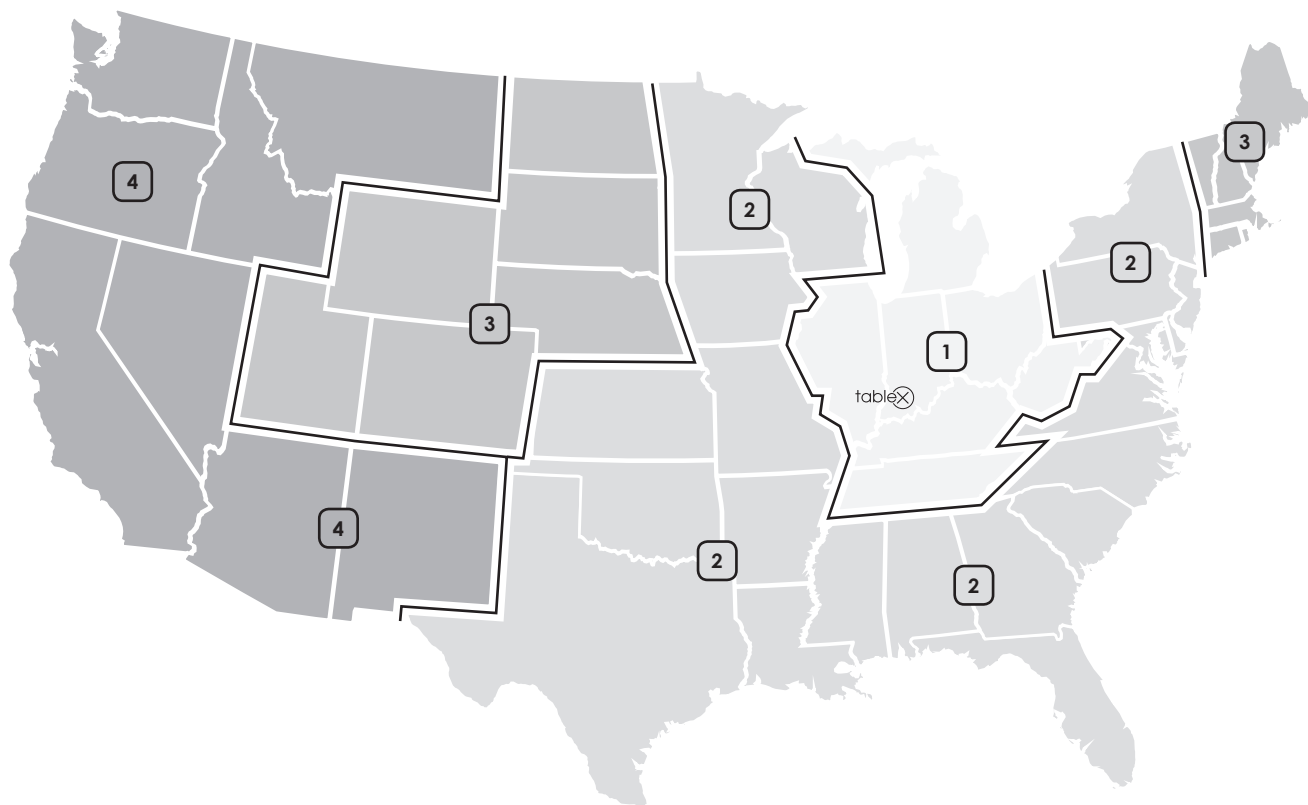

Zone	Destination State	Total List Price / Freight Charge				
		< \$3K	> \$3K	> \$5K	> \$7.5K	> \$10K
1	IL, IN, KY, MI, OH, TN, WV	\$100	free freight			
2	AL, AR, DE, FL, GA, IA, KS, LA, MD, MN, MO, MS, NC, NJ, NY, OK, PA, SC, TX, VA, WI	\$200	\$100	free freight		
3	CO, CT, MA, ME, ND, NE, NH, RI, SD, UT, VT, WY	\$250	\$200	\$100	free freight	
4	AZ, CA, ID, MT, NM, NV, OR, WA	\$300	\$250	\$200	\$100	free

**Email orders to:**  
sales@tablex.com

**Fax orders to:**  
812.481.1178

When sending in a purchase order, be sure to include the following items. Each of these is important in ensuring that your order is processed accurately and in a timely manor.



Furniture Dealer  
123 Main St.  
Middletown, US 12345

ph. 123.456.7890  
fax 123.456.7890

## PURCHASE ORDER

page 1 of 1

PO #	Date
12-34567-89	06 / 01 / 2018

**your PO #**

we will include this on your order acknowledgement for easy tracking.

TO: TableX  
555 Cathy Lane  
Jasper, IN 47546

SHIP TO: Furniture Dealer  
123 Main St.  
Middletown, US 12345

**'ship to' address**  
check page 3 to see how location will effect freight charges.

Line	Quantity	Model # / Description	Unit Price	Ext. Price
		Special Intructions: Call 24 hours before delivery: James Abbott, 123.456.7890 Dealer contact: Peter Gray, 123.456.7890		
1	12	01TC2460T22NE-3P-GR.A - 7960K-18/3021/08 Foundation 24x60" rectangular table with 22" wide T-bases. NE: nesting with locking casters GR.A: 1 grommet in location A List Price: \$1,116 Discount: 50/10  Laminate: Wilsonart 7960K-18 Studio Teak 3P: 3MM EDGE: 3021 Espresso BASE: 08 Structured Chocolate  TAG: training room	502.20	6,026.40
2	5	08RD48X36-W2 - 7054-60/NG/21 Elite 48" round table with 36" wide X-base. List Price: \$1,460 Discount: 50/10  Laminate: Wilsonart 7054-60 Wild Cherry W2: WOOD EDGE: NG Nutmeg BASE: 21 Silver Frost  TAG: break room	657.00	3,285.00
Freight			0.00	0.00
Total order amount				9,311.40

**special instructions**  
this includes but is not limited to a requested delivery date, call before delivery, dealer contact, and tagging instructions.

**complete model #**  
include any options and your surface materials.

**list price & discount**  
this is important so that we can double check any options and upcharges.

**surface materials**  
double check to make sure these are included. this is the piece most often left off of a PO.

**freight charges**  
many larger orders qualify for free freight. reference the chart on page 3 to verify your costs.

- **line item #**  
makes cross referencing much easier if we have any questions.
- **quantity**  
exactly how many of these do you need?
- **product tagging**  
we will include this on the label underneath each table.



## Warranty

effective January 1, 2018

TableX merchandise limited warranty on the original purchase covers normal use for 50 years from date of shipment against defect with workmanship and materials.

Electrical components are covered for 1 year. Moving components; such as, but not exclusive to; flip top mechanisms and height adjustment mechanisms are covered for 5 years. Note of exception on Nesting Extrusions, warranty is 10 years.

Wood veneers, Formica, Wilsonart, Pionite, and Nevamar laminates, and rigid thermofoil laminates are covered by the specified surface manufacturer under their particular warranty only. TableX does not promote laminate "self edge" tops due to their tendency to be damaged during everyday use. Self edge tops are done by special request only, and are covered for 1 year.

Finishes, when exposed to ultraviolet rays, may change color. Desktop accessories with rubber or plastic feet can penetrate or burn a finish. These issues are not warranted and will not be the responsibility of TableX.

### Exclusions include:

- Normal wear and tear over course of ownership or abuse beyond originally intended use of product.
- Modifications or additions to the product, or final product assembly that is not TableX approved.
- Product used for rental purposes
- Damage caused by misapplication of cleaning chemicals or improper use of core and cleaning procedures.
- Surface materials damaged by excessive humidity or dryness in an uncontrolled environment.

Any repairs or modifications by the customer must receive specific written authorization from TableX prior to being executed.

In no event shall liability under this warranty exceed the original purchase price of the product.

## High Pressure Laminates

### Standard Laminates

TableX stocks over 50 laminates. With a large selection of patterns, solids, and woodgrains, these laminates are all available at standard pricing.

### Special Laminates

TableX also offers Wilsonart, Nevamar, Pionite, and Formica laminates. In most cases, if it is part of their standard offering, it can be used at standard pricing. Please check with customer service if you have a question regarding any special laminates.

### TableXpress Quickship Program

When ordering TableXpress quickship products, you must select from our standard list of stocked laminates.

### Samples

Laminate samples are available by request. Scans of these laminates are also available on [tablex.com](http://tablex.com) for reference, but because of variations in monitor and printer calibration we do not suggest specifying without seeing a physical sample.



Pattern Laminates		Solid Laminates		Woodgrain Laminates	
299-58	Ebony Oxide	D96-60	Shadow	7054-60	Wild Cherry *
4552-60	Ebony Star	D315-60	Platinum	7122K-07	Empire Mahogany *
4621-60	White Nebula	D354-60	Designer White	7933K-07	Cafelle *
4622-60	Grey Nebula	D355-60	Gunmetal	7943K-07	Colombian Walnut *
4623-60	Graphite Nebula	D439-60	Wallaby	7946-38	Brazilwood *
4656-60	Bronze Legacy	1500-60	Grey	7960K-18	Studio Teak *
4668-60	Mushroom Tigris	1573-60	Frosty White	7965K-12	Walnut Heights *
4779-60	Pewter Brush	1595-60	Black	10776-60	Kensington Maple *
4783-60	White Tigris	D91-60	Slate Gray		
4810-60	Titanium Ev	D381-60	Fashion Grey		
4811-60	Silicon Ev	D431-60	Alabaster		
4813-60	Nickel Ev	899-58	Desert Beige		
4814-60	Tungsten Ev	928-58	Mouse		
4820-60	Carbon Ev	7197-58	Dover White		
4841-60	Desert Zephyr	8751-58	Mojave		
4842-60	Canyon Zephyr				
4843-60	Misted Zephyr				
4844-60	Loden Zephyr				
4846-60	Morro Zephyr				
4876-38	Sheer Mesh				
4879-38	Steel Mesh				
4942-38	Crisp Linen				
6220-58	Smoke Quarstone				
6729-58	Paloma Bisque				
7708-58	Flax Gauze				
8830-58	Elemental Concrete				
AT951	Neutral Santos				
MR6008T	Birch Matrix				
PO7001T	Paris White Potteryware				

\* Matching standard 3mm edge available.

## Powdercoat Base Colors

### Standard Powdercoat Finishes

TableX offers 26 different powdercoat finishes. Most product lines are available in the full offering of powdercoat colors. Check the series intro for any product specific limitations.

### Chrome

Chrome is available on many of our table lines for a standard upcharge per table. Please check the series intro for availability. Also note that chrome bases add 3-4 weeks to the standard leadtime.

### \*Brushed Steel & Ruby

Brushed Steel and Ruby are only available on the models that are available in chrome... but without the upcharge. Check series intro for availability.

### Samples

Paint samples are available by request. Scans of these paint colors are also available on [tablex.com](http://tablex.com) for reference, but because of variations in monitor and printer calibration we do not suggest specifying without seeing a physical sample.



Standard Powdercoat Finishes					
01	Structured Black	17	Creme	30	Pearl
02	Black	19	Foundry	31	Sun Gold
05	Structured Slate	21	Silver Frost	33	Moonstone
06	Structured Concrete	23	Phantom	34	Iron Alloy
08	Structured Chocolate	24	Linen	35	Sand
10	Silhouette	25	Storm	36	Espresso
11	Smoke	28	Oyster	37	Satin Silver
15	Stone	29	Flint	38	Tungsten Metallic

Premium Finishes	
CH	Chrome
03	Brushed Steel *
32	Ruby *

## 3mm PVC Edges

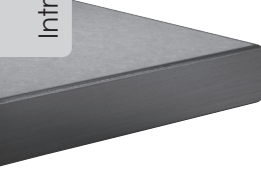

**3P**  
Flat



**3P**  
Reed

### Standard Edges

TableX stocks 11 solid edge colors and 21 woodgrain edges. Seven of those woodgrain edges are also available as a reeded edge.

**TableXpress** Quickship Program: When ordering TableXpress quickship products, you must select from our standard list of 3mm PVC edges. Knife edge is not available.

### Samples

Edge samples are available by request. Scans of these edges are also available on Tablex.com for reference, but because of variations in monitor and printer calibration we do not suggest specifying without seeing a physical sample.

### Solid 3mm PVC Edges

001	Medium Grey
015	Charcoal
016	Haze
D354	Designer White
1096	Pepperdust
480	Antique White
2416	Black
3018	Shark
3020	Iron Alloy
3021	Espresso
7044	Foundry

### Woodgrain PVC Edges

TX091	Bayshore Maple	7054	Wild Cherry *
TX093	Amaretto Maple	7946	Brazilwood
TX095	Bramble Walnut	10776	Kensington Maple *
TX096	Molasses Cherry	FTX087	Coastal Maple
TX098	Dusk Walnut	FTX089	Colombian Walnut *
TX102	Fireberry	F3022	Warm Cherry
TX103	Walnut Heights *	F3023	Empire Mahogany *
TX104	Studio Teak *	F3024	Traditional Cherry
TX108	Cashew Rift	F3025-2	Blonde Maple 2
TX109	Chestnut Rift	F3026	Cafelle *
TX110	Ashen Rift		

### Woodgrain Reed Edges

RTX087	Coastal Maple
RTX089	Colombian Walnut *
R3022	Warm Cherry
R3023	Empire Mahogany *
R3024	Traditional Cherry
R3025-2	Blonde Maple 2
R3026	Cafelle *

\* Matching standard laminate available.

## 3mm PVC Knife Edges

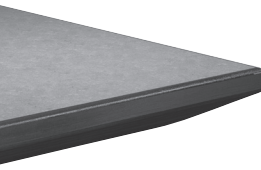

**3K**  
Knife

### Knife Edges

Any standard 3mm edge is available as a knife edge. Simply specify the 3mm edge and also specify the paint color for the exposed MDF core. There are six colors available. Each is based on a Wilsonart solid laminate color of the same name.

### PVC Knife Edges Core Colors

K91	Slate Grey
K315	Platinum
K354	Designer White
K439	Wallaby
K495	Coffee Bean
K1595	Black



## Wood Edges

Please check top shape for availability. Also note that wood edges add 3-4 weeks to the standard leadtime.

**TableXpress** Quickship Program  
Wood edged tops are not available on our TableXpress program.

### Care & Maintenance

Clean all surfaces with water-dampened soft cloth in the direction of the grain. Quickly buff dry.

Immediately remove any liquids that come in contact with the wood surfaces using a blotting action to absorb the liquid. Lift objects to move them. Never pull them across the finished surface. Avoid exposing furniture to extreme heat and cold or to wide humidity variances.

Avoid exposing furniture to strong sunlight. Exposure to sunlight over time will cause finish variation. Do not use soaps, commercial cleaners or harsh solvents as they will cause finish deterioration. If using a protective glass top, place spacer pads under the glass top to allow the wood to breathe.

### Samples

Wood finish samples are available by request. Scans of these finishes are also available on [tablex.com](http://tablex.com) for reference, but because of variations in monitor and printer calibration we do not suggest specifying without seeing a physical sample.

Wood Edge Finishes					
AD	Almond	CI	Cocoa Infusion	NG	Nutmeg
BH	Butterscotch	CT	Chestnut	SE	Spice
BV	Black Velvet				

**W1**  
Bullnose

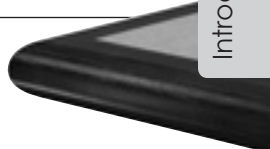

**W2**  
Square



**W3**  
Fluted

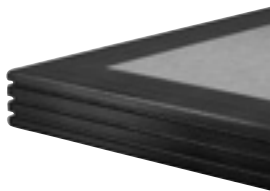

**W4**  
Reverse



**3W**  
Flat



## Rigid Thermofoil

**F1**  
Waterfall

### Standard Thermofoils

TableX offers a variety of thermofoil patterns to choose from. Please check [tablex.com](http://tablex.com) for the most up-to-date product offering.

Please check top shape for availability. Also note that thermofoil tops add 3-4 weeks to the standard leadtime.

### Care & Maintenance

Cleaners such as, alcohol, benzene, and non-abrasive household detergents can be used. The practice of using any solvent based or abrasive type cleaners is not recommended. TableX recommends the use of a soft, clean cloth when cleaning the Rigid Thermofoil surfaces.

### Corners

All thermofoil tops come with a standard 1" radius on all corners. The optional 3" radius is available for \$55 list upcharge.

### TableXpress Quickship Program

Rigid Thermofoil tops are not available on our TableXpress program.

### Samples

TableX thermofoil sample books are available by request. Scans of these finishes are also available on [tablex.com](http://tablex.com), but because of variations in monitor and printer calibration we do not suggest specifying without seeing a physical sample.

**F2**  
Flat

**F3**  
Bevel

**F4**  
Radius

**F5**  
Slope

Pattern Thermofoils	
661156	Folkstone Grey
661157	Aged Porcelain
661158	Icicle

Woodgrain Thermofoils			
651233	Walnut	661166	Cinnamon Stick
661150	Cocoa Pecan	661167	Brown Sugar
661152	Ganache	661168	Nutmeg
661153	Warm Honey	661169	Shiplap
661155	Sable	661170	Porch Swing
661159	Orange Wood	661171	Silver Birch
661160	Auburn	661172	Sterling
661161	Cider	661173	Bearwood
661162	Tawny	661174	Denmark
661163	Java	661175	Slate Hearth
661164	Sequoia	661212	Norway
661165	Colonial		

### No-Drip Groove

All five thermofoil edges are available with a "no-drip" groove. Simply add ".G" to the edge and add \$50 to the list price of the table.

Example: F1.G

Waterfall edge with groove

## Coordinating Solid Finishes

Standard Base Colors		Solid Laminates		Solid 3mm PVC Edges		PVC Knife Edges Colors	
02	Black	1595-60	Black	2416	Black	K1595	Black
10	Silhouette			015	Charcoal		
11	Smoke			001	Medium Grey		
15	Stone	D96-60	Shadow				
19	Foundry			7044	Foundry		
23	Phantom			3018	Shark	K91	Slate Grey
24	Linen			354	Designer White	K354	Designer White
34	Iron Alloy			3020	Iron Alloy		
35	Sand			1096	Pepperdust		
36	Espresso			3021	Espresso	K495	Coffee Bean
		1572-60	Antique White	1572	Antique White		

## Coordinating Woodgrain Finishes

Wood Edge Finishes		Woodgrain Laminates		Woodgrain PVC Edges		Reed Woodgrain PVC Edges	
SE	Spice	7122T-07	Empire Mahogany	F3023	Empire Mahogany	R3023	Empire Mahogany
AD	Almond	10776-60	Kensington Maple	10776	Kensington Maple		
		7933K-07	Cafelle	F3026	Cafelle	R3026	Cafelle
		7943-07	Colombian Walnut	FTX089	Colombian Walnut	RTX089	Colombian Walnut
		7054-60	Wild Cherry	7054-60	Wild Cherry		
		7946-60	Brazilwood	7946-60	Brazilwood		
		7965K-12	Walnut Heights	TX103	Walnut Heights		
		7960K-18	Studio Teak	TX104	Studio Teak		

## Veneer tops with wood edges

Veneer tops (with a 2mm wood edge) are available on most tables that are listed in the price list with a 3mm wood rim. These tables are listed in the 3W column. To specify these tables, just add a "+VNR" to the end of the model number, and the corresponding veneer upcharge listed for the top shapes below. If a table is listed as "NA" in the 3W column, it is not available in veneer as well.

### To specify:

To specify these tables, just add a "VNR" to the end of the model number. Then add the corresponding veneer upcharge listed below to the list price in the 3W column.

### Example:





01TC2460T20-3W-VNR  
Foundation 24x60" table  
3W column + VNR upcharge  
\$834 + 1,300 = **\$2,134** List Price

Veneer Finishes	
AD	Almond
BH	Butterscotch
BV	Black Velvet
CI	Cocoa Infusion
CT	Chestnut
NG	Nutmeg
SE	Spice





**3W+VNR**  
Wood Edge + Veneer







rectangle						boat-shaped		racetrack		elliptical	
18 x 30	1,100	30 x 36	1,210	48 x 60	1,830	30 x 42 x 84	1,980	36 x 60	1,670	30 x 54	1,480
18 x 36	1,100	30 x 48	1,290	48 x 72	2,030	30 x 42 x 90	1,970	36 x 72	1,750	30 x 60	1,580
18 x 48	1,130	30 x 60	1,470	48 x 84	2,280	30 x 42 x 96	2,080	36 x 84	1,830	36 x 60	1,650
18 x 60	1,080	30 x 72	1,590	48 x 90	2,320	36 x 48 x 84	2,170	36 x 90	1,790	36 x 72	1,800
18 x 72	1,140	30 x 84	1,640	48 x 96	2,450	36 x 48 x 90	2,160	36 x 96	1,880	36 x 84	1,890
18 x 84	1,250	30 x 90	1,610	48 x 120	2,780	36 x 48 x 96	2,280	42 x 84	2,020	36 x 90	1,850
18 x 90	1,200	30 x 96	1,690	48 x 144	3,150	36 x 48 x 120	2,550	42 x 90	2,010	36 x 96	1,940
18 x 96	1,290	36 x 48	1,420	54 x 60	2,020	36 x 48 x 144	2,830	42 x 96	2,120	42 x 72	1,960
20 x 36	1,090	36 x 60	1,530	54 x 72	2,200	48 x 54 x 120	2,820	42 x 120	2,130	42 x 84	2,070
20 x 48	1,070	36 x 72	1,710	54 x 84	2,370	48 x 54 x 144	3,140	42 x 144	2,360	42 x 90	2,060
20 x 60	1,160	36 x 84	1,800	54 x 90	2,460	54 x 60 x 120	2,990	48 x 84	2,060	42 x 96	2,170
20 x 72	1,240	36 x 90	1,810	54 x 96	2,550	54 x 60 x 144	3,350	48 x 90	2,190	42 x 120	2,200
20 x 84	1,240	36 x 96	1,910	54 x 120	2,920			48 x 96	2,320	42 x 144	2,440
20 x 90	1,240	42 x 60	1,680	54 x 144	3,320			48 x 120	2,580	48 x 72	2,090
20 x 96	1,280	42 x 72	1,860	60 x 72	2,320			48 x 144	2,870	48 x 84	2,340
24 x 36	1,150	42 x 84	2,000	60 x 84	2,510			54 x 120	2,690	48 x 90	2,240
24 x 48	1,200	42 x 90	2,020	60 x 90	2,610			54 x 144	2,950	48 x 96	2,370
24 x 60	1,300	42 x 96	2,130	60 x 96	2,700			60 x 120	2,890	48 x 120	2,660
24 x 72	1,390	42 x 120	2,340	60 x 120	3,130			60 x 144	3,190	48 x 144	2,960
24 x 84	1,440	42 x 144	2,660	60 x 144	3,570						
24 x 90	1,410										
24 x 96	1,460										

													
square		round		squirle		half round		D-shaped					
24 x 24	990	24 x 24	1,120	24 x 24	990	18 x 36	1,060	24 x 36	1,280	42 x 60	1,770		
30 x 30	1,060	30 x 30	1,180	30 x 30	1,060	24 x 48	1,270	24 x 48	1,330	42 x 72	1,870		
36 x 36	1,180	36 x 36	1,300	36 x 36	1,170	30 x 60	1,500	24 x 60	1,370	42 x 84	1,860		
42 x 42	1,320	42 x 42	1,420	42 x 42	1,350	36 x 72	1,830	24 x 72	1,420	42 x 90	1,900		
48 x 48	1,490	48 x 48	1,640	48 x 48	1,510			24 x 84	1,460	42 x 96	1,940		
54 x 54	1,660	54 x 54	1,780					24 x 90	1,490	48 x 60	1,910		
60 x 60	1,850	60 x 60	2,140					24 x 96	1,510	48 x 72	2,020		
								30 x 48	1,400	48 x 84	2,140		
								30 x 60	1,490	48 x 90	2,190		
								30 x 72	1,550	48 x 96	2,250		
								30 x 84	1,640	54 x 54	1,750		
								30 x 90	1,690	54 x 60	1,950		
								30 x 96	1,720	54 x 72	2,150		
								36 x 48	1,530	54 x 84	2,290		
								36 x 60	1,610	54 x 90	2,350		
								36 x 72	1,700	54 x 96	2,420		
								36 x 84	1,780	54 x 120	2,700		
								36 x 90	1,820	54 x 144	3,010		
								36 x 96	1,860	60 x 60	2,060		
										60 x 72	2,270		
										60 x 84	2,450		
										60 x 90	2,530		
										60 x 96	2,600		
										60 x 120	2,910		
										60 x 144	3,280		







  

							
crescent		trapezoid		corner		arc segment	
24 x 48 x 75	1,980	24 x 48	1,270	24 x 42	850	20 x 44	970
24 x 60 x 94	2,670	24 x 72	1,250	30 x 48	1,030	24 x 51	1,080
30 x 60 x 94	2,790	30 x 60	1,280			30 x 59	1,320
		36 x 72	1,560			36 x 67	1,430

							
quarter round		ganging wedge		video wedge		transition	
20 x 20	930	20 x 20	850	20 x 20 x 40	890	20 x 30	1,000
24 x 24	1,020	24 x 24	940	24 x 24 x 48	1,010	24 x 30	1,030
30 x 30	1,150	30 x 30	1,020	30 x 30 x 60	1,150	30 x 30	1,050
36 x 36	1,270	36 x 36	1,150	36 x 36 x 72	1,240	36 x 30	1,060

											
trident		quadrant		bulb		teardrop		table desk		kidney bean	
36 x 36 x 18	1,080	60 x 60 x 18	1,710	24 x 24 x 18	900	24 x 48	NA	37 x 60	1,420	18 x 30	NA
40 x 40 x 20	1,120	60 x 60 x 20	1,730	30 x 30 x 20	1,010			42 x 78	1,730	18 x 36	NA
48 x 48 x 24	1,430	60 x 60 x 24	1,740	36 x 36 x 24	1,090					20 x 30	NA
60 x 60 x 30	1,910	60 x 60 x 30	1,830	42 x 42 x 30	1,200					20 x 36	NA
				48 x 48 x 36	1,460						

## Nesting T-bases

Rectangular and half-round tables nest and stow with ease. These tables are noted in the pricer by an "NE" at the end of the model number.

Top sizes and shapes vary slightly by series. Rectangular nesting tables larger than 30x66" use a two-handed release.

### Locking casters

All nesting T-base models are already priced to include 2" locking casters.

### Staggered Nesting Dimensions

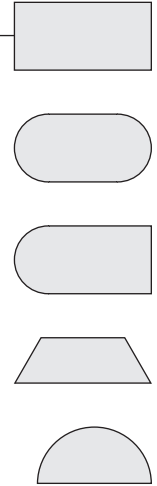
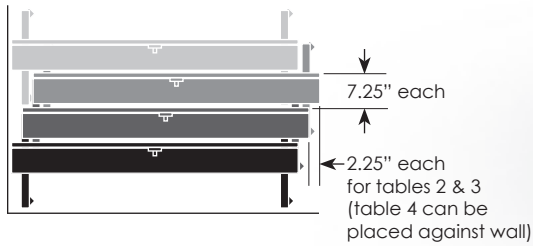

	00 - Ultra	01 - Foundation	02 - Fundamental	06 - Stretch	08 - Elite	33 - Element	44 - Primary	45 - Puddle	71 - Exclaim	74 - VerifiGo	88 - Next	99 - Surge
<b>Nesting Options</b>												
nesting T	•	•	•	•	•				•	•	•	

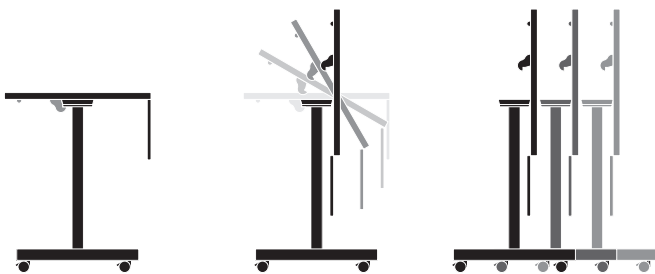

## Nesting TT-bases

Large square and round tables don't have to be cumbersome. These tables become easily mobile using our two-handed TT nesting. These tables are noted in the pricer by an "NE" at the end of the model number.

This mechanism is used on 60" & 54" rounds, 48" squares, and 42x60" - 48x72" rectangles & D-shapes. Availability varies slightly by base series.

### Locking casters

All nesting TT-base models are already priced to include 3" locking casters.

### Staggered Nesting Dimensions

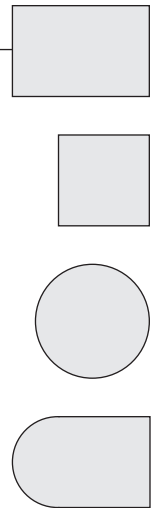
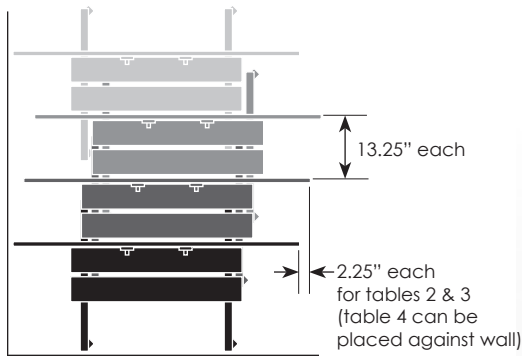

Nesting Options		00 - Ultra	01 - Foundation	02 - Fundamental	06 - Stretch	08 - Elite	33 - Element	44 - Primary	45 - Puddle	71 - Exclaim	74 - VeriGo	88 - Next	99 - Surge
nesting TT		•	•	•	•					•	•		

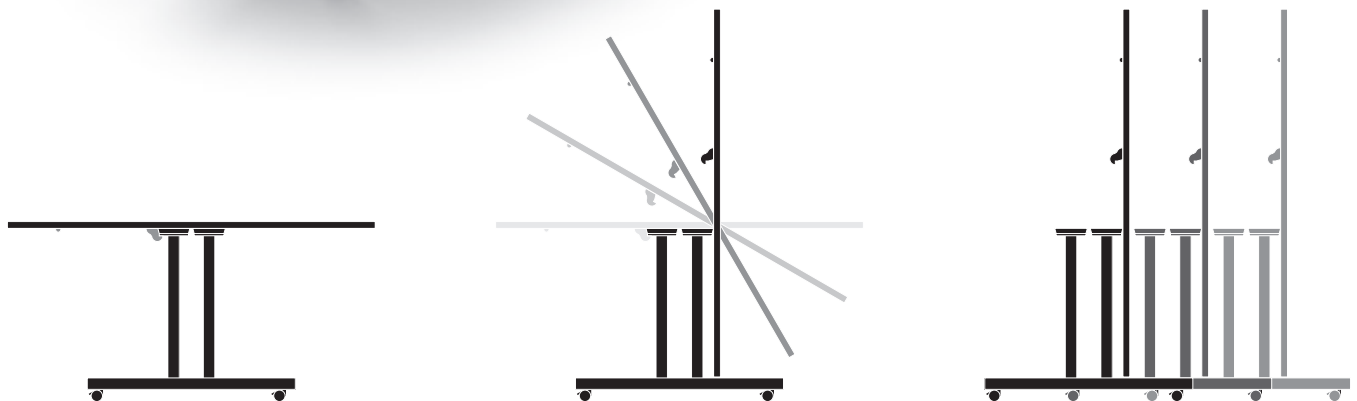

## Flip Top X-bases and H-bases

Flip top tables can be a great space saver. These tables are noted in the pricer by an "FT" at the end of the model number.

### Round & Square

Availability varies by series. Other options, such as casters, may dictate which sizes are available.

### Rectangle & Kidney Bean

Available on VertiGo series H-based tables.

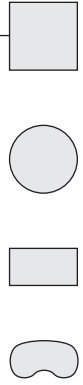

	00 - Ultra	01 - Foundation	02 - Fundamental	06 - Stretch	08 - Elite	33 - Element	44 - Primary	45 - Puddle	71 - Exclaim	74 - VertiGo	88 - Next	99 - Surge
<b>Nesting Options</b>												
flip top X		•	•	•	•	•				•	•	•
nesting X											•	

**Next nesting X-bases**  
The Next series has the unique ability to nest X-base tables with Flip Tops. These tables are priced and listed as "nesting" tables with 3" locking casters. See page 172.

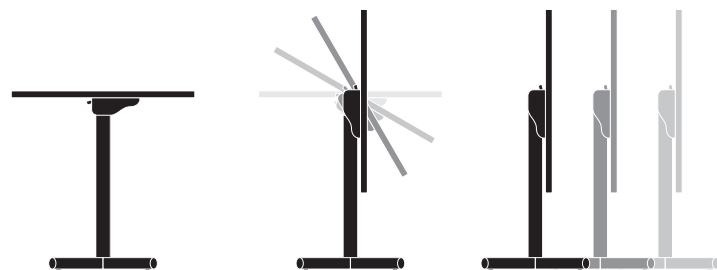



## Folding T-bases and TT-bases

Rectangular, racetrack, and some round tables fold for easy storage. These tables are noted in the pricer by an "FD" at the end of the model number.

### Standard Folding

Racetrack and rectangular tables 60" and longer use two standard folding mechanisms. Bases fold toward each other and end up toe-to-toe for a total thickness of 4.75" per table.

### Short Folding

All round tables and any rectangular tables 48" long or less use a short fold mechanism. Bases fold one over the other for a total thickness of 6.75" per table.

### Storage Table Carts

Carts to help store and move tables are available. See pricing below.

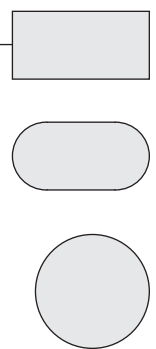
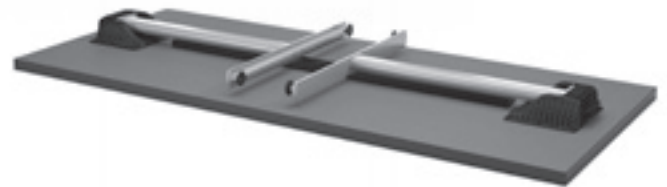

	00 - Ultra	01 - Foundation	02 - Fundamental	06 - Stretch	08 - Elite	33 - Element	44 - Primary	45 - Puddle	71 - Exclaim	74 - VerfiGo	88 - Next	99 - Surge
<b>Folding Option</b>												
folding T	•	•	•	•	•							•
folding TT	•	•	•	•	•							

standard folding

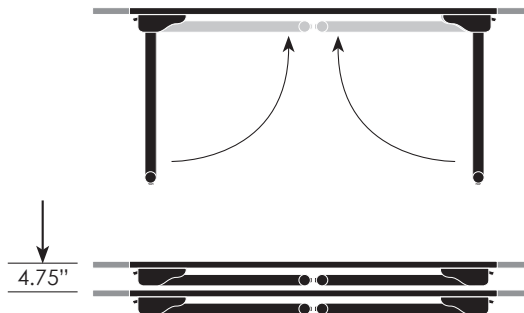

short folding

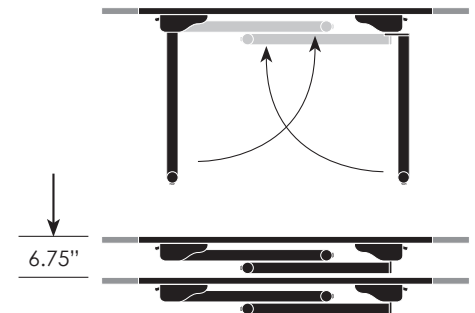

## Folding Table Carts

Table Shape	Max Table	Capacity	Model Number	Finish	Price	Mobile Carts
Round	60"	Four short-fold tables	STC-RD60	01 Structured Black	\$ 1,180	
Rectangle	30 x 60"	Six folding tables	STC-TC60	01 Structured Black	1,307	
	30 x 72"	Six folding tables	STC-TC72	01 Structured Black	1,307	
	30 x 84"	Six folding tables	STC-TC84	01 Structured Black	1,391	
	30 x 96"	Six folding tables	STC-TC96	01 Structured Black	1,391	

## RC Radius Corners

3" radius corners soften the corner of tables to give them a smooth feel. Upcharge is \$55.



## LT Lightweight Tops

Great for use on folding tables, these tops are 40% lighter than our standard tops. Constructed of a bass-wood core with Luan faces. Available only on tables with a standard 3mm PVC edge. Upcharge is \$115.



## GR Grommets

Grommets can be added to most table shapes for an upcharge of \$40 each. Simply add "-GR" to your model number. 60 mm radius hole. Available in black. See page 150 for location details.



## Markerboard Laminates

White markerboard laminate, Pionite SW844 High Gloss Bright White can be specified on any table for an upcharge of \$100 per table. We suggest pairing this with a dark 3mm edge. There are other markerboard laminates available from Formica & Pionite. Call customer service for custom quotes on those laminates.



**new**

## CM Cable Manager

Cable managers can be added to most table shapes for an upcharge of \$50 each. Available in black. See page 150 for location details.



## Modesty & Privacy Panels

Modesty & privacy panels can be added to many table sizes, and some can also be used on folding and nesting models.

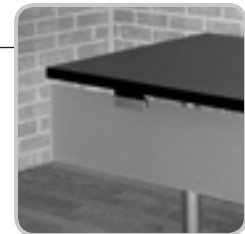

Available in laminate, metal, frosted acrylic, and mesh. See pages 190-193 for complete selection and pricing.

## Solid Surface Tops

Need something a little more substantial? We can offer solid surface tops on many of our tables. These are quite popular on disc and X-based cafe tables. Call customer surface for a custom quote. Leadtime on solid surface is usually around 5-6 weeks.

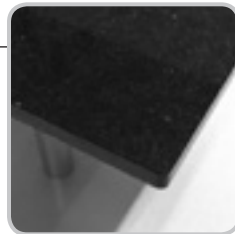

## PHK Purse Hooks

Accessory hooks are great for hanging coats and purses. This is a simple add on item that works on practically any table. \$10 list each.



**new**

## GN Ganging

Ganging brackets can be added to most tables for a \$40 upcharge. Note that some top shapes are already priced with ganging brackets included. Two plates and 8 knobs are shipped per table.

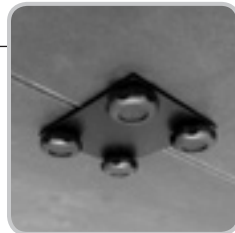

## Custom Logo Tops

Make your laminate table top the focal point of any room by adding your logo in full color. Working with Wilsonart, we can add logos that utilize standard laminates into the background and integrate them into the logos themselves.



**new**

Tables are drilled to gang side-to-side. If face-to-face or another custom configuration is needed please supply a drawing with your purchase order.

This process requires a custom quote, and does require an extended leadtime, but the final results are worth it.

## LC Locking Casters

2" locking casters can be added to most tables for an upcharge of \$90. Check product details for availability.

Note: nesting tables are priced with locking casters included.



## WM Built In Wire Manager

One of two bases will have a 1x19" steel access door with self closing hinges. Door height can vary depending on other specified options. Check series details for availability. Upcharge is \$125. See page 202 for details.



## CCG Concealed Casters

Concealed casters can be specified on one side of a T-based table. Other side will have standard glides. Overall height remains at 29". Upcharge is \$120.

Only available on Foundation, Fundamental, & Element series. (Foundation uses black end cap as pictured.)



## WMLC Snap-on Wire Management Leg Cover

Snaps on to round columns and offers coverage of wires down the leg. Powdercoated steel to match base color. Check series details for compatibility. Upcharge is \$45. See page 202 for details.



## OS Offset T-bases

Most T-bases can be upgraded to offset T-bases. The standard offset is 3". Check product details for availability. Upcharges vary based on series.

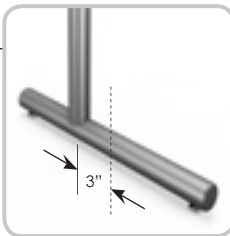

## MMLC Magnetic Wire Management Leg Cover

Magnetically attaches to rectangular and square columns and offers coverage of wires down the leg. Powdercoated steel to match base color. Check series details for compatibility. Upcharge is \$55. See page 202 for details.



new

## CH Chrome Finish

Chrome finish is a premium finish available on select models. Check product details for availability. Upcharges vary based on series and number of bases.



## PB Powerbox Mounting Plate

The powerbox is ideal for round and square tables that have a power unit centered in the top. This U-shaped mounting plate allows 2.75x8x12" for the unit itself, and wire management through the column. Available on most X-bases and disc bases for \$125 upcharge.



new

## EM Edge Mounted T-bases

T-Bases and TT-Bases can be specified as edge mounted bases on most static models for \$50. Bases on tables 36-48" in length are already edge mounted.

The position of bases on folding and nesting tables cannot be adjusted.

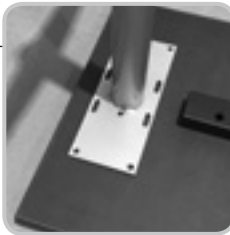

## Fully Customized Tables

Have a customer asking for something a bit outside the box? We pride ourselves in finding ways to solve problems that other manufacturers walk away from. Call customer service and let us know what you need, and how we can help create a table just for you.



table length	EM
36-48"	standard
60-96"	\$50

## SH Special Height

Special height tables can be specified in most series. Standard height is 29". Upcharges vary based on base and height needed.

Tables larger than 36x72" will need a stretcher bar between the bases. Contact customer service to quote these tables.

When specifying, include your custom height in the model number. For example: (-SH.42) for special height of 42".

base	< 29"	> 29"
X-base	+ 30	+ 65
disc base	+ 30	+ 65
two T-bases	+ 65	+ 130
two TT-bases	+ 130	+ 260
four columns	+ 130	+ 260
X.4 base	+ 130	+ 260

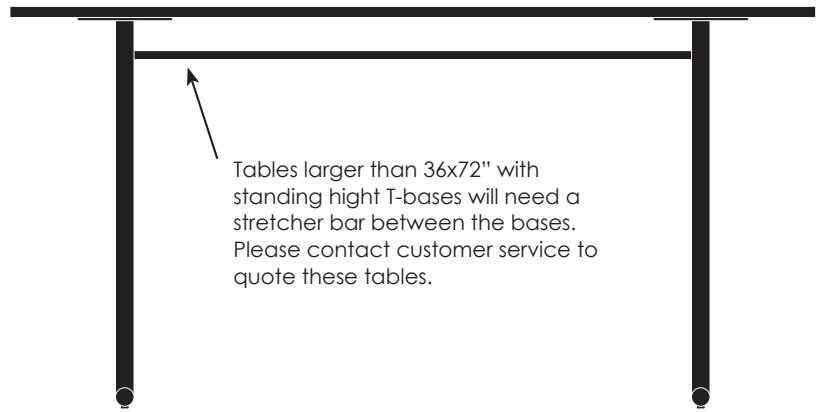
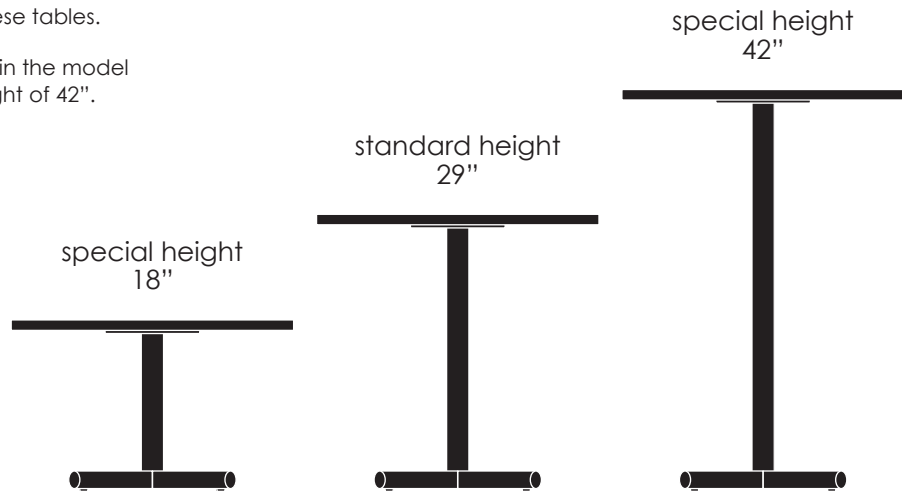

Tables larger than 36x72" with standing high T-bases will need a stretcher bar between the bases. Please contact customer service to quote these tables.

## FR Footring

A footring is available on disc bases and select X-bases that are at standing height. Check product details for availability. Upcharge is \$150. Not available in chrome.





## EH Electric

Electric height adjustability gives you the height range as the counter balanced, but is available in a wider variety of top shapes and sizes. The memory keypad remembers your four favorite heights. Available in both VertiGo & Surge.



	00 - Ultra	01 - Foundation	02 - Fundamental	06 - Stretch	08 - Elite	33 - Element	44 - Primary	45 - Puddle	71 - Exclaim	74 - VertiGo	88 - Next	99 - Surge
<b>Height Adjustable Options</b>												
spring clip		●	●	●	●		●					●
ratchet		●	●							●		
counter bal.		●	●				●			●		●
short bal.		●	●				●			●		●
pneumatic		●	●				●	●			●	
hand crank										●		
electric										●		●

## BL Counter balanced

Need to get the most out of your height adjustable tables? The counter balanced option is the way to go. Simply squeeze the small handle underneath and gently move the top to your desired height. With a range over 17" and infinite choices in between, it's just that easy.

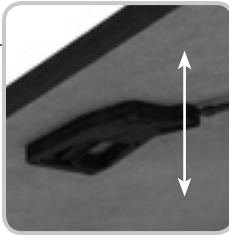

## BLS Short Balanced

Go from coffee table height to standard height with the Short Balanced. Simply squeeze the small handle underneath and gently move the top to your desired height. Approximately 18-29".

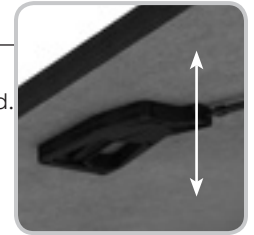

**new**

## CR Hand Crank

Need the flexibility of infinite adjustability without the budget for counter balanced bases? Our manual hand crank offers a cost-effective alternative. Only available in the VertiGo series, but is available on some nesting models.



## NU Pneumatic

Most square (max 36") and round (max 42") tables are available with pneumatic height adjustability. 12" range in 1" increments. Upcharge is \$350 on X and disc bases. Also available on select T-bases in Foundation & Fundamental for \$700, including some nesting models.

	base	NU
X-base		\$350
T-base		\$700

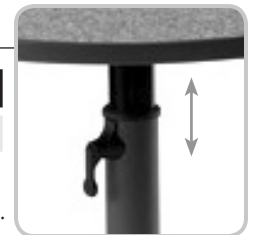

## RA Ratchet

Ratchet height adjustability is available on select VertiGo, Foundation, & Fundamental tables. With a range of 9.45" the ratchet works in thirteen increments of .78". To reset to the lowest position, just lift past its highest point. Ratchet height adjustable bases are also available on some nesting tables.

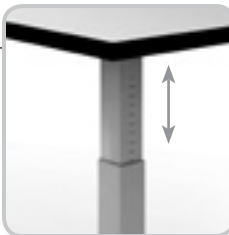

## AH Spring Clip

A spring clip height adjustment mechanism is available on most tubular bases. See each series for availability. Height adjustment range is 26-32".

	base	AH
X-base		\$125
T-base		\$250
columns		\$500

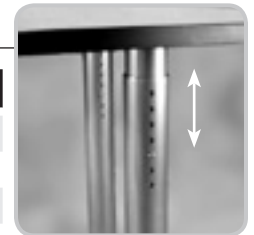





Not available on tables larger than 42" round or 36" square.

## General Guidelines





- Allow about 30" /person
- Allow 48" for aisles between tables. ADA has 36" min.
- Allow 96"-120" between presenter and front row.
- Rooms with only one entrance are restricted to accommodate a maximum of 50 people (per fire code).
- Space required for single wheelchair passage is 36" min.
- Space required for double wheelchair passage is 60" min.
- Space required to turn a wheelchair is 60" dia.
- ADA Minimum table depth of 24".
- Newer wheelchair arms are designed to fit under NOTE: 45 and 60 degree standard 29"h tables (older models require an extra 2.5" of clearance)
- Ganging Wedges are not recommended for seating if top is not supported by a base.
- Capacities are based upon a 30" minimum width per seat. This chart is only a guideline which can vary based upon seating design and table layout.







rectangle		boat-shaped		racetrack		elliptical					
18 x 30	1	30 x 36	2	48 x 60	6	30 x 42 x 84	6 - 8	36 x 60	4	30 x 54	4
18 x 36	1	30 x 48	2 - 4	48 x 72	6 - 8	30 x 42 x 90	8	36 x 72	4	30 x 60	4
18 x 48	1	30 x 60	4	48 x 84	6 - 8	30 x 42 x 96	8 - 10	36 x 84	6	36 x 60	4
18 x 60	2	30 x 72	6	48 x 90	8	36 x 48 x 84	6 - 8	36 x 90	8	36 x 72	4
18 x 72	3	30 x 84	6	48 x 96	8 - 10	36 x 48 x 90	8	36 x 96	6 - 8	36 x 84	6
18 x 84	4	30 x 90	6	48 x 120	10 - 12	36 x 48 x 96	8 - 10	42 x 84	6 - 8	36 x 90	8
18 x 90	4	30 x 96	8	48 x 144	12	36 x 48 x 120	10 - 12	42 x 90	8	36 x 96	6 - 8
18 x 96	4 - 5	36 x 48	2 - 4	54 x 60	6	36 x 48 x 144	12	42 x 96	8 - 10	42 x 72	6
20 x 36	2	36 x 60	4 - 6	54 x 72	8	48 x 54 x 120	10 - 12	42 x 120	10 - 12	42 x 84	6 - 8
20 x 48	2	36 x 72	6 - 8	54 x 84	8	48 x 54 x 144	12	42 x 144	12	42 x 90	8
20 x 60	2 - 3	36 x 84	6 - 8	54 x 90	8	54 x 60 x 120	10 - 12	48 x 84	6 - 8	42 x 96	8 - 10
20 x 72	3	36 x 90	8	54 x 96	8 - 10	54 x 60 x 144	12	48 x 90	8	42 x 120	10 - 12
20 x 84	4	36 x 96	8 - 10	54 x 120	10 - 12			48 x 96	8 - 10	42 x 144	12
20 x 90	4	42 x 60	6 - 8	54 x 144	12			48 x 120	10 - 12	48 x 72	6
20 x 96	4 - 5	42 x 72	6 - 8	60 x 72	8			48 x 144	12	48 x 84	6 - 8
24 x 36	1	42 x 84	6 - 8	60 x 84	8			54 x 120	10 - 12	48 x 90	8
24 x 48	1	42 x 90	8	60 x 90	8			54 x 144	12	48 x 96	8 - 10
24 x 60	2	42 x 96	8 - 10	60 x 96	8 - 10			60 x 120	10 - 12	48 x 120	10 - 12
24 x 72	3	42 x 120	10 - 12	60 x 120	10 - 12			60 x 144	12	48 x 144	12
24 x 84	4	42 x 144	12	60 x 144	12						
24 x 90	4										
24 x 96	4 - 5										

				 <i>new</i>							
square		round		squirle		half round		D-shaped			
24 x 24	2	24 x 24	2	24 x 24	2	18 x 36	1 - 2	24 x 36	1	42 x 60	5 - 7
30 x 30	2	30 x 30	2	30 x 30	2	24 x 48	2	24 x 48	1	42 x 72	5 - 7
36 x 36	4	36 x 36	3	36 x 36	4	30 x 60	3	24 x 60	2	42 x 84	5 - 7
42 x 42	4	42 x 42	4	42 x 42	4	36 x 72	4	24 x 72	3	42 x 90	7
48 x 48	4	48 x 48	4 - 5	48 x 48	4			24 x 84	3	42 x 96	7 - 9
54 x 54	4 - 8	54 x 54	5					24 x 90	3	48 x 60	5 - 7
60 x 60	4 - 8	60 x 60	6 - 7					24 x 96	2 - 3	48 x 72	5 - 7
								30 x 48	2 - 3	48 x 84	5 - 7
								30 x 60	3	48 x 90	7
								30 x 72	5	48 x 96	7 - 9
								30 x 84	5	54 x 54	4
								30 x 90	5	54 x 60	6
								30 x 96	7	54 x 72	8
								36 x 48	2 - 3	54 x 84	8
								36 x 60	3 - 5	54 x 90	8
								36 x 72	5 - 7	54 x 96	8 - 10
								36 x 84	5 - 7	54 x 120	10 - 12
								36 x 90	7	54 x 144	12
								36 x 96	7 - 9	60 x 60	6
										60 x 72	8
										60 x 84	8
										60 x 90	8
										60 x 96	8 - 10
										60 x 120	10 - 12
										60 x 144	12







  

							
crescent		trapezoid		corner		arc segment	
24 x 48 x 75	2	24 x 48	4 - 5	24 x 42	1	20 x 44	2
24 x 60 x 94	2	24 x 72	4 - 5	30 x 48	1	24 x 51	2
30 x 60 x 94	4	30 x 60	4 - 5			30 x 59	2
		36 x 72	4 - 5			36 x 67	2

							
quarter round		ganging wedge		video wedge		transition	
20 x 20	0	20 x 20	0	20 x 20 x 40	2	20 x 30	0
24 x 24	1	24 x 24	0	24 x 24 x 48	2	24 x 30	1
30 x 30	1	30 x 30	1	30 x 30 x 60	2	30 x 30	1
36 x 36	1	36 x 36	1	36 x 36 x 72	2	36 x 30	1

											
trident		quadrant		bulb		teardrop		table desk		kidney bean	
36 x 36 x 18	3	60 x 60 x 18	4	24 x 24 x 18	2	24 x 48	4	37 x 60	1	18 x 30	1
40 x 40 x 20	3	60 x 60 x 20	4	30 x 30 x 20	2			42 x 78	1	18 x 36	1
48 x 48 x 24	3	60 x 60 x 24	4	36 x 36 x 24	2					20 x 30	1
60 x 60 x 30	3	60 x 60 x 30	4	42 x 42 x 30	3					20 x 36	1
				48 x 48 x 36	3						



Ultra

**new**



Two rigid rectangular frame bases make a solid statement in our Ultra series. These sturdy tables look the part in both the private office and in training applications.

**Ultra Base Styles**



U

**Ultra Base Options**



standard glides

locking casters

- LC Locking Casters**  
can be added to any table for \$90.
- FD Folding Bases**  
are not available on Ultra tables.
- NE Nesting Tables**  
are not available in the Ultra series.
- FT Flip Tops**  
are not available on Ultra tables.
- OS Offset Bases**  
are not available on Ultra tables.
- CH Chrome Finish**  
is not available on Ultra tables.
- WM Wire Management**  
Built in wire management is not available on Ultra tables.
- MMLC Magnet Wire Management Leg Covers**  
Magnetically snap onto any square leg and are \$55 each.
- SH Special Height**  
of can be added to any table:  
+ \$130 per base for heights > 29"  
+ \$70 per base for heights < 29"  
Special height tables larger than 36x72" must be custom quoted.



## Ultra Top Shapes



rectangle  
p.28-29



boat  
p.29



round  
p.29



racetrack  
p.30



D-shaped  
p.31



table desk  
p.31

## Ultra Top Options

**RC** **3" Radius Corners**  
are not available on  
Ultra tables.

**GN** **Ganging Brackets**  
are not available on  
Ultra tables.







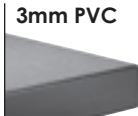
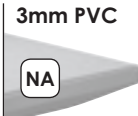

**LT** **Lightweight Tops**  
can be added to any  
table for \$115.

**GR** **Grommets**  
can be added to any  
table for \$40 each. To  
see specific locations,  
see page 203.

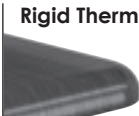
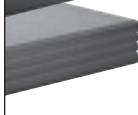
**CM** **Cable Manager**  
can be added to any  
table for \$50 each. To  
see specific locations,  
see page 203.

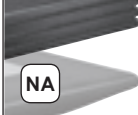
## Ultra Edge Options

(correspond with 5 columns of pricing)

3mm PVC	3mm PVC	3mm Wood	1.25" Wood	Rigid Thermofoil
 <p><b>3P</b> Flat</p>	 <p><b>3K</b> Knife</p>	 <p><b>3W</b> Flat</p>	 <p><b>W1</b> Bullnose</p>	 <p><b>F1</b> Waterfall</p>
 <p><b>3P</b> Reed</p>	<p><b>NA</b></p>	<p><b>NA</b></p>	 <p><b>W2</b> Square</p>	 <p><b>F2</b> Flat</p>
			 <p><b>W3</b> Fluted</p>	 <p><b>F3</b> Bevel</p>
			 <p><b>W4</b> Reverse Bevel</p>	 <p><b>F4</b> Radius</p>
				 <p><b>F5</b> Slope</p>

new

Rectangular with U-bases





Ultra

Top Size	Base	Model Number	3P	3K	3W	W1-W3	F1-F5
20 x 36	Static	00TC2036U18	\$ 661	\$ NA	\$ 805	\$ 931	\$ 701
20 x 48	Static	00TC2048U18	707	NA	883	1,035	719
20 x 60	Static	00TC2060U18	797	NA	1,002	1,203	878
20 x 72	Static	00TC2072U18	836	NA	1,074	1,307	916
20 x 84	Static	00TC2084U18	913	NA	1,186	1,411	1,038
20 x 90	Static	00TC2090U18	959	NA	1,250	1,461	1,038
20 x 96	Static	00TC2096U18	959	NA	1,264	1,511	1,059
24 x 36	Static	00TC2436U22	681	NA	833	993	783
24 x 48	Static	00TC2448U22	726	NA	911	1,101	800
24 x 60	Static	00TC2460U22	816	NA	1,031	1,280	936
24 x 72	Static	00TC2472U22	855	NA	1,102	1,388	969
24 x 84	Static	00TC2484U22	932	NA	1,214	1,500	1,133
24 x 90	Static	00TC2490U22	978	NA	1,279	1,553	1,144
24 x 96	Static	00TC2496U22	978	NA	1,292	1,607	1,155
30 x 36	Static	00TC3036U28	734	NA	904	1,074	847
30 x 48	Static	00TC3048U28	791	NA	994	1,197	857
30 x 60	Static	00TC3060U28	876	NA	1,109	1,384	1,089
30 x 72	Static	00TC3072U28	921	NA	1,186	1,503	1,164
30 x 84	Static	00TC3084U28	1,029	NA	1,333	1,623	1,175
30 x 90	Static	00TC3090U28	1,086	NA	1,409	1,684	1,196
30 x 96	Static	00TC3096U28	1,086	NA	1,423	1,742	1,206
36 x 48	Static	00TC3648U34	855	NA	1,076	1,289	927
36 x 60	Static	00TC3660U34	991	NA	1,247	1,488	1,206
36 x 72	Static	00TC3672U34	1,033	NA	1,322	1,619	1,326
36 x 84	Static	00TC3684U34	1,126	NA	1,452	1,750	1,348
36 x 90	Static	00TC3690U34	1,193	NA	1,539	1,815	1,358
36 x 96	Static	00TC3696U34	1,193	NA	1,553	1,881	1,363
42 x 60	Static	00TC4260U40	1,069	NA	1,345	1,588	1,215
42 x 72	Static	00TC4272U40	1,150	NA	1,462	1,730	1,347
42 x 84	Static	00TC4284U40	1,227	NA	1,574	1,873	1,368
42 x 90	Static	00TC4290U40	1,302	NA	1,671	1,942	1,389
42 x 96	Static	00TC4296U40	1,302	NA	1,685	2,015	1,399
48 x 60	Static	00TC4860U46	1,146	NA	1,441	1,692	1,347
48 x 72	Static	00TC4872U46	1,238	NA	1,571	1,846	1,478
48 x 84	Static	00TC4884U46	1,246	NA	1,608	1,996	1,499
48 x 90	Static	00TC4890U46	1,323	NA	1,705	2,073	1,542
48 x 96	Static	00TC4896U46	1,323	NA	1,719	2,150	1,552

tables larger than 36x72": **SH** quote

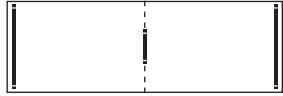

online updates  
new product  
clarification / edit  
deletion

- LC**  
+90
- OS**  
NA
- CH**  
NA
- WM**  
NA
- MMLC**  
+55
- SH**  
+260
- FR**  
NA
- PB**  
NA
- GR**  
+40
- CM**  
+50
- RC**  
NA
- GN**  
NA
- LT**  
+115

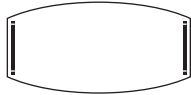

Top Size	Base	Model Number	3P	3K	3W	W1-W3	F1-F5	Rectangular with 3 U-bases	NEW
42 x 120	Static	00TC42120U40U18	\$2,047	\$ NA	\$2,516	\$2,731	\$2,521	 	
42 x 144	Static	00TC42144U40U18	2,202	NA	2,742	3,012	2,542		
48 x 120	Static	00TC48120U46U18	2,076	NA	2,559	2,889	2,594		
48 x 144	Static	00TC48144U46U18	2,233	NA	2,787	3,189	2,647		

3 bases: **LC** **SH**  
+135 quote

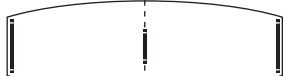

Ultra

Top Size	Base	Model Number	3P	3K	3W	W1-W3	F1-F5	Boat-Shaped with U-bases	NEW
30 x 42 x 84	Static	00BT3084U28	\$1,390	\$ NA	\$1,715	\$2,435	\$1,240	 	
30 x 42 x 90	Static	00BT3090U28	1,498	NA	1,848	2,535	1,487		
30 x 42 x 96	Static	00BT3096U28	1,498	NA	1,862	2,631	1,500		
36 x 48 x 84	Static	00BT3684U34	1,516	NA	1,861	2,596	1,495		
36 x 48 x 90	Static	00BT3690U34	1,640	NA	2,010	2,700	1,547		
36 x 48 x 96	Static	00BT3696U34	1,640	NA	2,024	2,800	1,560		

3 bases: **LC** **SH**  
+135 quote

Top Size	Base	Model Number	3P	3K	3W	W1-W3	F1-F5	Boat-Shaped with 3 U-bases	NEW
36 x 48 x 120	Static	00BT36120U34U18	\$2,475	\$ NA	\$2,955	\$3,643	\$2,554	 	
36 x 48 x 144	Static	00BT36144U34U18	2,721	NA	3,281	4,055	2,607		

4 bases: **LC** **SH**  
+180 quote

Top Size	Base	Model Number	3P	3K	3W	W1-W3	F1-F5	Round with 4 U-bases	NEW
48 x 48	Static	00RD48U18(4)	\$1,377	\$ NA	\$1,591	\$2,374	\$1,404	 	
54 x 54	Static	00RD54U18(4)	1,537	NA	1,788	2,636	NA		
60 x 60	Static	00RD60U18(4)	1,559	NA	1,834	2,913	NA		

online updates  
new product  
clarification / edit  
deletion

- LC**  
+90
- OS**  
NA
- CH**  
NA
- WM**  
NA
- MMLC**  
+55
- SH**  
+260
- FR**  
NA
- PB**  
NA
- GR**  
+40
- CM**  
+50
- RC**  
NA
- GN**  
NA
- LT**  
+115

new

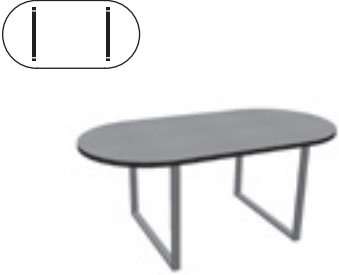
Racetrack with U-bases	Top Size	Base	Model Number	3P	3K	3W	W1-W3	F1-F5
	36 x 72	Static	OORT3672U34	\$ 1,141	\$ NA	\$ 1,411	\$ 2,063	\$ 1,385
	36 x 84	Static	OORT3684U34	1,304	NA	1,611	2,315	1,482
	36 x 90	Static	OORT3690U34	1,426	NA	1,759	2,408	1,495
	36 x 96	Static	OORT3696U34	1,426	NA	1,773	2,496	1,501
	42 x 84	Static	OORT4284U40	1,426	NA	1,751	2,473	1,502
	42 x 90	Static	OORT4290U40	1,537	NA	1,887	2,573	1,528
	42 x 96	Static	OORT4296U40	1,537	NA	1,901	2,669	1,540
	48 x 84	Static	OORT4884U46	1,678	NA	2,035	2,635	1,535
	48 x 90	Static	OORT4890U46	1,678	NA	2,049	2,739	1,586
	48 x 96	Static	OORT4896U46	1,678	NA	2,062	2,839	1,599

new

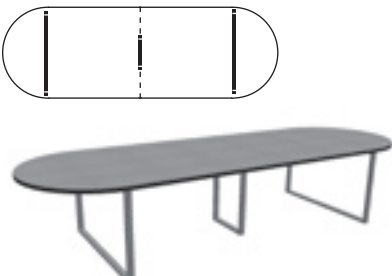
Racetrack with 3 U-bases	Top Size	Base	Model Number	3P	3K	3W	W1-W3	F1-F5
	42 x 120	Static	OORT42120U40U18	\$ 2,481	\$ NA	\$ 2,951	\$ 3,489	\$ 2,521
	42 x 144	Static	OORT42144U40U18	2,725	NA	3,275	3,878	2,542
	48 x 120	Static	OORT48120U46U18	2,514	NA	2,994	3,682	2,594
	48 x 144	Static	OORT48144U46U18	2,760	NA	3,320	4,094	2,647

3 bases: **LC** **SH**  
+135 quote

**LC**  
+90

**OS**  
NA

**CH**  
NA

**WM**  
NA

**MMLC**  
+55

**SH**  
+260

**FR**  
NA

**PB**  
NA

**GR**  
+40

**CM**  
+50

**RC**  
NA

**GN**  
NA

**LT**  
+115

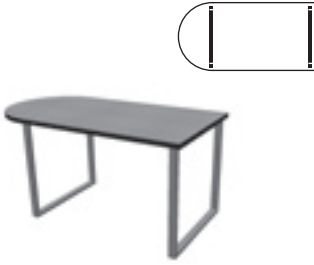
Top Size	Base	Model Number	3P	3K	3W	W1-W3	F1-F5	D-shaped with U-bases
24 x 36	Static	00D2436U22	\$ 726	\$ NA	\$ 872	\$ 1,162	\$ 782	
24 x 48	Static	00D2448U22	789	NA	968	1,297	854	
24 x 60	Static	00D2460U22	851	NA	1,064	1,431	927	
24 x 72	Static	00D2472U22	982	NA	1,229	1,634	1,072	
24 x 84	Static	00D2484U22	1,044	NA	1,325	1,769	1,145	
24 x 90	Static	00D2490U22	1,076	NA	1,374	1,838	1,181	
24 x 96	Static	00D2496U22	1,107	NA	1,422	1,907	1,218	
30 x 48	Static	00D3048U28	870	NA	1,067	1,412	948	
30 x 60	Static	00D3060U28	949	NA	1,181	1,558	1,017	
30 x 72	Static	00D3072U28	1,095	NA	1,362	1,773	1,201	
30 x 84	Static	00D3084U28	1,173	NA	1,476	1,919	1,293	
30 x 90	Static	00D3090U28	1,212	NA	1,533	1,992	1,338	
30 x 96	Static	00D3096U28	1,251	NA	1,590	2,065	1,384	
36 x 48	Static	00D3648U34	952	NA	1,166	1,528	1,041	
36 x 60	Static	00D3660U34	1,046	NA	1,297	1,685	1,150	
36 x 72	Static	00D3672U34	1,208	NA	1,495	1,907	1,326	
36 x 84	Static	00D3684U34	1,301	NA	1,626	2,065	1,347	
36 x 90	Static	00D3690U34	1,348	NA	1,692	2,146	1,501	
36 x 96	Static	00D3696U34	1,395	NA	1,757	2,223	1,512	
42 x 72	Static	00D4272U40	1,321	NA	1,629	2,046	1,347	
42 x 84	Static	00D4284U40	1,531	NA	1,887	2,211	1,368	
42 x 90	Static	00D4290U40	1,593	NA	1,969	2,296	1,389	
42 x 96	Static	00D4296U40	1,654	NA	2,051	2,381	1,532	
48 x 72	Static	00D4872U46	1,434	NA	1,762	2,181	1,478	
48 x 84	Static	00D4884U46	1,559	NA	1,927	2,362	1,499	
48 x 90	Static	00D4890U46	1,621	NA	2,010	2,539	1,542	
48 x 96	Static	00D4896U46	1,684	NA	2,092	2,539	1,552	

Ultra

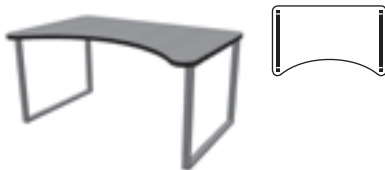
Top Size	Base	Model Number	3P	3K	3W	W1-W3	F1-F5	Table Desk with U-bases
37 x 60	Static	00TA3760U34	\$ 1,108	\$ NA	\$ 1,401	\$ 2,092	\$ 1,237	
42 x 78	Static	00TA4278U40	1,382	NA	1,759	2,535	1,588	

**LC**  
+90

**OS**  
NA

**CH**  
NA

**WM**  
NA

**MMLC**  
+55

**SH**  
+260

**FR**  
NA

**PB**  
NA

**GR**  
+40

**CM**  
+50

**RC**  
NA

**GN**  
NA

**LT**  
+115



Any traditional table function can be accommodated with competitively priced and cleanly styled Foundation tables. This series is great for schools and stands the test of time.

### Foundation Base Styles



### Foundation Base Options



- LC Locking Casters**  
can be added to any table for \$90.
- CCG Concealed Casters**  
available on one T-base for \$120 per table. Standard glides on opposite base.
- BN Bullnose End**  
available on all Foundation bases for \$65 per table.
- FD Folding Bases**  
priced accordingly with standard glides.
- NE Nesting Tables**  
priced accordingly with locking casters.

- FT Flip Tops**  
available on X-based tables and are priced with standard glides.
- OS Offset Bases**  
available for \$35.
- CH Chrome Finish**  
available for \$100 on most models. Upcharge for disc bases is \$400.
- WM Wire Management**  
Built in wire management is available on one leg for \$125.
- WMLC Wire Management Leg Covers**  
snap onto any leg and are \$45 each.

- SH Special Height**  
of can be added to any table:  
+ \$65 per column for heights > 29"  
+ \$35 per column for heights < 29"  
Special height tables larger than 36x72" must be custom quoted.
- FR Footring**  
available on standing height disc-bases for \$150. Not available in chrome.
- PB Power Box Mounting Plate**  
is available on disc & X-bases for \$90.

## Foundation Height Adjustable Options

- NU Pneumatic** is available on X-bases for \$350 and on T-bases for \$700 per table.
- AH Spring Clip** is available on X-bases for \$125 and on T-bases for \$250 per table.
- RA Ratchet** is available on T-bases & nesting for \$365 per table and are available in three finishes:
  - 02 Black
  - 30 Pearl
  - 37 Satin Silver
- BL Counterbalanced and short balanced** are available on disc bases and are available in three finishes:
  - 02 Black
  - 30 Pearl
  - 37 Satin Silver

## Foundation Top Shapes

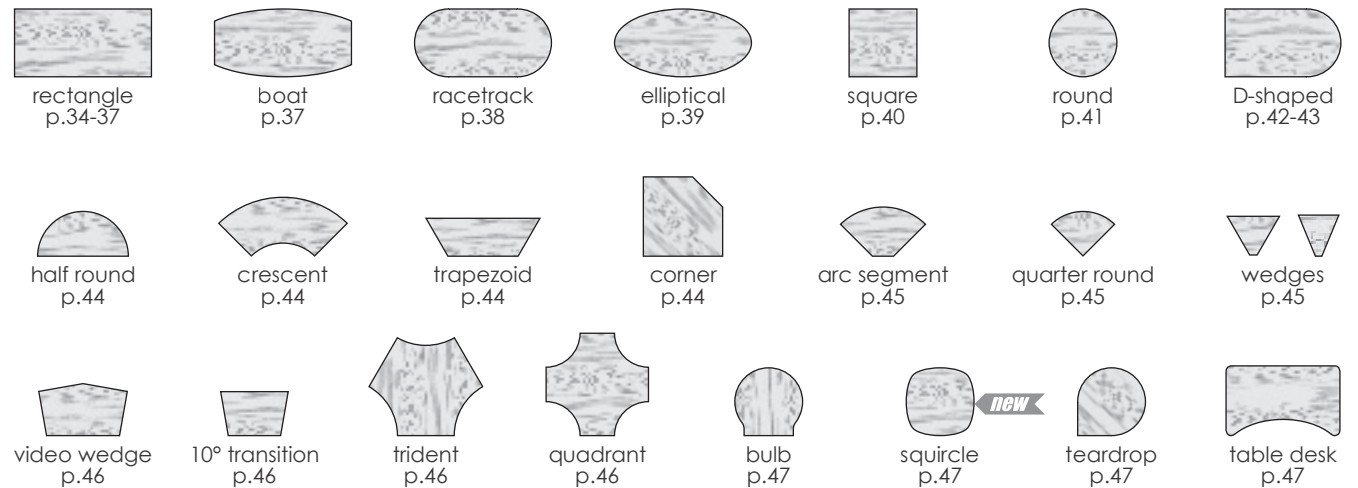

Foundation



## Foundation Top Options

- RC 3" Radius Corners** can be added to any table for \$55.
- GN Ganging Brackets** can be added to most table shapes for \$40.
- LT Lightweight Tops** can be added to any square or rectangular table for \$115. This is a great option when specifying folding tables.
- GR Grommets** can be added to any table for \$40 each. To see specific locations, see page 203.
- CM Cable Manager** can be added to any table for \$50 each. To see specific locations, see page 203.

## Foundation Edge Options

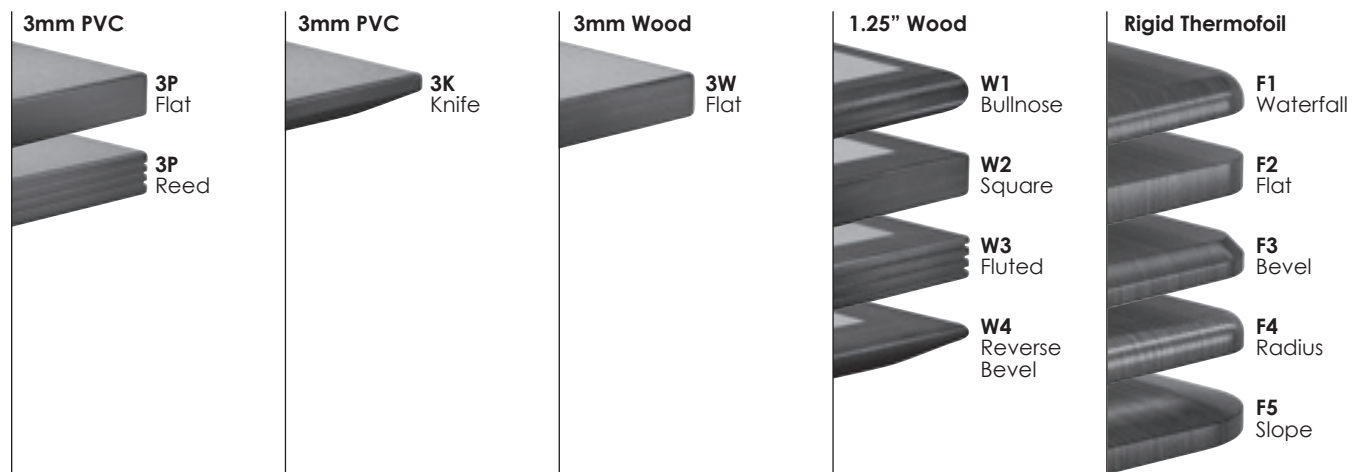
(correspond with 5 columns of pricing)





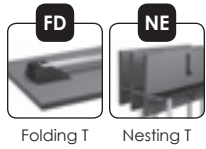

Rectangular with T-bases	Top Size	Base	Model Number	3P	3K	3W	W1-W4	F1-F5
 	18 x 36	Static	01TC1836T16	\$ 515	\$ 558	\$ 650	\$ 800	\$ 564
		Nesting	01TC1836T18NE	941	983	1,074	NA	1,030
		18 x 48	Static	01TC1848T16	550	607	717	896
	Folding		01TC1848T16FD	803	860	970	1,149	855
	Nesting		01TC1848T18NE	1,002	1,058	1,166	NA	1,084
	18 x 60	Static	01TC1860T16	585	656	783	996	655
		Folding	01TC1860T16FD	848	920	1,046	1,259	932
		Nesting	01TC1860T18NE	1,093	1,163	1,287	NA	1,207
	18 x 72	Static	01TC1872T16	620	705	849	1,096	747
		Folding	01TC1872T16FD	883	968	1,112	1,359	1,024
		Nesting	01TC1872T18NE	1,305	1,388	1,529	NA	1,509
	18 x 84	Static	01TC1884T16	723	822	983	1,264	841
Folding		01TC1884T16FD	918	1,017	1,179	1,459	1,047	
Nesting		01TC1884T18NE	1,339	1,436	1,594	NA	1,531	
18 x 90	Static	01TC1890T16	758	871	1,035	1,314	841	
	Folding	01TC1890T16FD	953	1,066	1,231	1,509	1,047	
	Nesting	01TC1890T18NE	1,373	1,484	1,646	NA	1,531	
18 x 96	Static	01TC1896T16	758	871	1,049	1,360	852	
	Folding	01TC1896T16FD	953	1,066	1,245	1,556	1,057	
	Nesting	01TC1896T18NE	1,373	1,484	1,659	NA	1,542	
20 x 36	Static	01TC2036T18	549	606	692	819	584	
	Nesting	01TC2036T20NE	974	1,030	1,115	NA	1,049	
20 x 48	Static	01TC2048T18	595	670	771	923	601	
	Folding	01TC2048T18FD	848	923	1,024	1,176	867	
	Nesting	01TC2048T20NE	1,046	1,120	1,219	NA	1,095	
20 x 60	Static	01TC2060T18	616	700	822	1,023	688	
	Folding	01TC2060T18FD	880	963	1,085	1,286	965	
	Nesting	01TC2060T20NE	1,123	1,205	1,325	NA	1,240	
20 x 72	Static	01TC2072T18	656	755	893	1,127	726	
	Folding	01TC2072T18FD	919	1,019	1,156	1,390	1,003	
	Nesting	01TC2072T20NE	1,340	1,438	1,573	NA	1,488	
20 x 84	Static	01TC2084T18	801	931	1,073	1,299	920	
	Folding	01TC2084T18FD	996	1,126	1,269	1,494	1,125	
	Nesting	01TC2084T20NE	1,415	1,543	1,683	NA	1,608	
20 x 90	Static	01TC2090T18	847	995	1,138	1,349	920	
	Folding	01TC2090T18FD	1,042	1,191	1,333	1,544	1,125	
	Nesting	01TC2090T20NE	1,460	1,606	1,746	NA	1,608	
20 x 96	Static	01TC2096T18	847	995	1,152	1,399	941	
	Folding	01TC2096T18FD	1,042	1,191	1,347	1,594	1,146	
	Nesting	01TC2096T20NE	1,460	1,606	1,760	NA	1,629	



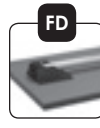

Foundation





Top Size	Base	Model Number	3P	3K	3W	W1-W4	F1-F5	Rectangular with T-bases
24 x 36	Static	01TC2436T20	\$ 552	\$ 608	\$ 704	\$ 864	\$ 647	    <p>Folding T    Nesting T</p>
	Nesting	01TC2436T22NE	977	1,033	1,127	NA	1,112	
24 x 48	Static	01TC2448T20	598	673	783	972	665	
	Folding	01TC2448T20FD	851	926	1,036	1,225	931	
24 x 60	Nesting	01TC2448T22NE	1,049	1,123	1,230	NA	1,158	
	Static	01TC2460T20	619	703	834	1,083	729	
	Folding	01TC2460T20FD	882	966	1,097	1,347	1,006	
24 x 72	Nesting	01TC2460T22NE	1,126	1,208	1,337	NA	1,279	
	Static	01TC2472T20	659	758	905	1,191	762	
	Folding	01TC2472T20FD	922	1,021	1,168	1,454	1,039	
24 x 84	Nesting	01TC2472T22NE	1,343	1,440	1,585	NA	1,524	
	Static	01TC2484T20	804	934	1,085	1,371	998	
	Folding	01TC2484T20FD	999	1,129	1,281	1,566	1,203	
24 x 90	Nesting	01TC2484T22NE	1,418	1,546	1,695	NA	1,685	
	Static	01TC2490T20	849	998	1,150	1,425	1,009	
	Folding	01TC2490T20FD	1,045	1,193	1,345	1,620	1,214	
24 x 96	Nesting	01TC2490T22NE	1,463	1,609	1,758	NA	1,695	
	Static	01TC2496T20	849	998	1,164	1,478	1,019	
	Folding	01TC2496T20FD	1,045	1,193	1,359	1,674	1,224	
30 x 36	Nesting	01TC2496T22NE	1,463	1,609	1,771	NA	1,706	
	Static	01TC3036T26	589	659	759	928	694	
	Folding	01TC3036T26FD	899	992	1,102	1,305	971	
30 x 48	Nesting	01TC3036T26NE	1,013	1,082	1,180	NA	1,158	
	Static	01TC3048T26	645	738	849	1,052	705	
	Folding	01TC3048T26FD	899	992	1,102	1,305	971	
30 x 60	Nesting	01TC3048T26NE	1,096	1,187	1,295	NA	1,197	
	Static	01TC3060T26	663	763	896	1,171	865	
	Folding	01TC3060T26FD	927	1,027	1,159	1,434	1,141	
30 x 72	Nesting	01TC3060T26NE	1,169	1,268	1,398	NA	1,413	
	Static	01TC3072T26	708	826	973	1,290	940	
	Folding	01TC3072T26FD	971	1,089	1,236	1,554	1,217	
30 x 84	Nesting	01TC3072T26NE	1,391	1,506	1,651	NA	1,698	
	Static	01TC3084T26	884	1,045	1,188	1,477	1,022	
	Folding	01TC3084T26FD	1,079	1,241	1,383	1,673	1,227	
30 x 90	Nesting	01TC3084T26NE	1,497	1,655	1,795	NA	1,709	
	Static	01TC3090T26	941	1,125	1,264	1,539	1,043	
	Folding	01TC3090T26FD	1,136	1,320	1,459	1,734	1,249	
30 x 96	Nest/Lightwt	01TC3090T26NE-LT	1,666	NA	1,994	NA	NA	
	Static	01TC3096T26	941	1,125	1,278	1,597	1,054	
	Folding	01TC3096T26FD	1,136	1,320	1,473	1,792	1,259	
30 x 96	Nest/Lightwt	01TC3096T26NE-LT	1,666	NA	2,008	NA	NA	

Foundation

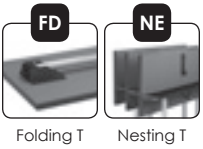
Rectangular with T-bases	Top Size	Base	Model Number	3P	3K	3W	W1-W4	F1-F5
 	36 x 48	Static	01TC3648T26	\$ 690	\$ 801	\$ 912	\$ 1,125	\$ 755
		Folding	01TC3648T26FD	943	1,054	1,165	1,378	1,020
		Nesting	01TC3648T26NE	1,299	1,408	1,517	NA	1,438
	36 x 60	Static	01TC3660T26	758	896	1,014	1,255	961
		Folding	01TC3660T26FD	1,022	1,160	1,278	1,519	1,238
		Nesting	01TC3660T26NE	1,421	1,556	1,672	NA	1,698
	36 x 72	Static	01TC3672T26	801	956	1,089	1,386	1,082
		Folding	01TC3672T26FD	1,064	1,220	1,353	1,650	1,359
		Nesting	01TC3672T26NE	1,482	1,635	1,765	NA	1,837
36 x 84	Static	01TC3684T26	962	1,154	1,287	1,585	1,175	
	Folding	01TC3684T26FD	1,157	1,350	1,482	1,781	1,380	
	Nest/Lightwt	01TC3684T26NE-LT	1,687	NA	2,017	NA	NA	
36 x 90	Static	01TC3690T26	1,029	1,248	1,375	1,651	1,185	
	Folding	01TC3690T26FD	1,224	1,443	1,570	1,846	1,390	
	Nest/Lightwt	01TC3690T26NE-LT	1,752	NA	2,103	NA	NA	
36 x 96	Static	01TC3696T26	1,029	1,248	1,388	1,716	1,191	
	Folding	01TC3696T26FD	1,224	1,443	1,584	1,911	1,396	
	Nest/Lightwt	01TC3696T26NE-LT	1,752	NA	2,116	NA	NA	





Rectangular with TT-bases	Top Size	Base	Model Number	3P	3K	3W	W1-W4	F1-F5
 	42 x 60	Static	01TC4260TT34	\$ 992	\$ 1,153	\$ 1,267	\$ 1,511	1,134
		Nesting	01TC4260TT34NE	1,770	1,929	2,041	NA	1,994
	42 x 72	Static	01TC4272TT34	1,072	1,266	1,384	1,653	1,265
		Nesting	01TC4272TT34NE	1,850	2,040	2,156	NA	2,123
	42 x 84	Static	01TC4284TT34	1,218	1,443	1,565	1,864	1,358
	42 x 90	Static	01TC4290TT34	1,293	1,548	1,662	1,933	1,379
	42 x 96	Static	01TC4296TT34	1,293	1,548	1,675	2,006	1,390
	48 x 60	Static	01TC4860TT36	1,049	1,234	1,345	1,595	1,245
		Nesting	01TC4860TT36NE	1,770	1,929	2,055	NA	2,104
	48 x 72	Static	01TC4872TT36	1,142	1,364	1,474	1,749	1,377
		Nesting	01TC4872TT36NE	1,850	2,040	2,169	NA	2,233
	48 x 84	Static	01TC4884TT36	1,218	1,443	1,579	1,967	1,470
48 x 90	Static	01TC4890TT36	1,294	1,550	1,677	2,044	1,512	
48 x 96	Static	01TC4896TT36	1,294	1,550	1,690	2,121	1,522	







new

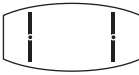

- LC +90
- CCG +120
- BN +65
- OS +35
- CH +100
- WM +125
- WMLC +45
- SH T+130 TT+260
- FR NA
- PB NA
- GR +40
- CM +50
- RC +55
- GN +40
- LT +115
- AH T+250
- RA T+365
- NU T+700

Top Size	Base	Model Number	3P	3K	3W	W1-W4	F1-F5	Rectangular with 3 TT-bases
42 x 120	Static	01TC42120TT34(3)	\$ 1,867	\$ 2,246	\$ 2,336	\$ 2,551	2,332	 
42 x 144	Static	01TC42144TT34(3)	2,022	2,463	2,562	2,832	2,353	
48 x 120	Static	01TC48120TT36(3)	1,877	2,259	2,360	2,690	2,385	
48 x 144	Static	01TC48144TT36(3)	2,034	2,479	2,588	2,990	2,438	

3 bases: **LC** **SH** **CH**  
+135 quote +150

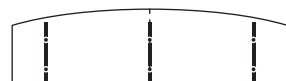

Top Size	Base	Model Number	3P	3K	3W	W1-W4	F1-F5	Boat-Shaped with T-bases
30 x 42 x 84	Static	01BT3084T26	\$ 1,245	\$ 1,550	\$ 1,570	\$ 2,289	\$ 1,309	 
30 x 42 x 90	Static	01BT3090T26	1,353	1,702	1,703	2,389	1,335	
30 x 42 x 96	Static	01BT3096T26	1,353	1,702	1,717	2,486	1,347	

Top Size	Base	Model Number	3P	3K	3W	W1-W4	F1-F5	Boat-Shaped with TT-bases
36 x 48 x 84	Static	01BT3684TT34	\$ 1,526	\$ 1,875	\$ 1,871	\$ 2,606	\$ 1,505	 
36 x 48 x 90	Static	01BT3690TT34	1,649	2,047	2,020	2,710	1,558	
36 x 48 x 96	Static	01BT3696TT34	1,649	2,047	2,034	2,810	1,570	

Top Size	Base	Model Number	3P	3K	3W	W1-W4	F1-F5	Boat-Shaped with 3 TT-bases
36 x 48 x 120	Static	01BT36120TT36(3)	\$ 2,314	\$ 2,872	\$ 2,794	\$ 3,483	2,385	 
36 x 48 x 144	Static	01BT36144TT36(3)	2,561	3,217	3,121	3,894	2,438	



3 bases: **LC** **SH** **CH**  
+135 quote +150

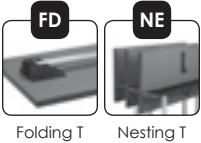

- LC**  
+90
- CCG**  
+120
- BN**  
+65
- OS**  
NA
- CH**  
+100
- WM**  
+125
- WMLC**  
+45
- SH**  
T+130  
TT+260
- FR**  
NA
- PB**  
NA
- GR**  
+40
- CM**  
+50
- RC**  
+55
- GN**  
+40
- LT**  
+115
- AH**  
T+250
- RA**  
T+365
- NU**  
T+700

Racetrack with T-bases	Top Size	Base	Model Number	3P	3K	3W	W1-W4	F1-F5
 	36 x 60	Static	01RT3660T26	\$ 886	\$ 1,075	\$ 1,119	\$ 1,717	\$ 1,067
		Nesting	01RT3660T26NE	1,491	1,677	1,720	NA	1,745
	36 x 72	Static	01RT3672T26	977	1,202	1,247	1,898	1,212
		Folding	01RT3672T26FD	1,240	1,466	1,510	2,161	1,489
		Nesting	01RT3672T26NE	1,635	1,856	1,900	NA	1,945
	36 x 84	Static	01RT3684T26	1,139	1,403	1,447	2,151	1,309
		Folding	01RT3684T26FD	1,335	1,598	1,642	2,346	1,514
	36 x 90	Static	01RT3690T26	1,261	1,574	1,595	2,243	1,322
		Folding	01RT3690T26FD	1,457	1,769	1,790	2,439	1,527
	36 x 96	Static	01RT3696T26	1,261	1,574	1,609	2,332	1,328
		Folding	01RT3696T26FD	1,457	1,769	1,804	2,527	1,534



Foundation

Racetrack with TT-bases	Top Size	Base	Model Number	3P	3K	3W	W1-W4	F1-F5
 	42 x 84	Static	01RT4284TT34	\$ 1,416	\$ 1,721	\$ 1,742	\$ 2,464	\$ 1,492
	42 x 90	Static	01RT4290TT34	1,527	1,876	1,878	2,564	1,518
	42 x 96	Static	01RT4296TT34	1,527	1,876	1,891	2,660	1,531
	48 x 84	Static	01RT4884TT34	1,649	2,047	2,006	2,606	1,505
	48 x 90	Static	01RT4890TT34	1,649	2,047	2,020	2,710	1,556
	48 x 96	Static	01RT4896TT34	1,649	2,047	2,034	2,810	1,569

Racetrack with 3 TT-bases	Top Size	Base	Model Number	3P	3K	3W	W1-W4	F1-F5
 	42 x 120	Static	01RT42120TT34(3)	\$ 2,301	\$ 2,853	\$ 2,771	\$ 3,310	2,332
	42 x 144	Static	01RT42144TT34(3)	2,545	3,195	3,095	3,698	2,353
	48 x 120	Static	01RT48120TT36(3)	2,315	2,873	2,794	3,483	2,385
	48 x 144	Static	01RT48144TT36(3)	2,561	3,218	3,121	3,894	2,438

3 bases: **LC** **SH** **CH**  
+135 quote +150

- LC**  
+90
- CCG**  
+120
- BN**  
+65
- OS**  
NA
- CH**  
+100
- WM**  
+125
- WMLC**  
+45
- SH**  
T+130  
TT+260
- FR**  
NA
- PB**  
NA
- GR**  
+40
- CM**  
+50
- RC**  
NA
- GN**  
NA
- LT**  
+115
- AH**  
T+250
- RA**  
T+365
- NU**  
T+700

Top Size	Base	Model Number	3P	3K	3W	W1-W4	F1-F5	Elliptical with T-bases
30 x 54	Static	01EL3054T22	\$ 766	\$ 909	\$ 954	\$ 1,510	\$ 838	
30 x 60	Static	01EL3060T22	804	961	1,006	1,595	862	
36 x 60	Static	01EL3660T26	886	1,075	1,107	1,717	961	
36 x 72	Static	01EL3672T26	977	1,202	1,229	1,898	1,082	
36 x 84	Static	01EL3684T26	1,139	1,403	1,423	2,151	1,175	
36 x 90	Static	01EL3690T26	1,261	1,574	1,568	2,243	1,221	
36 x 96	Static	01EL3696T26	1,261	1,574	1,579	2,332	1,246	

Top Size	Base	Model Number	3P	3K	3W	W1-W4	F1-F5	Elliptical with TT-bases
42 x 72	Static	01EL4272TT26	\$ 1,187	\$ 1,450	\$ 1,459	\$ 2,144	\$ 1,203	
42 x 84	Static	01EL4284TT26	1,357	1,662	1,662	2,405	1,296	
42 x 90	Static	01EL4290TT26	1,470	1,820	1,797	2,505	1,317	
42 x 96	Static	01EL4296TT26	1,470	1,820	1,808	2,601	1,328	
48 x 72	Static	01EL4872TT30	1,340	1,652	1,635	2,306	1,347	
48 x 84	Static	01EL4884TT30	1,420	1,737	1,738	2,578	1,440	
48 x 90	Static	01EL4890TT30	1,622	2,020	1,972	2,682	1,482	
48 x 96	Static	01EL4896TT30	1,622	2,020	1,982	2,782	1,493	

Top Size	Base	Model Number	3P	3K	3W	W1-W4	F1-F5	Elliptical with 3 TT-bases
42 x 120	Static	01EL42120TT34(3)	\$ 2,301	\$ 2,853	\$ 2,733	\$ 3,310	2,332	
42 x 144	Static	01EL42144TT34(3)	2,545	3,195	3,045	3,698	2,353	
48 x 120	Static	01EL48120TT36(3)	2,315	2,873	2,759	3,483	2,385	
48 x 144	Static	01EL48144TT36(3)	2,561	3,218	3,074	3,894	2,438	

3 bases: **LC** **SH** **CH**  
+135 quote +150

- LC**  
+90
- CCG**  
+120
- BN**  
+65
- OS**  
NA
- CH**  
+100
- WM**  
+125
- WMLC**  
+45
- SH**  
T+130  
TT+260
- FR**  
NA
- PB**  
NA
- GR**  
+40
- CM**  
+50
- RC**  
NA
- GN**  
NA
- LT**  
+115
- AH**  
T+250
- RA**  
T+365
- NU**  
T+700



Square with X-base		Top Size	Base	Model Number	3P	3K	3W	W1-W4	F1-F5
  Flip Top X	24 x 24	Static	01SQ2424X22	\$ 430	\$ 468	\$ 550	\$ 680	\$ 477	
		Flip Top	01SQ2424X22FT	556	594	676	806	609	
	30 x 30	Static	01SQ3030X26	487	546	640	797	539	
		Flip Top	01SQ3030X26FT	613	672	766	923	671	
	36 x 36	Static	01SQ3636X32	566	650	753	938	706	
		Flip Top	01SQ3636X32FT	692	776	879	1,063	838	
	42 x 42	Static	01SQ4242X36	652	765	874	1,085	741	
		Flip Top	01SQ4242X36FT	778	891	1,000	1,211	873	
	48 x 48	Static	01SQ4848X38	755	902	1,013	1,246	781	

Square with disc base		Top Size	Base	Model Number	3P	3K	3W	W1-W4	F1-F5
  Counterbalanced & Short Balanced Height Adj.	24 x 24	Static	44SQ2424D20	\$ 688	\$ 727	\$ 809	\$ 939	\$ 748	
		Short Bal	44SQ2424D20BLS	1,086	1,124	1,206	1,336	1,166	
	30 x 30	Static	44SQ3030D24	779	838	933	1,090	846	
		Short Bal	44SQ3030D24BLS	1,386	1,445	1,540	1,697	1,484	
	36 x 36	Static	44SQ3636D24	842	926	1,029	1,213	996	
		Short Bal	44SQ3636D24BLS	1,449	1,533	1,636	1,820	1,633	
		Count Bal	44SQ3636D24BL	1,449	1,533	1,636	1,820	1,633	
	42 x 42	Static	44SQ4242D32	1,042	1,155	1,264	1,475	1,150	
		Short Bal	44SQ4242D32BLS	1,638	1,751	1,860	2,070	1,775	
		Count Bal	44SQ4242D32BL	1,638	1,751	1,860	2,070	1,775	



Square with 4-column X-base		Top Size	Base	Model Number	3P	3K	3W	W1-W4	F1-F5
 X,4 bases: SH CH +260 NA	54 x 54	Static	01SQ5454X36.4	\$ 1,037	\$ 1,222	\$ 1,333	\$ 1,586	NA	
	60 x 60	Static	01SQ6060X42.4	1,175	1,402	1,509	1,783	NA	

Square with TT-bases		Top Size	Base	Model Number	3P	3K	3W	W1-W4	F1-F5
  Nesting TT	48 x 48	Static	01SQ4848TT34	\$ 954	\$ 1,101	\$ 1,213	\$ 1,445	\$ 991	
		Nesting	01SQ4848TT34NE	1,734	1,878	1,988	NA	1,854	

- LC +90
- CCG +120
- BN +65
- OS NA
- CH +100
- WM +125
- WMLC +45
- SH X+65 TT+260
- FR +150
- PB +90
- GR +40
- CM +50
- RC +55
- GN +40
- LT +115
- AH X+125
- RA NA
- NU X+350



Top Size	Base	Model Number	3P	3K	3W	W1-W4	F1-F5	Round with X-base
24 x 24	Static	01RD24X22	\$ 462	\$ 513	\$ 561	\$ 888	\$ 477	 
	Flip Top	01RD24X22FT	587	638	687	1,014	609	
30 x 30	Static	01RD30X26	537	616	666	1,075	539	
	Flip Top	01RD30X26FT	663	742	791	1,200	671	
36 x 36	Static	01RD36X30	626	735	784	1,290	705	
	Flip Top	01RD36X30FT	752	861	910	1,416	837	
42 x 42	Static	01RD42X32	725	873	914	1,511	727	
	Flip Top	01RD42X32FT	851	999	1,040	1,637	859	
48 x 48	Static	01RD48X36	765	924	979	1,762	762	





Top Size	Base	Model Number	3P	3K	3W	W1-W4	F1-F5	Round with disc base
24 x 24	Static	44RD24D20	\$ 720	\$ 771	\$ 820	\$ 1,146	\$ 748	   <p>disc base: <b>CH</b> <b>SH</b> +400 +65</p> <p>Counterbalanced &amp; Short Balanced Height Adj.</p>
	Short Bal	44RD24D20BLS	1,118	1,169	1,218	1,544	1,166	
30 x 30	Static	44RD30D20	790	869	918	1,327	804	
	Short Bal	44RD30D20BLS	1,188	1,267	1,316	1,725	1,222	
36 x 36	Static	44RD36D20	863	972	1,021	1,527	954	
	Short Bal	44RD36D20BLS	1,261	1,370	1,419	1,925	1,372	
	Count Bal	44RD36D20BL	1,261	1,370	1,419	1,925	1,372	
42 x 42	Static	44RD42D24	1,001	1,148	1,190	1,787	1,017	
	Short Bal	44RD42D24BLS	1,608	1,755	1,797	2,394	1,654	
	Count Bal	44RD42D24BL	1,608	1,755	1,797	2,394	1,654	
48 x 48	Static	44RD48D32	1,155	1,314	1,369	2,152	1,171	
	Short Bal	44RD48D32BLS	1,751	1,909	1,964	2,747	1,796	
	Count Bal	44RD48D32BL	1,751	1,909	1,964	2,747	1,796	





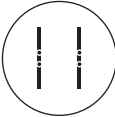



Foundation

**ITGW**

Top Size	Base	Model Number	3P	3K	3W	W1-W4	F1-F5	Round with 4-column X-base
54 x 54	Static	01RD54X32.4	\$ 1,084	\$ 1,306	\$ 1,335	\$ 2,183	NA	  <p>X.4 bases: <b>SH</b> <b>CH</b> +260 NA</p>
60 x 60	Static	01RD60X36.4	1,152	1,383	1,428	2,506	NA	

Top Size	Base	Model Number	3P	3K	3W	W1-W4	F1-F5	Round with TT-bases
48 x 48	Static	01RD48TT26	\$ 924	\$ 1,083	\$ 1,138	\$ 1,921	\$ 929	    <p>Folding TT Nesting TT</p>
	Nesting	01RD48TT26NE	1,705	1,860	1,914	NA	1,793	
54 x 54	Static	01RD54TT30	1,115	1,337	1,366	2,214	NA	
	Nesting	01RD54TT30NE	1,891	2,109	2,138	NA	NA	
60 x 60	Static	01RD60TT34	1,165	1,396	1,440	2,519	NA	
	Folding	01RD60TT34FD	1,747	1,979	2,023	NA	NA	
	Nesting	01RD60TT34NE	1,941	2,167	2,211	NA	NA	

- LC**  
+90
- CCG**  
+120
- BN**  
+65
- OS**  
NA
- CH**  
+100
- WM**  
+125
- WMLC**  
+45
- SH**  
X+65  
TT+260
- FR**  
+150
- PB**  
+90
- GR**  
+40
- CM**  
+50
- RC**  
NA
- GN**  
NA
- LT**  
+115
- AH**  
X+125
- RA**  
NA
- NU**  
X+350

D-shaped with T-bases	Top Size	Base	Model Number	3P	3K	3W	W1-W4	F1-F5
	24 x 36	Static	01D2436T20	\$ 597	\$ 672	\$ 743	\$ 1,033	\$ 646
		Nesting	01D2436T20NE	1,022	1,095	1,164	NA	1,111
	24 x 48	Static	01D2448T20	660	760	839	1,168	719
		Nesting	01D2448T20NE	1,083	1,181	1,259	NA	1,182
	24 x 60	Static	01D2460T20	722	847	936	1,303	792
		Nesting	01D2460T20NE	1,171	1,294	1,381	NA	1,282
	24 x 72	Static	01D2472T20	785	935	1,032	1,437	865
		Nesting	01D2472T20NE	1,327	1,474	1,569	NA	1,478
	24 x 84	Static	01D2484T20	915	1,090	1,197	1,640	1,010
		Nesting	01D2484T20NE	1,528	1,700	1,804	NA	1,696
	24 x 90	Static	01D2490T20	947	1,134	1,245	1,709	1,046
		Nesting	01D2490T20NE	1,559	1,742	1,851	NA	1,732
	24 x 96	Static	01D2496T20	978	1,178	1,293	1,779	1,082
		Nesting	01D2496T20NE	1,589	1,785	1,898	NA	1,768
	30 x 48	Static	01D3048T26	725	850	922	1,267	795
		Nesting	01D3048T26NE	1,147	1,270	1,340	NA	1,257
	30 x 60	Static	01D3060T26	803	960	1,035	1,413	865
		Nesting	01D3060T26NE	1,251	1,404	1,478	NA	1,354
	30 x 72	Static	01D3072T26	881	1,069	1,149	1,559	977
		Nesting	01D3072T26NE	1,421	1,605	1,684	NA	1,588
	30 x 84	Static	01D3084T26	1,028	1,247	1,331	1,774	1,140
		Nesting	01D3084T26NE	1,638	1,853	1,935	NA	1,824
	30 x 90	Static	01D3090T26	1,067	1,301	1,388	1,847	1,186
		Nest/Lightwt	01D3090T26NE-LT	1,752	NA	NA	NA	NA
	30 x 96	Static	01D3096T26	1,106	1,356	1,444	1,920	1,231
		Nest/Lightwt	01D3096T26NE-LT	1,828	NA	NA	NA	NA
	36 x 48	Static	01D3648T26	788	938	1,001	1,363	868
		Nesting	01D3648T26NE	1,208	1,355	1,418	NA	1,328
	36 x 60	Static	01D3660T26	881	1,069	1,132	1,521	977
		Nesting	01D3660T26NE	1,449	1,633	1,695	NA	1,592
	36 x 72	Static	01D3672T26	975	1,200	1,263	1,675	1,082
		Nesting	01D3672T26NE	1,634	1,854	1,916	NA	1,817
	36 x 84	Static	01D3684T26	1,137	1,399	1,462	1,901	1,175
		Nest/Lightwt	01D3684T26NE-LT	1,858	NA	NA	NA	NA
	36 x 90	Static	01D3690T26	1,184	1,465	1,527	1,982	1,329
		Nest/Lightwt	01D3690T26NE-LT	1,905	NA	NA	NA	NA
	36 x 96	Static	01D3696T26	1,231	1,531	1,593	2,059	1,339
		Nest/Lightwt	01D3696T26NE-LT	1,950	NA	NA	NA	NA





NEW

Foundation

- LC**  
+90
- CCG**  
+120
- BN**  
+65
- OS**  
T+35
- CH**  
+100
- WM**  
+125
- WMLC**  
+45
- SH**  
T+130
- FR**  
NA
- PB**  
NA
- GR**  
+40
- CM**  
+50
- RC**  
+55
- GN**  
+40
- LT**  
+115
- AH**  
T+250
- RA**  
T+365
- NU**  
T+700

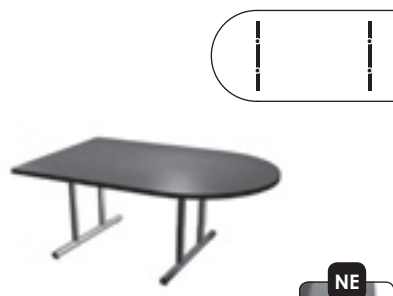



Top Size	Base	Model Number	3P	3K	3W	W1-W4	F1-F5	D-shaped with TT-bases	
42 x 60	Static	01D4260TT34	\$ 1,134	\$ 1,353	\$ 1,403	\$ 1,799	\$ 1,252		
	Nesting	01D4260TT34NE	1,910	2,125	2,174	NA	2,110		
42 x 72	Static	01D4272TT34	1,243	1,506	1,551	1,969	1,265		
	Nesting	01D4272TT34NE	2,017	2,275	2,320	NA	2,123		
42 x 84	Static	01D4284TT34	1,521	1,868	1,878	2,202	1,358		
42 x 90	Static	01D4290TT34	1,583	1,955	1,960	2,287	1,379		
42 x 96	Static	01D4296TT34	1,645	2,041	2,042	2,371	1,522		
48 x 60	Static	01D4860TT36	1,212	1,462	1,500	1,907	1,343		 Nesting TT
	Nesting	01D4860TT36NE	1,987	2,232	2,269	NA	2,199		
48 x 72	Static	01D4872TT36	1,337	1,637	1,665	2,084	1,377		
	Nesting	01D4872TT36NE	2,109	2,404	2,431	NA	2,233		
48 x 84	Static	01D4884TT36	1,530	1,880	1,899	2,333	1,470		
48 x 90	Static	01D4890TT36	1,593	1,968	1,981	2,510	1,512		
48 x 96	Static	01D4896TT36	1,655	2,055	2,064	2,510	1,522		



Foundation

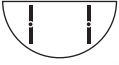

Top Size	Base	Model Number	3P	3K	3W	W1-W4	F1-F5	D-shaped with 4-column X-base
54 x 54	Static	01D5454X36.4	\$ 1,348	\$ 1,657	\$ 1,662	\$ 1,910	\$ NA	
60 x 60	Static	01D6060X42.4	1,387	1,699	1,712	2,141	NA	

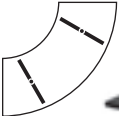

X.4 bases: **SH** **CH**  
+260 NA

- LC**  
+90
- CCG**  
+120
- BN**  
+65
- OS**  
T+35
- CH**  
+100
- WM**  
+125
- WMLC**  
+45
- SH**  
TT+260
- FR**  
NA
- PB**  
NA
- GR**  
+40
- CM**  
+50
- RC**  
+55
- GN**  
+40
- LT**  
+115
- AH**  
NA
- RA**  
NA
- NU**  
NA

Half Round with T-bases	Top Size	Base	Model Number	3P	3K	3W	W1-W4	F1-F5
   Nesting T	18 x 36	Static	01HR1836T16	\$ 603	\$ 682	\$ 730	\$ 1,181	\$ 589
	24 x 48	Static	01HR2448T16	660	761	828	1,481	716
		Nesting	01HR2448T16NE	1,083	1,182	1,248	NA	1,179
	30 x 60	Static	01HR3060T20	802	959	1,019	1,803	883
		Nesting	01HR3060T22NE	1,222	1,376	1,435	NA	1,343
	36 x 72	Static	01HR3672T26	974	1,199	1,244	2,152	1,087
Nesting		01HR3672T26NE	1,578	1,798	1,842	NA	1,699	

Crescent with T-bases	Top Size	Base	Model Number	3P	3K	3W	W1-W4	F1-F5
 	24 x 48 x 75	Static	01CS2475T22	\$ 1,205	\$ 1,523	\$ 1,470	\$ 1,807	\$ 1,570
	24 x 60 x 94	Static	01CS2494T22	1,528	1,975	1,875	2,084	1,570
	30 x 60 x 94	Static	01CS3094T26	1,531	1,978	1,875	2,244	1,573

Trapezoid with T-bases	Top Size	Base	Model Number	3P	3K	3W	W1-W4	F1-F5
   Nesting T	24 x 48	Static	01TZ2448T18	\$ 652	\$ 749	\$ 815	\$ 1,261	\$ 716
	24 x 72	Static	01TZ2472T18	810	972	1,045	1,600	862
		Nesting	01TZ2472T18NE	1,258	1,416	1,487	NA	1,351
	30 x 60	Static	01TZ3060T22	760	901	969	1,572	883
		Nesting	01TZ3060T22NE	1,182	1,319	1,386	NA	1,343
	36 x 72	Static	01TZ3672T26	952	1,167	1,213	1,917	1,087
Nesting		01TZ3672T26NE	1,529	1,740	1,785	NA	1,735	

Corner with T-bases	Top Size	Base	Model Number	3P	3K	3W	W1-W4	F1-F5
 	24 x 42	Static	01CR2442T30	\$ 858	\$ 1,026	\$ 1,085	\$ 1,743	712
	30 x 48	Static	01CR3048T36	970	1,151	1,228	2,094	904

- LC +90
- CCG +120
- BN +65
- OS +35
- CH +100
- WM +125
- WMLC +45
- SH T+130
- FR NA
- PB NA
- GR +40
- CM +50
- RC +55
- GN +40
- LT NA
- AH T+250
- RA T+365
- NU T+700

Top Size	Base	Model Number	3P	3K	3W	W1-W4	F1-F5	Arc Segment with T-bases
20 x 44	Static	01AS2044T18	\$ 685	\$ 796	\$ 828	NA	\$ 647	
24 x 51	Static	01AS2451T20	757	896	924	NA	744	
30 x 59	Static	01AS3059T26	829	996	1,027	NA	886	
36 x 67	Static	01AS3667T26	996	1,229	1,252	NA	1,087	

Top Size	Base	Model Number	3P	3K	3W	W1-W4	F1-F5	Ganging Quarter Round (with T-base)
20 x 20	Ganging	QR2020GN	\$ 224	\$ 272	\$ 319	NA	\$ 236	
24 x 24	Ganging	QR2424GN	233	284	344	NA	236	
30 x 30	Static, GN	01QR3030GNT20	477	556	620	NA	477	
	Ganging	QR3030GN	301	380	444	NA	292	
36 x 36	Static, GN	01QR3636GNT20	541	645	716	NA	627	
	Ganging	QR3636GN	365	469	540	NA	442	

1 base: **LC** NA **CCG** NA **BN** +33 **OS** +18 **CH** +50 **SH** +65

**GN**  
Ganging included

Top Size	Base	Model Number	3P	3K	3W	W1-W4	F1-F5	Ganging 45° Wedge (with T-base)
20 x 20	Ganging	WG45D20GN	\$ 224	\$ 272	\$ 315	NA	\$ 236	
24 x 24	Ganging	WG45D24GN	233	284	337	NA	236	
30 x 30	Ganging	WG45D30GN	301	380	432	NA	292	
36 x 36	Static, GN	01WG45D36GNT20	541	645	697	NA	627	
	Ganging	WG45D36GN	365	469	520	NA	442	

1 base: **LC** NA **CCG** NA **BN** +33 **OS** +18 **CH** +50 **SH** +65



**GN**  
Ganging included



Top Size	Base	Model Number	3P	3K	3W	W1-W4	F1-F5	Ganging 60° Wedge (with T-base)
20 x 20	Ganging	WG60D20GN	\$ 246	\$ 302	\$ 343	NA	\$ 236	
24 x 24	Ganging	WG60D24GN	254	314	366	NA	236	
30 x 30	Static, GN	01WG60D30GNT20	499	586	638	NA	477	
	Ganging	WG60D30GN	322	410	462	NA	292	
36 x 36	Static, GN	01WG60D36GNT20	563	675	729	NA	627	
	Ganging	WG30D36GN	386	499	553	NA	442	



1 base: **LC** NA **CCG** NA **BN** +33 **OS** +18 **CH** +50 **SH** +65

**GN**  
Ganging included



- LC** +90
- CCG** +120
- BN** +65
- OS** +35
- CH** +100
- WM** +125
- WMLC** +45
- SH** T+130
- FR** NA
- PB** NA
- GR** +40
- CM** +50
- RC** +55
- GN** +40
- LT** NA
- AH** T+250
- RA** T+365
- NU** T+700

Video Wedge with T-bases	Top Size	Base	Model Number	3P	3K	3W	W1-W4	F1-F5
 	20 x 20 x 40	Static	01VW2040T18	\$ 642	\$ 736	\$ 796	NA	\$ 627
	24 x 24 x 48	Static	01VW2448T20	688	799	871	NA	719
	30 x 30 x 60	Static	01VW3060T26	829	996	1,066	NA	886
	36 x 36 x 72	Static	01VW3672T26	1,079	1,346	1,380	NA	1,087

10° Transition with T-bases	Top Size	Base	Model Number	3P	3K	3W	W1-W4	F1-F5
 	20 x 30	Static	01TN2030T18	\$ 546	\$ 601	\$ 667	NA	\$ 577
	24 x 30	Static	01TN2430T20	559	619	690	NA	610
	30 x 30	Static	01TN3030T26	618	700	765	NA	658
	36 x 30	Static	01TN3630T26	682	789	847	NA	704



Trident with 3 Offset T-bases	Top Size	Base	Model Number	3P	3K	3W	W1-W4	F1-F5
 	36 x 36 x 18	Static	01TR3618TOS16(3)	\$ 1,117	\$ 1,309	\$ 1,293	\$ 1,649	\$ 1,006
	40 x 40 x 20	Static	01TR4020TOS16(3)	1,223	1,457	1,423	1,772	1,271
	48 x 48 x 24	Static	01TR4824TOS16(3)	1,236	1,475	1,466	2,045	1,271
	60 x 60 x 30	Static	01TR6030TOS16(3)	1,423	1,738	1,715	2,480	NA



3 bases: **LC** **SH** **CH**  
 +135 +195 +150

Quadrant with 4-Column X-base	Top Size	Base	Model Number	3P	3K	3W	W1-W4	F1-F5
 	60 x 60 x 18	Static	01QD6018X36.4	\$ 1,404	\$ 1,736	\$ 1,722	\$ 2,575	NA
	60 x 60 x 20	Static	01QD6020X36.4	1,404	1,736	1,724	2,575	NA
	60 x 60 x 24	Static	01QD6024X36.4	1,404	1,736	1,728	2,575	NA
	60 x 60 x 30	Static	01QD6030X36.4	1,404	1,736	1,734	2,575	NA

X.4 bases: **SH** **CH**  
 +260 NA



- LC**  
+90
- CCG**  
+120
- BN**  
+65
- OS**  
T+35
- CH**  
+100
- WM**  
+125
- WMLC**  
+45
- SH**  
T+130
- FR**  
NA
- PB**  
NA
- GR**  
+40
- CM**  
+50
- RC**  
+55
- GN**  
+40
- LT**  
NA
- AH**  
T+250
- RA**  
T+365
- NU**  
T+700



Top Size	Base	Model Number	3P	3K	3W	W1-W4	F1-F5	Bulb with X-base
24 x 24 x 18	Static	01BU2418X22	\$ 662	\$ 793	\$ 786	\$ 1,254	\$ 494	 
30 x 30 x 20	Static	01BU3020X26	706	852	857	1,517	582	
36 x 36 x 24	Static	01BU3624X30	827	1,016	1,011	1,798	698	
42 x 42 x 30	Static	01BU4230X32	925	1,153	1,142	2,084	818	
48 x 48 x 36	Static	01BU4836X36	951	1,184	1,192	2,385	968	

Top Size	Base	Model Number	3P	3K	3W	W1-W4	F1-F5	Squire with X-base
24 x 24	Static	01SL24X22	\$ 615	\$ 727	\$ 754	\$ NA	\$ 477	 
	Flip Top	01SL24X22FT	741	853	880	NA	609	
30 x 30	Static	01SL30X26	669	801	841	NA	539	
	Flip Top	01SL30X26FT	795	927	966	NA	671	
36 x 36	Static	01SL36X32	740	893	945	NA	706	
	Flip Top	01SL36X32FT	866	1,019	1,070	NA	838	
42 x 42	Static	01SL42X36	812	989	1,050	NA	741	
	Flip Top	01SL42X36FT	938	1,115	1,176	NA	873	
48 x 48	Static	01SL48X38	901	1,106	1,174	NA	781	

Foundation

**new**

Top Size	Base	Model Number	3P	3K	3W	W1-W4	F1-F5	Teardrop with X-base
24 x 48	Static	01TE2448X3236	\$ 797	\$ 965	\$ 1,025	NA	\$ 686	 

Top Size	Base	Model Number	3P	3K	3W	W1-W4	F1-F5	Table Desk with T-bases
37 x 60	Static	01TA3760T26	\$ 876	\$ 1,061	\$ 1,168	\$ 1,860	\$ 993	 
42 x 78	Static	01TA4278T30	1,224	1,511	1,600	2,376	1,422	

- LC**  
+90
- CCG**  
+120
- BN**  
+65
- OS**  
T+35
- CH**  
+100
- WM**  
+125
- WMLC**  
+45
- SH**  
X+65  
T+130
- FR**  
NA
- PB**  
+90
- GR**  
+40
- CM**  
+50
- RC**  
+55
- GN**  
+40
- LT**  
NA
- AH**  
X+125  
T+250
- RA**  
T+365
- NU**  
X+350  
T+700



tableX PRESS

Select Fundamental tables are available on our 5-day quickship program. See page 204 for details.

Large installations often dictate the need for a durable, versatile, and budget conscious table option. Fundamental meets these needs in addition to making installations easy.

Fundamental

## Fundamental Base Styles



## Fundamental Base Options

standard glides



**LC Locking Casters**  
can be added to any table for \$90.

**OS Offset Bases**  
available for \$35.

**SH Special Height**  
of can be added to any table:  
+ \$65 per column for heights > 29"  
+ \$35 per column for heights < 29"  
Special height tables larger than 36x72" must be custom quoted.

locking casters



**CCG Concealed Casters**  
available on one T-base for \$120 per table. Standard glides on opposite base.

**CH Chrome Finish**  
available for \$100 on most models. Upcharge for disc bases is \$400.

**WM Wire Management**  
Built in wire management is available on one leg for \$125.

**FR Footring**  
available on standing height disc-bases for \$150. Not available in chrome.

concealed casters



**NE Nesting Tables**  
priced accordingly with locking casters.

**WMLC Wire Management Leg Covers**  
snap onto any leg and are \$45 each.

**PB Power Box Mounting Plate**  
is available on disc & X-bases for \$90.

**FT Flip Tops**  
available on X-based tables and are priced with standard glides.

## Fundamental Height Adjustable Options

- NU Pneumatic** is available on X-bases for \$350 and on T-bases for \$700 per table.
- AH Spring Clip** is available on X-bases for \$125 and on T-bases for \$250 per table.
- RA Ratchet** is available on T-bases & nesting for \$365 per table and are available in three finishes:
  - 02 Black
  - 30 Pearl
  - 37 Satin Silver
- BL Counterbalanced and short balanced** are available on disc bases and are available in three finishes:
  - 02 Black
  - 30 Pearl
  - 37 Satin Silver

## Fundamental Top Shapes

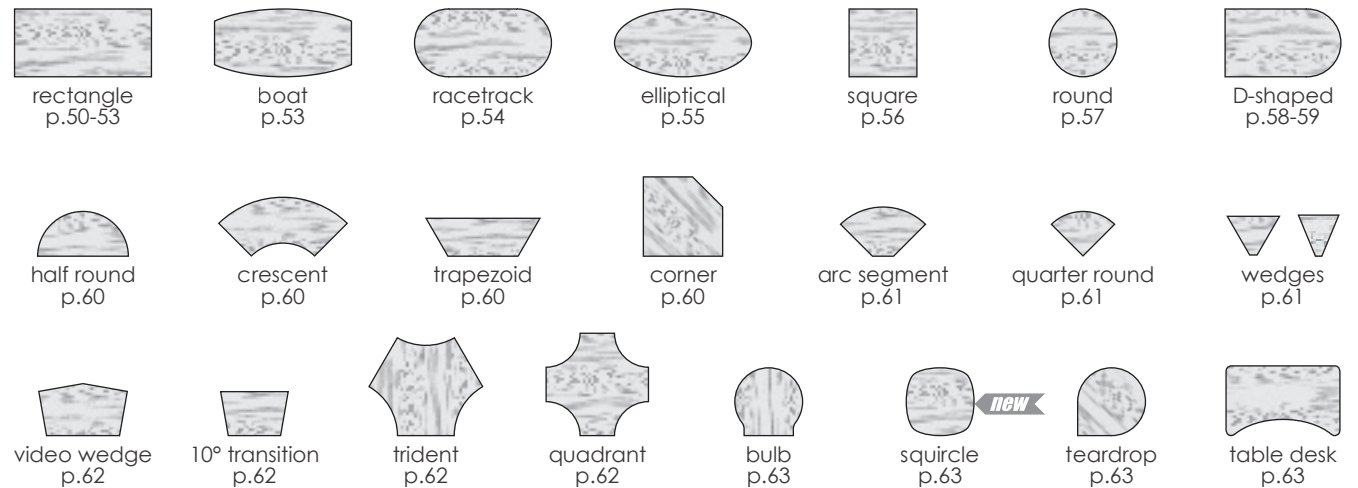

Fundamental

## Fundamental Top Options

- RC 3" Radius Corners** can be added to any table for \$55.
- GN Ganging Brackets** can be added to most table shapes for \$40.
- LT Lightweight Tops** can be added to any square or rectangular table for \$115. This is a great option when specifying folding tables.
- GR Grommets** can be added to any table for \$40 each. To see specific locations, see page 203.
- CM Cable Manager** can be added to any table for \$50 each. To see specific locations, see page 203.

## Fundamental Edge Options

(correspond with 5 columns of pricing)

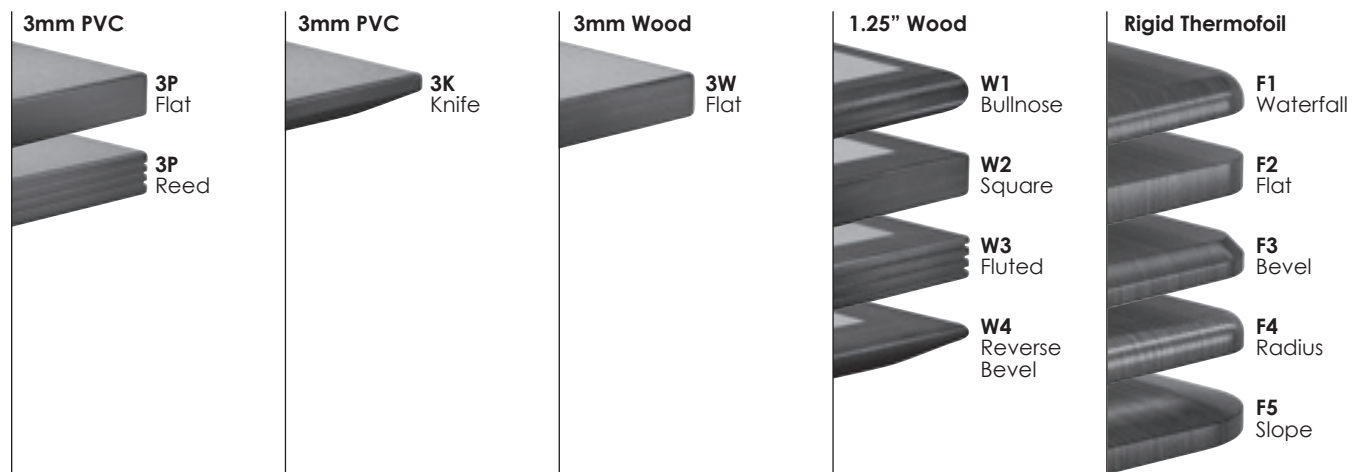



Rectangular with T-bases	Top Size	Base	Model Number	3P	3K	3W	W1-W4	F1-F5
    <p>Folding T    Nesting T</p>	18 x 36	Static	O2TC1836T16	\$ 470	\$ 512	\$ 601	\$ 746	\$ 517
		Nesting	O2TC1836T18NE	883	924	1,011	NA	968
		18 x 48	Static	O2TC1848T16	504	560	666	839
	Folding		O2TC1848T16FD	749	804	910	1,083	798
	Nesting		O2TC1848T18NE	942	996	1,100	NA	1,020
	18 x 60	Static	O2TC1860T16	538	607	730	935	605
		Folding	O2TC1860T16FD	793	862	984	1,190	872
		Nesting	O2TC1860T18NE	1,030	1,097	1,217	NA	1,139
	18 x 72	Static	O2TC1872T16	572	654	793	1,032	694
		Folding	O2TC1872T16FD	827	909	1,048	1,287	961
		Nesting	O2TC1872T18NE	1,235	1,315	1,452	NA	1,431
	18 x 84	Static	O2TC1884T16	672	767	923	1,195	785
		Folding	O2TC1884T16FD	860	956	1,112	1,384	983
		Nesting	O2TC1884T18NE	1,268	1,362	1,515	NA	1,452
	18 x 90	Static	O2TC1890T16	705	815	974	1,243	785
		Folding	O2TC1890T16FD	894	1,003	1,163	1,432	983
		Nesting	O2TC1890T18NE	1,301	1,408	1,564	NA	1,452
	18 x 96	Static	O2TC1896T16	705	815	987	1,288	795
Folding		O2TC1896T16FD	894	1,003	1,176	1,477	993	
Nesting		O2TC1896T18NE	1,301	1,408	1,577	NA	1,462	
20 x 36	Static	O2TC2036T18	503	558	642	764	535	
	Nesting	O2TC2036T20NE	915	969	1,051	NA	986	
20 x 48	Static	O2TC2048T18	548	620	718	865	552	
	Folding	O2TC2048T18FD	792	865	962	1,109	809	
	Nesting	O2TC2048T20NE	985	1,056	1,151	NA	1,030	
20 x 60	Static	O2TC2060T18	568	649	767	961	637	
	Folding	O2TC2060T18FD	823	904	1,022	1,216	904	
	Nesting	O2TC2060T20NE	1,059	1,139	1,254	NA	1,170	
20 x 72	Static	O2TC2072T18	607	703	836	1,062	673	
	Folding	O2TC2072T18FD	861	957	1,091	1,317	941	
	Nesting	O2TC2072T20NE	1,269	1,363	1,494	NA	1,411	
20 x 84	Static	O2TC2084T18	747	873	1,010	1,228	860	
	Folding	O2TC2084T18FD	936	1,061	1,199	1,417	1,059	
	Nesting	O2TC2084T20NE	1,342	1,465	1,600	NA	1,526	
20 x 90	Static	O2TC2090T18	791	935	1,073	1,277	860	
	Folding	O2TC2090T18FD	980	1,124	1,261	1,465	1,059	
	Nesting	O2TC2090T20NE	1,385	1,526	1,661	NA	1,526	
20 x 96	Static	O2TC2096T18	791	935	1,086	1,325	881	
	Folding	O2TC2096T18FD	980	1,124	1,275	1,514	1,079	
	Nesting	O2TC2096T20NE	1,385	1,526	1,674	NA	1,546	

**tableXPRESS**  
 Select Fundamental rectangular tables are available on our 5-day quickship program. See page 204 for details.

Fundamental

- LC**  
+90
- CCG**  
+120
- OS**  
+35
- CH**  
+100
- WM**  
+125
- WMLC**  
+45
- SH**  
T+130
- FR**  
NA
- PB**  
NA
- GR**  
+40
- CM**  
+50
- RC**  
+55
- GN**  
+40
- LT**  
+115
- AH**  
T+250
- RA**  
T+365
- NU**  
T+700



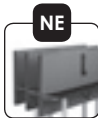



Top Size	Base	Model Number	3P	3K	3W	W1-W4	F1-F5	Rectangular with T-bases
24 x 36	Static	02TC2436T20	\$ 506	\$ 561	\$ 654	\$ 808	\$ 597	    <p>Folding T    Nesting T</p>
	Nesting	02TC2436T22NE	918	971	1,062	NA	1,047	
24 x 48	Static	02TC2448T20	551	623	729	912	614	
	Folding	02TC2448T20FD	795	868	974	1,157	871	
24 x 60	Nesting	02TC2448T22NE	987	1,059	1,163	NA	1,091	
	Static	02TC2460T20	571	652	779	1,020	676	
	Folding	02TC2460T20FD	826	907	1,033	1,275	944	
24 x 72	Nesting	02TC2460T22NE	1,062	1,141	1,266	NA	1,209	
	Static	02TC2472T20	609	706	848	1,124	708	
	Folding	02TC2472T20FD	864	960	1,102	1,379	976	
24 x 84	Nesting	02TC2472T22NE	1,271	1,366	1,505	NA	1,445	
	Static	02TC2484T20	750	875	1,022	1,298	936	
	Folding	02TC2484T20FD	938	1,064	1,211	1,487	1,135	
24 x 90	Nesting	02TC2484T22NE	1,344	1,468	1,611	NA	1,601	
	Static	02TC2490T20	794	938	1,084	1,350	947	
	Folding	02TC2490T20FD	983	1,126	1,273	1,539	1,145	
24 x 96	Nesting	02TC2490T22NE	1,388	1,529	1,672	NA	1,611	
	Static	02TC2496T20	794	938	1,098	1,402	957	
	Folding	02TC2496T20FD	983	1,126	1,286	1,591	1,155	
30 x 36	Nesting	02TC2496T22NE	1,388	1,529	1,686	NA	1,621	
	Static	02TC3036T26	542	610	706	870	643	
	Folding	02TC3036T26FD	841	931	1,038	1,234	910	
30 x 48	Nesting	02TC3036T26NE	953	1,019	1,114	NA	1,091	
	Static	02TC3048T26	597	687	793	989	653	
	Folding	02TC3048T26FD	841	931	1,038	1,234	910	
30 x 60	Nesting	02TC3048T26NE	1,033	1,121	1,225	NA	1,129	
	Static	02TC3060T26	614	711	839	1,105	807	
	Folding	02TC3060T26FD	868	965	1,094	1,359	1,075	
30 x 72	Nesting	02TC3060T26NE	1,104	1,199	1,325	NA	1,337	
	Static	02TC3072T26	657	771	913	1,220	880	
	Folding	02TC3072T26FD	911	1,025	1,168	1,475	1,148	
30 x 84	Nesting	02TC3072T26NE	1,318	1,430	1,569	NA	1,614	
	Static	02TC3084T26	827	983	1,121	1,401	960	
	Folding	02TC3084T26FD	1,016	1,172	1,310	1,590	1,158	
30 x 90	Nesting	02TC3084T26NE	1,420	1,573	1,708	NA	1,624	
	Static	02TC3090T26	882	1,060	1,195	1,461	980	
	Folding	02TC3090T26FD	1,071	1,249	1,384	1,649	1,178	
30 x 96	Nest/Lightwt	02TC3090T26NE-LT	1,584	NA	1,901	NA	NA	
	Static	02TC3096T26	882	1,060	1,208	1,516	990	
	Folding	02TC3096T26FD	1,071	1,249	1,397	1,705	1,189	
30 x 96	Nest/Lightwt	02TC3096T26NE-LT	1,584	NA	1,914	NA	NA	



**tableXPRESS**  
 Select Fundamental rectangular tables are available on our 5-day quickship program. See page 204 for details.

Fundamental



- LC**  
+90
- CCG**  
+120
- OS**  
+35
- CH**  
+100
- WM**  
+125
- WMLC**  
+45
- SH**  
T+130
- FR**  
NA
- PB**  
NA
- GR**  
+40
- CM**  
+50
- RC**  
+55
- GN**  
+40
- LT**  
+115
- AH**  
T+250
- RA**  
T+365
- NU**  
T+700

Rectangular with T-bases	Top Size	Base	Model Number	3P	3K	3W	W1-W4	F1-F5
  <div style="display: flex; align-items: center; margin-top: 20px;"> <div style="margin-right: 10px;">  <p>Folding T</p> </div> <div style="margin-right: 10px;">  <p>Nesting T</p> </div> <div style="border: 1px solid gray; padding: 5px; text-align: center;"> <p><b>tableXPRESS</b></p> <p>Select Fundamental rectangular tables are available on our 5-day quickship program. See page 204 for details.</p> </div> </div>	36 x 48	Static	02TC3648T26	\$ 640	\$ 747	\$ 854	\$ 1,060	\$ 701
	Folding	02TC3648T26FD	885	992	1,099	1,305	958	
	Nesting	02TC3648T26NE	1,229	1,335	1,439	NA	1,362	
	36 x 60	Static	02TC3660T26	706	839	953	1,186	901
	Folding	02TC3660T26FD	960	1,094	1,208	1,441	1,168	
	Nesting	02TC3660T26NE	1,347	1,478	1,590	NA	1,614	
	36 x 72	Static	02TC3672T26	747	897	1,026	1,313	1,018
	Folding	02TC3672T26FD	1,002	1,152	1,280	1,567	1,285	
	Nesting	02TC3672T26NE	1,406	1,553	1,679	NA	1,748	
	36 x 84	Static	02TC3684T26	903	1,089	1,217	1,505	1,107
	Folding	02TC3684T26FD	1,091	1,278	1,406	1,694	1,305	
	Nest/Lightwt	02TC3684T26NE-LT	1,604	NA	1,923	NA	NA	
36 x 90	Static	02TC3690T26	967	1,179	1,302	1,568	1,117	
Folding	02TC3690T26FD	1,156	1,368	1,490	1,757	1,316		
Nest/Lightwt	02TC3690T26NE-LT	1,667	NA	2,006	NA	NA		
36 x 96	Static	02TC3696T26	967	1,179	1,315	1,632	1,122	
Folding	02TC3696T26FD	1,156	1,368	1,504	1,820	1,321		
Nest/Lightwt	02TC3696T26NE-LT	1,667	NA	2,019	NA	NA		



Fundamental



Rectangular with TT-bases	Top Size	Base	Model Number	3P	3K	3W	W1-W4	F1-F5
  <div style="display: flex; align-items: center; margin-top: 20px;"> <div style="margin-right: 10px;">  <p>Nesting TT</p> </div> <div style="margin-right: 10px;"> <p><b>new</b></p> </div> </div>	42 x 60	Static	02TC4260TT34	\$ 931	\$ 1,088	\$ 1,198	\$ 1,433	1,068
	Nesting	02TC4260TT34NE	1,685	1,838	1,946	NA	1,900	
	42 x 72	Static	02TC4272TT34	1,009	1,197	1,311	1,571	1,195
	Nesting	02TC4272TT34NE	1,761	1,946	2,057	NA	2,025	
	42 x 84	Static	02TC4284TT34	1,150	1,368	1,486	1,774	1,284
	42 x 90	Static	02TC4290TT34	1,223	1,469	1,579	1,841	1,305
	42 x 96	Static	02TC4296TT34	1,223	1,469	1,592	1,912	1,315
	48 x 60	Static	02TC4860TT36	987	1,166	1,273	1,515	1,175
	Nesting	02TC4860TT36NE	1,685	1,838	1,960	NA	2,006	
	48 x 72	Static	02TC4872TT36	1,076	1,291	1,398	1,664	1,302
	Nesting	02TC4872TT36NE	1,761	1,946	2,070	NA	2,130	
	48 x 84	Static	02TC4884TT36	1,150	1,368	1,499	1,875	1,392
	48 x 90	Static	02TC4890TT36	1,224	1,471	1,594	1,949	1,433
	48 x 96	Static	02TC4896TT36	1,224	1,471	1,607	2,023	1,443

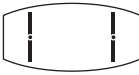

- LC**  
+90
- CCG**  
+120
- OS**  
+35
- CH**  
+100
- WM**  
+125
- WMLC**  
+45
- SH**  
T+130  
TT+260
- FR**  
NA
- PB**  
NA
- GR**  
+40
- CM**  
+50
- RC**  
+55
- GN**  
+40
- LT**  
+115
- AH**  
T+250
- RA**  
T+365
- NU**  
T+700

Top Size	Base	Model Number	3P	3K	3W	W1-W4	F1-F5	Rectangular with 3 TT-bases
42 x 120	Static	02TC42120TT34(3)	\$ 1,764	\$ 2,131	\$ 2,217	\$ 2,426	2,212	 
42 x 144	Static	02TC42144TT34(3)	1,914	2,341	2,436	2,697	2,232	
48 x 120	Static	02TC48120TT36(3)	1,773	2,143	2,241	2,560	2,263	
48 x 144	Static	02TC48144TT36(3)	1,925	2,356	2,461	2,850	2,314	

3 bases: **LC** **SH** **CH**  
+135 quote +150







Top Size	Base	Model Number	3P	3K	3W	W1-W4	F1-F5	Boat-Shaped with T-bases
30 x 42 x 84	Static	02BT3084T26	\$ 1,176	\$ 1,471	\$ 1,491	\$ 2,186	\$ 1,237	 
30 x 42 x 90	Static	02BT3090T26	1,281	1,618	1,619	2,283	1,262	
30 x 42 x 96	Static	02BT3096T26	1,281	1,618	1,633	2,376	1,274	

Top Size	Base	Model Number	3P	3K	3W	W1-W4	F1-F5	Boat-Shaped with TT-bases
36 x 48 x 84	Static	02BT3684TT34	\$ 1,448	\$ 1,785	\$ 1,781	\$ 2,492	\$ 1,427	 
36 x 48 x 90	Static	02BT3690TT34	1,567	1,952	1,925	2,593	1,477	
36 x 48 x 96	Static	02BT3696TT34	1,567	1,952	1,939	2,689	1,489	

Top Size	Base	Model Number	3P	3K	3W	W1-W4	F1-F5	Boat-Shaped with 3 TT-bases
36 x 48 x 120	Static	02BT36120TT36(3)	\$ 2,196	\$ 2,736	\$ 2,660	\$ 3,326	2,263	 
36 x 48 x 144	Static	02BT36144TT36(3)	2,435	3,069	2,976	3,724	2,314	

3 bases: **LC** **SH** **CH**  
+135 quote +150

- LC**  
+90
- CCG**  
+120
- OS**  
NA
- CH**  
+100
- WM**  
+125
- WMLC**  
+45
- SH**  
T+130  
TT+260
- FR**  
NA
- PB**  
NA
- GR**  
+40
- CM**  
+50
- RC**  
+55
- GN**  
+40
- LT**  
+115
- AH**  
T+250
- RA**  
T+365
- NU**  
T+700

Racetrack with T-bases	Top Size	Base	Model Number	3P	3K	3W	W1-W4	F1-F5
 	36 x 60	Static	O2RT3660T26	\$ 829	\$ 1,012	\$ 1,055	\$ 1,633	\$ 1,003
		Nesting	O2RT3660T26NE	1,415	1,594	1,636	NA	1,659
	36 x 72	Static	O2RT3672T26	917	1,135	1,178	1,808	1,143
		Folding	O2RT3672T26FD	1,171	1,389	1,433	2,062	1,411
		Nesting	O2RT3672T26NE	1,554	1,768	1,810	NA	1,852
	36 x 84	Static	O2RT3684T26	1,074	1,329	1,371	2,052	1,237
		Folding	O2RT3684T26FD	1,263	1,518	1,560	2,241	1,435
	36 x 90	Static	O2RT3690T26	1,192	1,494	1,514	2,141	1,249
		Folding	O2RT3690T26FD	1,381	1,683	1,703	2,330	1,448
	36 x 96	Static	O2RT3696T26	1,192	1,494	1,528	2,227	1,256
		Folding	O2RT3696T26FD	1,381	1,683	1,717	2,416	1,454







Folding T



Nesting T

**tableXPRESS**  
 Select Fundamental racetrack tables are available on our 5-day quickship program. See page 204 for details.

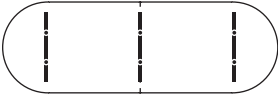
Racetrack with TT-bases	Top Size	Base	Model Number	3P	3K	3W	W1-W4	F1-F5
 	42 x 84	Static	O2RT4284TT34	\$ 1,342	\$ 1,636	\$ 1,657	\$ 2,355	\$ 1,414
		Static	O2RT4290TT34	1,449	1,786	1,788	2,451	1,439
		Static	O2RT4296TT34	1,449	1,786	1,801	2,544	1,451
		Static	O2RT4884TT34	1,567	1,952	1,912	2,492	1,427
		Static	O2RT4890TT34	1,567	1,952	1,925	2,593	1,476
		Static	O2RT4896TT34	1,567	1,952	1,939	2,689	1,488

Racetrack with 3 TT-bases	Top Size	Base	Model Number	3P	3K	3W	W1-W4	F1-F5
 	42 x 120	Static	O2RT42120TT34(3)	\$ 2,183	\$ 2,717	\$ 2,638	\$ 3,158	2,212
		Static	O2RT42144TT34(3)	2,419	3,048	2,951	3,534	2,232
		Static	O2RT48120TT36(3)	2,197	2,736	2,661	3,326	2,263
		Static	O2RT48144TT36(3)	2,435	3,070	2,976	3,724	2,314

3 bases: **LC** **SH** **CH**  
 +135 quote +150

Fundamental

- LC**  
+90
- CCG**  
+120
- OS**  
NA
- CH**  
+100
- WM**  
+125
- WMLC**  
+45
- SH**  
T+130  
TT+260
- FR**  
NA
- PB**  
NA
- GR**  
+40
- CM**  
+50
- RC**  
NA
- GN**  
NA
- LT**  
NA
- AH**  
T+250
- RA**  
T+365
- NU**  
T+700

Top Size	Base	Model Number	3P	3K	3W	W1-W4	F1-F5	Elliptical with T-bases
30 x 54	Static	02EL3054T22	\$ 713	\$ 851	\$ 895	\$ 1,433	\$ 781	
30 x 60	Static	02EL3060T22	750	902	945	1,515	804	
36 x 60	Static	02EL3660T26	829	1,012	1,043	1,633	901	
36 x 72	Static	02EL3672T26	917	1,135	1,161	1,808	1,018	
36 x 84	Static	02EL3684T26	1,074	1,329	1,348	2,052	1,107	
36 x 90	Static	02EL3690T26	1,192	1,494	1,488	2,141	1,152	
36 x 96	Static	02EL3696T26	1,192	1,494	1,499	2,227	1,176	

Top Size	Base	Model Number	3P	3K	3W	W1-W4	F1-F5	Elliptical with TT-bases
42 x 72	Static	02EL4272TT26	\$ 1,131	\$ 1,385	\$ 1,394	\$ 2,056	1,146	
42 x 84	Static	02EL4284TT26	1,296	1,590	1,590	2,308	1,236	
42 x 90	Static	02EL4290TT26	1,405	1,743	1,721	2,405	1,256	
42 x 96	Static	02EL4296TT26	1,405	1,743	1,731	2,498	1,266	
48 x 72	Static	02EL4872TT30	1,249	1,551	1,535	2,183	1,254	
48 x 84	Static	02EL4884TT30	1,326	1,633	1,634	2,446	1,343	
48 x 90	Static	02EL4890TT30	1,522	1,906	1,860	2,546	1,384	
48 x 96	Static	02EL4896TT30	1,522	1,906	1,870	2,643	1,395	

Top Size	Base	Model Number	3P	3K	3W	W1-W4	F1-F5	Elliptical with 3 TT-bases
42 x 120	Static	02EL42120TT34(3)	\$ 2,183	\$ 2,717	\$ 2,601	\$ 3,158	2,212	
42 x 144	Static	02EL42144TT34(3)	2,419	3,048	2,902	3,534	2,232	
48 x 120	Static	02EL48120TT36(3)	2,197	2,736	2,626	3,326	2,263	
48 x 144	Static	02EL48144TT36(3)	2,435	3,070	2,930	3,724	2,314	

3 bases: **LC** **SH** **CH**  
+135 quote +150

Square with X-base		Top Size	Base	Model Number	3P	3K	3W	W1-W4	F1-F5
<p>Flip Top X</p> <p>Select Fundamental square tables are available on our 5-day quickship program. See page 204 for details.</p>		24 x 24	Static	02SQ2424X22	\$ 387	\$ 424	\$ 503	\$ 629	\$ 431
			Flip Top	02SQ2424X22FT	509	546	625	751	559
		30 x 30	Static	02SQ3030X26	444	500	592	744	492
			Flip Top	02SQ3030X26FT	565	622	713	865	620
		36 x 36	Static	02SQ3636X32	524	605	705	883	658
			Flip Top	02SQ3636X32FT	646	727	827	1,005	786
		42 x 42	Static	02SQ4242X36	603	713	818	1,022	687
			Flip Top	02SQ4242X36FT	725	834	940	1,143	815
		48 x 48	Static	02SQ4848X38	700	842	949	1,174	724

Square with disc base		Top Size	Base	Model Number	3P	3K	3W	W1-W4	F1-F5
<p>new</p> <p>Counterbalanced &amp; Short Balanced Height Adj.</p> <p>disc base: <b>CH</b> +400   <b>SH</b> +65</p>		24 x 24	Static	44SQ2424D20	\$ 688	\$ 727	\$ 809	\$ 939	\$ 748
			Short Bal	44SQ2424D20BLS	1,086	1,124	1,206	1,336	1,166
		30 x 30	Static	44SQ3030D24	779	838	933	1,090	846
			Short Bal	44SQ3030D24BLS	1,386	1,445	1,540	1,697	1,484
		36 x 36	Static	44SQ3636D24	842	926	1,029	1,213	996
			Short Bal	44SQ3636D24BLS	1,449	1,533	1,636	1,820	1,633
			Count Bal	44SQ3636D24BL	1,449	1,533	1,636	1,820	1,633
		42 x 42	Static	44SQ4242D32	1,042	1,155	1,264	1,475	1,150
			Short Bal	44SQ4242D32BLS	1,638	1,751	1,860	2,070	1,775
			Count Bal	44SQ4242D32BL	1,638	1,751	1,860	2,070	1,775

Square with 4-column X-base		Top Size	Base	Model Number	3P	3K	3W	W1-W4	F1-F5
<p>X.4 bases: <b>SH</b> +260   <b>CH</b> NA</p>		54 x 54	Static	02SQ5454X36.4	\$ 974	\$ 1,153	\$ 1,260	\$ 1,505	NA
		60 x 60	Static	02SQ6060X42.4	1,174	1,394	1,497	1,762	NA

Square with TT-bases		Top Size	Base	Model Number	3P	3K	3W	W1-W4	F1-F5
<p>Nesting TT</p>		48 x 48	Static	02SQ4848TT34	\$ 896	\$ 1,038	\$ 1,145	\$ 1,370	\$ 929
			Nesting	02SQ4848TT34NE	1,650	1,789	1,895	NA	1,764

- LC**  
+90
- CCG**  
NA
- OS**  
NA
- CH**  
+100
- WM**  
+125
- WMLC**  
+45
- SH**  
X+65  
TT+260
- FR**  
+150
- PB**  
+90
- GR**  
+40
- CM**  
+50
- RC**  
+55
- GN**  
+40
- LT**  
+115
- AH**  
X+125
- RA**  
NA
- NU**  
X+350

Top Size	Base	Model Number	3P	3K	3W	W1-W4	F1-F5	Round with X-base		
24 x 24	Static	02RD24X22	\$ 418	\$ 467	\$ 514	\$ 830	\$ 431	 <table border="1"> <tr> <td>tableXPRESS</td> </tr> <tr> <td>Select Fundamental square tables are available on our 5-day quickship program. See page 204 for details.</td> </tr> </table>	tableXPRESS	Select Fundamental square tables are available on our 5-day quickship program. See page 204 for details.
	tableXPRESS									
Select Fundamental square tables are available on our 5-day quickship program. See page 204 for details.										
Flip Top	02RD24X22FT	539	589	636	952	559				
30 x 30	Static	02RD30X26	492	568	616	1,012	492			
	Flip Top	02RD30X26FT	614	690	738	1,133	620			
36 x 36	Static	02RD36X30	578	683	731	1,220	653			
	Flip Top	02RD36X30FT	700	805	852	1,342	780			
42 x 42	Static	02RD42X32	678	821	861	1,437	679			
	Flip Top	02RD42X32FT	800	942	983	1,559	807			
48 x 48	Static	02RD48X36	713	866	919	1,676	708			



Flip Top X

tableXPRESS

Select Fundamental square tables are available on our 5-day quickship program. See page 204 for details.

Top Size	Base	Model Number	3P	3K	3W	W1-W4	F1-F5	Round with disc base				
24 x 24	Static	44RD24D20	\$ 720	\$ 771	\$ 820	\$ 1,146	\$ 748	 <table border="1"> <tr> <td>disc base: CH SH</td> </tr> <tr> <td>+400 +65</td> </tr> </table> <table border="1"> <tr> <td>BL•BLS</td> </tr> <tr> <td>Counterbalanced &amp; Short Balanced Height Adj.</td> </tr> </table>	disc base: CH SH	+400 +65	BL•BLS	Counterbalanced & Short Balanced Height Adj.
	disc base: CH SH											
+400 +65												
BL•BLS												
Counterbalanced & Short Balanced Height Adj.												
Short Bal	44RD24D20BLS	1,118	1,169	1,218	1,544	1,166						
30 x 30	Static	44RD30D20	790	869	918	1,327	804					
	Short Bal	44RD30D20BLS	1,188	1,267	1,316	1,725	1,222					
36 x 36	Static	44RD36D20	863	972	1,021	1,527	954					
	Short Bal	44RD36D20BLS	1,261	1,370	1,419	1,925	1,372					
	Count Bal	44RD36D20BL	1,261	1,370	1,419	1,925	1,372					
42 x 42	Static	44RD42D24	1,001	1,148	1,190	1,787	1,017					
	Short Bal	44RD42D24BLS	1,608	1,755	1,797	2,394	1,654					
	Count Bal	44RD42D24BL	1,608	1,755	1,797	2,394	1,654					
48 x 48	Static	44RD48D32	1,155	1,314	1,369	2,152	1,171					
	Short Bal	44RD48D32BLS	1,751	1,909	1,964	2,747	1,796					
	Count Bal	44RD48D32BL	1,751	1,909	1,964	2,747	1,796					

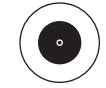

Counterbalanced & Short Balanced Height Adj.

disc base: CH SH  
+400 +65

new  
Fundamental

Top Size	Base	Model Number	3P	3K	3W	W1-W4	F1-F5	Round with 4-column X-base		
54 x 54	Static	02RD54X32.4	1,019	1,234	1,262	2,081	NA	 <table border="1"> <tr> <td>X.4 bases: SH CH</td> </tr> <tr> <td>+260 NA</td> </tr> </table>	X.4 bases: SH CH	+260 NA
X.4 bases: SH CH										
+260 NA										
60 x 60	Static	02RD60X36.4	1,085	1,309	1,352	2,394	NA			



X.4 bases: SH CH  
+260 NA

Top Size	Base	Model Number	3P	3K	3W	W1-W4	F1-F5	Round with TT-base				
48 x 48	Static	02RD48TT26	\$ 877	\$ 1,030	\$ 1,084	\$ 1,841	\$ 881	 <table border="1"> <tr> <td>FD</td> <td>NE</td> </tr> <tr> <td>Folding TT</td> <td>Nesting TT</td> </tr> </table>	FD	NE	Folding TT	Nesting TT
	FD	NE										
Folding TT	Nesting TT											
Nesting	02RD48TT26NE	1,632	1,782	1,834	NA	1,717						
54 x 54	Static	02RD54TT30	1,031	1,246	1,274	2,094	NA					
	Nesting	02RD54TT30NE	1,783	1,993	2,021	NA	NA					
60 x 60	Static	02RD60TT34	1,099	1,322	1,365	2,408	NA					
	Folding	02RD60TT34FD	1,662	1,885	1,928	NA	NA					
	Nesting	02RD60TT34NE	1,849	2,068	2,110	NA	NA					

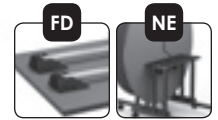
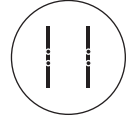

Folding TT Nesting TT

- LC**  
+90
- CCG**  
NA
- OS**  
NA
- CH**  
+100
- WM**  
+125
- WMLC**  
+45
- SH**  
X+65  
TT+260
- FR**  
+150
- PB**  
+90
- GR**  
+40
- CM**  
+50
- RC**  
NA
- GN**  
NA
- LT**  
+115
- AH**  
X+125
- RA**  
NA
- NU**  
X+350

D-shaped with T-bases	Top Size	Base	Model Number	3P	3K	3W	W1-W4	F1-F5
	24 x 36	Static	02D2436T20	\$ 550	\$ 623	\$ 691	\$ 972	\$ 596
		Nesting	02D2436T20NE	961	1,032	1,099	NA	1,046
	24 x 48	Static	02D2448T20	611	707	784	1,102	667
		Nesting	02D2448T20NE	1,020	1,115	1,190	NA	1,115
	24 x 60	Static	02D2460T20	671	792	877	1,232	737
		Nesting	02D2460T20NE	1,106	1,224	1,308	NA	1,212
	24 x 72	Static	02D2472T20	732	877	971	1,362	808
		Nesting	02D2472T20NE	1,256	1,398	1,490	NA	1,400
	24 x 84	Static	02D2484T20	858	1,027	1,130	1,558	947
		Nesting	02D2484T20NE	1,450	1,616	1,717	NA	1,612
	24 x 90	Static	02D2490T20	888	1,069	1,176	1,625	983
		Nesting	02D2490T20NE	1,480	1,658	1,763	NA	1,646
	24 x 96	Static	02D2496T20	918	1,111	1,223	1,692	1,018
		Nesting	02D2496T20NE	1,510	1,699	1,808	NA	1,681
	30 x 48	Static	02D3048T26	674	795	864	1,198	740
		Nesting	02D3048T26NE	1,082	1,201	1,268	NA	1,187
	30 x 60	Static	02D3060T26	749	900	974	1,339	807
		Nesting	02D3060T26NE	1,182	1,331	1,402	NA	1,280
	30 x 72	Static	02D3072T26	825	1,006	1,083	1,480	916
		Nesting	02D3072T26NE	1,347	1,525	1,601	NA	1,507
	30 x 84	Static	02D3084T26	966	1,178	1,259	1,687	1,074
		Nesting	02D3084T26NE	1,557	1,764	1,844	NA	1,735
	30 x 90	Static	02D3090T26	1,004	1,231	1,314	1,758	1,118
		Nest/Lightwt	02D3090T26NE-LT	1,667	NA	NA	NA	NA
	30 x 96	Static	02D3096T26	1,042	1,283	1,369	1,829	1,162
		Nest/Lightwt	02D3096T26NE-LT	1,740	NA	NA	NA	NA
	36 x 48	Static	02D3648T26	734	879	941	1,291	811
		Nesting	02D3648T26NE	1,141	1,283	1,344	NA	1,256
	36 x 60	Static	02D3660T26	825	1,006	1,067	1,443	916
		Nesting	02D3660T26NE	1,374	1,552	1,612	NA	1,511
	36 x 72	Static	02D3672T26	915	1,133	1,194	1,592	1,018
		Nesting	02D3672T26NE	1,552	1,766	1,825	NA	1,728
	36 x 84	Static	02D3684T26	1,072	1,326	1,386	1,810	1,107
		Nest/Lightwt	02D3684T26NE-LT	1,770	NA	NA	NA	NA
	36 x 90	Static	02D3690T26	1,117	1,389	1,449	1,888	1,256
		Nest/Lightwt	02D3690T26NE-LT	1,814	NA	NA	NA	NA
	36 x 96	Static	02D3696T26	1,162	1,452	1,512	1,963	1,266
		Nest/Lightwt	02D3696T26NE-LT	1,859	NA	NA	NA	NA







NEW

Fundamental

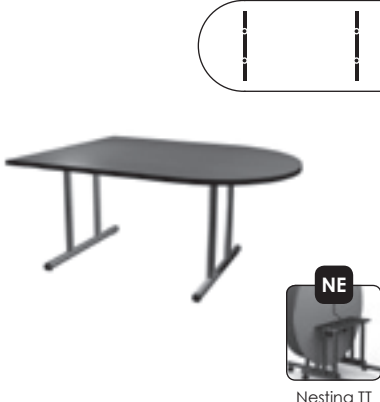
- LC**  
+90
- CCG**  
+120
- OS**  
+35
- CH**  
+100
- WM**  
+125
- WMLC**  
+45
- SH**  
T+130
- FR**  
NA
- PB**  
NA
- GR**  
+40
- CM**  
+50
- RC**  
+55
- GN**  
+40
- LT**  
+115
- AH**  
T+250
- RA**  
T+365
- NU**  
T+700





Top Size	Base	Model Number	3P	3K	3W	W1-W4	F1-F5	D-shaped with TT-bases	
42 x 60	Static	02D4260TT34	\$ 1,069	\$ 1,280	\$ 1,329	\$ 1,712	\$ 1,182		
	Nesting	02D4260TT34NE	1,820	2,027	2,075	NA	2,012		
42 x 72	Static	02D4272TT34	1,175	1,428	1,472	1,876	1,195		
	Nesting	02D4272TT34NE	1,924	2,172	2,216	NA	2,025		
42 x 84	Static	02D4284TT34	1,443	1,778	1,788	2,102	1,284		
42 x 90	Static	02D4290TT34	1,503	1,862	1,868	2,183	1,305		
42 x 96	Static	02D4296TT34	1,563	1,946	1,947	2,265	1,443		
48 x 60	Static	02D4860TT36	1,144	1,386	1,423	1,816	1,270		
	Nesting	02D4860TT36NE	1,894	2,131	2,167	NA	2,098		
48 x 72	Static	02D4872TT36	1,265	1,555	1,583	1,987	1,302		
	Nesting	02D4872TT36NE	2,012	2,297	2,324	NA	2,130		
48 x 84	Static	02D4884TT36	1,452	1,790	1,808	2,228	1,392		
48 x 90	Static	02D4890TT36	1,512	1,875	1,888	2,399	1,433		
48 x 96	Static	02D4896TT36	1,573	1,959	1,968	2,399	1,443		



Top Size	Base	Model Number	3P	3K	3W	W1-W4	F1-F5	D-shaped with 4-column X-base
54 x 54	Static	02D5454X36.4	\$ 1,274	\$ 1,573	\$ 1,578	\$ 1,818	\$ NA	
60 x 60	Static	02D6060X42.4	1,379	1,681	1,694	2,108	NA	



X.4 bases: **SH** **CH**  
+260 NA

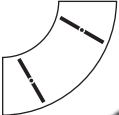

Fundamental

- LC**  
+90
- CCG**  
+120
- OS**  
+35
- CH**  
+100
- WM**  
+125
- WMLC**  
+45
- SH**  
TT+260
- FR**  
NA
- PB**  
NA
- GR**  
+40
- CM**  
+50
- RC**  
+55
- GN**  
+40
- LT**  
+115
- AH**  
NA
- RA**  
NA
- NU**  
NA

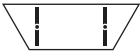
Half Round with T-bases	Top Size	Base	Model Number	3P	3K	3W	W1-W4	F1-F5
   Nesting T	18 x 36	Static	02HR1836T16	\$ 556	\$ 632	\$ 678	\$ 1,114	\$ 540
	24 x 48	Static	02HR2448T16	611	709	773	1,404	664
		Nesting	02HR2448T16NE	1,020	1,116	1,179	NA	1,112
	30 x 60	Static	02HR3060T20	748	900	958	1,716	825
		Nesting	02HR3060T22NE	1,155	1,303	1,361	NA	1,271
	36 x 72	Static	02HR3672T26	914	1,131	1,175	2,053	1,022
Nesting		02HR3672T26NE	1,498	1,711	1,754	NA	1,614	

Crescent with T-bases	Top Size	Base	Model Number	3P	3K	3W	W1-W4	F1-F5
 	24 x 48 x 75	Static	02CS2475T22	\$ 1,137	\$ 1,445	\$ 1,394	\$ 1,719	\$ 1,489
	24 x 60 x 94	Static	02CS2494T22	1,450	1,882	1,785	1,987	1,489
	30 x 60 x 94	Static	02CS3094T26	1,452	1,885	1,785	2,142	1,492

Trapezoid with T-bases	Top Size	Base	Model Number	3P	3K	3W	W1-W4	F1-F5
   Nesting T	24 x 48	Static	02TZ2448T18	\$ 603	\$ 697	\$ 760	\$ 1,192	\$ 664
	24 x 72	Static	02TZ2472T18	756	912	983	1,519	805
		Nesting	02TZ2472T18NE	1,189	1,342	1,411	NA	1,278
	30 x 60	Static	02TZ3060T22	708	843	909	1,492	825
		Nesting	02TZ3060T22NE	1,116	1,248	1,313	NA	1,271
	36 x 72	Static	02TZ3672T26	893	1,101	1,146	1,826	1,022
Nesting		02TZ3672T26NE	1,451	1,655	1,699	NA	1,649	

Corner with T-bases	Top Size	Base	Model Number	3P	3K	3W	W1-W4	F1-F5
 	24 x 42	Static	02CR2442T30	\$ 805	\$ 968	\$ 1,025	\$ 1,660	663
	30 x 48	Static	02CR3048T36	910	1,085	1,160	1,997	846

- LC**  
+90
- CCG**  
+120
- OS**  
+35
- CH**  
+100
- WM**  
+125
- WMLC**  
+45
- SH**  
T+130
- FR**  
NA
- PB**  
NA
- GR**  
+40
- CM**  
+50
- RC**  
+55
- GN**  
+40
- LT**  
NA
- AH**  
T+250
- RA**  
T+365
- NU**  
T+700

Fundamental

Top Size	Base	Model Number	3P	3K	3W	W1-W4	F1-F5	Arc Segment with T-bases
20 x 44	Static	02AS2044T18	\$ 635	\$ 742	\$ 773	NA	\$ 597	
24 x 51	Static	02AS2451T20	705	839	866	NA	690	
30 x 59	Static	02AS3059T26	774	935	966	NA	828	
36 x 67	Static	02AS3667T26	935	1,161	1,183	NA	1,022	

Top Size	Base	Model Number	3P	3K	3W	W1-W4	F1-F5	Ganging Quarter Round (with T-base)
20 x 20	Ganging	QR2020GN	\$ 224	\$ 272	\$ 319	NA	\$ 236	
24 x 24	Ganging	QR2424GN	233	284	344	NA	236	
30 x 30	Static, GN	02QR3030GNT20	448	524	586	NA	447	
	Ganging	QR3030GN	301	380	444	NA	292	
36 x 36	Static, GN	02QR3636GNT20	510	610	678	NA	591	
	Ganging	QR3636GN	365	469	540	NA	442	

1 base: **LC** NA **CCG** NA **OS** +18 **CH** +50 **SH** +65

**GN**  
Ganging included

Top Size	Base	Model Number	3P	3K	3W	W1-W4	F1-F5	Ganging 45° Wedge (with T-base)
20 x 20	Ganging	WG45D20GN	\$ 224	\$ 272	\$ 315	NA	\$ 236	
24 x 24	Ganging	WG45D24GN	233	284	337	NA	236	
30 x 30	Ganging	WG45D30GN	301	380	432	NA	292	
36 x 36	Static, GN	02WG45D36GNT20	510	610	660	NA	591	
	Ganging	WG45D36GN	365	469	520	NA	442	

1 base: **LC** NA **CCG** NA **OS** +18 **CH** +50 **SH** +65



**GN**  
Ganging included



Top Size	Base	Model Number	3P	3K	3W	W1-W4	F1-F5	Ganging 60° Wedge (with T-base)
20 x 20	Ganging	WG60D20GN	\$ 246	\$ 302	\$ 343	NA	\$ 236	
24 x 24	Ganging	WG60D24GN	254	314	366	NA	236	
30 x 30	Static, GN	02WG60D30GNT20	468	553	603	NA	447	
	Ganging	WG60D30GN	322	410	462	NA	292	
36 x 36	Static, GN	02WG60D36GNT20	530	639	691	NA	591	
	Ganging	WG30D36GN	386	499	553	NA	442	



1 base: **LC** NA **CCG** NA **OS** +18 **CH** +50 **SH** +65

**GN**  
Ganging included



- LC**  
+90
- CCG**  
+120
- OS**  
+35
- CH**  
+100
- WM**  
+125
- WMLC**  
+45
- SH**  
T+130
- FR**  
NA
- PB**  
NA
- GR**  
+40
- CM**  
+50
- RC**  
+55
- GN**  
+40
- LT**  
NA
- AH**  
T+250
- RA**  
T+365
- NU**  
T+700

Video Wedge with T-bases	Top Size	Base	Model Number	3P	3K	3W	W1-W4	F1-F5
 	20 x 20 x 40	Static	02VW2040T18	\$ 593	\$ 684	\$ 742	NA	\$ 578
	24 x 24 x 48	Static	02VW2448T20	637	745	815	NA	667
	30 x 30 x 60	Static	02VW3060T26	774	935	1,003	NA	828
	36 x 36 x 72	Static	02VW3672T26	1,016	1,274	1,307	NA	1,022

10° Transition with T-bases	Top Size	Base	Model Number	3P	3K	3W	W1-W4	F1-F5
 	20 x 30	Static	02TN2030T18	\$ 501	\$ 554	\$ 618	NA	\$ 529
	24 x 30	Static	02TN2430T20	514	571	640	NA	561
	30 x 30	Static	02TN3030T26	570	649	713	NA	608
	36 x 30	Static	02TN3630T26	632	736	792	NA	652



Trident with 3 Offset T-bases	Top Size	Base	Model Number	3P	3K	3W	W1-W4	F1-F5
 	36 x 36 x 18	Static	02TR3618TOS16(3)	\$ 1,039	\$ 1,225	\$ 1,209	\$ 1,553	\$ 930
	40 x 40 x 20	Static	02TR4020TOS16(3)	1,141	1,368	1,335	1,672	1,186
	48 x 48 x 24	Static	02TR4824TOS16(3)	1,154	1,385	1,376	1,936	1,186
	60 x 60 x 30	Static	02TR6030TOS16(3)	1,335	1,639	1,617	2,356	NA



3 bases: **LC** **SH** **CH**  
 +135 +195 +150

Quadrant with 4-Column X-base	Top Size	Base	Model Number	3P	3K	3W	W1-W4	F1-F5
 	60 x 60 x 18	Static	02QD6028X36.4	\$ 1,329	\$ 1,650	\$ 1,637	\$ 2,461	NA
	60 x 60 x 20	Static	02QD6020X36.4	1,329	1,650	1,638	2,461	NA
	60 x 60 x 24	Static	02QD6024X36.4	1,329	1,650	1,642	2,461	NA
	60 x 60 x 30	Static	02QD6030X36.4	1,329	1,650	1,648	2,461	NA

X.4 bases: **SH** **CH**  
 +260 NA



- LC**  
+90
- CCG**  
+120
- OS**  
+35
- CH**  
+100
- WM**  
+125
- WMLC**  
+45
- SH**  
T+130
- FR**  
NA
- PB**  
NA
- GR**  
+40
- CM**  
+50
- RC**  
+55
- GN**  
+40
- LT**  
NA
- AH**  
T+250
- RA**  
T+365
- NU**  
T+700



Top Size	Base	Model Number	3P	3K	3W	W1-W4	F1-F5	Bulb with X-base
24 x 24 x 18	Static	02BU2418X22	\$ 611	\$ 738	\$ 731	\$ 1,183	\$ 447	 
30 x 30 x 20	Static	02BU3020X26	655	797	801	1,439	534	
36 x 36 x 24	Static	02BU3624X30	772	955	950	1,711	646	
42 x 42 x 30	Static	02BU4230X32	871	1,091	1,081	1,992	767	
48 x 48 x 36	Static	02BU4836X36	892	1,117	1,125	2,279	907	

Top Size	Base	Model Number	3P	3K	3W	W1-W4	F1-F5	Squiracle with X-base
24 x 24	Static	02SL24X22	\$ 566	\$ 674	\$ 700	\$ NA	\$ 431	 
	Flip Top	02SL24X22FT	687	796	822	NA	559	
30 x 30	Static	02SL30X26	620	747	785	NA	492	
	Flip Top	02SL30X26FT	741	869	907	NA	620	
36 x 36	Static	02SL36X32	692	840	890	NA	658	
	Flip Top	02SL36X32FT	814	962	1,012	NA	786	
42 x 42	Static	02SL42X36	758	929	988	NA	687	
	Flip Top	02SL42X36FT	879	1,050	1,109	NA	815	
48 x 48	Static	02SL48X38	841	1,039	1,105	NA	724	

NEW

Fundamental

Top Size	Base	Model Number	3P	3K	3W	W1-W4	F1-F5	Teardrop with X-base
24 x 48	Static	02TE2448X3236	\$ 770	\$ 933	\$ 990	NA	663	 

Top Size	Base	Model Number	3P	3K	3W	W1-W4	F1-F5	Table Desk with T-bases
37 x 60	Static	02TA3760T26	\$ 819	\$ 998	\$ 1,102	\$ 1,770	\$ 931	 
42 x 78	Static	02TA4278T30	1,158	1,436	1,522	2,273	1,349	

- LC**  
+90
- CCG**  
+120
- OS**  
+35
- CH**  
+100
- WM**  
+125
- WMLC**  
+45
- SH**  
X+65  
T+130
- FR**  
NA
- PB**  
+90
- GR**  
+40
- CM**  
+50
- RC**  
+55
- GN**  
+40
- LT**  
NA
- AH**  
X+125  
T+250
- RA**  
T+365
- NU**  
X+350  
T+700



The smoothly curved and sleek look of Stretch makes it a great option for classrooms and training rooms. Its tubular construction gives it strength and a contemporary design aesthetic.

## Stretch Base Styles



## Stretch Base Options



standard glides

locking casters

- LC Locking Casters**  
can be added to any table for \$90.
- CH Chrome Finish**  
available for \$100 on most models.
- SH Special Height**  
of can be added to any table:  
+ \$65 per column for heights > 29"  
+ \$35 per column for heights < 29"  
Special height tables larger than 36x72" must be custom quoted.
- FD Folding Bases**  
priced accordingly with standard glides.
- WM Wire Management**  
Built in wire management is available on one leg for \$125.
- FR Footring**  
is not available on the Stretch series.
- NE Nesting Tables**  
priced accordingly with locking casters.
- WMLC Wire Management Leg Covers**  
snap onto any leg and are \$45 each.
- FT Flip Tops**  
available on X-based tables and are priced with standard glides.
- PB Power Box Mounting Plate**  
is available on X-bases for \$90.
- OS Offset Bases**  
available for \$35.

Stretch

## Stretch Height Adjustable Options

**AH Spring Clip**  
is available on X-bases for \$125 and on T-bases for \$250 per table.

**NU Pneumatic**  
is not available on Stretch bases.

**RA Ratchet**  
is not available on Stretch bases.

**BL Counterbalanced**  
is not available on Stretch bases.

## Stretch Top Shapes

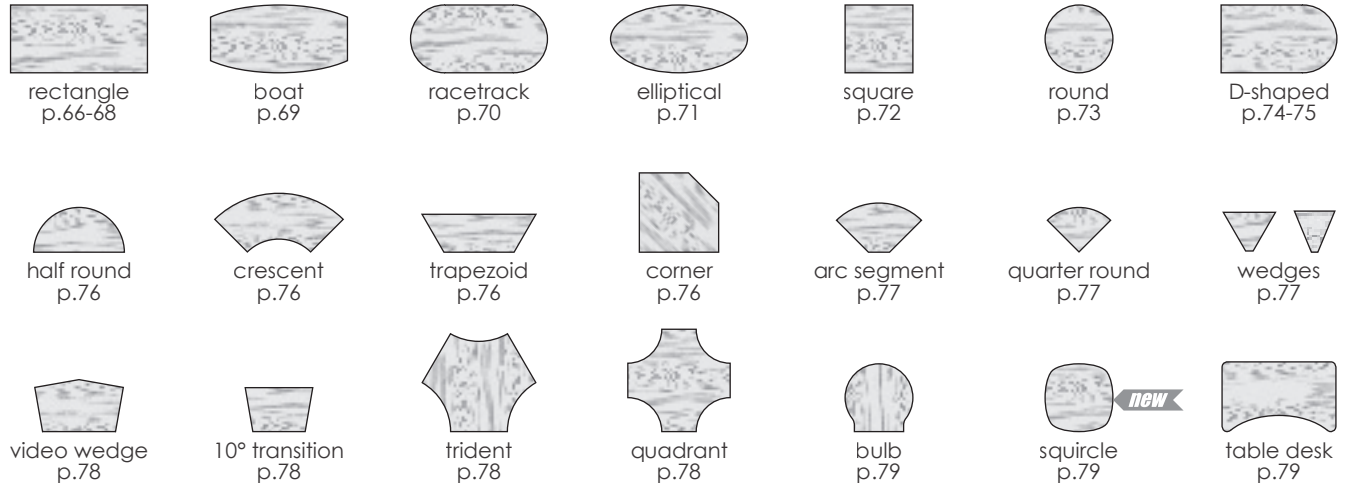

## Stretch Top Options

**RC 3" Radius Corners**  
can be added to any table for \$55.

**GN Ganging Brackets**  
can be added to most table shapes for \$40.

**LT Lightweight Tops**  
can be added to any square or rectangular table for \$115. This is a great option when specifying folding tables.

**GR Grommets**  
can be added to any table for \$40 each. To see specific locations, see page 203.

**CM Cable Manager**  
can be added to any table for \$50 each. To see specific locations, see page 203.

## Stretch Edge Options

(correspond with 5 columns of pricing)

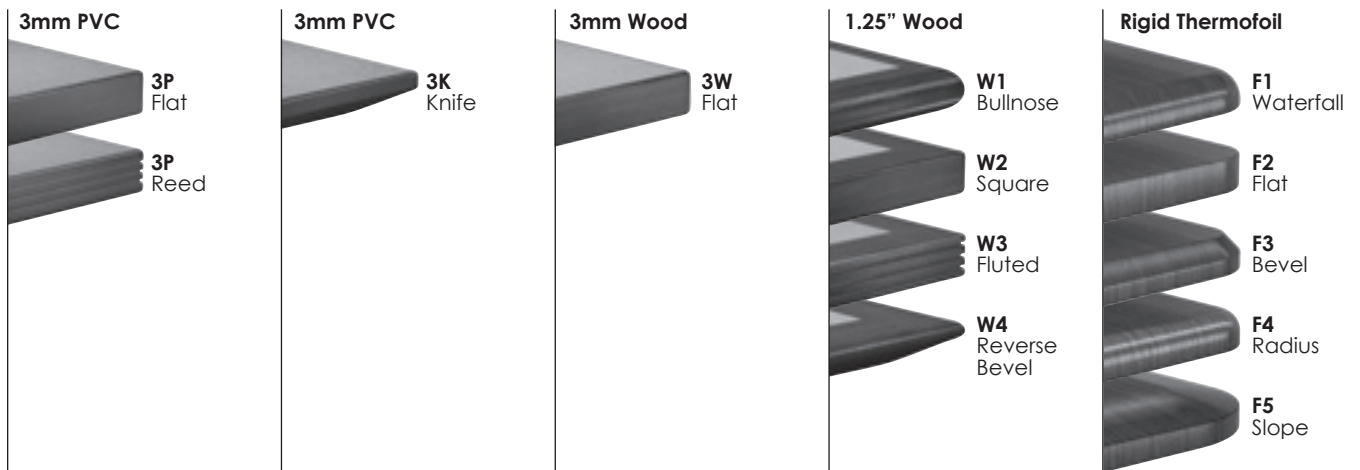







Rectangular with T-bases	Top Size	Base	Model Number	3P	3K	3W	W1-W4	F1-F5
  <div style="display: flex; justify-content: space-around; margin-top: 10px;"> <div style="text-align: center;">  <p>FD Folding T</p> </div> <div style="text-align: center;">  <p>NE Nesting T</p> </div> </div>	20 x 36	Static	06TC2036T18	\$ 542	\$ 599	\$ 686	\$ 812	\$ 576
		Nesting	06TC2036T18NE	968	1,023	1,108	NA	1,042
	20 x 48	Static	06TC2048T18	588	663	764	916	594
		Folding	06TC2048T18FD	841	916	1,017	1,169	860
		Nesting	06TC2048T18NE	1,040	1,113	1,212	NA	1,088
	20 x 60	Static	06TC2060T18	609	693	815	1,016	681
		Folding	06TC2060T18FD	873	956	1,078	1,279	958
		Nesting	06TC2060T18NE	1,117	1,199	1,318	NA	1,233
	20 x 72	Static	06TC2072T18	649	748	886	1,120	719
		Folding	06TC2072T18FD	912	1,012	1,150	1,383	996
		Nesting	06TC2072T18NE	1,333	1,431	1,566	NA	1,481
	20 x 84	Static	06TC2084T18	794	924	1,067	1,292	913
		Folding	06TC2084T18FD	989	1,119	1,262	1,487	1,118
		Nesting	06TC2084T18NE	1,409	1,536	1,676	NA	1,601
	20 x 90	Static	06TC2090T18	840	988	1,131	1,342	913
		Folding	06TC2090T18FD	1,035	1,184	1,326	1,537	1,118
		Nesting	06TC2090T18NE	1,454	1,599	1,739	NA	1,601
	20 x 96	Static	06TC2096T18	840	988	1,145	1,392	934
	Folding	06TC2096T18FD	1,035	1,184	1,340	1,587	1,139	
	Nesting	06TC2096T18NE	1,454	1,599	1,753	NA	1,622	
24 x 36	Static	06TC2436T22	526	583	679	838	620	
	Nesting	06TC2436T22NE	952	1,007	1,101	NA	1,085	
24 x 48	Static	06TC2448T22	572	647	757	946	638	
	Folding	06TC2448T22FD	825	900	1,010	1,199	903	
	Nesting	06TC2448T22NE	1,024	1,097	1,205	NA	1,131	
24 x 60	Static	06TC2460T22	593	677	808	1,057	702	
	Folding	06TC2460T22FD	856	940	1,071	1,321	978	
	Nesting	06TC2460T22NE	1,101	1,183	1,311	NA	1,253	
24 x 72	Static	06TC2472T22	633	732	879	1,165	735	
	Folding	06TC2472T22FD	896	996	1,143	1,429	1,012	
	Nesting	06TC2472T22NE	1,317	1,415	1,559	NA	1,497	
24 x 84	Static	06TC2484T22	778	908	1,060	1,345	971	
	Folding	06TC2484T22FD	973	1,103	1,255	1,540	1,176	
	Nesting	06TC2484T22NE	1,393	1,520	1,669	NA	1,658	
24 x 90	Static	06TC2490T22	824	972	1,124	1,399	982	
	Folding	06TC2490T22FD	1,019	1,167	1,319	1,594	1,187	
	Nesting	06TC2490T22NE	1,438	1,583	1,732	NA	1,669	
24 x 96	Static	06TC2496T22	824	972	1,138	1,453	992	
	Folding	06TC2496T22FD	1,019	1,167	1,333	1,648	1,197	
	Nesting	06TC2496T22NE	1,454	1,599	1,762	NA	1,696	

Stretch



- LC  
+90
- OS  
+35
- CH  
+100
- WM  
+125
- WMLC  
+45
- SH  
T+130
- FR  
NA
- PB  
NA
- GR  
+40
- CM  
+50
- RC  
+55
- GN  
+40
- LT  
+115
- AH  
T+250
- NU  
NA





Top Size	Base	Model Number	3P	3K	3W	W1-W4	F1-F5	Rectangular with T-bases
30 x 36	Static	06TC3036T26	\$ 579	\$ 649	\$ 749	\$ 919	\$ 684	   <b>FD</b>  <b>NE</b> Folding T      Nesting T
	Nesting	06TC3036T26NE	1,004	1,073	1,170	NA	1,148	
30 x 48	Static	06TC3048T26	636	729	839	1,042	695	
	Folding	06TC3048T26FD	889	982	1,092	1,295	961	
30 x 60	Nesting	06TC3048T26NE	1,087	1,178	1,286	NA	1,187	
	Static	06TC3060T26	654	754	886	1,161	855	
	Folding	06TC3060T26FD	917	1,017	1,150	1,425	1,131	
30 x 72	Nesting	06TC3060T26NE	1,160	1,258	1,388	NA	1,403	
	Static	06TC3072T26	698	816	963	1,281	930	
30 x 84	Folding	06TC3072T26FD	961	1,079	1,226	1,544	1,207	
	Nesting	06TC3072T26NE	1,381	1,497	1,641	NA	1,688	
	Static	06TC3084T26	874	1,036	1,178	1,468	1,012	
30 x 90	Folding	06TC3084T26FD	1,070	1,231	1,373	1,663	1,217	
	Nesting	06TC3084T26NE	1,488	1,646	1,785	NA	1,699	
	Static	06TC3090T26	932	1,116	1,255	1,530	1,033	
30 x 96	Folding	06TC3090T26FD	1,127	1,311	1,450	1,725	1,238	
	Nest/Lightwt	01TC3090T26NE-LT	1,657	NA	1,985	NA	NA	
	Static	06TC3096T26	932	1,116	1,268	1,587	1,044	
36 x 48	Folding	06TC3096T26FD	1,127	1,311	1,464	1,783	1,249	
	Nest/Lightwt	06TC3096T26NE-LT	1,657	NA	1,999	NA	NA	
	Static	06TC3648T26	681	792	902	1,115	745	
36 x 60	Folding	06TC3648T26FD	934	1,045	1,156	1,368	1,010	
	Nesting	06TC3648T26NE	1,290	1,399	1,507	NA	1,428	
	Static	06TC3660T26	749	887	1,005	1,246	951	
36 x 72	Folding	06TC3660T26FD	1,012	1,150	1,268	1,509	1,228	
	Nesting	06TC3660T26NE	1,411	1,547	1,663	NA	1,688	
	Static	06TC3672T26	791	947	1,080	1,377	1,072	
36 x 84	Folding	06TC3672T26FD	1,055	1,210	1,343	1,640	1,349	
	Nesting	06TC3672T26NE	1,473	1,625	1,756	NA	1,828	
	Static	06TC3684T26	952	1,145	1,278	1,576	1,165	
36 x 90	Folding	06TC3684T26FD	1,148	1,340	1,473	1,771	1,370	
	Nest/Lightwt	06TC3684T26NE-LT	1,677	NA	2,008	NA	NA	
	Static	06TC3690T26	1,019	1,239	1,365	1,641	1,175	
36 x 96	Folding	06TC3690T26FD	1,215	1,434	1,560	1,836	1,380	
	Nest/Lightwt	06TC3690T26NE-LT	1,743	NA	2,093	NA	NA	
	Static	06TC3696T26	1,019	1,239	1,379	1,707	1,181	
36 x 96	Folding	06TC3696T26FD	1,215	1,434	1,574	1,902	1,386	
	Nest/Lightwt	06TC3696T26NE-LT	1,743	NA	2,107	NA	NA	



Rectangular with TT-bases	Top Size	Base	Model Number	3P	3K	3W	W1-W4	F1-F5
 	42 x 60	Static	06TC4260TT32	\$ 1,047	\$ 1,209	\$ 1,323	\$ 1,566	\$ 1,192
		Nesting	06TC4260TT32NE	1,798	1,956	2,068	NA	2,023
	42 x 72	Static	06TC4272TT32	1,100	1,294	1,412	1,681	1,294
		Nesting	06TC4272TT32NE	1,877	2,067	2,183	NA	2,152
	42 x 84	Static	06TC4284TT32	1,245	1,471	1,593	1,891	1,387
	42 x 90	Static	06TC4290TT32	1,321	1,576	1,689	1,960	1,408
	42 x 96	Static	06TC4296TT32	1,321	1,576	1,703	2,033	1,419
	48 x 60	Static	06TC4860TT36	1,276	1,461	1,571	1,822	1,483
		Nesting	06TC4860TT36NE	1,993	2,151	2,277	NA	2,337
	48 x 72	Static	06TC4872TT36	1,368	1,590	1,701	1,976	1,615
	Nesting	06TC4872TT36NE	2,072	2,262	2,391	NA	2,466	
48 x 84	Static	06TC4884TT36	1,445	1,670	1,806	2,194	1,707	
48 x 90	Static	06TC4890TT36	1,521	1,776	1,903	2,271	1,750	
48 x 96	Static	06TC4896TT36	1,521	1,776	1,917	2,348	1,760	





Rectangular with 3 TT-bases	Top Size	Base	Model Number	3P	3K	3W	W1-W4	F1-F5
 	42 x 120	Static	06TC42120TT32(3)	\$ 1,950	\$ 2,329	\$ 2,419	\$ 2,634	\$ 2,419
	42 x 144	Static	06TC42144TT32(3)	2,064	2,505	2,603	2,874	2,397
	48 x 120	Static	06TC48120TT36(3)	2,217	2,599	2,700	3,030	2,742
	48 x 144	Static	06TC48144TT36(3)	2,374	2,819	2,928	3,330	2,795

3 bases: **LC** **SH** **CH**  
+135 quote +150

Top Size	Base	Model Number	3P	3K	3W	W1-W4	F1-F5	Boat-Shaped with T-bases
30 x 42 x 84	Static	06BT3084T26	\$1,235	\$1,541	\$1,561	\$2,280	\$1,299	 
30 x 42 x 90	Static	06BT3090T26	1,343	1,692	1,694	2,380	1,325	
30 x 42 x 96	Static	06BT3096T26	1,343	1,692	1,707	2,476	1,337	

Top Size	Base	Model Number	3P	3K	3W	W1-W4	F1-F5	Boat-Shaped with TT-bases
36 x 48 x 84	Static	06BT3684TT32	\$1,582	\$1,930	\$1,926	\$2,662	\$1,563	 
36 x 48 x 90	Static	06BT3690TT32	1,705	2,103	2,075	2,765	1,616	
36 x 48 x 96	Static	06BT3696TT32	1,705	2,103	2,089	2,865	1,628	

Top Size	Base	Model Number	3P	3K	3W	W1-W4	F1-F5	Boat-Shaped with 3 TT-bases
36 x 48 x 120	Static	06BT36120TT36(3)	\$2,654	\$3,212	\$3,134	\$3,823	\$2,742	 
36 x 48 x 144	Static	06BT36144TT36(3)	2,901	3,557	3,461	4,234	2,795	

3 bases: **LC** **SH** **CH**  
+135 quote +150



Racetrack with T-bases	Top Size	Base	Model Number	3P	3K	3W	W1-W4	F1-F5
<div style="display: flex; justify-content: space-around; margin-top: 10px;"> <div style="border: 1px solid black; padding: 2px;">FD</div> <div style="border: 1px solid black; padding: 2px;">NE</div> </div> <p style="font-size: small; margin-top: 5px;">Folding T    Nesting T</p>	36 x 60	Static	06RT3660T26	\$ 876	\$ 1,066	\$ 1,110	\$ 1,708	\$ 1,057
		Nesting	06RT3660T26NE	1,482	1,668	1,711	NA	1,735
	36 x 72	Static	06RT3672T26	967	1,193	1,237	1,889	1,202
		Folding	06RT3672T26FD	1,230	1,456	1,501	2,152	1,479
		Nesting	06RT3672T26NE	1,626	1,847	1,890	NA	1,935
	36 x 84	Static	06RT3684T26	1,130	1,393	1,437	2,141	1,299
		Folding	06RT3684T26FD	1,325	1,589	1,632	2,337	1,504
	36 x 90	Static	06RT3690T26	1,252	1,564	1,585	2,234	1,312
		Folding	06RT3690T26FD	1,447	1,759	1,781	2,429	1,517
	36 x 96	Static	06RT3696T26	1,252	1,564	1,599	2,322	1,318
		Folding	06RT3696T26FD	1,447	1,759	1,794	2,518	1,523



Racetrack with TT-bases	Top Size	Base	Model Number	3P	3K	3W	W1-W4	F1-F5
	42 x 84	Static	06RT4284TT32	\$ 1,472	\$ 1,776	\$ 1,797	\$ 2,519	\$ 1,551
	42 x 90	Static	06RT4290TT32	1,583	1,931	1,933	2,619	1,576
	42 x 96	Static	06RT4296TT32	1,583	1,931	1,947	2,715	1,589
	48 x 84	Static	06RT4884TT36	1,705	2,103	2,061	2,662	1,563
	48 x 90	Static	06RT4890TT36	1,705	2,103	2,075	2,765	1,614
	48 x 96	Static	06RT4896TT36	1,705	2,103	2,089	2,865	1,627



Racetrack with 3 TT-bases	Top Size	Base	Model Number	3P	3K	3W	W1-W4	F1-F5
<div style="border: 1px solid black; padding: 5px; margin-top: 10px; font-size: x-small;">                     3 bases: <b>LC</b> <b>SH</b> <b>CH</b>                      +135 quote +150                 </div>	42 x 120	Static	06RT42120TT32(3)	\$2,384	\$2,936	\$2,854	\$3,393	\$2,419
	42 x 144	Static	06RT42144TT32(3)	2,628	3,278	3,178	3,781	2,440
	48 x 120	Static	06RT48120TT36(3)	2,655	3,213	3,134	3,823	2,742
	48 x 144	Static	06RT48144TT36(3)	2,901	3,558	3,461	4,234	2,795

- LC**  
+90
- OS**  
NA
- CH**  
+100
- WM**  
+125
- WMLC**  
+45
- SH**  
T+130  
TT+260
- FR**  
NA
- PB**  
NA
- GR**  
+40
- CM**  
+50
- RC**  
NA
- GN**  
NA
- LT**  
NA
- AH**  
T+250
- NU**  
NA

Stretch

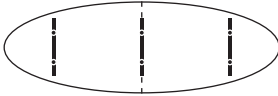

Top Size	Base	Model Number	3P	3K	3W	W1-W4	F1-F5	Elliptical with T-bases
30 x 54	Static	06EL3054T22	\$ 757	\$ 899	\$ 944	\$ 1,501	\$ 828	 
30 x 60	Static	06EL3060T22	794	952	997	1,586	852	
36 x 60	Static	06EL3660T26	876	1,066	1,098	1,708	951	
36 x 72	Static	06EL3672T26	967	1,193	1,219	1,889	1,072	
36 x 84	Static	06EL3684T26	1,130	1,393	1,413	2,141	1,165	
36 x 90	Static	06EL3690T26	1,252	1,564	1,558	2,234	1,211	
36 x 96	Static	06EL3696T26	1,252	1,564	1,569	2,322	1,236	

Top Size	Base	Model Number	3P	3K	3W	W1-W4	F1-F5	Elliptical with TT-bases
42 x 72	Static	06EL4272TT26	\$ 1,301	\$ 1,564	\$ 1,574	\$ 2,259	\$ 1,323	 
42 x 84	Static	06EL4284TT26	1,472	1,776	1,776	2,519	1,416	
42 x 90	Static	06EL4290TT26	1,585	1,934	1,911	2,619	1,437	
42 x 96	Static	06EL4296TT26	1,585	1,934	1,922	2,715	1,448	
48 x 72	Static	06EL4872TT32	1,423	1,735	1,719	2,389	1,435	
48 x 84	Static	06EL4884TT32	1,503	1,820	1,822	2,662	1,528	
48 x 90	Static	06EL4890TT32	1,705	2,103	2,055	2,765	1,570	
48 x 96	Static	06EL4896TT32	1,705	2,103	2,066	2,865	1,580	

Top Size	Base	Model Number	3P	3K	3W	W1-W4	F1-F5	Elliptical with 3 TT-bases
42 x 120	Static	06EL42120TT26(3)	\$ 2,384	\$ 2,936	\$ 2,816	\$ 3,393	\$ 2,419	 
42 x 144	Static	06EL42144TT26(3)	2,628	3,278	3,128	3,781	2,440	
48 x 120	Static	06EL48120TT36(3)	2,655	3,213	3,099	3,823	2,742	
48 x 144	Static	06EL48144TT36(3)	2,901	3,558	3,413	4,234	2,795	



3 bases: **LC** **SH** **CH**  
 +135 quote +150

- LC**  
+90
- OS**  
NA
- CH**  
+100
- WM**  
+125
- WMLC**  
+45
- SH**  
T+130  
TT+260
- FR**  
NA
- PB**  
NA
- GR**  
+40
- CM**  
+50
- RC**  
NA
- GN**  
NA
- LT**  
NA
- AH**  
T+250
- NU**  
NA



Square with X-base	Top Size	Base	Model Number	3P	3K	3W	W1-W4	F1-F5
 	24 x 24	Static	06SQ2424X22	\$ 546	\$ 585	\$ 667	\$ 797	\$ 600
		Flip Top	06SQ2424X22FT	672	711	793	923	732
	30 x 30	Static	06SQ3030X26	599	658	753	910	657
		Flip Top	06SQ3030X26FT	725	784	878	1,036	789
	36 x 36	Static	06SQ3636X32	700	784	887	1,071	847
		Flip Top	06SQ3636X32FT	826	910	1,013	1,197	979



Flip Top X

Square with 4-column X-base	Top Size	Base	Model Number	3P	3K	3W	W1-W4	F1-F5
 	42 x 42	Static	06SQ4242X36.4	\$ 1,276	\$ 1,389	\$ 1,498	\$ 1,708	\$ 1,395
	48 x 48	Static	06SQ4848X36.4	1,360	1,507	1,618	1,851	1,416
	54 x 54	Static	06SQ5454X36.4	1,455	1,640	1,751	2,005	NA

X.4 bases: **SH** **CH**  
+260 NA



Square with TT-bases	Top Size	Base	Model Number	3P	3K	3W	W1-W4	F1-F5
 	48 x 48	Static	06SQ4848TT32	\$ 1,010	\$ 1,157	\$ 1,268	\$ 1,501	\$ 1,049
		Nesting	06SQ4848TT32NE	1,788	1,933	2,042	NA	1,911





Nesting TT

- LC**  
+90
- OS**  
NA
- CH**  
+100
- WM**  
+125
- WMLC**  
+45
- SH**  
X+65  
TT+260
- FR**  
NA
- PB**  
+90
- GR**  
+40
- CM**  
+50
- RC**  
+55
- GN**  
+40
- LT**  
+115
- AH**  
X+125
- NU**  
NA

Stretch

Top Size	Base	Model Number	3P	3K	3W	W1-W4	F1-F5	Round with X-base
24 x 24	Static	06RD24X22	\$ 578	\$ 629	\$ 678	\$1,005	\$ 600	 
	Flip Top	06RD24X22FT	704	755	804	1,130	732	
30 x 30	Static	06RD30X26	649	728	778	1,187	657	
	Flip Top	06RD30X26FT	775	854	904	1,313	789	
36 x 36	Static	06RD36X32	762	870	919	1,425	847	
	Flip Top	06RD36X32FT	887	996	1,045	1,551	979	
42 x 42	Static	06RD42X32	859	1,007	1,048	1,645	868	
	Flip Top	06RD42X32FT	985	1,133	1,174	1,771	1,000	



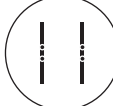

Top Size	Base	Model Number	3P	3K	3W	W1-W4	F1-F5	Round with 4-column X-base
48 x 48	Static	06RD48X36.4	\$1,389	\$1,547	\$1,602	\$2,385	\$1,416	 
54 x 54	Static	06RD54X36.4	1,548	1,770	1,799	2,647	NA	
60 x 60	Static	06RD60X36.4	1,570	1,801	1,846	2,924	NA	

X.4 bases: **SH** **CH**  
+260 NA

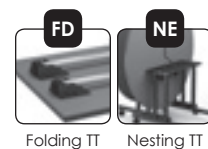
Top Size	Base	Model Number	3P	3K	3W	W1-W4	F1-F5	Round with TT-base
48 x 48	Static	06RD48TT26	\$1,039	\$1,197	\$1,252	\$2,035	\$1,049	 
	Nesting	06RD48TT26NE	1,817	1,972	2,026	NA	1,911	
54 x 54	Static	06RD54TT32	1,198	1,420	1,449	2,297	NA	
	Nesting	06RD54TT32NE	1,973	2,191	2,220	NA	NA	
60 x 60	Static	06RD60TT32	1,220	1,451	1,496	2,574	NA	
	Folding	06RD60TT32FD	1,803	2,034	2,078	NA	NA	
	Nesting	06RD60TT32NE	1,995	2,221	2,265	NA	NA	



D-shaped with T-bases	Top Size	Base	Model Number	3P	3K	3W	W1-W4	F1-F5
	24 x 36	Static	06D2436T22	\$ 588	\$ 663	\$ 733	\$ 1,024	\$ 636
		Nesting	06D2436T22NE	1,012	1,086	1,155	NA	1,101
	24 x 48	Static	06D2448T22	650	750	830	1,158	709
		Nesting	06D2448T22NE	1,074	1,172	1,249	NA	1,173
	24 x 60	Static	06D2460T22	713	838	926	1,293	782
		Nesting	06D2460T22NE	1,162	1,285	1,371	NA	1,273
	24 x 72	Static	06D2472T22	775	925	1,023	1,428	855
		Nesting	06D2472T22NE	1,317	1,464	1,560	NA	1,468
 Nesting T	24 x 84	Static	06D2484T22	906	1,081	1,187	1,631	1,000
		Nesting	06D2484T22NE	1,519	1,690	1,794	NA	1,686
	24 x 90	Static	06D2490T22	937	1,125	1,235	1,700	1,036
		Nesting	06D2490T22NE	1,549	1,733	1,842	NA	1,722
	24 x 96	Static	06D2496T22	968	1,168	1,284	1,769	1,072
		Nesting	06D2496T22NE	1,580	1,776	1,889	NA	1,758
	30 x 48	Static	06D3048T26	716	841	912	1,257	785
		Nesting	06D3048T26NE	1,138	1,260	1,330	NA	1,247
	30 x 60	Static	06D3060T26	794	950	1,026	1,404	855
		Nesting	06D3060T26NE	1,242	1,395	1,469	NA	1,344
	30 x 72	Static	06D3072T26	872	1,059	1,139	1,550	967
		Nesting	06D3072T26NE	1,412	1,596	1,674	NA	1,578
	30 x 84	Static	06D3084T26	1,018	1,237	1,321	1,764	1,130
		Nesting	06D3084T26NE	1,629	1,843	1,926	NA	1,814
	30 x 90	Static	06D3090T26	1,057	1,292	1,378	1,837	1,176
		Nest/Lightwt	06D3090T26NE-LT	1,742	NA	NA	NA	NA
	30 x 96	Static	06D3096T26	1,096	1,346	1,435	1,910	1,221
		Nest/Lightwt	06D3096T26NE-LT	1,818	NA	NA	NA	NA
	36 x 48	Static	06D3648T26	778	928	992	1,354	858
		Nesting	06D3648T26NE	1,199	1,346	1,408	NA	1,318
	36 x 60	Static	06D3660T26	872	1,059	1,123	1,511	967
		Nesting	06D3660T26NE	1,440	1,624	1,686	NA	1,582
	36 x 72	Static	06D3672T26	966	1,191	1,253	1,665	1,072
		Nesting	06D3672T26NE	1,624	1,845	1,906	NA	1,807
	36 x 84	Static	06D3684T26	1,127	1,390	1,452	1,891	1,165
		Nest/Lightwt	06D3684T26NE-LT	1,849	NA	NA	NA	NA
	36 x 90	Static	06D3690T26	1,174	1,456	1,518	1,972	1,319
		Nest/Lightwt	06D3690T26NE-LT	1,895	NA	NA	NA	NA
	36 x 96	Static	06D3696T26	1,221	1,521	1,583	2,049	1,329
		Nest/Lightwt	06D3696T26NE-LT	1,941	NA	NA	NA	NA

new

Stretch

- LC  
+90
- OS  
+35
- CH  
+100
- WM  
+125
- WMLC  
+45
- SH  
T+130
- FR  
NA
- PB  
NA
- GR  
+40
- CM  
+50
- RC  
+55
- GN  
+40
- LT  
NA
- AH  
T+250
- NU  
NA



Top Size	Base	Model Number	3P	3K	3W	W1-W4	F1-F5	D-shaped with TT-bases
42 x 60	Static	06D4260TT32	\$ 1,189	\$ 1,408	\$ 1,459	\$ 1,855	\$ 1,310	
	Nesting	06D4260TT32NE	1,964	2,179	2,229	NA	2,167	
42 x 72	Static	06D4272TT32	1,299	1,561	1,607	2,024	1,323	
	Nesting	06D4272TT32NE	2,072	2,329	2,374	NA	2,180	
42 x 84	Static	06D4284TT32	1,577	1,923	1,933	2,257	1,416	
42 x 90	Static	06D4290TT32	1,639	2,010	2,015	2,342	1,437	
42 x 96	Static	06D4296TT32	1,701	2,096	2,097	2,427	1,580	
48 x 60	Static	06D4860TT36	1,439	1,689	1,727	2,134	1,581	
	Nesting	06D4860TT36NE	2,209	2,454	2,492	NA	2,433	
48 x 72	Static	06D4872TT36	1,564	1,864	1,892	2,311	1,615	
	Nesting	06D4872TT36NE	2,332	2,626	2,654	NA	2,466	
48 x 84	Static	06D4884TT36	1,757	2,107	2,125	2,560	1,707	
48 x 90	Static	06D4890TT36	1,819	2,194	2,208	2,737	1,750	
48 x 96	Static	06D4896TT36	1,882	2,282	2,290	2,737	1,760	





new



Top Size	Base	Model Number	3P	3K	3W	W1-W4	F1-F5	D-shaped with 4-column X-base
54 x 54	Static	06D5454X36.4	\$ 1,766	\$ 2,075	\$ 2,080	\$ 2,328	NA	



X.4 bases: **SH** **CH**  
+260 NA

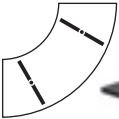

Stretch

- LC**  
+90
- OS**  
NA
- CH**  
+100
- WM**  
+125
- WMLC**  
+45
- SH**  
TT+260
- FR**  
NA
- PB**  
NA
- GR**  
+40
- CM**  
+50
- RC**  
+55
- GN**  
+40
- LT**  
NA
- AH**  
T+250
- NU**  
NA

Half Round with T-bases	Top Size	Base	Model Number	3P	3K	3W	W1-W4	F1-F5
   <p>Nesting T</p>	24 x 48	Static	06HR2448T18	\$ 653	\$ 754	\$ 821	\$ 1,474	\$ 709
		Nesting	06HR2448T18NE	1,076	1,176	1,241	NA	1,173
	30 x 60	Static	06HR3060T22	792	949	1,010	1,793	873
		Nesting	06HR3060T22NE	1,213	1,367	1,426	NA	1,333
	36 x 72	Static	06HR3672T26	964	1,189	1,234	2,142	1,077
		Nesting	06HR3672T26NE	1,568	1,788	1,833	NA	1,689

Crescent with T-bases	Top Size	Base	Model Number	3P	3K	3W	W1-W4	F1-F5
 	24 x 48 x 75	Static	06CS2475T22	\$ 1,195	\$ 1,513	\$ 1,461	\$ 1,797	\$ 1,560
	24 x 60 x 94	Static	06CS2494T22	1,518	1,965	1,865	2,074	1,560
	30 x 60 x 94	Static	06CS3094T26	1,521	1,968	1,865	2,235	1,563

Trapezoid with T-bases	Top Size	Base	Model Number	3P	3K	3W	W1-W4	F1-F5
   <p>Nesting T</p>	24 x 48	Static	06TZ2448T18	\$ 645	\$ 743	\$ 808	\$ 1,255	\$ 709
	24 x 72	Static	06TZ2472T18	804	965	1,038	1,593	855
		Nesting	06TZ2472T18NE	1,251	1,409	1,481	NA	1,344
	30 x 60	Static	06TZ3060T22	751	891	959	1,562	873
		Nesting	06TZ3060T22NE	1,172	1,310	1,376	NA	1,333
	36 x 72	Static	06TZ3672T26	942	1,158	1,204	1,908	1,077
	Nesting	06TZ3672T26NE	1,519	1,731	1,776	NA	1,725	

Corner with T-bases	Top Size	Base	Model Number	3P	3K	3W	W1-W4	F1-F5
 	24 x 42	Static	06CR2442T26	\$ 823	\$ 991	\$ 1,050	\$ 1,708	\$ 676
	30 x 48	Static	06CR3048T32	865	1,046	1,123	1,990	794

- LC  
+90
- OS  
+35
- CH  
+100
- WM  
+125
- WMLC  
+45
- SH  
T+130
- FR  
NA
- PB  
NA
- GR  
+40
- CM  
+50
- RC  
+55
- GN  
+40
- LT  
NA
- AH  
T+250
- NU  
NA

Top Size	Base	Model Number	3P	3K	3W	W1-W4	F1-F5	Arc Segment with T-bases
20 x 44	Static	06AS2044T18	\$ 678	\$ 789	\$ 821	NA	\$ 640	
24 x 51	Static	06AS2451T18	747	886	914	NA	734	
30 x 59	Static	06AS3059T26	820	986	1,018	NA	876	
36 x 67	Static	06AS3667T26	986	1,219	1,242	NA	1,077	

Top Size	Base	Model Number	3P	3K	3W	W1-W4	F1-F5	Ganging Quarter Round (with T-base)
20 x 20	Ganging	QR2020GN	\$ 224	\$ 272	\$ 319	NA	\$ 236	
24 x 24	Ganging	QR2424GN	233	284	344	NA	236	
30 x 30	Static, GN	06QR3030GNT26	474	552	617	NA	474	
	Ganging	QR3030GN	301	380	444	NA	292	
36 x 36	Static, GN	06QR3636GNT26	538	642	712	NA	623	
	Ganging	QR3636GN	365	469	540	NA	442	

1 base: **LC** **OS** **CH** **SH**  
 NA +18 +50 +65



Top Size	Base	Model Number	3P	3K	3W	W1-W4	F1-F5	Ganging 45° Wedge (with T-base)
20 x 20	Ganging	WG45D20GN	\$ 224	\$ 272	\$ 315	NA	\$ 236	
24 x 24	Ganging	WG45D24GN	233	284	337	NA	236	
30 x 30	Ganging	WG45D30GN	301	380	432	NA	292	
36 x 36	Static, GN	06WG45D36GNT26	538	642	693	NA	623	
	Ganging	WG45D36GN	365	469	520	NA	442	

1 base: **LC** **OS** **CH** **SH**  
 NA +18 +50 +65







Top Size	Base	Model Number	3P	3K	3W	W1-W4	F1-F5	Ganging 60° Wedge (with T-base)
20 x 20	Ganging	WG60D20GN	\$ 246	\$ 302	\$ 343	NA	\$ 236	
24 x 24	Ganging	WG60D24GN	254	314	366	NA	236	
30 x 30	Static, GN	06WG60D30GNT26	495	582	635	NA	474	
	Ganging	WG60D30GN	322	410	462	NA	292	
36 x 36	Static, GN	06WG60D36GNT26	559	672	726	NA	623	
	Ganging	WG30D36GN	386	499	553	NA	442	



1 base: **LC** **OS** **CH** **SH**  
 NA +18 +50 +65





- LC**  
+90
- OS**  
+35
- CH**  
+100
- WM**  
+125
- WMLC**  
+45
- SH**  
T+130
- FR**  
NA
- PB**  
NA
- GR**  
+40
- CM**  
+50
- RC**  
+55
- GN**  
+40
- LT**  
NA
- AH**  
T+250
- NU**  
NA

Video Wedge with T-bases	Top Size	Base	Model Number	3P	3K	3W	W1-W4	F1-F5
 	20 x 20 x 40	Static	06VW2040T18	\$ 635	\$ 729	\$ 789	NA	\$ 620
	24 x 24 x 48	Static	06VW2448T18	678	789	862	NA	709
	30 x 30 x 60	Static	06VW3060T26	820	986	1,056	NA	876
	36 x 36 x 72	Static	06VW3672T26	1,070	1,336	1,370	NA	1,077

10° Transition with T-bases	Top Size	Base	Model Number	3P	3K	3W	W1-W4	F1-F5
 	20 x 30	Static	06TN2030T18	\$ 539	\$ 595	\$ 660	NA	\$ 569
	24 x 30	Static	06TN2430T18	550	610	680	NA	600
	30 x 30	Static	06TN3030T26	608	690	756	NA	648
	36 x 30	Static	06TN3630T26	672	780	838	NA	694

Trident with 3 Offset T-bases	Top Size	Base	Model Number	3P	3K	3W	W1-W4	F1-F5
 	40 x 40 x 20	Static	06TR4020TOS18(3)	\$ 1,213	\$ 1,447	\$ 1,413	\$ 1,762	\$ 1,260
	48 x 48 x 24	Static	06TR4824TOS18(3)	1,226	1,465	1,456	2,035	1,260
	60 x 60 x 30	Static	06TR6030TOS18(3)	1,413	1,728	1,704	2,470	NA



3 bases: **LC** **SH** **CH**  
+135 +195 +150



Quadrant with 4-Column X-base	Top Size	Base	Model Number	3P	3K	3W	W1-W4	F1-F5
 	60 x 60 x 20	Static	06QD6020X36.4	\$ 1,822	\$ 2,154	\$ 2,142	\$ 2,993	NA
	60 x 60 x 24	Static	06QD6024X36.4	1,822	2,154	2,146	2,993	NA
	60 x 60 x 30	Static	06QD6030X36.4	1,822	2,154	2,152	2,993	NA



X.4 bases: **SH** **CH**  
+260 NA

- LC**  
+90
- OS**  
+35
- CH**  
+100
- WM**  
+125
- WMLC**  
+45
- SH**  
T+130
- FR**  
NA
- PB**  
NA
- GR**  
+40
- CM**  
+50
- RC**  
+55
- GN**  
+40
- LT**  
NA
- AH**  
T+250
- NU**  
NA

Stretch

Top Size	Base	Model Number	3P	3K	3W	W1-W4	F1-F5	Bulb with X-base
30 x 30 x 20	Static	06BU3020X26	\$ 818	\$ 965	\$ 969	\$ 1,629	\$ 700	 
36 x 36 x 24	Static	06BU3624X32	962	1,151	1,147	1,933	840	
42 x 42 x 30	Static	06BU4230X32	1,059	1,287	1,276	2,218	959	

Top Size	Base	Model Number	3P	3K	3W	W1-W4	F1-F5	Squircle with X-base
24 x 24	Static	06SL24X22	\$ 731	\$ 844	\$ 870	\$ NA	\$ 600	 
	Flip Top	06SL24X22FT	857	970	996	NA	732	
30 x 30	Static	06SL30X26	781	913	953	NA	657	
	Flip Top	06SL30X26FT	907	1,039	1,079	NA	789	
36 x 36	Static	06SL36X32	874	1,027	1,078	NA	847	
	Flip Top	06SL36X32FT	1,000	1,153	1,204	NA	979	
42 x 42	Static	06SL42X32	933	1,110	1,171	NA	868	
	Flip Top	06SL42X32FT	1,059	1,236	1,297	NA	1,000	

Top Size	Base	Model Number	3P	3K	3W	W1-W4	F1-F5	Table Desk with T-bases
37 x 60	Static	06TA3760T26	\$ 866	\$ 1,051	\$ 1,159	\$ 1,850	\$ 983	 
42 x 78	Static	06TA4278T32	1,198	1,485	1,574	2,350	1,395	

Stretch

- LC**  
+90
- OS**  
+35
- CH**  
+100
- WM**  
+125
- WMLC**  
+45
- SH**  
X+65  
T+130
- FR**  
NA
- PB**  
+90
- GR**  
+40
- CM**  
+50
- RC**  
+55
- GN**  
+40
- LT**  
NA
- AH**  
X+125  
T+250
- NU**  
NA



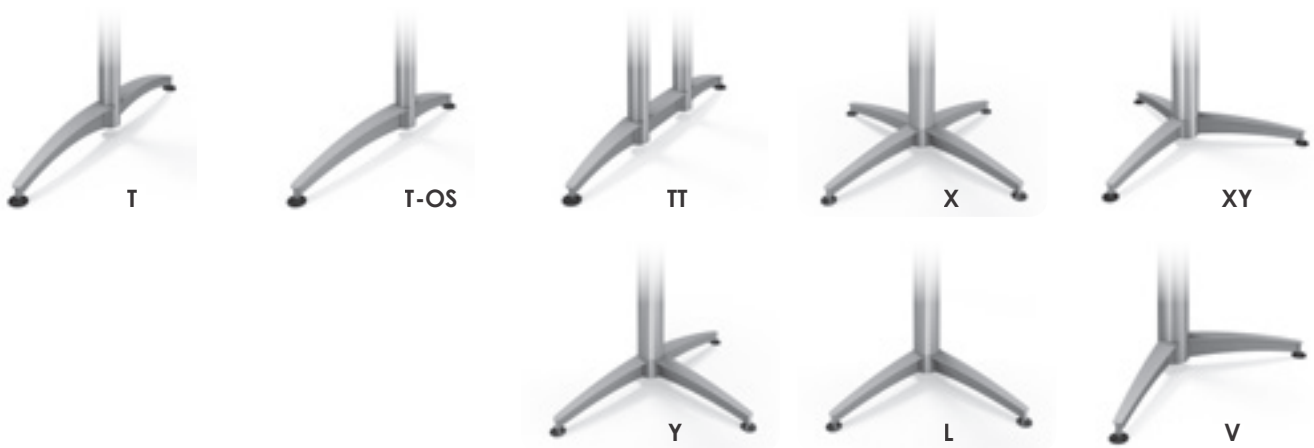

Elite has a designer friendly style and our most comprehensive offering. The welded base enables lasting functionality without sacrificing beauty.

### Elite Base Styles



### Elite Base Options

- 

standard plastic gliders
- 

locking casters
- LC** **Locking Casters** can be added to any table for \$90.
- FD** **Folding Bases** priced accordingly with standard glides.
- NE** **Nesting Tables** priced accordingly with locking casters.
- OS** **Offset Bases** available for \$70.
- FT** **Flip Tops** available on X-based tables and are priced with standard glides.
- CH** **Chrome Finish** is not available on Elite tables.
- WM** **Wire Management** Built in wire management is available on one leg for \$125.
- WMLC** **Wire Management Leg Covers** snap onto any leg and are \$45 each.
- SH** **Special Height** of can be added to any table:  
 + \$65 per column for heights > 29"  
 + \$35 per column for heights < 29"  
 Special height tables larger than 36x72" must be custom quoted.
- FR** **Footring** is not available on the Elite series.
- PB** **Power Box Mounting Plate** is available on X-bases for \$90.

Elite

## Elite Height Adjustable Options

- AH Spring Clip**  
is available on X-bases for \$125 and on T-bases for \$250 per table.
- NU Pneumatic**  
is not available on Elite bases.
- RA Ratchet**  
is not available on Elite bases.
- BL Counterbalanced**  
is not available on Elite bases.

## Elite Top Shapes

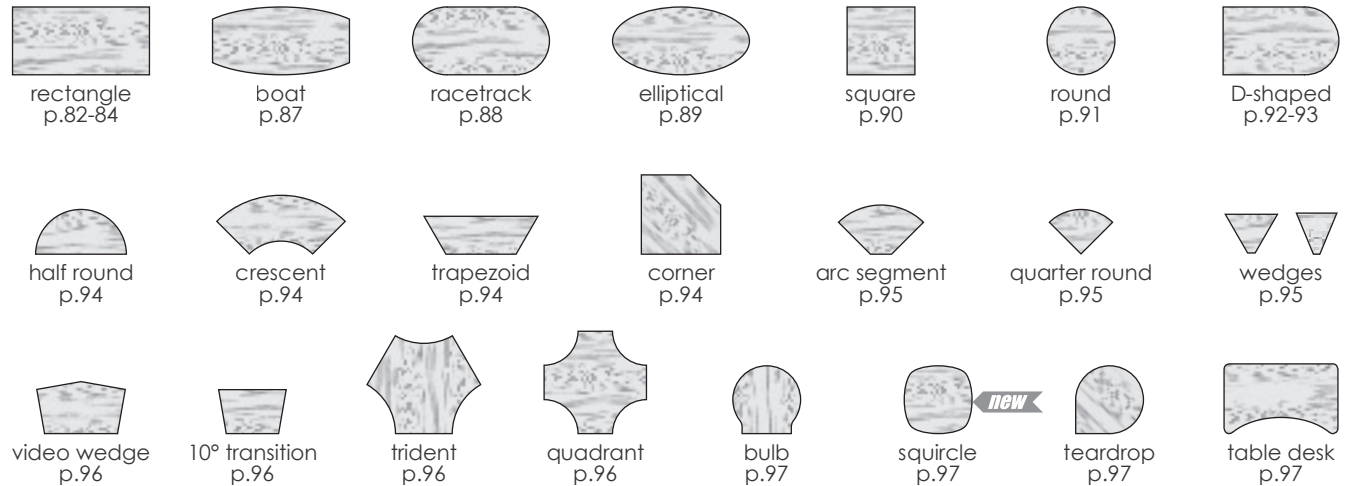

## Elite Top Options

- RC 3" Radius Corners**  
can be added to any table for \$55.
- LT Lightweight Tops**  
can be added to any square or rectangular table for \$115. This is a great option when specifying folding tables.
- GR Grommets**  
can be added to any table for \$40 each. To see specific locations, see page 203.
- CM Cable Manager**  
can be added to any table for \$50 each. To see specific locations, see page 203.

## Elite Edge Options

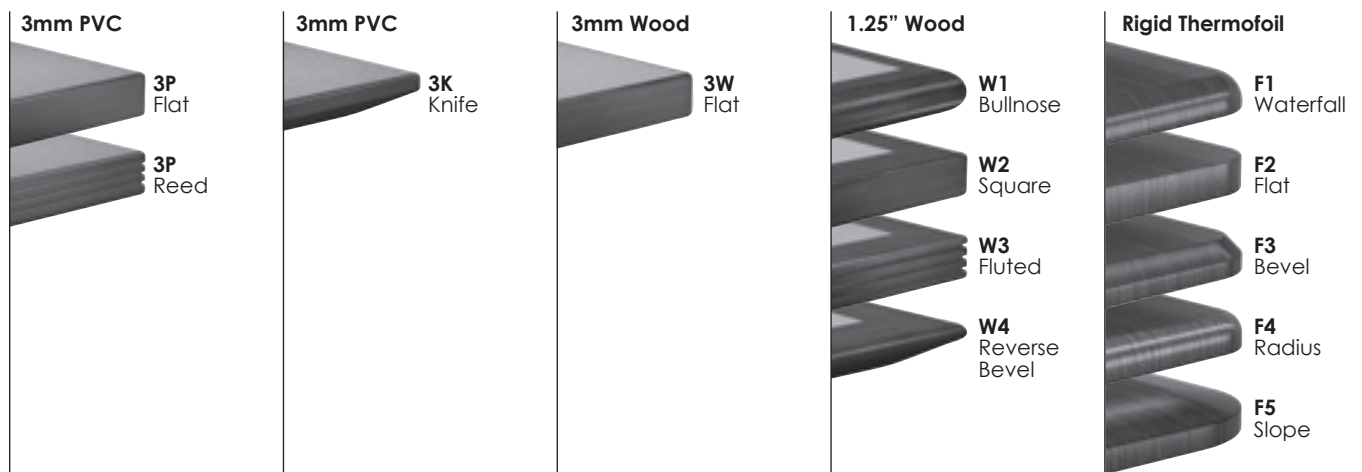

(correspond with 5 columns of pricing)





Rectangular with T-bases	Top Size	Base	Model Number	3P	3K	3W	W1-W4	F1-F5
    <p>Folding T    Nesting T</p>	20 x 36	Static	08TC2036T18	\$ 653	\$ 710	\$ 796	\$ 923	\$ 693
		Nesting	08TC2036T18NE	1,076	1,132	1,217	NA	1,156
		20 x 48	Static	08TC2048T18	699	774	874	1,027
	Folding		08TC2048T18FD	952	1,027	1,128	1,280	976
	Nesting		08TC2048T18NE	1,148	1,222	1,321	NA	1,202
	20 x 60	Static	08TC2060T18	720	804	926	1,127	797
		Folding	08TC2060T18FD	983	1,067	1,189	1,390	1,074
		Nesting	08TC2060T18NE	1,225	1,307	1,427	NA	1,347
	20 x 72	Static	08TC2072T18	828	927	1,065	1,299	907
		Folding	08TC2072T18FD	1,023	1,123	1,260	1,494	1,112
		Nesting	08TC2072T18NE	1,442	1,539	1,675	NA	1,595
	20 x 84	Static	08TC2084T18	905	1,035	1,177	1,403	1,029
		Folding	08TC2084T18FD	1,100	1,230	1,373	1,598	1,234
		Nesting	08TC2084T18NE	1,517	1,645	1,785	NA	1,715
	20 x 90	Static	08TC2090T18	951	1,099	1,242	1,453	1,029
		Folding	08TC2090T18FD	1,146	1,294	1,437	1,648	1,234
		Nesting	08TC2090T18NE	1,562	1,708	1,848	NA	1,715
	20 x 96	Static	08TC2096T18	951	1,099	1,255	1,503	1,050
Folding		08TC2096T18FD	1,146	1,294	1,451	1,698	1,255	
Nesting		08TC2096T18NE	1,562	1,708	1,861	NA	1,736	
24 x 36	Static	08TC2436T22	653	710	806	965	754	
	Nesting	08TC2436T22NE	1,076	1,132	1,226	NA	1,216	
24 x 48	Static	08TC2448T22	699	774	884	1,073	771	
	Folding	08TC2448T22FD	952	1,027	1,137	1,326	1,037	
	Nesting	08TC2448T22NE	1,148	1,222	1,330	NA	1,262	
24 x 60	Static	08TC2460T22	720	804	935	1,184	835	
	Folding	08TC2460T22FD	983	1,067	1,198	1,448	1,112	
	Nesting	08TC2460T22NE	1,225	1,307	1,436	NA	1,384	
24 x 72	Static	08TC2472T22	760	859	1,006	1,292	868	
	Folding	08TC2472T22FD	1,023	1,123	1,270	1,556	1,145	
	Nesting	08TC2472T22NE	1,442	1,539	1,684	NA	1,628	
24 x 84	Static	08TC2484T22	905	1,035	1,187	1,472	1,104	
	Folding	08TC2484T22FD	1,100	1,230	1,382	1,667	1,309	
	Nesting	08TC2484T22NE	1,517	1,645	1,794	NA	1,789	
24 x 90	Static	08TC2490T22	951	1,099	1,251	1,526	1,115	
	Folding	08TC2490T22FD	1,146	1,294	1,446	1,721	1,320	
	Nesting	08TC2490T22NE	1,562	1,708	1,857	NA	1,799	
24 x 96	Static	08TC2496T22	951	1,099	1,265	1,580	1,125	
	Folding	08TC2496T22FD	1,146	1,294	1,460	1,775	1,331	
	Nesting	08TC2496T22NE	1,562	1,708	1,870	NA	1,810	

Elite

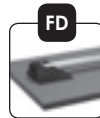
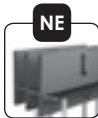





Top Size	Base	Model Number	3P	3K	3W	W1-W4	F1-F5	Rectangular with T-bases
30 x 36	Static	08TC3036T26	\$ 696	\$ 766	\$ 866	\$1,036	\$ 807	    <p>Folding T Nesting T</p>
	Nesting	08TC3036T26NE	1,118	1,187	1,285	NA	1,268	
30 x 48	Static	08TC3048T26	753	846	956	1,159	818	
	Folding	08TC3048T26FD	1,006	1,099	1,209	1,412	1,083	
30 x 60	Nesting	08TC3048T26NE	1,201	1,292	1,401	NA	1,307	
	Static	08TC3060T26	770	871	1,003	1,278	977	
	Folding	08TC3060T26FD	1,034	1,134	1,267	1,542	1,254	
30 x 72	Nesting	08TC3060T26NE	1,275	1,373	1,503	NA	1,523	
	Static	08TC3072T26	815	933	1,080	1,397	1,053	
	Folding	08TC3072T26FD	1,078	1,196	1,343	1,661	1,330	
30 x 84	Nesting	08TC3072T26NE	1,496	1,612	1,756	NA	1,809	
	Static	08TC3084T26	991	1,153	1,295	1,585	1,135	
	Folding	08TC3084T26FD	1,187	1,348	1,490	1,780	1,340	
30 x 90	Nesting	08TC3084T26NE	1,602	1,761	1,900	NA	1,819	
	Static	08TC3090T26	1,048	1,233	1,372	1,646	1,156	
	Folding	08TC3090T26FD	1,244	1,428	1,567	1,842	1,361	
30 x 96	Nest/Lightwt	08TC3090T26NE-LT	1,772	NA	2,100	NA	NA	
	Static	08TC3096T26	1,048	1,233	1,385	1,704	1,167	
	Folding	08TC3096T26FD	1,244	1,428	1,581	1,899	1,372	
36 x 48	Nest/Lightwt	08TC3096T26NE-LT	1,772	NA	2,113	NA	NA	
	Static	08TC3648T26	798	909	1,019	1,232	867	
	Folding	08TC3648T26FD	1,051	1,162	1,272	1,485	1,133	
36 x 60	Nesting	08TC3648T26NE	1,405	1,513	1,622	NA	1,549	
	Static	08TC3660T26	865	1,004	1,122	1,363	1,074	
	Folding	08TC3660T26FD	1,129	1,267	1,385	1,626	1,351	
36 x 72	Nesting	08TC3660T26NE	1,526	1,661	1,777	NA	1,809	
	Static	08TC3672T26	908	1,064	1,196	1,494	1,195	
	Folding	08TC3672T26FD	1,172	1,327	1,460	1,757	1,471	
36 x 84	Nesting	08TC3672T26NE	1,588	1,740	1,870	NA	1,948	
	Static	08TC3684T26	1,069	1,262	1,394	1,693	1,288	
	Folding	08TC3684T26FD	1,265	1,457	1,590	1,888	1,493	
36 x 90	Nesting	08TC3684T26NE	1,792	NA	2,122	NA	NA	
	Static	08TC3690T26	1,136	1,356	1,482	1,758	1,298	
	Folding	08TC3690T26FD	1,332	1,551	1,677	1,953	1,503	
36 x 96	Nest/Lightwt	08TC3690T26NE-LT	1,858	NA	2,208	NA	NA	
	Static	08TC3696T26	1,136	1,356	1,496	1,823	1,303	
	Folding	08TC3696T26FD	1,332	1,551	1,691	2,019	1,509	
36 x 96	Nest/Lightwt	08TC3696T26NE-LT	1,858	NA	2,222	NA	NA	



Rectangular with V-bases	Top Size	Base	Model Number	3P	3K	3W	W1-W4	F1-F5
 	24 x 48	Static	08TC2448V22	\$ 834	\$ 909	\$ 1,019	\$ 1,209	\$ 913
		Nesting	08TC2448V22NE	1,281	1,355	1,463	NA	1,401
	24 x 60	Static	08TC2460V22	856	939	1,071	1,320	978
		Nesting	08TC2460V22NE	1,358	1,440	1,569	NA	1,523
	24 x 72	Static	08TC2472V22	895	995	1,142	1,428	1,011
		Nesting	08TC2472V22NE	1,575	1,673	1,817	NA	1,768
	24 x 84	Static	08TC2484V22	1,040	1,171	1,322	1,608	1,247
		Nesting	08TC2484V22NE	1,650	1,778	1,927	NA	1,929
	24 x 90	Static	08TC2490V22	1,086	1,235	1,387	1,661	1,257
		Nesting	08TC2490V22NE	1,695	1,841	1,990	NA	1,939
 Nesting T	24 x 96	Static	08TC2496V22	1,086	1,235	1,400	1,715	1,268
		Nesting	08TC2496V22NE	1,695	1,841	2,004	NA	1,949
	30 x 48	Static	08TC3048V26	911	1,004	1,114	1,317	983
		Nesting	08TC3048V26NE	1,356	1,447	1,556	NA	1,470
	30 x 60	Static	08TC3060V26	928	1,029	1,161	1,436	1,143
		Nesting	08TC3060V26NE	1,430	1,528	1,658	NA	1,686
	30 x 72	Static	08TC3072V26	973	1,091	1,238	1,555	1,219
		Nesting	08TC3072V26NE	1,651	1,767	1,911	NA	1,971
	30 x 84	Static	08TC3084V26	1,149	1,311	1,453	1,743	1,301
		Nesting	08TC3084V26NE	1,757	1,916	2,055	NA	1,982
	30 x 90	Static	08TC3090V26	1,206	1,391	1,530	1,804	1,322
		Nest/Lightwt	08TC3090V26NE-LT	1,927	NA	2,255	NA	NA
	30 x 96	Static	08TC3096V26	1,206	1,391	1,543	1,862	1,333
		Nest/Lightwt	08TC3096V26NE-LT	1,927	NA	2,268	NA	NA
	36 x 48	Static	08TC3648V26	956	1,067	1,177	1,390	1,033
		Nesting	08TC3648V26NE	1,560	1,668	1,777	NA	1,711
	36 x 60	Static	08TC3660V26	1,023	1,162	1,280	1,521	1,240
		Nesting	08TC3660V26NE	1,681	1,816	1,932	NA	1,971
	36 x 72	Static	08TC3672V26	1,066	1,222	1,354	1,652	1,361
		Nesting	08TC3672V26NE	1,743	1,895	2,025	NA	2,111
	36 x 84	Static	08TC3684V26	1,227	1,420	1,552	1,851	1,453
		Nest/Lightwt	08TC3684V26NE-LT	1,947	NA	2,277	NA	NA
	36 x 90	Static	08TC3690V26	1,294	1,514	1,640	1,916	1,464
		Nest/Lightwt	08TC3690V26NE-LT	2,013	NA	2,363	NA	NA
	36 x 96	Static	08TC3696V26	1,294	1,514	1,654	1,981	1,469
		Nest/Lightwt	08TC3696V26NE-LT	2,013	NA	2,377	NA	NA

Elite

- LC**  
+90
- OS**  
NA
- CH**  
NA
- WM**  
+125
- WMLC**  
+45
- SH**  
T+130
- FR**  
NA
- PB**  
NA
- GR**  
+40
- CM**  
+50
- RC**  
+55
- GN**  
+40
- LT**  
+115
- AH**  
T+250

Top Size	Base	Model Number	3P	3K	3W	W1-W4	F1-F5	Rectangle with TT-bases
42 x 60	Static	08TC4260TT32	\$ 1,248	\$ 1,410	\$ 1,524	\$ 1,767	\$ 1,403	   <p>Nesting TT</p>
	Nesting	08TC4260TT32NE	2,022	2,181	2,293	NA	2,259	
42 x 72	Static	08TC4272TT32	1,329	1,523	1,641	1,910	1,535	
	Nesting	08TC4272TT32NE	2,102	2,292	2,407	NA	2,388	
42 x 84	Static	08TC4284TT32	1,475	1,700	1,822	2,120	1,628	
42 x 90	Static	08TC4290TT32	1,550	1,805	1,918	2,190	1,649	
42 x 96	Static	08TC4296TT32	1,550	1,805	1,932	2,263	1,659	
48 x 60	Static	08TC4860TT32	1,306	1,491	1,602	1,852	1,515	
	Nesting	08TC4860TT32NE	2,022	2,181	2,307	NA	2,368	
48 x 72	Static	08TC4872TT32	1,398	1,620	1,731	2,006	1,646	
	Nesting	08TC4872TT32NE	2,102	2,292	2,421	NA	2,497	
48 x 84	Static	08TC4884TT32	1,475	1,700	1,836	2,224	1,739	
48 x 90	Static	08TC4890TT32	1,551	1,806	1,933	2,301	1,781	
48 x 96	Static	08TC4896TT32	1,551	1,806	1,947	2,378	1,792	



Top Size	Base	Model Number	3P	3K	3W	W1-W4	F1-F5	Rectangle with Y-bases
42 x 60	Static	08TC4260Y36	1,357	1,519	1,633	1,877	1,518	 
42 x 72	Static	08TC4272Y36	1,438	1,632	1,750	2,019	1,649	
42 x 84	Static	08TC4284Y36	1,516	1,741	1,863	2,161	1,671	
42 x 90	Static	08TC4290Y36	1,591	1,846	1,959	2,231	1,692	
42 x 96	Static	08TC4296Y36	1,591	1,846	1,973	2,304	1,702	
48 x 60	Static	08TC4860Y36	1,415	1,600	1,711	1,961	1,630	
48 x 72	Static	08TC4872Y36	1,508	1,729	1,840	2,115	1,761	
48 x 84	Static	08TC4884Y36	1,516	1,741	1,877	2,265	1,782	
48 x 90	Static	08TC4890Y36	1,592	1,847	1,974	2,342	1,824	
48 x 96	Static	08TC4896Y36	1,592	1,847	1,988	2,419	1,835	

Top Size	Base	Model Number	3P	3K	3W	W1-W4	F1-F5	Rectangle with Y & T-bases
42 x 120	Static	08TC42120Y36T36	\$ 2,214	\$ 2,593	\$ 2,682	\$ 2,898	2,696	 
42 x 144	Static	08TC42144Y36T36	2,369	2,810	2,908	3,179	2,717	
48 x 120	Static	08TC48120Y36T36	2,223	2,606	2,707	3,036	2,749	
48 x 144	Static	08TC48144Y36T36	2,380	2,825	2,935	3,337	2,802	

3 bases: **SH** **LC**  
+195 +135

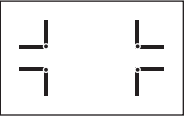

LC +90
OS NA
CH NA
WM +125
WMLC +45
SH T+130 TT+260
FR NA
PB NA
GR +40
CM +50
RC +55
GN +40
LT +115
AH T+250

NEW

Rectangular with L-bases	Top Size	Base	Model Number	3P	3K	3W	W1-W4	F1-F5
 	54 x 60	Static	08TC5460L26	\$ 1,881	\$2,086	\$ 2,195	\$2,459	NA
	54 x 72	Static	08TC5472L26	1,984	2,230	2,336	2,621	NA
	54 x 84	Static	08TC5484L26	2,086	2,374	2,477	2,786	NA
	54 x 90	Static	08TC5490L26	2,138	2,446	2,547	2,867	NA
	54 x 96	Static	08TC5496L26	2,189	2,518	2,618	2,948	NA
	60 x 72	Static	08TC6072L26	2,052	2,326	2,425	2,717	NA
	60 x 84	Static	08TC6084L26	2,166	2,486	2,579	2,890	NA
	60 x 90	Static	08TC6090L26	2,223	2,566	2,656	2,979	NA
	60 x 96	Static	08TC6096L26	2,281	2,646	2,732	3,064	NA

3 bases: **SH** **LC**  
+195 +135

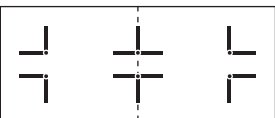
NEW

Rectangular with L & Y-bases	Top Size	Base	Model Number	3P	3K	3W	W1-W4	F1-F5
 	54 x 120	Static	08TC54120L26Y26	\$3,304	\$3,777	\$3,824	\$ 4,173	NA
	54 x 144	Static	08TC54144L26Y26	3,509	4,065	4,105	4,500	NA
	60 x 120	Static	08TC60120L26Y26	3,418	3,937	3,963	4,311	NA
	60 x 144	Static	08TC60144L26Y26	3,647	4,257	4,270	4,657	NA

6 bases: **SH** **LC**  
quote +270

Elite

- LC**  
+90
- OS**  
NA
- CH**  
NA
- WM**  
+125
- WMLC**  
+45
- SH**  
NA
- FR**  
NA
- PB**  
NA
- GR**  
+40
- CM**  
+50
- RC**  
+55
- GN**  
+40
- LT**  
+115
- AH**  
NA

Top Size	Base	Model Number	3P	3K	3W	W1-W4	F1-F5	Boat-Shaped with T-bases
30 x 42 x 84	Static	08BT3084T26	\$ 1,352	\$ 1,657	\$ 1,678	\$ 2,397	\$ 1,422	
30 x 42 x 90	Static	08BT3090T26	1,460	1,809	1,811	2,497	1,447	
30 x 42 x 96	Static	08BT3096T26	1,460	1,809	1,824	2,593	1,460	

Top Size	Base	Model Number	3P	3K	3W	W1-W4	F1-F5	Boat-Shaped with Y-bases
36 x 48 x 84	Static	08BT3684Y26	\$ 1,752	\$ 2,100	\$ 2,096	\$ 2,832	\$ 1,742	
36 x 48 x 90	Static	08BT3690Y26	1,875	2,273	2,246	2,936	1,795	
36 x 48 x 96	Static	08BT3696Y26	1,875	2,273	2,259	3,036	1,807	





Top Size	Base	Model Number	3P	3K	3W	W1-W4	F1-F5	Boat-Shaped with Y & T-bases
36 x 48 x 120	Static	08BT36120Y26T32	\$ 2,561	\$ 3,119	\$ 3,041	\$ 3,730	2,644	
36 x 48 x 144	Static	08BT36144Y26T32	2,808	3,464	3,367	4,141	2,697	



3 bases: **SH** **LC**  
+195 +135



Top Size	Base	Model Number	3P	3K	3W	W1-W4	F1-F5	Boat-Shaped with L & Y-bases
48 x 54 x 120	Static	08BT48120L26Y26	\$ 3,669	\$ 4,289	\$ 4,172	\$ 5,008	NA	
48 x 54 x 144	Static	08BT48144L26Y26	3,948	4,679	4,535	5,435	NA	
54 x 60 x 120	Static	08BT54120L26Y26	3,824	4,505	4,351	5,181	NA	
54 x 60 x 144	Static	08BT54144L26Y26	4,134	4,939	4,747	5,631	NA	



6 bases: **SH** **LC**  
quote +270

- LC**  
+90
- OS**  
NA
- CH**  
NA
- WM**  
+125
- WMLC**  
+45
- SH**  
T+130
- FR**  
NA
- PB**  
NA
- GR**  
+40
- CM**  
+50
- RC**  
NA
- GN**  
NA
- LT**  
NA
- AH**  
T+250

Racetrack with T-bases	Top Size	Base	Model Number	3P	3K	3W	W1-W4	F1-F5
    <p>Folding T Nesting T</p>	36 x 60	Static	08RT3660T26	\$ 993	\$ 1,183	\$ 1,227	\$ 1,825	\$ 1,180
		Nesting	08RT3660T26NE	1,597	1,782	1,825	NA	1,855
	36 x 72	Static	08RT3672T26	1,084	1,309	1,354	2,005	1,325
		Folding	08RT3672T26FD	1,347	1,573	1,617	2,269	1,602
		Nesting	08RT3672T26NE	1,740	1,961	2,005	NA	2,055
	36 x 84	Static	08RT3684T26	1,247	1,510	1,554	2,258	1,422
		Folding	08RT3684T26FD	1,442	1,705	1,749	2,454	1,627
	36 x 90	Static	08RT3690T26	1,369	1,681	1,702	2,351	1,435
		Folding	08RT3690T26FD	1,564	1,876	1,897	2,546	1,640
	36 x 96	Static	08RT3696T26	1,369	1,681	1,716	2,439	1,441
		Folding	08RT3696T26FD	1,564	1,876	1,911	2,634	1,646

Racetrack with Y-bases	Top Size	Base	Model Number	3P	3K	3W	W1-W4	F1-F5
 	42 x 84	Static	08RT4284Y32	\$ 1,689	\$ 1,994	\$ 2,015	\$ 2,736	\$ 1,779
	42 x 90	Static	08RT4290Y32	1,800	2,149	2,150	2,837	1,804
	42 x 96	Static	08RT4296Y32	1,800	2,149	2,164	2,933	1,817
	48 x 84	Static	08RT4884Y36	1,947	2,345	2,304	2,904	1,818
	48 x 90	Static	08RT4890Y36	1,947	2,345	2,318	3,008	1,869
	48 x 96	Static	08RT4896Y36	1,947	2,345	2,332	3,108	1,881

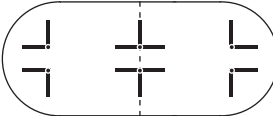
Racetrack with Y & T-bases	Top Size	Base	Model Number	3P	3K	3W	W1-W4	F1-F5
  <p>3 bases: <b>SH</b> <b>LC</b> +195 +135</p>	42 x 120	Static	08RT42120Y32T32	\$ 2,595	\$ 3,147	\$ 3,065	\$ 3,603	2,641
	42 x 144	Static	08RT42144Y32T32	2,839	3,489	3,389	3,992	2,662
	48 x 120	Static	08RT48120Y36T36	2,661	3,219	3,141	3,829	2,749
	48 x 144	Static	08RT48144Y36T36	2,908	3,564	3,467	4,241	2,802

Boat-Shaped with L & Y-bases	Top Size	Base	Model Number	3P	3K	3W	W1-W4	F1-F5
  <p>6 bases: <b>SH</b> <b>LC</b> quote +270</p>	54 x 120	Static	08BT54120L26Y26	\$ 3,670	\$ 4,289	\$ 4,173	\$ 5,008	NA
	54 x 144	Static	08BT54144L26Y26	3,949	4,680	4,535	5,435	NA
	60 x 120	Static	08BT60120L26Y26	3,825	4,506	4,351	5,181	NA
	60 x 144	Static	08BT60144L26Y26	4,135	4,940	4,748	5,631	NA



- LC**  
+90
- OS**  
NA
- CH**  
NA
- WM**  
+125
- WMLC**  
+45
- SH**  
T+130
- FR**  
NA
- PB**  
NA
- GR**  
+40
- CM**  
+50
- RC**  
NA
- GN**  
NA
- LT**  
NA
- AH**  
T+250

Top Size	Base	Model Number	3P	3K	3W	W1-W4	F1-F5	Elliptical with T-bases
30 x 54	Static	08EL3054T22	\$ 867	\$ 1,010	\$ 1,055	\$ 1,612	\$ 944	
30 x 60	Static	08EL3060T22	905	1,062	1,107	1,696	968	
36 x 60	Static	08EL3660T26	993	1,183	1,215	1,825	1,074	
36 x 72	Static	08EL3672T26	1,084	1,309	1,336	2,005	1,195	
36 x 84	Static	08EL3684T26	1,247	1,510	1,530	2,258	1,288	
36 x 90	Static	08EL3690T26	1,369	1,681	1,675	2,351	1,334	
36 x 96	Static	08EL3696T26	1,369	1,681	1,686	2,439	1,359	

Top Size	Base	Model Number	3P	3K	3W	W1-W4	F1-F5	Elliptical with Y-bases
42 x 72	Static	08EL4272Y26	\$ 1,471	\$ 1,735	\$ 1,744	\$ 2,429	1,502	
42 x 84	Static	08EL4284Y26	1,642	1,947	1,947	2,689	1,595	
42 x 90	Static	08EL4290Y26	1,755	2,104	2,082	2,789	1,616	
42 x 96	Static	08EL4296Y26	1,755	2,104	2,092	2,886	1,627	
48 x 72	Static	08EL4872Y26	1,593	1,906	1,889	2,560	1,614	
48 x 84	Static	08EL4884Y26	1,673	1,990	1,992	2,832	1,706	
48 x 90	Static	08EL4890Y26	1,876	2,274	2,225	2,936	1,749	
48 x 96	Static	08EL4896Y26	1,876	2,274	2,236	3,036	1,759	



Top Size	Base	Model Number	3P	3K	3W	W1-W4	F1-F5	Elliptical with Y & T-bases
42 x 120	Static	08EL42120Y26T32	\$ 2,548	\$ 3,100	\$ 2,979	\$ 3,556	2,591	
42 x 144	Static	08EL42144Y26T32	2,792	3,442	3,291	3,945	2,613	
48 x 120	Static	08EL48120Y26T32	2,562	3,119	3,006	3,730	2,644	
48 x 144	Static	08EL48144Y26T32	2,808	3,465	3,320	4,141	2,697	

3 bases: SH LC  
+195 +135



Square with X-base		Top Size	Base	Model Number	3P	3K	3W	W1-W4	F1-F5
 	24 x 24	Static	08SQ2424X22	\$ 522	\$ 560	\$ 642	\$ 772	\$ 574	
		Flip Top	08SQ2424X22FT	648	686	768	898	706	
	30 x 30	Static	08SQ3030X26	584	643	737	894	641	
		Flip Top	08SQ3030X26FT	710	769	863	1,020	773	
	36 x 36	Static	08SQ3636X32	669	753	856	1,040	814	
		Flip Top	08SQ3636X32FT	795	879	982	1,166	946	
42 x 42	Static	08SQ4242X36	756	869	978	1,189	850		
	Flip Top	08SQ4242X36FT	882	995	1,104	1,315	982		

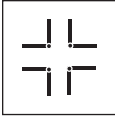

Flip Top X

Square with L-bases		Top Size	Base	Model Number	3P	3K	3W	W1-W4	F1-F5
 	48 x 48	Static	08SQ4848L26	\$ 1,666	\$ 1,813	\$ 1,924	\$ 2,157	\$ 1,738	
	54 x 54	Static	08SQ5454L26	1,761	1,946	2,057	2,310	NA	
	60 x 60	Static	08SQ6060L26	1,867	2,095	2,201	2,476	NA	

4 bases: **SH** **LC**  
+260 +180

Square with TT-bases		Top Size	Base	Model Number	3P	3K	3W	W1-W4	F1-F5
 	48 x 48	Static	08SQ4848TT32	\$ 1,211	\$ 1,358	\$ 1,470	\$ 1,702	\$ 1,260	
		Nesting	08SQ4848TT32NE	1,986	2,130	2,239	NA	2,118	



Nesting TT

- LC**  
+90
- OS**  
NA
- CH**  
NA
- WM**  
+125
- WMLC**  
+45
- SH**  
X+65  
TT+260
- FR**  
+150
- PB**  
X+90
- GR**  
+40
- CM**  
+50
- RC**  
+55
- GN**  
+40
- LT**  
+115
- AH**  
X+125

Elite



Top Size	Base	Model Number	3P	3K	3W	W1-W4	F1-F5	Round with X-base
24 x 24	Static	08RD24X22	\$ 553	\$ 604	\$ 653	\$ 980	\$ 574	
	Flip Top	08RD24X22FT	679	730	779	1,106	706	
30 x 30	Static	08RD30X26	634	713	762	1,171	641	
	Flip Top	08RD30X26FT	760	839	888	1,297	773	
36 x 36	Static	08RD36X32	731	839	888	1,394	814	
	Flip Top	08RD36X32FT	856	965	1,014	1,520	946	
42 x 42	Static	08RD42X32	828	976	1,017	1,614	835	
	Flip Top	08RD42X32FT	954	1,101	1,143	1,740	967	
48 x 48	Static	08RD48X36	869	1,028	1,083	1,866	871	





Top Size	Base	Model Number	3P	3K	3W	W1-W4	F1-F5	Round with L-bases
54 x 54	Static	08RD54L26	\$ 1,544	\$ 1,766	\$ 1,795	\$ 2,643	NA	
60 x 60	Static	08RD60L26	1,566	1,797	1,841	2,920	NA	

3 bases: **SH** +195 **LC** +135

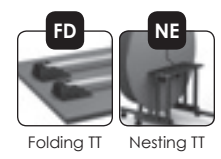
Top Size	Base	Model Number	3P	3K	3W	W1-W4	F1-F5	Round with TT-base
48 x 48	Static	08RD48TT32	\$ 1,240	\$ 1,398	\$ 1,475	\$ 2,237	1,260	
	Nesting	08RD48TT32NE	2,014	2,170	2,245	NA	2,118	
54 x 54	Static	08RD54TT32	1,399	1,622	1,651	2,499	NA	
	Nesting	08RD54TT32NE	2,171	2,389	2,417	NA	NA	
60 x 60	Static	08RD60TT32	1,422	1,653	1,697	2,776	NA	
	Folding	08RD60TT32FD	2,004	2,235	2,280	NA	NA	
	Nesting	08RD60TT32NE	2,192	2,419	2,462	NA	NA	



- LC**  
+90
- OS**  
NA
- CH**  
NA
- WM**  
+125
- WMLC**  
+45
- SH**  
X+65  
TT+260
- FR**  
+150
- PB**  
X+90
- GR**  
+40
- CM**  
+50
- RC**  
NA
- GN**  
NA
- LT**  
NA
- AH**  
X+125

D-shaped with T-bases	Top Size	Base	Model Number	3P	3K	3W	W1-W4	F1-F5
	24 x 36	Static	08D2436T22	\$ 698	\$ 773	\$ 844	\$ 1,134	\$ 752
		Nesting	08D2436T22NE	1,121	1,194	1,263	NA	1,215
	24 x 48	Static	08D2448T22	761	861	940	1,269	825
		Nesting	08D2448T22NE	1,182	1,280	1,358	NA	1,286
	24 x 60	Static	08D2460T22	823	948	1,037	1,404	898
		Nesting	08D2460T22NE	1,271	1,393	1,480	NA	1,387
	24 x 72	Static	08D2472T22	886	1,036	1,133	1,538	971
		Nesting	08D2472T22NE	1,426	1,573	1,668	NA	1,582
 Nesting T	24 x 84	Static	08D2484T22	1,017	1,192	1,298	1,741	1,116
		Nesting	08D2484T22NE	1,627	1,799	1,903	NA	1,800
	24 x 90	Static	08D2490T22	1,048	1,235	1,346	1,810	1,152
		Nesting	08D2490T22NE	1,658	1,842	1,950	NA	1,836
	24 x 96	Static	08D2496T22	1,079	1,279	1,394	1,880	1,189
		Nesting	08D2496T22NE	1,688	1,885	1,997	NA	1,872
	30 x 48	Static	08D3048T26	833	958	1,029	1,374	908
		Nesting	08D3048T26NE	1,252	1,375	1,445	NA	1,367
	30 x 60	Static	08D3060T26	911	1,067	1,143	1,521	977
		Nesting	08D3060T26NE	1,356	1,509	1,584	NA	1,464
	30 x 72	Static	08D3072T26	989	1,176	1,256	1,667	1,090
		Nesting	08D3072T26NE	1,527	1,710	1,789	NA	1,698
	30 x 84	Static	08D3084T26	1,135	1,354	1,438	1,881	1,253
		Nesting	08D3084T26NE	1,743	1,958	2,041	NA	1,935
	30 x 90	Static	08D3090T26	1,174	1,408	1,495	1,954	1,298
		Nest/Lightwt	08D3090T26NE-LT	1,857	NA	NA	NA	NA
	30 x 96	Static	08D3096T26	1,213	1,463	1,552	2,027	1,344
		Nest/Lightwt	08D3096T26NE-LT	1,933	NA	NA	NA	NA
	36 x 48	Static	08D3648T26	895	1,045	1,109	1,471	981
		Nesting	08D3648T26NE	1,314	1,461	1,523	NA	1,439
	36 x 60	Static	08D3660T26	989	1,176	1,239	1,628	1,090
		Nesting	08D3660T26NE	1,554	1,738	1,800	NA	1,702
	36 x 72	Static	08D3672T26	1,083	1,307	1,370	1,782	1,195
		Nesting	08D3672T26NE	1,739	1,959	2,021	NA	1,927
	36 x 84	Static	08D3684T26	1,244	1,507	1,569	2,008	1,288
		Nest/Lightwt	08D3684T26NE-LT	1,964	NA	NA	NA	NA
	36 x 90	Static	08D3690T26	1,291	1,573	1,635	2,089	1,441
		Nest/Lightwt	08D3690T26NE-LT	2,010	NA	NA	NA	NA
	36 x 96	Static	08D3696T26	1,338	1,638	1,700	2,166	1,452
		Nest/Lightwt	08D3696T26NE-LT	2,056	NA	NA	NA	NA

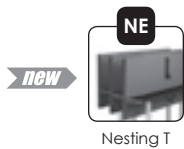

Elite

- LC**  
+90
- OS**  
+70
- CH**  
NA
- WM**  
+125
- WMLC**  
+45
- SH**  
T+130
- FR**  
NA
- PB**  
NA
- GR**  
+40
- CM**  
+50
- RC**  
+55
- GN**  
+40
- LT**  
NA
- AH**  
T+250

Top Size	Base	Model Number	3P	3K	3W	W1-W4	F1-F5	D-shaped with TT-bases
42 x 60	Static	08D4260TT32	\$ 1,391	\$ 1,609	\$ 1,660	\$ 2,056	\$ 1,521	
	Nesting	08D4260TT32NE	2,162	2,376	2,426	NA	2,374	
42 x 72	Static	08D4272TT32	1,500	1,762	1,808	2,225	1,535	
	Nesting	08D4272TT32NE	2,269	2,527	2,571	NA	2,388	
48 x 60	Static	08D4860TT32	1,469	1,719	1,757	2,164	1,612	
	Nesting	08D4860TT32NE	2,239	2,484	2,521	NA	2,464	
48 x 72	Static	08D4872TT32	1,594	1,894	1,922	2,341	1,646	
	Nesting	08D4872TT32NE	2,361	2,655	2,683	NA	2,497	

Top Size	Base	Model Number	3P	3K	3W	W1-W4	F1-F5	D-shaped with Y & T-bases
42 x 60	Static	08D4260Y32T32	\$ 1,292	\$ 1,510	\$ 1,561	\$ 1,957	\$ 1,417	
42 x 72	Static	08D4272Y32T32	1,401	1,663	1,709	NA	1,431	
42 x 84	Static	08D4284Y32T32	1,679	2,025	2,036	2,360	1,523	
42 x 90	Static	08D4290Y32T32	1,741	2,112	2,118	2,444	1,545	
42 x 96	Static	08D4296Y32T32	1,803	2,199	2,200	2,529	1,688	
48 x 60	Static	08D4860Y36T36	1,410	1,659	1,698	2,104	1,550	
48 x 72	Static	08D4872Y36T36	1,535	1,834	1,863	2,281	1,584	
48 x 84	Static	08D4884Y36T36	1,728	2,078	2,096	2,530	1,677	
48 x 90	Static	08D4890Y36T36	1,790	2,165	2,179	2,707	1,719	
48 x 96	Static	08D4896Y36T36	1,853	2,253	2,261	2,707	1,730	



Top Size	Base	Model Number	3P	3K	3W	W1-W4	F1-F5	D-shaped with L-bases
54 x 54	Static	08D5454L26	\$ 2,072	\$ 2,381	\$ 2,372	\$ 2,634	\$ NA	<div style="border: 1px solid gray; padding: 5px; margin-top: 10px;">                     4 bases: <b>SH</b> <b>LC</b> <b>LC</b>                      +260 +180 +180                 </div>
54 x 60	Static	08D5460L26	2,080	2,392	2,380	2,834	NA	
54 x 72	Static	08D5472L26	2,142	2,480	2,491	2,915	NA	
54 x 84	Static	08D5484L26	2,351	2,745	2,741	3,171	NA	
54 x 90	Static	08D5490L26	2,421	2,843	2,832	3,267	NA	
54 x 96	Static	08D5496L26	2,491	2,941	2,923	3,360	NA	
60 x 60	Static	08D6060L26	2,080	2,392	2,405	2,834	NA	
60 x 72	Static	08D6072L26	2,260	2,645	2,632	3,030	NA	
60 x 84	Static	08D6084L26	2,460	2,898	2,872	3,298	NA	
60 x 90	Static	08D6090L26	2,538	3,007	2,972	3,398	NA	
60 x 96	Static	08D6096L26	2,616	3,116	3,072	3,498	NA	



Top Size	Base	Model Number	3P	3K	3W	W1-W4	F1-F5	D-shaped with L & Y-bases
54 x 120	Static	08D54120L26Y26	\$ 3,682	\$ 4,306	\$ 4,213	\$ 4,638	NA	<div style="border: 1px solid gray; padding: 5px; margin-top: 10px;">                     6 bases: <b>SH</b> <b>LC</b>                      quote +270                 </div>
54 x 144	Static	08D54144L26Y26	3,963	4,699	4,577	5,015	NA	
60 x 120	Static	08D60120L26Y26	3,838	4,524	4,395	4,800	NA	
60 x 144	Static	08D60144L26Y26	4,150	4,962	4,794	5,196	NA	



online updates
new product
clarification / edit
deletion



Elite

- LC**  
+90
- OS**  
+70
- CH**  
NA
- WM**  
+125
- WMC**  
+45
- SH**  
T+130  
TT+260
- FR**  
NA
- PB**  
NA
- GR**  
+40
- CM**  
+50
- RC**  
+55
- GN**  
+40
- LT**  
NA
- AH**  
T+250

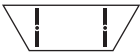
Half Round with T-bases	Top Size	Base	Model Number	3P	3K	3W	W1-W4	F1-F5
   <p>Nesting T</p>	24 x 48	Static	08HR2448T18	\$ 764	\$ 865	\$ 932	\$ 1,585	\$ 825
		Nesting	08HR2448T18NE	1,185	1,284	1,349	NA	1,286
	30 x 60	Static	08HR3060T22	903	1,060	1,120	1,904	989
		Nesting	08HR3060T22NE	1,321	1,475	1,534	NA	1,447
	36 x 72	Static	08HR3672T26	1,081	1,306	1,351	2,259	1,200
		Nesting	08HR3672T26NE	1,683	1,903	1,947	NA	1,810

Crescent with T-bases	Top Size	Base	Model Number	3P	3K	3W	W1-W4	F1-F5
 	24 x 48 x 75	Static	08CS2475T22	\$ 1,306	\$ 1,624	\$ 1,571	\$ 1,908	\$ 1,676
	24 x 60 x 94	Static	08CS2494T22	1,629	2,076	1,976	2,185	1,676
	30 x 60 x 94	Static	08CS3094T26	1,638	2,085	1,982	2,352	1,686

Trapezoid with T-bases	Top Size	Base	Model Number	3P	3K	3W	W1-W4	F1-F5
   <p>Nesting T</p>	24 x 48	Static	08TZ2448T18	\$ 755	\$ 853	\$ 918	\$ 1,365	\$ 825
	24 x 72	Static	08TZ2472T18	914	1,076	1,149	1,704	971
		Nesting	08TZ2472T18NE	1,360	1,518	1,589	NA	1,458
	30 x 60	Static	08TZ3060T22	862	1,002	1,070	1,673	989
		Nesting	08TZ3060T22NE	1,281	1,418	1,485	NA	1,447
	36 x 72	Static	08TZ3672T26	1,059	1,275	1,321	2,025	1,200
	Nesting	08TZ3672T26NE	1,634	1,845	1,890	NA	1,846	

Corner with T-bases	Top Size	Base	Model Number	3P	3K	3W	W1-W4	F1-F5
 	24 x 42	Static	08CR2442T32	\$ 1,050	\$ 1,218	\$ 1,277	\$ 1,934	913
	30 x 48	Static	08CR3048T36	1,137	1,318	1,395	2,262	1,080

- LC  
+90
- OS  
+70
- CH  
NA
- WM  
+125
- WMLC  
+45
- SH  
T+130
- FR  
NA
- PB  
NA
- GR  
+40
- CM  
+50
- RC  
+55
- GN  
+40
- LT  
NA
- AH  
T+250

Elite

Top Size	Base	Model Number	3P	3K	3W	W1-W4	F1-F5	Arc Segment with T-bases
20 x 44	Static	08AS2044T18	\$ 789	\$ 900	\$ 932	\$ NA	757	
24 x 51	Static	08AS2451T18	858	997	1,025	NA	850	
30 x 59	Static	08AS3059T26	937	1,103	1,135	NA	999	
36 x 67	Static	08AS3667T26	1,103	1,336	1,359	NA	1,200	

Top Size	Base	Model Number	3P	3K	3W	W1-W4	F1-F5	Ganging Quarter Round (with T-base)
20 x 20	Ganging	QR2020GN	\$ 224	\$ 272	\$ 319	NA	\$ 236	
24 x 24	Ganging	QR2424GN	233	284	344	NA	236	
30 x 30	Static, GN	08QR3030GNT26	532	611	676	NA	535	
	Ganging	QR3030GN	301	380	444	NA	292	
36 x 36	Static, GN	08QR3636GNT26	596	701	771	NA	684	
	Ganging	QR3636GN	365	469	540	NA	442	

1 base: **LC** **OS** **SH**  
 NA +35 +65



Top Size	Base	Model Number	3P	3K	3W	W1-W4	F1-F5	Ganging 45° Wedge (with T-base)
20 x 20	Ganging	WG45D20GN	\$ 224	\$ 272	\$ 315	NA	\$ 236	
24 x 24	Ganging	WG45D24GN	233	284	337	NA	236	
30 x 30	Ganging	WG45D30GN	301	380	432	NA	292	
36 x 36	Static, GN	08WG45D36GNT26	596	701	752	NA	684	
	Ganging	WG45D36GN	365	469	520	NA	442	

1 base: **LC** **OS** **SH**  
 NA +35 +65







Top Size	Base	Model Number	3P	3K	3W	W1-W4	F1-F5	Ganging 60° Wedge (with T-base)
20 x 20	Ganging	WG60D20GN	\$ 246	\$ 302	\$ 343	NA	\$ 236	
24 x 24	Ganging	WG60D24GN	254	314	366	NA	236	
30 x 30	Static, GN	08WG60D30GNT26	554	641	693	NA	535	
	Ganging	WG60D30GN	322	410	462	NA	292	
36 x 36	Static, GN	08WG60D36GNT26	618	730	784	NA	684	
	Ganging	WG30D36GN	386	499	553	NA	442	



1 base: **LC** **OS** **SH**  
 NA +35 +65





- LC**  
+90
- OS**  
+70
- CH**  
NA
- WM**  
+125
- WMLC**  
+45
- SH**  
T+130
- FR**  
NA
- PB**  
NA
- GR**  
+40
- CM**  
+50
- RC**  
+55
- GN**  
+40
- LT**  
NA
- AH**  
T+250



Video Wedge with T-bases	Top Size	Base	Model Number	3P	3K	3W	W1-W4	F1-F5
 	20 x 20 x 40	Static	08VW2040T18	\$ 746	\$ 840	\$ 900	NA	\$ 736
	24 x 24 x 48	Static	08VW2448T18	789	900	972	NA	825
	30 x 30 x 60	Static	08VW3060T26	937	1,103	1,173	NA	999
	36 x 36 x 72	Static	08VW3672T26	1,186	1,453	1,487	NA	1,200

10° Transition with T-bases	Top Size	Base	Model Number	3P	3K	3W	W1-W4	F1-F5
 	20 x 30	Static	08TN2030T18	\$ 650	\$ 705	\$ 771	NA	\$ 686
	24 x 30	Static	08TN2430T18	661	720	791	NA	716
	30 x 30	Static	08TN3030T26	725	807	873	NA	771
	36 x 30	Static	08TN3630T26	789	897	955	NA	817

Trident with XY-base	Top Size	Base	Model Number	3P	3K	3W	W1-W4	F1-F5
 	40 x 40 x 20	Static	08TR4020XY32	\$ 1,045	\$ 1,280	\$ 1,246	\$ 1,594	\$ 1,085

Trident with 3 Offset T-bases	Top Size	Base	Model Number	3P	3K	3W	W1-W4	F1-F5
 	48 x 48 x 24	Static	08TR4824TOS18	\$ 1,446	\$ 1,686	\$ 1,676	\$ 2,256	\$ 1,492
	60 x 60 x 30	Static	08TR6030TOS18	1,634	1,948	1,925	2,691	NA

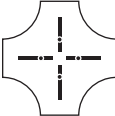

3 bases: **SH** **LC**  
+195 +135



Quadrant with 4 Offset T-bases	Top Size	Base	Model Number	3P	3K	3W	W1-W4	F1-F5
 	60 x 60 x 20	Static	08QD6020TOS18	\$ 1,940	\$ 2,272	\$ 2,261	\$ 3,111	NA
	60 x 60 x 24	Static	08QD6024TOS18	1,940	2,272	2,265	3,111	NA
	60 x 60 x 30	Static	08QD6030TOS18	1,940	2,272	2,270	3,111	NA



4 bases: **SH** **LC**  
+260 +180



Elite

- LC**  
+90
- OS**  
+70
- CH**  
NA
- WM**  
+125
- WMLC**  
+45
- SH**  
T+130
- FR**  
NA
- PB**  
XY+90
- GR**  
+40
- CM**  
+50
- RC**  
+55
- GN**  
+40
- LT**  
NA
- AH**  
T+250

Top Size	Base	Model Number	3P	3K	3W	W1-W4	F1-F5	Bulb with X-base
30 x 30 x 20	Static	08BU3020X26	\$ 803	\$ 949	\$ 954	\$ 1,614	\$ 683	 
36 x 36 x 24	Static	08BU3624X32	931	1,120	1,116	1,902	808	
42 x 42 x 30	Static	08BU4230X32	1,028	1,256	1,245	2,187	926	
48 x 48 x 36	Static	08BU4836X36	1,055	1,288	1,296	2,489	1,077	

Top Size	Base	Model Number	3P	3K	3W	W1-W4	F1-F5	Squire with X-base	NEW
24 x 24	Static	08SL24X22	\$ 707	\$ 819	\$ 846	\$ NA	\$ 574	 	
	Flip Top	08SL24X22FT	833	945	971	NA	706		
30 x 30	Static	08SL30X26	766	898	937	NA	641		
	Flip Top	08SL30X26FT	892	1,024	1,063	NA	773		
36 x 36	Static	08SL36X32	843	996	1,047	NA	814		
	Flip Top	08SL36X32FT	969	1,122	1,173	NA	946		
42 x 42	Static	08SL42X36	916	1,093	1,154	NA	850		
	Flip Top	08SL42X36FT	1,041	1,218	1,280	NA	982		

Top Size	Base	Model Number	3P	3K	3W	W1-W4	F1-F5	Teardrop with X-base
24 x 48	Static	08TE2448X3236	\$ 797	\$ 965	\$ 1,025	NA	686	 

Top Size	Base	Model Number	3P	3K	3W	W1-W4	F1-F5	Table Desk with T-bases
37 x 60	Static	08TA3760T26	\$ 983	\$ 1,168	\$ 1,276	\$ 1,967	\$ 1,105	 
42 x 78	Static	08TA4278T32	1,415	1,702	1,792	2,568	1,623	

- LC**  
+90
- OS**  
+70
- CH**  
NA
- WM**  
+125
- WMLC**  
+45
- SH**  
X+65  
T+130
- FR**  
NA
- PB**  
X+90
- GR**  
+40
- CM**  
+50
- RC**  
+55
- GN**  
+40
- LT**  
NA
- AH**  
T+250



Light weight aluminum construction makes Element a great folding solution. Pair it up with TableX light weight tops to create tables that are much easier to handle than standard product.

## Element Base Styles



## Element Base Options

standard plastic glides



locking casters



concealed casters



**LC Locking Casters**  
can be added to any table for \$90.

**CCG Concealed Casters**  
available on one T-base for \$120 per table. Standard glides on opposite base.

**FD Folding Bases**  
priced accordingly with standard glides.

**NE Nesting Tables**  
priced accordingly with locking casters.

**FT Flip Tops**  
available on X-based tables and are priced with standard glides.

**OS Offset Bases**  
available for \$35.

**CH Chrome Finish**  
is not available on Element tables.

**WM Wire Management**  
Built in wire management is not available on Element tables.

**WMLC Wire Management Leg Covers**  
are compatible with Element X and 4-column X-bases. They are not compatible with Element T or TT-bases.

**SH Special Height**  
of can be added to any table:  
+ \$65 per column for heights > 29"  
+ \$35 per column for heights < 29"  
Special height tables larger than 36x72" must be custom quoted.

**FR Footring**  
is not available on Element series.

**PB Power Box Mounting Plate**  
is not available on Element tables.



online updates

new product

clarification / edit

deletion



## Element Height Adjustable Options

- NU Pneumatic**  
is not available on Element tables.
- AH Spring Clip**  
is not available on Element tables.
- RA Ratchet**  
is not available on Element bases.
- BL Counterbalanced**  
is not available on Element bases.

## Element Top Shapes

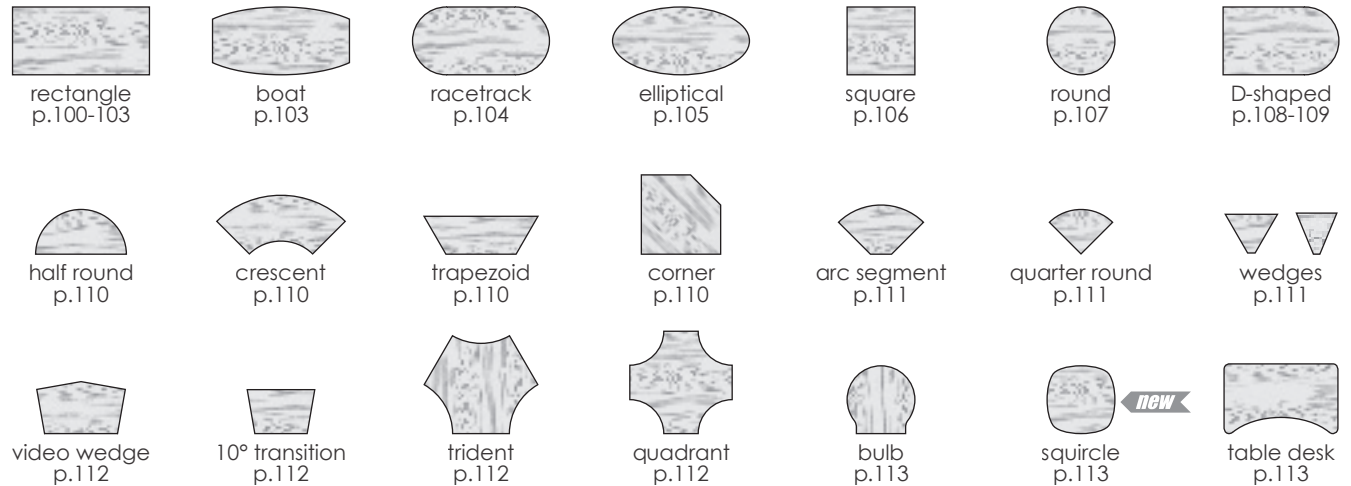



## Element Top Options

- RC 3" Radius Corners**  
can be added to any table for \$55.
- LT Lightweight Tops**  
can be added to any square or rectangular table for \$115. This is a great option when specifying folding tables.
- GR Grommets**  
can be added to any table for \$40 each. To see specific locations, see page 203.
- GN Ganging Brackets**  
can be added to most table shapes for \$40.
- CM Cable Manager**  
can be added to any table for \$50 each. To see specific locations, see page 203.

## Element Edge Options

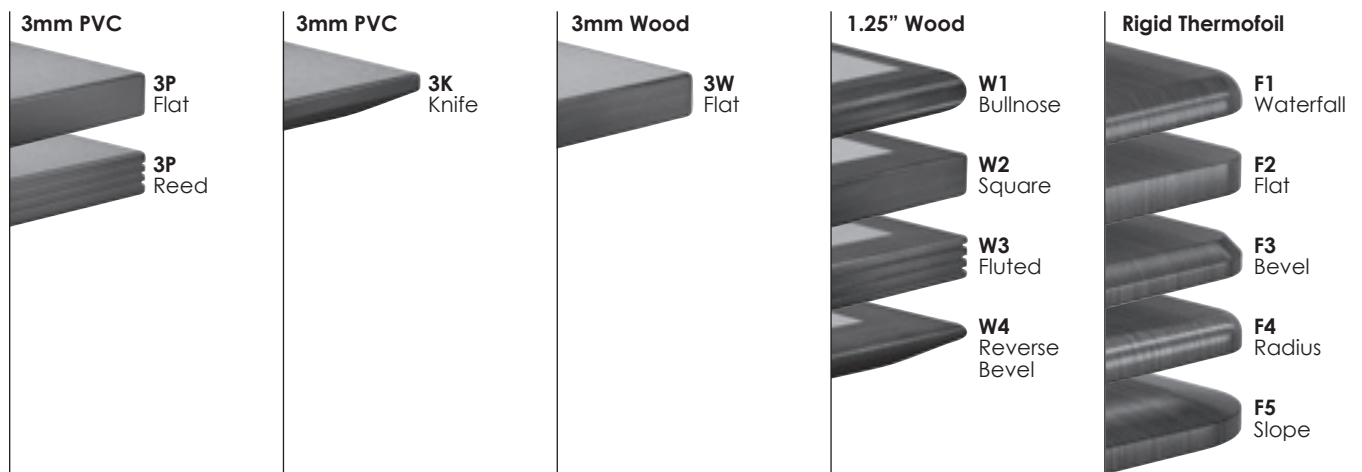

(correspond with 5 columns of pricing)







Rectangular with T-bases	Top Size	Base	Model Number	3P	3K	3W	W1-W4	F1-F5
    <p>Folding T    Nesting T</p>	18 x 36	Static	33TC1836T16	\$ 508	\$ 551	\$ 644	\$ 793	\$ 557
		Nesting	33TC1836T18NE	934	976	1,067	NA	1,023
		18 x 48	Static	33TC1848T16	543	600	710	889
	Folding		33TC1848T16FD	796	853	963	1,142	848
	Nesting		33TC1848T18NE	996	1,052	1,159	NA	1,077
	18 x 60	Static	33TC1860T16	578	649	776	989	648
		Folding	33TC1860T16FD	842	913	1,040	1,253	925
		Nesting	33TC1860T18NE	1,086	1,156	1,280	NA	1,200
	18 x 72	Static	33TC1872T16	613	698	842	1,089	740
		Folding	33TC1872T16FD	876	962	1,106	1,353	1,017
		Nesting	33TC1872T18NE	1,298	1,382	1,523	NA	1,502
	18 x 84	Static	33TC1884T16	716	815	977	1,257	834
		Folding	33TC1884T16FD	912	1,011	1,172	1,453	1,039
		Nesting	33TC1884T18NE	1,333	1,430	1,588	NA	1,524
	18 x 90	Static	33TC1890T16	751	864	1,029	1,307	834
		Folding	33TC1890T16FD	946	1,059	1,224	1,503	1,039
		Nesting	33TC1890T18NE	1,367	1,478	1,639	NA	1,524
	18 x 96	Static	33TC1896T16	751	864	1,043	1,353	845
Folding		33TC1896T16FD	946	1,059	1,238	1,549	1,050	
Nesting		33TC1896T18NE	1,367	1,478	1,653	NA	1,535	
20 x 36	Static	33TC2036T18	542	599	686	812	576	
	Nesting	33TC2036T18NE	968	1,023	1,108	NA	1,042	
20 x 48	Static	33TC2048T18	588	663	764	916	594	
	Folding	33TC2048T18FD	841	916	1,017	1,169	860	
	Nesting	33TC2048T18NE	1,040	1,113	1,212	NA	1,088	
20 x 60	Static	33TC2060T18	609	693	815	1,016	681	
	Folding	33TC2060T18FD	873	956	1,078	1,279	958	
	Nesting	33TC2060T18NE	1,117	1,199	1,318	NA	1,233	
20 x 72	Static	33TC2072T18	649	748	886	1,120	719	
	Folding	33TC2072T18FD	912	1,012	1,150	1,383	996	
	Nesting	33TC2072T18NE	1,333	1,431	1,566	NA	1,481	
20 x 84	Static	33TC2084T18	794	924	1,067	1,292	913	
	Folding	33TC2084T18FD	989	1,119	1,262	1,487	1,118	
	Nesting	33TC2084T18NE	1,409	1,536	1,676	NA	1,601	
20 x 90	Static	33TC2090T18	840	988	1,131	1,342	913	
	Folding	33TC2090T18FD	1,035	1,184	1,326	1,537	1,118	
	Nesting	33TC2090T18NE	1,454	1,599	1,739	NA	1,601	
20 x 96	Static	33TC2096T18	840	988	1,145	1,392	934	
	Folding	33TC2096T18FD	1,035	1,184	1,340	1,587	1,139	
	Nesting	33TC2096T18NE	1,454	1,599	1,753	NA	1,622	

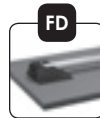
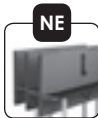

Element

- LC**  
+90
- CCG**  
+120
- OS**  
+35
- CH**  
NA
- WM**  
NA
- WMLC**  
NA
- SH**  
T+130
- FR**  
NA
- PB**  
NA
- GR**  
+40
- CM**  
+50
- RC**  
+55
- GN**  
+40
- LT**  
+115
- AH**  
NA
- NU**  
NA

Top Size	Base	Model Number	3P	3K	3W	W1-W4	F1-F5	Rectangular with T-bases
24 x 36	Static	33TC2436T22	\$ 542	\$ 599	\$ 695	\$ 854	\$ 637	    <p>Folding T      Nesting T</p>
	Nesting	33TC2436T22NE	968	1,023	1,117	NA	1,102	
24 x 48	Static	33TC2448T22	588	663	773	962	655	
	Folding	33TC2448T22FD	841	916	1,026	1,215	921	
24 x 60	Nesting	33TC2448T22NE	1,040	1,113	1,221	NA	1,148	
	Static	33TC2460T22	609	693	824	1,074	719	
	Folding	33TC2460T22FD	873	956	1,088	1,337	996	
24 x 72	Nesting	33TC2460T22NE	1,117	1,199	1,327	NA	1,270	
	Static	33TC2472T22	649	748	896	1,181	752	
	Folding	33TC2472T22FD	912	1,012	1,159	1,445	1,029	
24 x 84	Nesting	33TC2472T22NE	1,333	1,431	1,575	NA	1,514	
	Static	33TC2484T22	794	924	1,076	1,361	988	
	Folding	33TC2484T22FD	989	1,119	1,271	1,557	1,193	
24 x 90	Nesting	33TC2484T22NE	1,409	1,536	1,685	NA	1,675	
	Static	33TC2490T22	840	988	1,140	1,415	999	
	Folding	33TC2490T22FD	1,035	1,184	1,336	1,610	1,204	
24 x 96	Nesting	33TC2490T22NE	1,454	1,599	1,748	NA	1,685	
	Static	33TC2496T22	840	988	1,154	1,469	1,009	
	Folding	33TC2496T22FD	1,035	1,184	1,349	1,664	1,214	
30 x 36	Nesting	33TC2496T22NE	1,454	1,599	1,762	NA	1,696	
	Static	33TC3036T26	579	649	749	919	684	
	Nesting	33TC3036T26NE	1,004	1,073	1,170	NA	1,148	
30 x 48	Static	33TC3048T26	636	729	839	1,042	695	
	Folding	33TC3048T26FD	889	982	1,092	1,295	961	
	Nesting	33TC3048T26NE	1,087	1,178	1,286	NA	1,187	
30 x 60	Static	33TC3060T26	654	754	886	1,161	855	
	Folding	33TC3060T26FD	917	1,017	1,150	1,425	1,131	
	Nesting	33TC3060T26NE	1,160	1,258	1,388	NA	1,403	
30 x 72	Static	33TC3072T26	698	816	963	1,281	930	
	Folding	33TC3072T26FD	961	1,079	1,226	1,544	1,207	
	Nesting	33TC3072T26NE	1,381	1,497	1,641	NA	1,688	
30 x 84	Static	33TC3084T26	874	1,036	1,178	1,468	1,012	
	Folding	33TC3084T26FD	1,070	1,231	1,373	1,663	1,217	
	Nesting	33TC3084T26NE	1,488	1,646	1,785	NA	1,699	
30 x 90	Static	33TC3090T26	932	1,116	1,255	1,530	1,033	
	Folding	33TC3090T26FD	1,127	1,311	1,450	1,725	1,238	
	Nest/Lightwt	33TC3090T26NE-LT	1,657	NA	1,985	NA	NA	
30 x 96	Static	33TC3096T26	932	1,116	1,268	1,587	1,044	
	Folding	33TC3096T26FD	1,127	1,311	1,464	1,783	1,249	
	Nest/Lightwt	33TC3096T26NE-LT	1,657	NA	1,999	NA	NA	



- LC**  
+90
- CCG**  
+120
- OS**  
+35
- CH**  
NA
- WM**  
NA
- WMLC**  
NA
- SH**  
T+130
- FR**  
NA
- PB**  
NA
- GR**  
+40
- CM**  
+50
- RC**  
+55
- GN**  
+40
- LT**  
+115
- AH**  
NA
- NU**  
NA

Rectangular with T-bases	Top Size	Base	Model Number	3P	3K	3W	W1-W4	F1-F5
    Folding T    Nesting T	36 x 48	Static	33TC3648T26	\$ 681	\$ 792	\$ 902	\$ 1,115	\$ 745
		Folding	33TC3648T26FD	934	1,045	1,156	1,368	1,010
		Nesting	33TC3648T26NE	1,290	1,399	1,507	NA	1,428
	36 x 60	Static	33TC3660T26	749	887	1,005	1,246	951
		Folding	33TC3660T26FD	1,012	1,150	1,268	1,509	1,228
		Nesting	33TC3660T26NE	1,411	1,547	1,663	NA	1,688
	36 x 72	Static	33TC3672T26	791	947	1,080	1,377	1,072
		Folding	33TC3672T26FD	1,055	1,210	1,343	1,640	1,349
		Nesting	33TC3672T26NE	1,473	1,625	1,756	NA	1,828
36 x 84	Static	33TC3684T26	952	1,145	1,278	1,576	1,165	
	Folding	33TC3684T26FD	1,148	1,340	1,473	1,771	1,370	
	Nest/Lightwt	33TC3684T26NE-LT	1,677	NA	2,008	NA	NA	
36 x 90	Static	33TC3690T26	1,019	1,239	1,365	1,641	1,175	
	Folding	33TC3690T26FD	1,215	1,434	1,560	1,836	1,380	
	Nest/Lightwt	33TC3690T26NE-LT	1,743	NA	2,093	NA	NA	
36 x 96	Static	33TC3696T26	1,019	1,239	1,379	1,707	1,181	
	Folding	33TC3696T26FD	1,215	1,434	1,574	1,902	1,386	
	Nest/Lightwt	33TC3696T26NE-LT	1,743	NA	2,107	NA	NA	



Rectangular with TT-bases	Top Size	Base	Model Number	3P	3K	3W	W1-W4	F1-F5
 	42 x 60	Static	33TC4260TT30	\$ 1,047	\$ 1,209	\$ 1,323	\$ 1,566	\$ 1,192
	42 x 72	Static	33TC4272TT30	1,128	1,322	1,439	1,708	1,323
	42 x 84	Static	33TC4284TT30	1,273	1,498	1,620	1,919	1,416
	42 x 90	Static	33TC4290TT30	1,348	1,604	1,717	1,988	1,437
	42 x 96	Static	33TC4296TT30	1,348	1,604	1,731	2,061	1,448
	48 x 60	Static	33TC4860TT36	1,142	1,327	1,438	1,688	1,343
	48 x 72	Static	33TC4872TT36	1,235	1,456	1,567	1,842	1,474
	48 x 84	Static	33TC4884TT36	1,311	1,536	1,672	2,060	1,567
	48 x 90	Static	33TC4890TT36	1,387	1,643	1,770	2,137	1,609
	48 x 96	Static	33TC4896TT36	1,387	1,643	1,783	2,214	1,620



Element

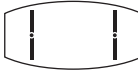

<b>LC</b> +90	<b>CCG</b> +120	<b>OS</b> +35	<b>CH</b> NA	<b>WM</b> NA	<b>WMLC</b> NA	<b>SH</b> T+130 TT+260	<b>FR</b> NA	<b>PB</b> NA	<b>GR</b> +40	<b>CM</b> +50	<b>RC</b> +55	<b>GN</b> +40	<b>LT</b> +115	<b>AH</b> NA	<b>NU</b> NA
------------------	--------------------	------------------	-----------------	-----------------	-------------------	------------------------------	-----------------	-----------------	------------------	------------------	------------------	------------------	-------------------	-----------------	-----------------

Top Size	Base	Model Number	3P	3K	3W	W1-W4	F1-F5	Rectangular with 3 TT-bases
42 x 120	Static	33TC42120TT30(3)	\$ 1,950	\$ 2,329	\$ 2,419	\$ 2,634	\$ 2,419	 
42 x 144	Static	33TC42144TT30(3)	2,105	2,546	2,645	2,915	2,440	
48 x 120	Static	33TC48120TT36(3)	2,016	2,399	2,500	2,829	2,531	
48 x 144	Static	33TC48144TT36(3)	2,089	2,518	2,623	3,009	2,485	

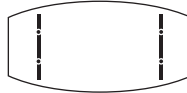
3 bases: **LC** **SH**  
+135 quote

Top Size	Base	Model Number	3P	3K	3W	W1-W4	F1-F5	Boat-Shaped with T-bases
30 x 42 x 84	Static	33BT3084T26	\$ 1,235	\$ 1,541	\$ 1,561	\$ 2,280	\$ 1,299	 
30 x 42 x 90	Static	33BT3090T26	1,343	1,692	1,694	2,380	1,325	
30 x 42 x 96	Static	33BT3096T26	1,343	1,692	1,707	2,476	1,337	

Top Size	Base	Model Number	3P	3K	3W	W1-W4	F1-F5	Boat-Shaped with TT-bases
36 x 48 x 84	Static	33BT3684TT36	\$ 1,619	\$ 1,968	\$ 1,963	\$ 2,699	\$ 1,603	 
36 x 48 x 90	Static	33BT3690TT36	1,742	2,140	2,113	2,803	1,655	
36 x 48 x 96	Static	33BT3696TT36	1,742	2,140	2,127	2,903	1,668	

Top Size	Base	Model Number	3P	3K	3W	W1-W4	F1-F5	Boat-Shaped with 3 TT-bases
36 x 48 x 120	Static	33BT36120TT36(3)	\$ 2,454	\$ 3,011	\$ 2,933	\$ 3,622	\$ 2,531	 
36 x 48 x 144	Static	33BT36144TT36(3)	2,700	3,356	3,260	4,034	2,584	

3 bases: **LC** **SH**  
+135 quote

- LC**  
+90
- CCG**  
+120
- OS**  
NA
- CH**  
NA
- WM**  
NA
- WMLC**  
NA
- SH**  
T+130  
TT+260
- FR**  
NA
- PB**  
NA
- GR**  
+40
- CM**  
+50
- RC**  
+55
- GN**  
+40
- LT**  
NA
- AH**  
NA
- NU**  
NA

Racetrack with T-bases	Top Size	Base	Model Number	3P	3K	3W	W1-W4	F1-F5
<div style="display: flex; justify-content: space-around; margin-top: 10px;"> <div style="border: 1px solid black; padding: 2px; font-weight: bold;">FD</div> <div style="border: 1px solid black; padding: 2px; font-weight: bold;">NE</div> </div> <div style="display: flex; justify-content: space-around; margin-top: 5px;"> <span>Folding T</span> <span>Nesting T</span> </div>	36 x 60	Static	33RT3660T26	\$ 876	\$ 1,066	\$ 1,110	\$ 1,708	\$ 1,057
		Nesting	33RT3660T26NE	1,482	1,668	1,711	NA	1,735
	36 x 72	Static	33RT3672T26	967	1,193	1,237	1,889	1,202
		Folding	33RT3672T26FD	1,230	1,456	1,501	2,152	1,479
		Nesting	33RT3672T26NE	1,626	1,847	1,890	NA	1,935
	36 x 84	Static	33RT3684T26	1,130	1,393	1,437	2,141	1,299
		Folding	33RT3684T26FD	1,325	1,589	1,632	2,337	1,504
	36 x 90	Static	33RT3690T26	1,252	1,564	1,585	2,234	1,312
		Folding	33RT3690T26FD	1,447	1,759	1,781	2,429	1,517
	36 x 96	Static	33RT3696T26	1,252	1,564	1,599	2,322	1,318
		Folding	33RT3696T26FD	1,447	1,759	1,794	2,518	1,523

Racetrack with TT-bases	Top Size	Base	Model Number	3P	3K	3W	W1-W4	F1-F5
	42 x 84	Static	33RT4284TT30	\$ 1,472	\$ 1,776	\$ 1,797	\$ 2,519	\$ 1,551
	42 x 90	Static	33RT4290TT30	1,583	1,931	1,933	2,619	1,576
	42 x 96	Static	33RT4296TT30	1,583	1,931	1,947	2,715	1,589
	48 x 84	Static	33RT4884TT36	1,742	2,140	2,099	2,699	1,603
	48 x 90	Static	33RT4890TT36	1,742	2,140	2,113	2,803	1,654
	48 x 96	Static	33RT4896TT36	1,742	2,140	2,127	2,903	1,666

Racetrack with 3 TT-bases	Top Size	Base	Model Number	3P	3K	3W	W1-W4	F1-F5
<div style="border: 1px solid black; padding: 5px; margin-top: 10px; display: flex; align-items: center;"> <span>3 bases:</span> <div style="margin: 0 5px;"> <div style="border: 1px solid black; padding: 2px; font-weight: bold;">LC</div> <div style="border: 1px solid black; padding: 2px; font-weight: bold;">SH</div> </div> <span>+135 quote</span> </div>	42 x 120	Static	33RT42120TT30(3)	\$ 2,384	\$ 2,936	\$ 2,854	\$ 3,393	\$ 2,419
	42 x 144	Static	33RT42144TT30(3)	2,628	3,278	3,178	3,781	2,440
	48 x 120	Static	33RT48120TT36(3)	2,454	3,012	2,934	3,622	2,531
	48 x 144	Static	33RT48144TT36(3)	2,701	3,357	3,261	4,034	2,584

Element

- LC

 +90
- CCG

 +120
- OS

 NA
- CH

 NA
- WM

 NA
- WMLC

 NA
- SH

 T+130  
TT+260
- FR

 NA
- PB

 NA
- GR

 +40
- CM

 +50
- RC

 NA
- GN

 NA
- LT

 NA
- AH

 NA
- NU

 NA



Top Size	Base	Model Number	3P	3K	3W	W1-W4	F1-F5	Elliptical with T-bases
30 x 54	Static	33EL3054T26	\$ 759	\$ 902	\$ 947	\$1,504	\$ 831	
30 x 60	Static	33EL3060T26	797	954	999	1,588	855	
36 x 60	Static	33EL3660T26	876	1,066	1,098	1,708	951	
36 x 72	Static	33EL3672T26	967	1,193	1,219	1,889	1,072	
36 x 84	Static	33EL3684T26	1,130	1,393	1,413	2,141	1,165	
36 x 90	Static	33EL3690T26	1,252	1,564	1,558	2,234	1,211	
36 x 96	Static	33EL3696T26	1,252	1,564	1,569	2,322	1,236	

Top Size	Base	Model Number	3P	3K	3W	W1-W4	F1-F5	Elliptical with TT-bases
42 x 72	Static	33EL4272TT30	\$1,301	\$1,564	\$1,574	\$2,259	\$1,323	
42 x 84	Static	33EL4284TT30	1,472	1,776	1,776	2,519	1,416	
42 x 90	Static	33EL4290TT30	1,585	1,934	1,911	2,619	1,437	
42 x 96	Static	33EL4296TT30	1,585	1,934	1,922	2,715	1,448	
48 x 72	Static	33EL4872TT36	1,529	1,841	1,788	2,495	1,546	
48 x 84	Static	33EL4884TT36	1,541	1,858	1,859	2,699	1,567	
48 x 90	Static	33EL4890TT36	1,743	2,141	2,093	2,803	1,609	
48 x 96	Static	33EL4896TT36	1,743	2,141	2,104	2,903	1,620	

Top Size	Base	Model Number	3P	3K	3W	W1-W4	F1-F5	Elliptical with 3 TT-bases
42 x 120	Static	33EL42120TT30(3)	\$2,384	\$2,936	\$2,816	\$3,393	\$2,419	
42 x 144	Static	33EL42144TT30(3)	2,628	3,278	3,128	3,781	2,440	
48 x 120	Static	33EL48120TT36(3)	2,454	3,012	2,898	3,622	2,531	
48 x 144	Static	33EL48144TT36(3)	2,701	3,357	3,213	4,034	2,584	



3 bases: **LC** **SH**  
+135 quote

- LC**  
+90
- CCG**  
+120
- OS**  
NA
- CH**  
NA
- WM**  
NA
- WMLC**  
NA
- SH**  
T+130  
TT+260
- FR**  
NA
- PB**  
NA
- GR**  
+40
- CM**  
+50
- RC**  
NA
- GN**  
NA
- LT**  
NA
- AH**  
NA
- NU**  
NA



Square with X-base	Top Size	Base	Model Number	3P	3K	3W	W1-W4	F1-F5
 	24 x 24	Static	33SQ2424X22	\$ 537	\$ 575	\$ 657	\$ 787	\$ 589
		Flip Top	33SQ2424X22FT	663	701	783	913	722
	30 x 30	Static	33SQ3030X26	600	659	753	910	658
		Flip Top	33SQ3030X26FT	726	785	879	1,036	790
	36 x 36	Static	33SQ3636X32	674	758	861	1,045	819
		Flip Top	33SQ3636X32FT	800	884	987	1,171	951
42 x 42	Static	33SQ4242X36	772	885	994	1,204	866	
	Flip Top	33SQ4242X36FT	897	1,011	1,120	1,330	998	



Flip Top X

Square with 4-column X-base	Top Size	Base	Model Number	3P	3K	3W	W1-W4	F1-F5
 	48 x 48	Static	33SQ4848X36.4	\$ 1,392	\$ 1,539	\$ 1,651	\$ 1,883	\$ 1,450
	54 x 54	Static	33SQ5454X36.4	1,488	1,673	1,783	2,037	NA
	60 x 60	Static	33SQ6060X42.4	1,623	1,851	1,957	2,232	NA

X.4 bases: **SH**  
+260



Square with TT-bases	Top Size	Base	Model Number	3P	3K	3W	W1-W4	F1-F5
 	48 x 48	Static	33SQ4848TT26	\$ 1,010	\$ 1,157	\$ 1,268	\$ 1,501	\$ 1,049

Element

online updates  
new product  
clarification / edit  
deletion

- LC**  
+90
- CCG**  
NA
- OS**  
NA
- CH**  
NA
- WM**  
NA
- WMLC**  
X+45  
TT:NA
- SH**  
X+65  
TT+260
- FR**  
+150
- PB**  
NA
- GR**  
+40
- CM**  
+50
- RC**  
+55
- GN**  
+40
- LT**  
+115
- AH**  
NA
- NU**  
NA



Top Size	Base	Model Number	3P	3K	3W	W1-W4	F1-F5	Round with X-base
24 x 24	Static	33RD24X22	\$ 568	\$ 620	\$ 668	\$ 995	\$ 589	 
	Flip Top	33RD24X22FT	694	745	794	1,121	722	
30 x 30	Static	33RD30X26	650	729	779	1,188	658	
	Flip Top	33RD30X26FT	776	855	904	1,313	790	
36 x 36	Static	33RD36X32	735	844	893	1,399	819	
	Flip Top	33RD36X32FT	861	970	1,019	1,525	951	
42 x 42	Static	33RD42X32	833	981	1,022	1,619	841	
	Flip Top	33RD42X32FT	959	1,106	1,148	1,745	973	
48 x 48	Static	33RD48X36	885	1,043	1,098	1,882	887	

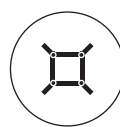

online updates  
new product  
clarification / edit  
deletion

Top Size	Base	Model Number	3P	3K	3W	W1-W4	F1-F5	Round with 4-column X-base
54 x 54	Static	33RD54X36.4	\$ 1,581	\$ 1,803	\$ 1,832	\$ 2,680	NA	 
60 x 60	Static	33RD60X36.4	1,603	1,834	1,878	2,957	NA	

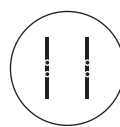

X.4 bases: **SH**  
+260

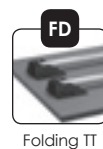
Top Size	Base	Model Number	3P	3K	3W	W1-W4	F1-F5	Round with TT-base
48 x 48	Static	33RD48TT26	\$ 1,039	\$ 1,197	\$ 1,252	\$ 2,035	\$ 1,049	 
54 x 54	Static	33RD54TT30	1,198	1,420	1,449	2,297	NA	
60 x 60	Static	33RD60TT30	1,220	1,451	1,496	2,574	NA	
	Folding	33RD60TT30FD	1,803	2,034	2,078	NA	NA	



- LC**  
+90
- CCG**  
NA
- OS**  
NA
- CH**  
NA
- WM**  
NA
- WMLC**  
X+45  
TT:NA
- SH**  
X+65  
TT+260
- FR**  
+150
- PB**  
NA
- GR**  
+40
- CM**  
+50
- RC**  
NA
- GN**  
NA
- LT**  
NA
- AH**  
NA
- NU**  
NA

Element

D-shaped with T-bases	Top Size	Base	Model Number	3P	3K	3W	W1-W4	F1-F5
	24 x 36	Static	33D2436T20	\$ 588	\$ 663	\$ 733	\$ 1,024	\$ 636
		Nesting	33D2436T20NE	1,012	1,086	1,155	NA	1,101
	24 x 48	Static	33D2448T20	650	750	830	1,158	709
		Nesting	33D2448T20NE	1,074	1,172	1,249	NA	1,173
	24 x 60	Static	33D2460T20	713	838	926	1,293	782
		Nesting	33D2460T20NE	1,162	1,285	1,371	NA	1,273
	24 x 72	Static	33D2472T20	775	925	1,023	1,428	855
		Nesting	33D2472T20NE	1,317	1,464	1,560	NA	1,468
 Nesting T	24 x 84	Static	33D2484T20	906	1,081	1,187	1,631	1,000
		Nesting	33D2484T20NE	1,519	1,690	1,794	NA	1,686
	24 x 90	Static	33D2490T20	937	1,125	1,235	1,700	1,036
		Nesting	33D2490T20NE	1,549	1,733	1,842	NA	1,722
	24 x 96	Static	33D2496T20	968	1,168	1,284	1,769	1,072
		Nesting	33D2496T20NE	1,580	1,776	1,889	NA	1,758
	30 x 48	Static	33D3048T26	716	841	912	1,257	785
		Nesting	33D3048T26NE	1,138	1,260	1,330	NA	1,247
	30 x 60	Static	33D3060T26	794	950	1,026	1,404	855
		Nesting	33D3060T26NE	1,242	1,395	1,469	NA	1,344
	30 x 72	Static	33D3072T26	872	1,059	1,139	1,550	967
		Nesting	33D3072T26NE	1,412	1,596	1,674	NA	1,578
	30 x 84	Static	33D3084T26	1,018	1,237	1,321	1,764	1,130
		Nesting	33D3084T26NE	1,629	1,843	1,926	NA	1,814
	30 x 90	Static	33D3090T26	1,057	1,292	1,378	1,837	1,176
		Nest/Lightwt	33D3090T26NE-LT	1,742	NA	NA	NA	NA
	30 x 96	Static	33D3096T26	1,096	1,346	1,435	1,910	1,221
		Nest/Lightwt	33D3096T26NE-LT	1,818	NA	NA	NA	NA
	36 x 48	Static	33D3648T26	778	928	992	1,354	858
		Nesting	33D3648T26NE	1,199	1,346	1,408	NA	1,318
	36 x 60	Static	33D3660T26	872	1,059	1,123	1,511	967
		Nesting	33D3660T26NE	1,440	1,624	1,686	NA	1,582
	36 x 72	Static	33D3672T26	966	1,191	1,253	1,665	1,072
		Nesting	33D3672T26NE	1,624	1,845	1,906	NA	1,807
	36 x 84	Static	33D3684T26	1,127	1,390	1,452	1,891	1,165
		Nest/Lightwt	33D3684T26NE-LT	1,849	NA	NA	NA	NA
	36 x 90	Static	33D3690T26	1,174	1,456	1,518	1,972	1,319
		Nest/Lightwt	33D3690T26NE-LT	1,895	NA	NA	NA	NA
	36 x 96	Static	33D3696T26	1,221	1,521	1,583	2,049	1,329
		Nest/Lightwt	33D3696T26NE-LT	1,941	NA	NA	NA	NA

new

Element



- LC**  
+90
- CCG**  
+120
- OS**  
+35
- CH**  
NA
- WM**  
NA
- WMLC**  
NA
- SH**  
T+130
- FR**  
NA
- PB**  
NA
- GR**  
+40
- CM**  
+50
- RC**  
+55
- GN**  
+40
- LT**  
NA
- AH**  
NA
- NU**  
NA



Top Size	Base	Model Number	3P	3K	3W	W1-W4	F1-F5	D-shaped with TT-bases
42 x 60	Static	33D4260TT30	\$ 1,189	\$ 1,408	\$ 1,459	\$ 1,855	\$ 1,310	
42 x 72	Static	33D4272TT30	1,299	1,561	1,607	2,024	1,323	
42 x 84	Static	33D4284TT30	1,577	1,923	1,933	2,257	1,416	
42 x 90	Static	33D4290TT30	1,639	2,010	2,015	2,342	1,437	
42 x 96	Static	33D4296TT30	1,701	2,096	2,097	2,427	1,580	
48 x 60	Static	33D4860TT36	1,305	1,555	1,593	2,000	1,441	
48 x 72	Static	33D4872TT36	1,430	1,730	1,758	2,177	1,474	
48 x 84	Static	33D4884TT36	1,623	1,973	1,992	2,426	1,567	
48 x 90	Static	33D4890TT36	1,686	2,061	2,074	2,603	1,609	
48 x 96	Static	33D4896TT36	1,748	2,148	2,157	2,603	1,620	



Top Size	Base	Model Number	3P	3K	3W	W1-W4	F1-F5	D-shaped with 4-column X-base
54 x 54	Static	33D5454X36.4	\$ 1,798	\$ 2,108	\$ 2,112	\$ 2,360	\$ NA	
60 x 60	Static	33D6060X42.4	1,836	2,148	2,161	2,590	NA	

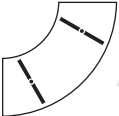

X.4 bases: **SH**  
+260

- LC**  
+90
- CCG**  
+120
- OS**  
NA
- CH**  
NA
- WM**  
NA
- WMLC**  
X+45  
TT:NA
- SH**  
TT+260
- FR**  
NA
- PB**  
NA
- GR**  
+40
- CM**  
+50
- RC**  
+55
- GN**  
+40
- LT**  
NA
- AH**  
NA
- NU**  
NA

Half Round with T-bases	Top Size	Base	Model Number	3P	3K	3W	W1-W4	F1-F5
   Nesting T	18 x 36	Static	33HR1836T16	\$ 596	\$ 675	\$ 723	\$ 1,174	\$ 582
	24 x 48	Static	33HR2448T16	653	754	821	1,474	709
		Nesting	33HR2448T16NE	1,076	1,176	1,241	NA	1,173
	30 x 60	Static	33HR3060T22	792	949	1,010	1,793	873
		Nesting	33HR3060T22NE	1,213	1,367	1,426	NA	1,333
	36 x 72	Static	33HR3672T26	964	1,189	1,234	2,142	1,077
Nesting		33HR3672T26NE	1,568	1,788	1,833	NA	1,689	

Crescent with T-bases	Top Size	Base	Model Number	3P	3K	3W	W1-W4	F1-F5
 	24 x 48 x 75	Static	33CS2475T22	\$ 1,195	\$ 1,513	\$ 1,461	\$ 1,797	\$ 1,560
	24 x 60 x 94	Static	33CS2494T22	1,518	1,965	1,865	2,074	1,560
	30 x 60 x 94	Static	33CS3094T26	1,521	1,968	1,865	2,235	1,563

Trapezoid with T-bases	Top Size	Base	Model Number	3P	3K	3W	W1-W4	F1-F5
   Nesting T	24 x 48	Static	33TZ2448T18	\$ 645	\$ 743	\$ 808	\$ 1,255	\$ 709
	24 x 72	Static	33TZ2472T18	804	965	1,038	1,593	855
		Nesting	33TZ2472T18NE	1,251	1,409	1,481	NA	1,344
	30 x 60	Static	33TZ3060T22	751	891	959	1,562	873
		Nesting	33TZ3060T22NE	1,172	1,310	1,376	NA	1,333
	36 x 72	Static	33TZ3672T26	942	1,158	1,204	1,908	1,077
Nesting		33TZ3672T26NE	1,519	1,731	1,776	NA	1,725	

Corner with TT-bases	Top Size	Base	Model Number	3P	3K	3W	W1-W4	F1-F5
 	24 x 42	Static	33CR2442TT30	\$ 1,063	\$ 1,231	\$ 1,290	\$ 1,947	\$ 927
	30 x 48	Static	33CR3048TT30	1,095	1,277	1,353	2,220	1,036

Element

new

- LC  
+90
- CCG  
+120
- OS  
+35
- CH  
NA
- WM  
NA
- WMLC  
NA
- SH  
T+130  
TT+260
- FR  
NA
- PB  
NA
- GR  
+40
- CM  
+50
- RC  
+55
- GN  
+40
- LT  
NA
- AH  
NA
- NU  
NA

Top Size	Base	Model Number	3P	3K	3W	W1-W4	F1-F5	Arc Segment with T-bases
20 x 44	Static	33AS2044T18	\$ 678	\$ 789	\$ 821	NA	\$ 640	
24 x 51	Static	33AS2451T18	747	886	914	NA	734	
30 x 59	Static	33AS3059T26	820	986	1,018	NA	876	
36 x 67	Static	33AS3667T26	986	1,219	1,242	NA	1,077	

Top Size	Base	Model Number	3P	3K	3W	W1-W4	F1-F5	Ganging Quarter Round (with T-base)
20 x 20	Ganging	QR2020GN	\$ 224	\$ 272	\$ 319	NA	\$ 236	
24 x 24	Ganging	QR2424GN	233	284	344	NA	236	
30 x 30	Static, GN	33QR3030GNT22	472	551	616	NA	472	
	Ganging	QR3030GN	301	380	444	NA	292	
36 x 36	Static, GN	33QR3636GNT22	536	641	711	NA	622	
	Ganging	QR3636GN	365	469	540	NA	442	

1 base: **LC** **CCG** **OS** **SH**  
NA NA +18 +65

**GN**  
Ganging included

Top Size	Base	Model Number	3P	3K	3W	W1-W4	F1-F5	Ganging 45° Wedge (with T-base)
20 x 20	Ganging	WG45D20GN	\$ 224	\$ 272	\$ 315	NA	\$ 236	
24 x 24	Ganging	WG45D24GN	233	284	337	NA	236	
30 x 30	Ganging	WG45D30GN	301	380	432	NA	292	
36 x 36	Static, GN	33WG45D36GNT18	536	641	692	NA	622	
	Ganging	WG45D36GN	365	469	520	NA	442	

1 base: **LC** **CCG** **OS** **SH**  
NA NA +18 +65



**GN**  
Ganging included



Top Size	Base	Model Number	3P	3K	3W	W1-W4	F1-F5	Ganging 60° Wedge (with T-base)
20 x 20	Ganging	WG60D20GN	\$ 246	\$ 302	\$ 343	NA	\$ 236	
24 x 24	Ganging	WG60D24GN	254	314	366	NA	236	
30 x 30	Static, GN	33WG60D30GNT18	494	581	633	NA	472	
	Ganging	WG60D30GN	322	410	462	NA	292	
36 x 36	Static, GN	33WG60D36GNT18	558	671	725	NA	622	
	Ganging	WG30D36GN	386	499	553	NA	442	



1 base: **LC** **CCG** **OS** **SH**  
NA NA +18 +65

**GN**  
Ganging included



- LC**  
+90
- CCG**  
+120
- OS**  
+35
- CH**  
NA
- WM**  
NA
- WMLC**  
NA
- SH**  
T+130
- FR**  
NA
- PB**  
NA
- GR**  
+40
- CM**  
+50
- RC**  
+55
- GN**  
+40
- LT**  
NA
- AH**  
NA
- NU**  
NA

Video Wedge with T-bases	Top Size	Base	Model Number	3P	3K	3W	W1-W4	F1-F5
 	20 x 20 x 40	Static	33VW2040T18	\$ 635	\$ 729	\$ 789	NA	\$ 620
	24 x 24 x 48	Static	33VW2448T18	678	789	862	NA	709
	30 x 30 x 60	Static	33VW3060T26	820	986	1,056	NA	876
	36 x 36 x 72	Static	33VW3672T26	1,070	1,336	1,370	NA	1,077

10° Transition with T-bases	Top Size	Base	Model Number	3P	3K	3W	W1-W4	F1-F5
 	20 x 30	Static	33TN2030T18	\$ 539	\$ 595	\$ 660	NA	\$ 569
	24 x 30	Static	33TN2430T18	550	610	680	NA	600
	30 x 30	Static	33TN3030T26	608	690	756	NA	648
	36 x 30	Static	33TN3630T26	672	780	838	NA	694

Trident with 3 Offset T-bases	Top Size	Base	Model Number	3P	3K	3W	W1-W4	F1-F5
 	36 x 36 x 18	Static	33TR3618TOS16(3)	\$ 1,107	\$ 1,299	\$ 1,283	\$ 1,639	\$ 996
	40 x 40 x 20	Static	33TR4020TOS16(3)	1,213	1,447	1,413	1,762	1,260
	48 x 48 x 24	Static	33TR4824TOS16(3)	1,226	1,465	1,456	2,035	1,260
	60 x 60 x 30	Static	33TR6030TOS16(3)	1,413	1,728	1,704	2,470	NA

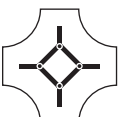
3 bases: **LC** **SH**  
+135 +195

Quadrant with 4-Column X-base	Top Size	Base	Model Number	3P	3K	3W	W1-W4	F1-F5
 	60 x 60 x 18	Static	33QD6018X36.4	\$ 1,855	\$ 2,186	\$ 2,173	\$ 3,026	NA
	60 x 60 x 20	Static	33QD6020X36.4	1,855	2,186	2,175	3,026	NA
	60 x 60 x 24	Static	33QD6024X36.4	1,855	2,186	2,179	3,026	NA
	60 x 60 x 30	Static	33QD6030X36.4	1,855	2,186	2,185	3,026	NA

X.4 bases: **SH**  
+260

Element

- LC**  
+90
- CCG**  
+120
- OS**  
+35
- CH**  
NA
- WM**  
NA
- WMLC**  
X+45  
T:NA
- SH**  
T+130
- FR**  
NA
- PB**  
NA
- GR**  
+40
- CM**  
+50
- RC**  
+55
- GN**  
+40
- LT**  
NA
- AH**  
NA
- NU**  
NA

Top Size	Base	Model Number	3P	3K	3W	W1-W4	F1-F5	Bulb with X-base
24 x 24 x 18	Static	33BU2418X22	\$ 768	\$ 899	\$ 893	\$ 1,361	\$ 606	
30 x 30 x 20	Static	33BU3020X26	819	965	970	1,630	700	
36 x 36 x 24	Static	33BU3624X32	936	1,125	1,120	1,907	813	
42 x 42 x 30	Static	33BU4230X32	1,033	1,261	1,250	2,192	931	
48 x 48 x 36	Static	33BU4836X36	1,070	1,303	1,311	2,505	1,094	

Top Size	Base	Model Number	3P	3K	3W	W1-W4	F1-F5	Squircle with X-base	NEW
24 x 24	Static	33SL24X22	\$ 722	\$ 834	\$ 861	\$ NA	\$ 589		
	Flip Top	33SL24X22FT	848	960	987	NA	722		
30 x 30	Static	33SL30X26	782	914	954	NA	658		
	Flip Top	33SL30X26FT	908	1,040	1,079	NA	790		
36 x 36	Static	33SL36X32	848	1,001	1,052	NA	819		
	Flip Top	33SL36X32FT	974	1,127	1,178	NA	951		
42 x 42	Static	33SL42X36	931	1,108	1,169	NA	866		
	Flip Top	33SL42X36FT	1,057	1,234	1,295	NA	998		

Top Size	Base	Model Number	3P	3K	3W	W1-W4	F1-F5	Table Desk with TT-bases
37 x 60	Static	33TA3760TT26	\$ 1,105	\$ 1,290	\$ 1,398	\$ 2,089	\$ 1,234	
42 x 78	Static	33TA4278TT30	1,428	1,715	1,805	2,581	1,637	

- LC  
+90
- CCG  
+120
- OS  
NA
- CH  
NA
- WM  
NA
- WMLC  
X+45  
TT:NA
- SH  
X+65  
TT+260
- FR  
NA
- PB  
NA
- GR  
+40
- CM  
+50
- RC  
+55
- GN  
+40
- LT  
NA
- AH  
NA
- NU  
NA



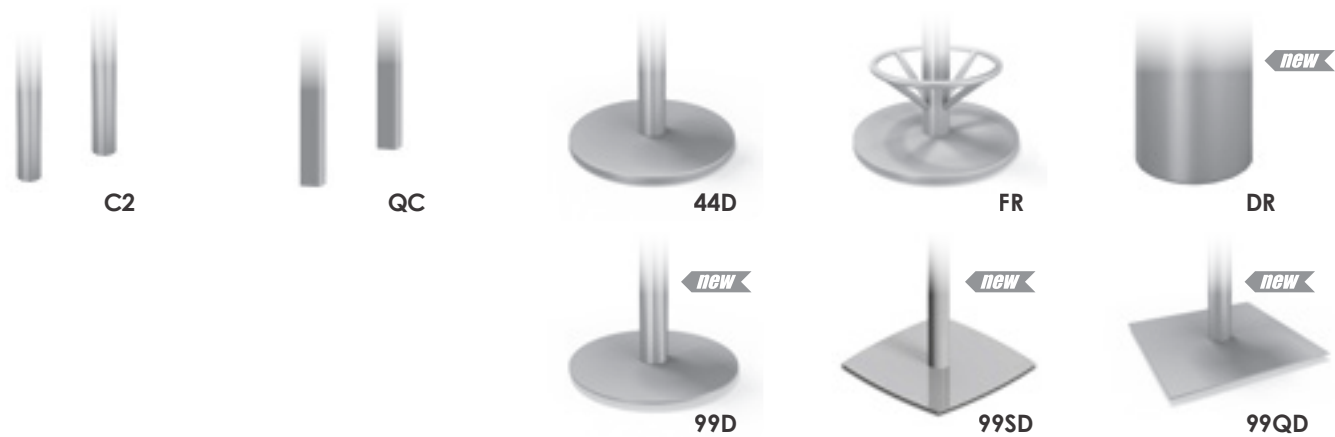

Maximize your foot space with durable traditional column bases. Primary's combination of columns, disc, and drum bases offer alternatives to meet a wide array of applications.

### Primary Base Styles



### Primary Base Options

 <p>standard glides</p>	<p><b>LC</b> <b>Locking Casters</b> can be added to any table for \$90.</p>	<p><b>CH</b> <b>Chrome Finish</b> available for \$25 per column. Upcharge for 44D disc bases is \$400.</p>	<p><b>SH</b> <b>Special Height</b> of can be added to any table: + \$65 per column for heights &gt; 29" + \$35 per column for heights &lt; 29" Special height tables larger than 36x72" must be custom quoted.</p>
	<p><b>QC</b> <b>Square Columns</b> are available for an upcharge of \$35 per column.</p>	<p><b>WM</b> <b>Wire Management</b> Built in wire management is available on one column for \$125.</p>	<p><b>FR</b> <b>Footring</b> available on standing height disc-bases for \$150 per base. Not available in chrome.</p>
 <p>locking casters</p>	<p><b>FD</b> <b>Folding Bases</b> are not available on Primary tables.</p>	<p><b>WMLC</b> <b>Wire Management Leg Covers</b> snap onto round columns and are \$45 each.</p>	<p><b>FR</b> <b>Footring</b> available on standing height disc-bases for \$150 per base. Not available in chrome.</p>
	<p><b>NE</b> <b>Nesting Tables</b> are not available on Primary tables.</p>	<p><b>MMLC</b> <b>Magnet Wire Management Leg Covers</b> Magnetically snap onto any square leg and are \$55 each.</p>	<p><b>PB</b> <b>Power Box Mounting Plate</b> is available on disc bases for \$90.</p>
	<p><b>FT</b> <b>Flip Tops</b> available some disc-based tables and are priced with standard glides.</p>		

Primary



## Primary Height Adjustable Options

- NU Pneumatic** is available on disc bases for \$350 per table.
- AH Spring Clip** is available on X-bases for \$125 and on round column bases for \$500 per table. Not available in chrome.
- RA Ratchet** is not available on Primary tables.
- BL Counterbalanced and short balanced** are available on disc bases and are available in three finishes:
  - 02 Black
  - 30 Pearl
  - 37 Satin Silver

## Primary Top Shapes

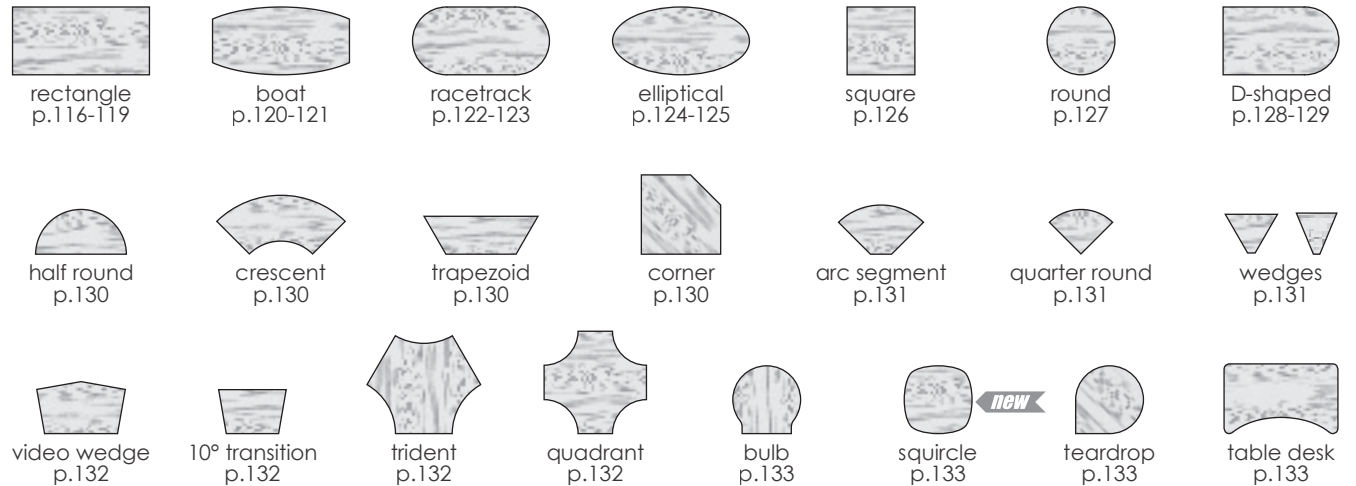

## Primary Top Options

- RC 3" Radius Corners** can be added to any table for \$55.
- LT Lightweight Tops** can be added to any square or rectangular table for \$115.
- GR Grommets** can be added to any table for \$40 each. To see specific locations, see page 203.
- CM Cable Manager** can be added to any table for \$50 each. To see specific locations, see page 203.
- GN Ganging Brackets** can be added to most table shapes for \$40.

## Primary Edge Options

(correspond with 5 columns of pricing)

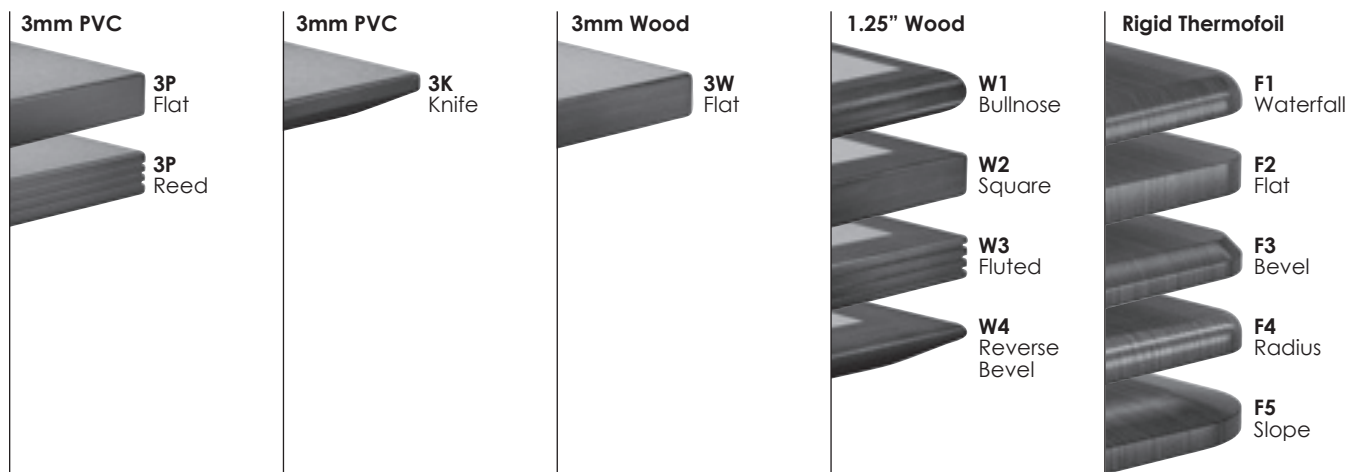

Rectangular with column bases	Top Size	Base	Model Number	3P	3K	3W	W1-W4	F1-F5
	18 x 36	Static	44TC1836C2	\$ 490	\$ 533	\$ 626	\$ 775	\$ 539
	18 x 48	Static	44TC1848C2	525	582	692	871	564
	18 x 60	Static	44TC1860C2	628	700	826	1,039	701
	18 x 72	Static	44TC1872C2	663	748	892	1,139	793
	18 x 84	Static	44TC1884C2	698	797	959	1,239	816
	18 x 90	Static	44TC1890C2	733	846	1,011	1,289	816
	18 x 96	Static	44TC1896C2	733	846	1,025	1,336	826
	20 x 36	Static	44TC2036C2	524	581	668	794	558
	20 x 48	Static	44TC2048C2	570	645	746	898	575
	20 x 60	Static	44TC2060C2	660	743	865	1,066	734
	20 x 72	Static	44TC2072C2	699	799	937	1,170	772
	20 x 84	Static	44TC2084C2	776	906	1,049	1,274	894
	20 x 90	Static	44TC2090C2	822	971	1,113	1,324	894
	20 x 96	Static	44TC2096C2	822	971	1,127	1,374	915
	24 x 36	Static	44TC2436C2	524	581	677	837	619
	24 x 48	Static	44TC2448C2	570	645	755	944	636
	24 x 60	Static	44TC2460C2	660	743	874	1,124	772
	24 x 72	Static	44TC2472C2	699	799	946	1,232	805
	24 x 84	Static	44TC2484C2	776	906	1,058	1,343	969
	24 x 90	Static	44TC2490C2	822	971	1,122	1,397	980
	24 x 96	Static	44TC2496C2	822	971	1,136	1,451	991
	30 x 36	Static	44TC3036C2	558	629	728	898	662
	30 x 48	Static	44TC3048C2	615	708	818	1,021	673
	30 x 60	Static	44TC3060C2	701	801	934	1,209	904
	30 x 72	Static	44TC3072C2	745	863	1,010	1,328	980
	30 x 84	Static	44TC3084C2	854	1,015	1,157	1,447	991
	30 x 90	Static	44TC3090C2	911	1,095	1,234	1,509	1,012
	30 x 96	Static	44TC3096C2	911	1,095	1,248	1,567	1,022
	36 x 48	Static	44TC3648C2	660	771	882	1,094	723
	36 x 60	Static	44TC3660C2	796	934	1,052	1,293	1,001
	36 x 72	Static	44TC3672C2	839	994	1,127	1,424	1,122
	36 x 84	Static	44TC3684C2	932	1,124	1,257	1,555	1,143
	36 x 90	Static	44TC3690C2	999	1,218	1,344	1,620	1,154
	36 x 96	Static	44TC3696C2	999	1,218	1,358	1,686	1,159

Primary

- LC +90
- QC +140
- CH +100
- WM +125
- WMLC +45
- MMLC +55
- SH +260
- FR NA
- PB NA
- GR +40
- CM +50
- RC +55
- GN +40
- LT +115
- AH +500
- NU NA

Top Size	Base	Model Number	3P	3K	3W	W1-W4	F1-F5	Rectangular with 2 thin disc bases	NEW
24 x 60	Static	99TC2460D20	\$ 1,103	\$ 1,186	\$ 1,317	\$ 1,567	\$ 1,237		
24 x 72	Static	99TC2472D20	1,142	1,242	1,389	1,675	1,270		
24 x 84	Static	99TC2484D20	1,219	1,349	1,501	1,786	1,434		
24 x 90	Static	99TC2490D20	1,333	1,482	1,633	1,908	1,517		
24 x 96	Static	99TC2496D20	1,333	1,482	1,647	1,962	1,527		
30 x 60	Static	99TC3060D20	1,144	1,244	1,377	1,652	1,370		
30 x 72	Static	99TC3072D20	1,188	1,306	1,453	1,771	1,445		
30 x 84	Static	99TC3084D20	1,297	1,458	1,600	1,890	1,456		
30 x 90	Static	99TC3090D20	1,422	1,606	1,745	2,020	1,548		
30 x 96	Static	99TC3096D20	1,422	1,606	1,759	2,078	1,559		
36 x 72	Static	99TC3672D24	1,341	1,496	1,629	1,926	1,649		
36 x 84	Static	99TC3684D24	1,434	1,626	1,759	2,057	1,670		
36 x 90	Static	99TC3690D24	1,569	1,788	1,915	2,191	1,752		
36 x 96	Static	99TC3696D24	1,569	1,788	1,928	2,256	1,758		
42 x 72	Static	99TC4272D32	1,633	1,827	1,945	2,213	1,854		
42 x 84	Static	99TC4284D32	1,710	1,935	2,057	2,356	1,875		
42 x 90	Static	99TC4290D32	1,853	2,109	2,222	2,493	1,968		
42 x 96	Static	99TC4296D32	1,853	2,109	2,236	2,566	1,978		



2 thin disc bases: **CH** **SH**  
NA +130

Top Size	Base	Model Number	3P	3K	3W	W1-W4	F1-F5	Rectangular with 2 disc bases	NEW
24 x 60	Static	44TC2460D20	\$ 1,336	\$ 1,419	\$ 1,551	\$ 1,800	\$ 1,482		
24 x 72	Static	44TC2472D20	1,376	1,475	1,622	1,908	1,515		
24 x 84	Static	44TC2484D20	1,452	1,583	1,734	2,020	1,679		
24 x 90	Static	44TC2490D20	1,566	1,715	1,867	2,142	1,762		
24 x 96	Static	44TC2496D20	1,566	1,715	1,881	2,195	1,772		
30 x 60	Static	44TC3060D20	1,377	1,477	1,610	1,885	1,614		
30 x 72	Static	44TC3072D20	1,422	1,540	1,687	2,004	1,690		
30 x 84	Static	44TC3084D20	1,530	1,691	1,834	2,123	1,701		
30 x 90	Static	44TC3090D20	1,655	1,839	1,978	2,253	1,793		
30 x 96	Static	44TC3096D20	1,655	1,839	1,992	2,311	1,804		
36 x 72	Static	44TC3672D24	1,595	1,750	1,883	2,180	1,916		
36 x 84	Static	44TC3684D24	1,688	1,880	2,013	2,311	1,937		
36 x 90	Static	44TC3690D24	1,823	2,042	2,168	2,444	2,019		
36 x 96	Static	44TC3696D24	1,823	2,042	2,182	2,510	2,024		
42 x 72	Static	44TC4272D32	1,946	2,140	2,258	2,527	2,182		
42 x 84	Static	44TC4284D32	2,023	2,248	2,370	2,669	2,204		
42 x 90	Static	44TC4290D32	2,167	2,422	2,535	2,806	2,296		
42 x 96	Static	44TC4296D32	2,167	2,422	2,549	2,879	2,307		

2 disc base: **CH** **SH**  
+800 +130

- LC**  
NA
- QC**  
NA
- CH**  
NA
- WM**  
+125
- WMLC**  
+45
- WMLC**  
NA
- SH**  
+130
- FR**  
+300
- PB**  
NA
- GR**  
+40
- CM**  
+50
- RC**  
+55
- GN**  
+40
- LT**  
+115
- AH**  
NA
- NU**  
NA

NEW

Rectangular with drum bases	Top Size	Base	Model Number	3P	3K	3W	W1-W4	F1-F5
 	30 x 60	Drum	44TC3060DR18	\$3,519	\$3,619	\$3,751	\$4,026	\$3,863
	30 x 72	Drum	44TC3072DR18	3,563	3,681	3,828	4,146	3,938
	30 x 84	Drum	44TC3084DR18	3,671	3,833	3,975	4,265	3,949
	30 x 90	Drum	44TC3090DR18	3,797	3,981	4,120	4,394	4,042
	30 x 96	Drum	44TC3096DR18	3,797	3,981	4,133	4,452	4,052
	36 x 60	Drum	44TC3660DR18	3,614	3,752	3,870	4,111	3,960
	36 x 72	Drum	44TC3672DR18	3,656	3,812	3,945	4,242	4,080
	36 x 84	Drum	44TC3684DR18	3,749	3,942	4,074	4,373	4,102
	36 x 90	Drum	44TC3690DR18	3,884	4,104	4,230	4,506	4,184
	36 x 96	Drum	44TC3696DR18	3,884	4,104	4,244	4,572	4,189
	42 x 72	Drum	44TC4272DR24	3,957	4,151	4,269	4,538	4,294
	42 x 84	Drum	44TC4284DR24	4,035	4,260	4,382	4,680	4,316
	42 x 90	Drum	44TC4290DR24	4,178	4,433	4,546	4,818	4,408
	42 x 96	Drum	44TC4296DR24	4,178	4,433	4,560	4,891	4,419
	48 x 72	Drum	44TC4872DR24	4,027	4,248	4,359	4,634	4,406
	48 x 84	Drum	44TC4884DR24	4,035	4,260	4,396	4,784	4,427
	48 x 90	Drum	44TC4890DR24	4,179	4,434	4,561	4,929	4,541
	48 x 96	Drum	44TC4896DR24	4,179	4,434	4,575	5,006	4,551

drum bases: **CH** **SH**  
NA NA

Primary

- LC**  
NA
- QC**  
NA
- CH**  
NA
- WM**  
NA
- WMLC**  
NA
- WMLC**  
NA
- SH**  
NA
- FR**  
NA
- PB**  
NA
- GR**  
+40
- CM**  
+50
- RC**  
+55
- GN**  
+40
- LT**  
+115
- AH**  
NA
- NU**  
NA

Top Size	Base	Model Number	3P	3K	3W	W1-W4	F1-F5	Rectangular with 3 thin disc bases	<i>NEW</i>
42 x 120	Static	99TC42120D32(3)	\$2,708	\$3,087	\$3,177	\$3,392	\$3,215		
42 x 144	Static	99TC42144D32(3)	2,863	3,304	3,403	3,673	3,236		

3 thin disc bases: **CH** **SH**  
NA +195



Top Size	Base	Model Number	3P	3K	3W	W1-W4	F1-F5	Rectangular with 3 disc bases	<i>NEW</i>
42 x 120	Static	44TC42120D32(3)	\$3,177	\$3,556	\$3,646	\$3,862	\$3,708		
42 x 144	Static	44TC42144D32(3)	3,333	3,774	3,872	4,143	3,729		

3 disc base: **CH** **SH**  
+1200 +195



Top Size	Base	Model Number	3P	3K	3W	W1-W4	F1-F5	Rectangular with 3 drum bases	<i>NEW</i>
42 x 120	Drum	44TC42120DR24(3)	\$6,195	\$6,573	\$6,663	\$6,879	\$6,876		
42 x 144	Drum	44TC42144DR24(3)	6,350	6,791	6,889	7,160	6,897		
48 x 120	Drum	44TC48120DR24(3)	6,204	6,587	6,688	7,017	6,929		
48 x 144	Drum	44TC48144DR24(3)	6,361	6,806	6,916	7,317	6,982		

drum bases: **CH** **SH**  
NA NA



- LC**  
NA
- QC**  
NA
- CH**  
NA
- WM**  
+125
- WMLC**  
+45
- WMLC**  
NA
- SH**  
+195
- FR**  
+450
- PB**  
NA
- GR**  
+40
- CM**  
+50
- RC**  
+55
- GN**  
+40
- LT**  
+115
- AH**  
NA
- NU**  
NA

NEW

Boat-Shaped with 2 thin disc bases	Top Size	Base	Model Number	3P	3K	3W	W1-W4	F1-F5
	30 x 42 x 84	Static	99BT3084D24	\$ 1,716	\$2,022	\$2,042	\$ 2,761	\$ 1,582
	30 x 42 x 90	Static	99BT3090D24	1,893	2,242	2,243	2,929	1,902
	30 x 42 x 96	Static	99BT3096D24	1,893	2,242	2,257	3,026	1,914
	36 x 48 x 84	Static	99BT3684D32	2,019	2,367	2,363	3,098	2,022
	36 x 48 x 90	Static	99BT3690D32	2,210	2,608	2,580	3,270	2,146
	36 x 48 x 96	Static	99BT3696D32	2,210	2,608	2,594	3,371	2,158

2 thin disc bases: **CH** **SH**  
NA +130

NEW

Boat-Shaped with 2 disc bases	Top Size	Base	Model Number	3P	3K	3W	W1-W4	F1-F5
	30 x 42 x 84	Static	44BT3084D24	\$ 1,970	\$2,276	\$2,296	\$ 3,015	\$ 1,849
	30 x 42 x 90	Static	44BT3090D24	2,147	2,495	2,497	3,183	2,168
	30 x 42 x 96	Static	44BT3096D24	2,147	2,495	2,511	3,279	2,181
	36 x 48 x 84	Static	44BT3684D32	2,332	2,680	2,676	3,412	2,351
	36 x 48 x 90	Static	44BT3690D32	2,523	2,921	2,893	3,584	2,475
	36 x 48 x 96	Static	44BT3696D32	2,523	2,921	2,907	3,684	2,487

2 disc base: **CH** **SH**  
+800 +130

NEW

Boat-Shaped with 2 drum bases	Top Size	Base	Model Number	3P	3K	3W	W1-W4	F1-F5
	30 x 42 x 84	Drum	44BT3084DR18	\$ 4,032	\$ 4,337	\$ 4,358	\$ 5,077	\$ 4,014
	30 x 42 x 90	Drum	44BT3090DR18	4,208	4,557	4,559	5,245	4,333
	30 x 42 x 96	Drum	44BT3096DR18	4,208	4,557	4,572	5,341	4,346
	36 x 48 x 84	Drum	44BT3684DR24	4,343	4,691	4,687	5,423	4,463
	36 x 48 x 90	Drum	44BT3690DR24	4,534	4,932	4,905	5,595	4,587
	36 x 48 x 96	Drum	44BT3696DR24	4,534	4,932	4,919	5,695	4,599

drum bases: **CH** **SH**  
NA NA

Primary

- LC**  
NA
- QC**  
NA
- CH**  
NA
- WM**  
+125
- WMLC**  
+45
- WMLC**  
NA
- SH**  
+130
- FR**  
+300
- PB**  
NA
- GR**  
+40
- CM**  
+50
- RC**  
+55
- GN**  
NA
- LT**  
NA
- AH**  
NA
- NU**  
NA

Top Size	Base	Model Number	3P	3K	3W	W1-W4	F1-F5	Boat-Shaped with 3 thin disc bases
36 x 48 x 120	Static	99BT36120D243224	\$2,960	\$3,518	\$3,440	\$4,128	3,063	
36 x 48 x 144	Static	99BT36144D243224	3,206	3,863	3,766	4,540	3,116	

3 thin disc bases: **CH** **SH**  
NA +195



Top Size	Base	Model Number	3P	3K	3W	W1-W4	F1-F5	Boat-Shaped with 3 disc bases
36 x 48 x 120	Static	44BT36120D243224	\$3,370	\$3,928	\$3,850	\$4,539	3,494	
36 x 48 x 144	Static	44BT36144D243224	3,617	4,273	4,177	4,951	3,547	

3 disc base: **CH** **SH**  
+1200 +195





Top Size	Base	Model Number	3P	3K	3W	W1-W4	F1-F5	Boat-Shaped with 3 drum bases
36 x 48 x 120	Drum	44BT36120DR182418	\$6,438	\$6,995	\$6,917	\$7,606	6,715	
36 x 48 x 144	Drum	44BT36144DR182418	6,684	7,341	7,244	8,018	6,768	



drum bases: **CH** **SH**  
NA NA



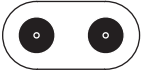

- LC**  
NA
- QC**  
NA
- CH**  
NA
- WM**  
+125
- WMLC**  
+45
- WMLC**  
NA
- SH**  
+195
- FR**  
+450
- PB**  
NA
- GR**  
+40
- CM**  
+50
- RC**  
+55
- GN**  
NA
- LT**  
NA
- AH**  
NA
- NU**  
NA

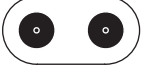
**NEW**

Racetrack with 2 thin disc bases	Top Size	Base	Model Number	3P	3K	3W	W1-W4	F1-F5
  <p>2 thin disc bases: <b>CH</b> <b>SH</b> NA +130</p>	36 x 72	Static	99RT3672D20	\$ 1,457	\$ 1,683	\$ 1,727	\$ 2,379	\$ 1,717
	36 x 84	Static	99RT3684D20	1,552	1,815	1,859	2,564	1,743
	36 x 90	Static	99RT3690D20	1,742	2,055	2,076	2,724	1,827
	36 x 96	Static	99RT3696D20	1,742	2,055	2,089	2,813	1,833
	42 x 84	Static	99RT4284D24	1,714	2,018	2,039	2,761	1,805
	42 x 90	Static	99RT4290D24	1,893	2,242	2,243	2,929	1,902
	42 x 96	Static	99RT4296D24	1,893	2,242	2,257	3,026	1,914
	48 x 84	Static	99RT4884D32	2,142	2,539	2,498	3,098	2,022
	48 x 90	Static	99RT4890D32	2,210	2,608	2,580	3,270	2,144
	48 x 96	Static	99RT4896D32	2,210	2,608	2,594	3,371	2,157

Racetrack with 2 disc bases	Top Size	Base	Model Number	3P	3K	3W	W1-W4	F1-F5
  <p>2 disc base: <b>CH</b> <b>SH</b> +800 +130</p>	36 x 72	Static	44RT3672D20	\$ 1,691	\$ 1,916	\$ 1,961	\$ 2,612	\$ 1,962
	36 x 84	Static	44RT3684D20	1,785	2,049	2,093	2,797	1,988
	36 x 90	Static	44RT3690D20	1,976	2,288	2,309	2,957	2,072
	36 x 96	Static	44RT3696D20	1,976	2,288	2,323	3,046	2,078
	42 x 84	Static	44RT4284D24	1,968	2,272	2,293	3,015	2,071
	42 x 90	Static	44RT4290D24	2,147	2,495	2,497	3,183	2,168
	42 x 96	Static	44RT4296D24	2,147	2,495	2,511	3,279	2,181
	48 x 84	Static	44RT4884D32	2,455	2,853	2,811	3,412	2,351
	48 x 90	Static	44RT4890D32	2,523	2,921	2,893	3,584	2,473
	48 x 96	Static	44RT4896D32	2,523	2,921	2,907	3,684	2,486

**NEW**

Racetrack with 2 drum bases	Top Size	Base	Model Number	3P	3K	3W	W1-W4	F1-F5
  <p>drum bases: <b>CH</b> <b>SH</b> NA NA</p>	36 x 72	Drum	44RT3672DR18	\$ 3,832	\$ 4,058	\$ 4,102	\$ 4,754	\$ 4,211
	36 x 84	Drum	44RT3684DR18	3,927	4,190	4,234	4,938	4,236
	36 x 90	Drum	44RT3690DR18	4,117	4,429	4,450	5,099	4,320
	36 x 96	Drum	44RT3696DR18	4,117	4,429	4,464	5,187	4,327
	42 x 84	Drum	44RT4284DR18	4,029	4,334	4,355	5,077	4,236
	42 x 90	Drum	44RT4290DR18	4,208	4,557	4,559	5,245	4,333
	42 x 96	Drum	44RT4296DR18	4,208	4,557	4,572	5,341	4,346
	48 x 84	Drum	44RT4884DR24	4,466	4,864	4,823	5,423	4,463
	48 x 90	Drum	44RT4890DR24	4,534	4,932	4,905	5,595	4,585
	48 x 96	Drum	44RT4896DR24	4,534	4,932	4,919	5,695	4,598

Primary

- LC**  
NA
- QC**  
NA
- CH**  
NA
- WM**  
+125
- WMLC**  
+45
- WMLC**  
NA
- SH**  
+130
- FR**  
+300
- PB**  
NA
- GR**  
+40
- CM**  
+50
- RC**  
NA
- GN**  
NA
- LT**  
NA
- AH**  
NA
- NU**  
NA



Top Size	Base	Model Number	3P	3K	3W	W1-W4	F1-F5	Racetrack with 3 thin disc bases
42 x 120	Static	99RT42120D24(3)	\$2,849	\$3,401	\$3,319	\$3,858	\$2,908	
42 x 144	Static	99RT42144D24(3)	3,093	3,743	3,643	4,246	2,929	
48 x 120	Static	99RT48120D32(3)	3,155	3,713	3,635	4,323	3,268	
48 x 144	Static	99RT48144D32(3)	3,402	4,058	3,962	4,735	3,321	

3 thin disc bases: **CH** **SH**  
NA +195

Top Size	Base	Model Number	3P	3K	3W	W1-W4	F1-F5	Racetrack with 3 disc bases
42 x 120	Static	44RT42120D24(3)	\$3,230	\$3,782	\$3,700	\$4,239	\$3,308	
42 x 144	Static	44RT42144D24(3)	3,474	4,124	4,024	4,627	3,329	
48 x 120	Static	44RT48120D32(3)	3,625	4,183	4,105	4,793	3,761	
48 x 144	Static	44RT48144D32(3)	3,871	4,528	4,431	5,205	3,814	



3 disc base: **CH** **SH**  
+1200 +195

Top Size	Base	Model Number	3P	3K	3W	W1-W4	F1-F5	Racetrack with 3 drum bases
42 x 120	Drum	44RT42120DR18(3)	\$6,322	\$6,875	\$6,793	\$7,331	\$6,555	
42 x 144	Drum	44RT42144DR18(3)	6,566	7,216	7,117	7,720	6,576	
48 x 120	Drum	44RT48120DR24(3)	6,642	7,200	7,122	7,810	6,929	
48 x 144	Drum	44RT48144DR24(3)	6,888	7,545	7,448	8,222	6,982	



drum bases: **CH** **SH**  
NA NA

- LC**  
NA
- QC**  
NA
- CH**  
NA
- WM**  
+125
- WMLC**  
+45
- WMLC**  
NA
- SH**  
+195
- FR**  
+450
- PB**  
NA
- GR**  
+40
- CM**  
+50
- RC**  
NA
- GN**  
NA
- LT**  
NA
- AH**  
NA
- NU**  
NA



**NEW**

Elliptical with 2 thin disc bases	Top Size	Base	Model Number	3P	3K	3W	W1-W4	F1-F5
  <p>2 thin disc bases: <b>CH</b> <b>SH</b> NA +130</p>	36 x 72	Static	99EL3672D20	\$ 1,457	\$ 1,683	\$ 1,710	\$ 2,379	\$ 1,587
	36 x 84	Static	99EL3684D20	1,552	1,815	1,836	2,564	1,608
	36 x 90	Static	99EL3690D20	1,742	2,055	2,049	2,724	1,726
	36 x 96	Static	99EL3696D20	1,742	2,055	2,060	2,813	1,751
	42 x 72	Static	99EL4272D24	1,611	1,875	1,884	2,569	1,649
	42 x 84	Static	99EL4284D24	1,714	2,018	2,018	2,761	1,670
	42 x 90	Static	99EL4290D24	1,895	2,244	2,221	2,929	1,763
	42 x 96	Static	99EL4296D24	1,895	2,244	2,232	3,026	1,773
	48 x 84	Static	99EL4884D32	1,940	2,257	2,259	3,098	1,986
	48 x 90	Static	99EL4890D32	2,210	2,608	2,560	3,270	2,100
	48 x 96	Static	99EL4896D32	2,210	2,608	2,571	3,371	2,111

**NEW**

Elliptical with 2 disc bases	Top Size	Base	Model Number	3P	3K	3W	W1-W4	F1-F5
  <p>2 disc base: <b>CH</b> <b>SH</b> +800 +130</p>	36 x 72	Static	44EL3672D20	\$ 1,691	\$ 1,916	\$ 1,943	\$ 2,612	\$ 1,832
	36 x 84	Static	44EL3684D20	1,785	2,049	2,069	2,797	1,853
	36 x 90	Static	44EL3690D20	1,976	2,288	2,282	2,957	1,971
	36 x 96	Static	44EL3696D20	1,976	2,288	2,293	3,046	1,996
	42 x 72	Static	44EL4272D24	1,865	2,128	2,138	2,823	1,916
	42 x 84	Static	44EL4284D24	1,968	2,272	2,272	3,015	1,937
	42 x 90	Static	44EL4290D24	2,149	2,498	2,475	3,183	2,030
	42 x 96	Static	44EL4296D24	2,149	2,498	2,486	3,279	2,040
	48 x 84	Static	44EL4884D32	2,253	2,570	2,572	3,412	2,315
	48 x 90	Static	44EL4890D32	2,523	2,921	2,873	3,584	2,429
	48 x 96	Static	44EL4896D32	2,523	2,921	2,884	3,684	2,440

**NEW**

Elliptical with 2 drum bases	Top Size	Base	Model Number	3P	3K	3W	W1-W4	F1-F5
  <p>drum bases: <b>CH</b> <b>SH</b> NA NA</p>	36 x 72	Drum	44EL3672DR18	\$ 3,832	\$ 4,058	\$ 4,084	\$ 4,754	\$ 4,080
	36 x 84	Drum	44EL3684DR18	3,927	4,190	4,210	4,938	4,102
	36 x 90	Drum	44EL3690DR18	4,117	4,429	4,423	5,099	4,219
	36 x 96	Drum	44EL3696DR18	4,117	4,429	4,434	5,187	4,245
	42 x 72	Drum	44EL4272DR18	3,927	4,190	4,199	4,884	4,080
	42 x 84	Drum	44EL4284DR18	4,029	4,334	4,334	5,077	4,102
	42 x 90	Drum	44EL4290DR18	4,210	4,560	4,537	5,245	4,194
	42 x 96	Drum	44EL4296DR18	4,210	4,560	4,548	5,341	4,205
	48 x 84	Drum	44EL4884DR24	4,265	4,582	4,583	5,423	4,427
	48 x 90	Drum	44EL4890DR24	4,535	4,933	4,885	5,595	4,541
	48 x 96	Drum	44EL4896DR24	4,535	4,933	4,895	5,695	4,551

Primary

- LC**  
NA
- QC**  
NA
- CH**  
NA
- WM**  
+125
- WMLC**  
+45
- WMLC**  
NA
- SH**  
+130
- FR**  
+300
- PB**  
NA
- GR**  
+40
- CM**  
+50
- RC**  
NA
- GN**  
NA
- LT**  
NA
- AH**  
NA
- NU**  
NA

Top Size	Base	Model Number	3P	3K	3W	W1-W4	F1-F5	Elliptical with 3 thin disc bases
42 x 120	Static	99EL42120D202420	\$2,790	\$3,342	\$3,222	\$3,799	2,846	
42 x 144	Static	99EL42144D202420	3,034	3,684	3,534	4,187	2,867	
48 x 120	Static	99EL48120D243224	2,960	3,518	3,404	4,128	3,063	
48 x 144	Static	99EL48144D243224	3,207	3,863	3,719	4,540	3,116	

3 thin disc bases: **CH** **SH**  
NA +195



Top Size	Base	Model Number	3P	3K	3W	W1-W4	F1-F5	Elliptical with 3 disc bases
42 x 120	Static	44EL42120D202420	\$3,150	\$3,703	\$3,582	\$4,159	3,224	
42 x 144	Static	44EL42144D202420	3,394	4,044	3,894	4,548	3,245	
48 x 120	Static	44EL48120D243224	3,371	3,929	3,815	4,539	3,494	
48 x 144	Static	44EL48144D243224	3,617	4,274	4,130	4,951	3,547	

3 disc bases: **CH** **SH**  
+1200 +195



Top Size	Base	Model Number	3P	3K	3W	W1-W4	F1-F5	Elliptical with 3 drum bases
42 x 120	Drum	44EL42120DR182418	\$6,424	\$6,977	\$6,856	\$7,433	6,662	
42 x 144	Drum	44EL42144DR182418	6,668	7,318	7,168	7,822	6,683	
48 x 120	Drum	44EL48120DR182418	6,438	6,996	6,882	7,606	6,715	
48 x 144	Drum	44EL48144DR182418	6,685	7,341	7,197	8,018	6,768	



drum bases: **CH** **SH**  
NA NA

- LC**  
NA
- QC**  
NA
- CH**  
NA
- WM**  
+125
- WMLC**  
+45
- WMLC**  
NA
- SH**  
+195
- FR**  
+450
- PB**  
NA
- GR**  
+40
- CM**  
+50
- RC**  
NA
- GN**  
NA
- LT**  
NA
- AH**  
NA
- NU**  
NA



Square with column bases	Top Size	Base	Model Number	3P	3K	3W	W1-W4	F1-F5
 	24 x 24	Static	44SQ2424C2	\$ 478	\$ 517	\$ 599	\$ 729	\$ 528
	30 x 30	Static	44SQ3030C2	530	589	683	840	584
	36 x 36	Static	44SQ3636C2	592	676	779	964	733
	42 x 42	Static	44SQ4242C2	666	779	888	1,098	755
	48 x 48	Static	44SQ4848C2	750	897	1,008	1,241	776
	54 x 54	Static	44SQ5454C2	845	1,030	1,141	1,395	NA
	60 x 60	Static	44SQ6060C2	951	1,179	1,285	1,560	NA

NEW

Square with thin square disc base	Top Size	Base	Model Number	3P	3K	3W	W1-W4	F1-F5
  <b>BL • BLS</b>  Counterbalanced & Short Balanced Height Adj.  thin disc base: <b>CH</b> <b>SH</b> <b>NU</b> NA +65 NA	24 x 24	Static	99SQ2424QD16	\$ 572	\$ 610	\$ 692	\$ 822	\$ 626
	30 x 30	Static	99SQ2424QD16BLS	993	1,031	1,113	1,243	1,068
		Short Bal	99SQ3030QD16	623	682	776	934	682
	36 x 36	Static	99SQ3030QD16BLS	1,044	1,103	1,198	1,355	1,124
		Short Bal	99SQ3636QD20	715	799	902	1,086	862
		Count Bal	99SQ3636QD20BLS	1,358	1,441	1,545	1,729	1,537
	42 x 42	Static	99SQ3636QD20BL	1,358	1,441	1,545	1,729	1,537
		Short Bal	99SQ4242QD26	886	999	1,108	1,318	986
		Count Bal	99SQ4242QD26BLS	1,520	1,633	1,742	1,953	1,652
	42 x 42	Short Bal	99SQ4242QD26BL	1,520	1,633	1,742	1,953	1,652
		Count Bal	99SQ4242QD26BL	1,520	1,633	1,742	1,953	1,652

Square with disc base	Top Size	Base	Model Number	3P	3K	3W	W1-W4	F1-F5
  <b>BL • BLS</b>  Counterbalanced & Short Balanced Height Adj.  disc base: <b>CH</b> <b>SH</b> +400 +65	24 x 24	Static	44SQ2424D20	\$ 688	\$ 727	\$ 809	\$ 939	\$ 748
	30 x 30	Static	44SQ2424D20BLS	1,086	1,124	1,206	1,336	1,166
		Short Bal	44SQ3030D24	779	838	933	1,090	846
	36 x 36	Static	44SQ3030D24BLS	1,386	1,445	1,540	1,697	1,484
		Short Bal	44SQ3636D24	842	926	1,029	1,213	996
		Count Bal	44SQ3636D24BLS	1,449	1,533	1,636	1,820	1,633
	42 x 42	Static	44SQ3636D24BL	1,449	1,533	1,636	1,820	1,633
		Short Bal	44SQ4242D32	1,042	1,155	1,264	1,475	1,150
		Count Bal	44SQ4242D32BLS	1,638	1,751	1,860	2,070	1,775
	42 x 42	Short Bal	44SQ4242D32BL	1,638	1,751	1,860	2,070	1,775
		Count Bal	44SQ4242D32BL	1,638	1,751	1,860	2,070	1,775

NEW

Square with drum base	Top Size	Base	Model Number	3P	3K	3W	W1-W4	F1-F5
  drum bases: <b>CH</b> <b>SH</b> NA NA	30 x 30	Drum	44SQ3030DR18	\$ 1,810	\$ 1,869	\$ 1,964	\$ 2,121	\$ 1,929
	36 x 36	Drum	44SQ3636DR18	1,873	1,956	2,060	2,244	2,078
	42 x 42	Drum	44SQ4242DR24	2,048	2,161	2,270	2,481	2,206
	48 x 48	Drum	44SQ4848DR24	2,132	2,279	2,391	2,623	2,227
	54 x 54	Drum	44SQ5454DR28	2,560	2,745	2,856	3,109	NA
	60 x 60	Drum	44SQ6060DR28	2,666	2,894	3,000	3,275	NA
		Drum	44SQ6060DR28	2,666	2,894	3,000	3,275	NA

Primary

- LC**  
+90
- QC**  
+140
- CH**  
+100
- WM**  
+125
- WMLC**  
+45
- MLLC**  
+55
- SH**  
D+65  
C+260
- FR**  
+150
- PB**  
+55
- GR**  
+40
- CM**  
+50
- RC**  
+55
- GN**  
+40
- LT**  
+115
- AH**  
D+125  
C+500
- NU**  
D+350

Top Size	Base	Model Number	3P	3K	3W	W1-W4	F1-F5	Round with column bases
24 x 24	Static	44RD24C2	\$ 510	\$ 561	\$ 610	\$ 937	\$ 528	
30 x 30	Static	44RD30C2	580	659	709	1,117	584	
36 x 36	Static	44RD36C2	654	762	811	1,318	733	
42 x 42	Static	44RD42C2	751	899	940	1,537	755	
48 x 48	Static	44RD48C2	779	937	992	1,775	776	
54 x 54	Static	44RD54C2	938	1,160	1,189	2,037	NA	
60 x 60	Static	44RD60C2	960	1,191	1,236	2,314	NA	

Top Size	Base	Model Number	3P	3K	3W	W1-W4	F1-F5	Round with thin disc base <b>NEW</b>
24 x 24	Static	99RD24D20	\$ 603	\$ 654	\$ 703	\$ 1,030	\$ 626	<p><b>BL • BLS</b></p> <p>Counterbalanced &amp; Short Balanced Height Adj.</p> <p>thin disc base: <b>CH</b> <b>SH</b> <b>NU</b> NA +65 NA</p>
	Short Bal	99RD24D20BLS	1,025	1,076	1,124	1,451	1,068	
30 x 30	Static	99RD30D20	673	752	802	1,211	682	
	Short Bal	99RD30D20BLS	1,094	1,173	1,223	1,632	1,124	
36 x 36	Static	99RD36D20	747	855	904	1,411	831	
	Short Bal	99RD36D20BLS	1,168	1,277	1,326	1,832	1,274	
	Count Bal	99RD36D20BL	1,168	1,277	1,326	1,832	1,274	
42 x 42	Static	99RD42D24	874	1,021	1,063	1,660	883	
	Short Bal	99RD42D24BLS	1,517	1,664	1,706	2,302	1,558	
	Count Bal	99RD42D24BL	1,517	1,664	1,706	2,302	1,558	
48 x 48	Static	99RD48D32	999	1,157	1,212	1,996	1,007	
	Short Bal	99RD48D32BLS	1,633	1,792	1,847	2,630	1,673	
	Count Bal	99RD48D32BL	1,633	1,792	1,847	2,630	1,673	

Top Size	Base	Model Number	3P	3K	3W	W1-W4	F1-F5	Round with disc base
24 x 24	Static	44RD24D20	\$ 720	\$ 771	\$ 820	\$ 1,146	\$ 748	<p><b>BL • BLS</b></p> <p>Counterbalanced &amp; Short Balanced Height Adj.</p> <p>disc base: <b>CH</b> <b>SH</b> +400 +65</p>
	Short Bal	44RD24D20BLS	1,118	1,169	1,218	1,544	1,166	
30 x 30	Static	44RD30D20	790	869	918	1,327	804	
	Short Bal	44RD30D20BLS	1,188	1,267	1,316	1,725	1,222	
36 x 36	Static	44RD36D20	863	972	1,021	1,527	954	
	Short Bal	44RD36D20BLS	1,261	1,370	1,419	1,925	1,372	
	Count Bal	44RD36D20BL	1,261	1,370	1,419	1,925	1,372	
42 x 42	Static	44RD42D24	1,001	1,148	1,190	1,787	1,017	
	Short Bal	44RD42D24BLS	1,608	1,755	1,797	2,394	1,654	
	Count Bal	44RD42D24BL	1,608	1,755	1,797	2,394	1,654	
48 x 48	Static	44RD48D32	1,155	1,314	1,369	2,152	1,171	
	Short Bal	44RD48D32BLS	1,751	1,909	1,964	2,747	1,796	
	Count Bal	44RD48D32BL	1,751	1,909	1,964	2,747	1,796	

Top Size	Base	Model Number	3P	3K	3W	W1-W4	F1-F5	Round with drum base <b>NEW</b>
30 x 30	Drum	44RD30DR18	\$ 1,860	\$ 1,939	\$ 1,989	\$ 2,398	\$ 1,929	<p>drum bases: <b>CH</b> <b>SH</b> NA NA</p>
36 x 36	Drum	44RD36DR18	1,934	2,043	2,092	2,598	2,078	
42 x 42	Drum	44RD42DR24	2,134	2,281	2,323	2,919	2,206	
48 x 48	Drum	44RD48DR24	2,161	2,319	2,375	3,158	2,227	
54 x 54	Drum	44RD54DR24	2,320	2,543	2,572	3,419	NA	
60 x 60	Drum	44RD60DR28	2,675	2,906	2,950	4,029	NA	

- LC**  
+90
- QC**  
+140
- CH**  
+100
- WM**  
+125
- WMLC**  
+45
- WMLC**  
+55
- SH**  
D+65  
C+260
- FR**  
+150
- PB**  
+55
- GR**  
+40
- CM**  
+50
- RC**  
NA
- GN**  
NA
- LT**  
NA
- AH**  
D+125  
C+500
- NU**  
D+350

D-shaped with column bases	Top Size	Base	Model Number	3P	3K	3W	W1-W4	F1-F5
	24 x 36	Static	44D2436C2	\$ 570	\$ 645	\$ 715	\$ 1,006	\$ 618
	24 x 48	Static	44D2448C2	632	732	812	1,141	690
	24 x 60	Static	44D2460C2	695	820	908	1,275	763
	24 x 72	Static	44D2472C2	757	907	1,005	1,410	836
	24 x 84	Static	44D2484C2	888	1,063	1,169	1,613	981
	24 x 90	Static	44D2490C2	919	1,107	1,217	1,682	1,017
	24 x 96	Static	44D2496C2	951	1,151	1,266	1,751	1,054
	30 x 48	Static	44D3048C2	695	820	891	1,237	763
	30 x 60	Static	44D3060C2	773	929	1,005	1,383	833
	30 x 72	Static	44D3072C2	851	1,039	1,119	1,529	946
	30 x 84	Static	44D3084C2	998	1,216	1,301	1,744	1,108
	30 x 90	Static	44D3090C2	1,036	1,271	1,357	1,817	1,154
	30 x 96	Static	44D3096C2	1,076	1,325	1,414	1,890	1,200
	36 x 48	Static	44D3648C2	757	907	971	1,333	836
	36 x 60	Static	44D3660C2	851	1,039	1,102	1,491	946
	36 x 72	Static	44D3672C2	945	1,170	1,233	1,645	1,050
	36 x 84	Static	44D3684C2	1,107	1,369	1,432	1,871	1,143
	36 x 90	Static	44D3690C2	1,154	1,435	1,497	1,951	1,297
	36 x 96	Static	44D3696C2	1,200	1,500	1,562	2,028	1,307

NEW

D-shaped with 2 drum bases	Top Size	Base	Model Number	3P	3K	3W	W1-W4	F1-F5
	30 x 60	Drum	44D3060DR18	\$3,659	\$3,815	\$3,891	\$4,269	\$3,863
	30 x 72	Drum	44D3072DR18	3,737	3,924	4,004	4,415	3,976
	30 x 84	Drum	44D3084DR18	3,883	4,102	4,186	4,629	4,138
	30 x 90	Drum	44D3090DR18	3,922	4,157	4,243	4,702	4,184
	30 x 96	Drum	44D3096DR18	3,961	4,211	4,300	4,775	4,230
	36 x 72	Drum	44D3672DR18	3,831	4,056	4,118	4,530	4,080
	36 x 84	Drum	44D3684DR18	3,992	4,255	4,317	4,756	4,173
	36 x 90	Drum	44D3690DR18	4,039	4,321	4,383	4,837	4,327
	36 x 96	Drum	44D3696DR18	4,086	4,386	4,448	4,914	4,337
	42 x 72	Drum	44D4272DR24	4,128	4,391	4,436	4,853	4,294
	42 x 84	Drum	44D4284DR24	4,406	4,753	4,763	5,087	4,387
	42 x 90	Drum	44D4290DR24	4,468	4,839	4,845	5,172	4,408
	42 x 96	Drum	44D4296DR24	4,530	4,926	4,927	5,256	4,551
	48 x 72	Drum	44D4872DR24	4,222	4,522	4,550	4,969	4,406
	48 x 84	Drum	44D4884DR24	4,415	4,765	4,783	5,218	4,499
	48 x 90	Drum	44D4890DR24	4,477	4,852	4,866	5,395	4,541
	48 x 96	Drum	44D4896DR24	4,540	4,940	4,949	5,395	4,551

drum bases: **CH** **SH**  
quote NA

Primary

- LC**  
+90
- QC**  
+140
- CH**  
+100
- WM**  
+125
- WMLC**  
+45
- MMLC**  
+55
- SH**  
+260
- FR**  
NA
- PB**  
NA
- GR**  
+40
- CM**  
+50
- RC**  
+55
- GN**  
+40
- LT**  
NA
- AH**  
+500
- NU**  
NA

Top Size	Base	Model Number	3P	3K	3W	W1-W4	F1-F5	D-shaped with 2 thin disc bases	<b>NEW</b>
24 x 60	Static	99D2460D20	\$ 1,206	\$ 1,331	\$ 1,419	\$ 1,786	\$ 1,300		
24 x 72	Static	99D2472D20	1,269	1,419	1,516	1,921	1,373		
24 x 84	Static	99D2484D20	1,399	1,574	1,680	2,124	1,517		
24 x 90	Static	99D2490D20	1,430	1,618	1,729	2,193	1,554		
24 x 96	Static	99D2496D20	1,462	1,662	1,777	2,262	1,590		
30 x 60	Static	99D3060D20	1,284	1,441	1,516	1,894	1,370		
30 x 72	Static	99D3072D20	1,362	1,550	1,630	2,040	1,482		
30 x 84	Static	99D3084D20	1,509	1,727	1,812	2,255	1,645		
30 x 90	Static	99D3090D20	1,548	1,782	1,868	2,328	1,691		
30 x 96	Static	99D3096D20	1,587	1,837	1,925	2,401	1,736		
36 x 72	Static	99D3672D24	1,515	1,740	1,803	2,215	1,649		
36 x 84	Static	99D3684D24	1,677	1,939	2,002	2,441	1,742		
36 x 90	Static	99D3690D24	1,724	2,005	2,067	2,521	1,896		
36 x 96	Static	99D3696D24	1,771	2,071	2,133	2,598	1,906		
42 x 72	Static	99D4272D32	1,804	2,066	2,112	2,529	1,854		
42 x 84	Static	99D4284D32	2,082	2,428	2,438	2,763	1,946		
42 x 90	Static	99D4290D32	2,144	2,515	2,521	2,847	1,968		
42 x 96	Static	99D4296D32	2,206	2,602	2,602	2,932	2,111		

2 thin disc bases: **CH** **SH**  
NA +130

Top Size	Base	Model Number	3P	3K	3W	W1-W4	F1-F5	D-shaped with 2 disc bases	<b>NEW</b>
24 x 60	Static	44D2460D20	\$ 1,439	\$ 1,564	\$ 1,653	\$ 2,020	\$ 1,545		
24 x 72	Static	44D2472D20	1,502	1,652	1,749	2,154	1,618		
24 x 84	Static	44D2484D20	1,632	1,807	1,914	2,357	1,762		
24 x 90	Static	44D2490D20	1,664	1,851	1,962	2,426	1,799		
24 x 96	Static	44D2496D20	1,695	1,895	2,010	2,496	1,835		
30 x 60	Static	44D3060D20	1,518	1,674	1,750	2,127	1,614		
30 x 72	Static	44D3072D20	1,596	1,783	1,863	2,274	1,727		
30 x 84	Static	44D3084D20	1,742	1,961	2,045	2,488	1,890		
30 x 90	Static	44D3090D20	1,781	2,015	2,102	2,561	1,936		
30 x 96	Static	44D3096D20	1,820	2,070	2,158	2,634	1,981		
36 x 72	Static	44D3672D24	1,769	1,994	2,057	2,469	1,916		
36 x 84	Static	44D3684D24	1,931	2,193	2,256	2,695	2,008		
36 x 90	Static	44D3690D24	1,978	2,259	2,321	2,775	2,162		
36 x 96	Static	44D3696D24	2,025	2,325	2,387	2,852	2,173		
42 x 72	Static	44D4272D32	2,117	2,379	2,425	2,842	2,182		
42 x 84	Static	44D4284D32	2,395	2,741	2,751	3,076	2,275		
42 x 90	Static	44D4290D32	2,457	2,828	2,834	3,160	2,296		
42 x 96	Static	44D4296D32	2,519	2,915	2,915	3,245	2,440		

2 disc base: **CH** **SH**  
+800 +130

Primary

- LC**  
NA
- QC**  
NA
- CH**  
NA
- WM**  
+125
- WMLC**  
+45
- WMLC**  
NA
- SH**  
+130
- FR**  
+300
- PB**  
NA
- GR**  
+40
- CM**  
+50
- RC**  
+55
- GN**  
+40
- LT**  
NA
- AH**  
NA
- NU**  
NA

Half Round with column bases	Top Size	Base	Model Number	3P	3K	3W	W1-W4	F1-F5
	18 x 36	Static	44HR1836C2(3)	\$ 497	\$ 576	\$ 624	\$ 1,075	\$ 478
	24 x 48	Static	44HR2448C2(3)	554	655	722	1,375	605
	30 x 60	Static	44HR3060C2	774	931	992	1,775	855
	36 x 72	Static	44HR3672C2	944	1,168	1,214	2,122	1,055

Crescent with column bases	Top Size	Base	Model Number	3P	3K	3W	W1-W4	F1-F5
	24 x 48 x 75	Static	44CS2475C2	\$ 1,245	\$ 1,563	\$ 1,511	\$ 1,847	\$ 1,613
	24 x 60 x 94	Static	44CS2494C2	1,568	2,016	1,916	2,124	1,613
	30 x 60 x 94	Static	44CS3094C2	1,568	2,016	1,913	2,282	1,613

Trapezoid with column bases	Top Size	Base	Model Number	3P	3K	3W	W1-W4	F1-F5
	24 x 48	Static	44TZ2448C2	\$ 627	\$ 725	\$ 790	\$ 1,237	\$ 690
	24 x 72	Static	44TZ2472C2	854	1,015	1,088	1,643	908
	30 x 60	Static	44TZ3060C2	801	941	1,009	1,613	926
	36 x 72	Static	44TZ3672C2	990	1,205	1,251	1,955	1,127

Corner with column bases	Top Size	Base	Model Number	3P	3K	3W	W1-W4	F1-F5
	24 x 42	Static	44CR2442C2(5)	\$ 884	\$ 1,052	\$ 1,111	\$ 1,768	\$ 739
	30 x 48	Static	44CR3048C2(5)	917	1,098	1,175	2,041	849

5 bases: **LC** **QC** **SH** **CH**  
 +113 +175 +325 +125

Primary

- LC**  
+90
- QC**  
+140
- CH**  
+100
- WM**  
+125
- WMLC**  
+45
- MMLC**  
+55
- SH**  
+260
- FR**  
NA
- PB**  
NA
- GR**  
+40
- CM**  
+50
- RC**  
+55
- GN**  
+40
- LT**  
+115
- AH**  
+500
- NU**  
NA



Top Size	Base	Model Number	3P	3K	3W	W1-W4	F1-F5	Arc Segment with column bases
20 x 44	Static	44AS2044C2	\$ 660	\$ 771	\$ 803	NA	\$ 622	
24 x 51	Static	44AS2451C2	730	868	896	NA	715	
30 x 59	Static	44AS3059C2	867	1,034	1,065	NA	926	
36 x 67	Static	44AS3667C2	1,034	1,267	1,290	NA	1,127	

Top Size	Base	Model Number	3P	3K	3W	W1-W4	F1-F5	Ganging Quarter Round (with column*)
20 x 20	Ganging	QR2020GN	\$ 224	\$ 272	\$ 319	NA	\$ 236	
24 x 24	Ganging	QR2424GN	233	284	344	NA	236	
30 x 30	Static, GN	44QR3030GNC2	382	461	526	NA	377	
	Ganging	QR3030GN	301	380	444	NA	292	
36 x 36	Static, GN	44QR3636GNC2	446	551	621	NA	527	
	Ganging	QR3636GN	365	469	540	NA	442	

1 column base: **LC** **QC** **CH** **SH**  
 NA +35 +25 +65



Top Size	Base	Model Number	3P	3K	3W	W1-W4	F1-F5	Ganging 45° Wedge (with column*)
20 x 20	Ganging	WG45D20GN	\$ 224	\$ 272	\$ 315	NA	\$ 236	
24 x 24	Ganging	WG45D24GN	233	284	337	NA	236	
30 x 30	Ganging	WG45D30GN	301	380	432	NA	292	
36 x 36	Static, GN	44WG45D36GNC2	446	551	602	NA	527	
	Ganging	WG45D36GN	365	469	520	NA	442	

1 column base: **LC** **QC** **CH** **SH**  
 NA +35 +25 +65







Top Size	Base	Model Number	3P	3K	3W	W1-W4	F1-F5	Ganging 60° Wedge (with column*)
20 x 20	Ganging	WG60D20GN	\$ 246	\$ 302	\$ 343	NA	\$ 236	
24 x 24	Ganging	WG60D24GN	254	314	366	NA	236	
30 x 30	Static, GN	44WG60D30GNC2	404	491	543	NA	377	
	Ganging	WG60D30GN	322	410	462	NA	292	
36 x 36	Static, GN	44WG60D36GNC2	468	580	634	NA	527	
	Ganging	WG30D36GN	386	499	553	NA	442	



1 column base: **LC** **QC** **CH** **SH**  
 NA +35 +25 +65





- LC**  
+90
- QC**  
+140
- CH**  
+100
- WM**  
+125
- WMLC**  
+45
- MMLC**  
+55
- SH**  
+260
- FR**  
NA
- PB**  
NA
- GR**  
+40
- CM**  
+50
- RC**  
+55
- GN**  
+40
- LT**  
+115
- AH**  
+500
- NU**  
NA

Video Wedge with column bases	Top Size	Base	Model Number	3P	3K	3W	W1-W4	F1-F5
 	20 x 20 x 40	Static	44VW2040C2	\$ 617	\$ 711	\$ 771	NA	\$ 601
	24 x 24 x 48	Static	44VW2448C2	660	771	844	NA	690
	30 x 30 x 60	Static	44VW3060C2	867	1,034	1,104	NA	926
	36 x 36 x 72	Static	44VW3672C2	1,117	1,383	1,418	NA	1,127

10° Transition with column bases	Top Size	Base	Model Number	3P	3K	3W	W1-W4	F1-F5
 	20 x 30	Static	44TN2030C2	\$ 521	\$ 577	\$ 643	NA	\$ 551
	24 x 30	Static	44TN2430C2	532	592	662	NA	581
	30 x 30	Static	44TN3030C2	588	670	735	NA	627
	36 x 30	Static	44TN3630C2	652	759	817	NA	672

Trident with column bases	Top Size	Base	Model Number	3P	3K	3W	W1-W4	F1-F5
 	36 x 36 x 18	Static	44TR3618C2(6)	\$ 1,025	\$ 1,218	\$ 1,201	\$ 1,557	\$ 910
	40 x 40 x 20	Static	44TR4020C2(6)	1,131	1,365	1,331	1,680	1,175
	48 x 48 x 24	Static	44TR4824C2(6)	1,144	1,384	1,374	1,953	1,175
	60 x 60 x 30	Static	44TR6030C2(6)	1,331	1,646	1,623	2,388	NA

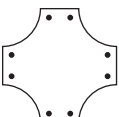

6 bases: **LC** **QC** **SH** **CH** **AH**  
 +135 +210 +390 +150 NA



Quadrant with column bases	Top Size	Base	Model Number	3P	3K	3W	W1-W4	F1-F5
 	60 x 60 x 18	Static	44QD6018C2(8)	\$ 1,537	\$ 1,869	\$ 1,855	\$ 2,708	\$ NA
	60 x 60 x 20	Static	44QD6020C2(8)	1,537	1,869	1,857	2,708	NA
	60 x 60 x 24	Static	44QD6024C2(8)	1,537	1,869	1,861	2,708	NA
	60 x 60 x 30	Static	44QD6030C2(8)	1,537	1,869	1,867	2,708	NA



8 bases: **LC** **QC** **SH** **CH** **AH**  
 +180 +280 +520 +200 NA



Primary



- LC**  
+90
- QC**  
+140
- CH**  
+100
- WM**  
+125
- WMLC**  
+45
- MMLC**  
+55
- SH**  
+260
- FR**  
NA
- PB**  
NA
- GR**  
+40
- CM**  
+50
- RC**  
+55
- GN**  
+40
- LT**  
+115
- AH**  
+500
- NU**  
NA

Top Size	Base	Model Number	3P	3K	3W	W1-W4	F1-F5	Bulb with column bases
24 x 24 x 18	Static	44BU2418C2	\$ 710	\$ 841	\$ 834	\$1,302	\$ 545	 
30 x 30 x 20	Static	44BU3020C2	749	895	900	1,560	627	
36 x 36 x 24	Static	44BU3624C2	854	1,043	1,039	1,825	727	
42 x 42 x 30	Static	44BU4230C2	951	1,179	1,168	2,110	845	
48 x 48 x 36	Static	44BU4836C2	964	1,197	1,205	2,399	982	

Top Size	Base	Model Number	3P	3K	3W	W1-W4	F1-F5	Squircle with column bases	new
24 x 24	Static	44SL24C2	\$ 663	\$ 776	\$ 802	NA	\$ 528	 	
30 x 30	Static	44SL30C2	712	844	883	NA	584		
36 x 36	Static	44SL36C2	766	919	971	NA	733		
42 x 42	Static	44SL42C2	825	1,002	1,063	NA	755		
48 x 48	Static	44SL48C2	896	1,101	1,169	NA	776		

Top Size	Base	Model Number	3P	3K	3W	W1-W4	F1-F5	Squircle with thin squircle disc base	new
24 x 24	Static	99SL24SD16	\$ 757	\$ 869	\$ 895	NA	\$ 626	  <div style="border: 1px solid black; padding: 5px; margin-top: 10px;"> <p>thin disc base: <span>CH NA</span> <span>SH +65</span> <span>NU NA</span></p> </div> <div style="border: 1px solid black; padding: 5px; margin-top: 10px;"> <p><b>BL • BLS</b></p> <p>Counterbalanced &amp; Short Balanced Height Adj.</p> </div>	
	Short Bal	99SL24SD16BLS	1,178	1,290	1,317	NA	1,068		
30 x 30	Static	99SL30SD16	805	937	977	NA	682		
	Short Bal	99SL30SD16BLS	1,226	1,358	1,398	NA	1,124		
36 x 36	Static	99SL36SD20	889	1,042	1,093	NA	862		
	Short Bal	99SL36SD20BLS	1,531	1,685	1,736	NA	1,537		
	Count Bal	99SL36SD20BL	1,531	1,685	1,736	NA	1,537		
42 x 42	Static	99SL42SD26	1,045	1,222	1,283	NA	986		
	Short Bal	99SL42SD26BLS	1,680	1,857	1,918	NA	1,652		
	Count Bal	99SL42SD26BL	1,680	1,857	1,918	NA	1,652		

Top Size	Base	Model Number	3P	3K	3W	W1-W4	F1-F5	Teardrop with column bases
24 x 48	Static	44TE2448C2	\$ 804	\$ 972	\$1,032	NA	693	 

Top Size	Base	Model Number	3P	3K	3W	W1-W4	F1-F5	Table Desk with column bases
37 x 60	Static	44TA3760C2	\$ 913	\$1,099	\$1,206	\$1,897	\$1,032	 
42 x 78	Static	44TA4278C2	1,168	1,455	1,545	2,321	1,364	

- LC +90
- QC +140
- CH +100
- WM +125
- WMLC +45
- MMLC +55
- SH +260
- FR NA
- PB NA
- GR +40
- CM +50
- RC +55
- GN +40
- LT +115
- AH +500
- NU NA



A base that seems to melt into the floor. Puddle is a clean and simple solution. Available on square, round, rectangle, and racetrack tables.

## Puddle Base



D

## Puddle Base Options

- LC** **Locking Casters**  
are not available on Puddle tables.
- FD** **Folding Bases**  
are not available on Puddle tables.
- NE** **Nesting Tables**  
are not available on Puddle tables.
- FT** **Flip Tops**  
are not available on Puddle tables.
- CH** **Chrome Finish**  
available for \$250 per base.
- WM** **Wire Management**  
Built in wire management is available on one leg for \$125.
- WMLC** **Wire Management Leg Covers**  
snap onto any leg and are \$45 each.
- SH** **Special Height**  
of can be added to any table:  
+ \$65 per column for heights > 29"  
+ \$35 per column for heights < 29"  
Special height tables larger than 36x72" must be custom quoted.
- FR** **Footring**  
is not available on Puddle tables.
- PB** **Power Box Mounting Plate**  
is available on disc bases for \$90.

## Puddle Height Adjustable Options

- AH Spring Clip** is available on disc bases for \$125 per base. Not available in chrome.
- BL Counterbalanced & counterbalanced short** are available on single disc bases and are available in three finishes:
  - 02 Black
  - 30 Pearl
  - 37 Satin Silver

## Puddle Top Shapes



square p.136



rectangle p.136



round p.137



squircle p.137

**new**











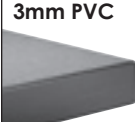
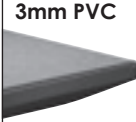

racetrack p.137

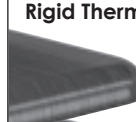
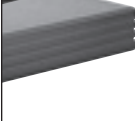
## Puddle Top Options

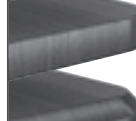

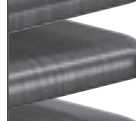
- RC 3" Radius Corners** can be added to any table for \$55.
- GN Ganging Brackets** can be added to most table shapes for \$40.
- LT Lightweight Tops** can be added to any square or rectangular table for \$115. This is a great option when specifying folding tables.
- GR Grommets** can be added to any table for \$40 each. To see specific locations, see page 203.
- CM Cable Manager** can be added to any table for \$50 each. To see specific locations, see page 203.

## Puddle Edge Options

(correspond with 5 columns of pricing)

3mm PVC	3mm PVC	3mm Wood	1.25" Wood	Rigid Thermofoil
 <p><b>3P</b> Flat</p>	 <p><b>3K</b> Knife</p>	 <p><b>3W</b> Flat</p>	 <p><b>W1</b> Bullnose</p>	 <p><b>F1</b> Waterfall</p>
 <p><b>3P</b> Reed</p>			 <p><b>W2</b> Square</p>	 <p><b>F2</b> Flat</p>
			 <p><b>W3</b> Fluted</p>	 <p><b>F3</b> Bevel</p>
			 <p><b>W4</b> Reverse Bevel</p>	 <p><b>F4</b> Radius</p>
				 <p><b>F5</b> Slope</p>

Puddle

Square with disc base	Top Size	Base	Model Number	3P	3K	3W	W1-W4	F1-F5
  Counterbalanced & Short Balanced Height Adj.	24 x 24	Static	45SQ2424D22	\$ 598	\$ 637	\$ 719	\$ 849	\$ 654
		Short Bal	45SQ2424D22BLS	1,232	1,271	1,353	1,483	1,320
	30 x 30	Static	45SQ3030D22	650	709	803	960	710
		Short Bal	45SQ3030D22BLS	1,284	1,343	1,437	1,594	1,376
		Count Bal	45SQ3030D22BL	1,284	1,343	1,437	1,594	1,376
	36 x 36	Static	45SQ3636D26	749	833	936	1,120	898
Short Bal		45SQ3636D26BLS	1,654	1,738	1,841	2,026	1,849	
Count Bal		45SQ3636D26BL	1,654	1,738	1,841	2,026	1,849	



NEW



Rectangular with disc bases	Top Size	Base	Model Number	3P	3K	3W	W1-W4	F1-F5
	24 x 60	Static	45TC2460D22	\$ 1,156	\$ 1,240	\$ 1,371	\$ 1,621	\$ 1,293
	24 x 72	Static	45TC2472D22	1,196	1,295	1,442	1,728	1,326
	24 x 84	Static	45TC2484D22	1,273	1,403	1,555	1,840	1,491
	24 x 90	Static	45TC2490D22	1,387	1,535	1,687	1,962	1,573
	24 x 96	Static	45TC2496D22	1,387	1,535	1,701	2,016	1,583
	30 x 60	Static	45TC3060D22	1,198	1,298	1,430	1,705	1,426
	30 x 72	Static	45TC3072D22	1,242	1,360	1,507	1,825	1,501
	30 x 84	Static	45TC3084D22	1,350	1,512	1,654	1,944	1,512
	30 x 90	Static	45TC3090D22	1,476	1,660	1,799	2,074	1,605
	30 x 96	Static	45TC3096D22	1,476	1,660	1,812	2,131	1,615
	36 x 72	Static	45TC3672D26	1,409	1,564	1,697	1,994	1,720
	36 x 84	Static	45TC3684D26	1,502	1,694	1,827	2,125	1,741
	36 x 90	Static	45TC3690D26	1,637	1,856	1,982	2,258	1,824
	36 x 96	Static	45TC3696D26	1,637	1,856	1,996	2,324	1,829
	42 x 72	Static	45TC4272D26	1,506	1,700	1,817	2,086	1,720
	42 x 84	Static	45TC4284D26	1,583	1,808	1,930	2,229	1,741
	42 x 90	Static	45TC4290D26	1,726	1,982	2,095	2,366	1,834
	42 x 96	Static	45TC4296D26	1,726	1,982	2,109	2,439	1,845

NEW

Rectangular with 3 disc bases	Top Size	Base	Model Number	3P	3K	3W	W1-W4	F1-F5
	42 x 120	Static	45TC42120D26(3)	\$ 2,517	\$ 2,896	\$ 2,986	\$ 3,202	\$ 3,015
	42 x 144	Static	45TC42144D26(3)	2,672	3,113	3,212	3,482	3,036

- LC**  
NA
- CH**  
+250/  
base
- WM**  
+125
- WMLC**  
+45
- SH**  
+65/  
base
- FR**  
NA
- PB**  
+90
- GR**  
+40
- CM**  
+50
- RC**  
+55
- GN**  
+40
- LT**  
+115
- AH**  
+125/  
base

Top Size	Base	Model Number	3P	3K	3W	W1-W4	F1-F5	Round with disc base
24 x 24	Static	45RD24D22	\$ 630	\$ 681	\$ 730	\$ 1,057	\$ 654	   <p>Counterbalanced &amp; Short Balanced Height Adj.</p>
	Short Bal	45RD24D22BLS	1,264	1,315	1,364	1,691	1,320	
30 x 30	Static	45RD30D22	700	779	828	1,237	710	
	Short Bal	45RD30D22BLS	1,334	1,413	1,462	1,871	1,376	
36 x 36	Static	45RD36D22	774	882	931	1,438	859	
	Short Bal	45RD36D22BLS	1,408	1,516	1,565	2,072	1,525	
	Count Bal	45RD36D22BL	1,408	1,516	1,565	2,072	1,525	
42 x 42	Static	45RD42D26	908	1,055	1,097	1,694	919	
	Short Bal	45RD42D26BLS	1,813	1,961	2,002	2,599	1,870	
	Count Bal	45RD42D26BL	1,813	1,961	2,002	2,599	1,870	

Top Size	Base	Model Number	3P	3K	3W	W1-W4	F1-F5	Squire with disc base
24 x 24	Static	45SL24D22	\$ 783	\$ 896	\$ 922	\$ 502	\$ 654	   <p>Counterbalanced &amp; Short Balanced Height Adj.</p>
	Short Bal	45SL24D22BLS	1,417	1,530	1,556	1,136	1,320	
30 x 30	Static	45SL30D22	832	964	1,003	502	710	
	Short Bal	45SL30D22BLS	1,466	1,598	1,637	1,136	1,376	
	Count Bal	45SL30D22BL	1,466	1,598	1,637	1,136	1,376	
36 x 36	Static	45SL36D26	923	1,076	1,127	539	898	
	Short Bal	45SL36D26BLS	1,828	1,981	2,033	1,444	1,849	
	Count Bal	45SL36D26BL	1,828	1,981	2,033	1,444	1,849	

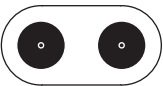
Top Size	Base	Model Number	3P	3K	3W	W1-W4	F1-F5	Racetrack with disc base
36 x 72	Static	45RT3672D26	\$ 1,584	\$ 1,810	\$ 1,854	\$ 2,506	\$ 1,851	 
36 x 84	Static	45RT3684D26	1,679	1,942	1,986	2,691	1,876	
36 x 90	Static	45RT3690D26	1,869	2,181	2,202	2,851	1,960	
36 x 96	Static	45RT3696D26	1,869	2,181	2,216	2,939	1,967	
42 x 84	Static	45RT4284D26	1,782	2,086	2,107	2,829	1,876	
42 x 90	Static	45RT4290D26	1,961	2,309	2,311	2,997	1,973	
42 x 96	Static	45RT4296D26	1,961	2,309	2,325	3,093	1,986	

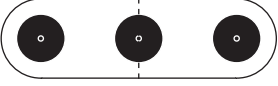
Top Size	Base	Model Number	3P	3K	3W	W1-W4	F1-F5	Racetrack with 3 disc base
42 x 120	Static	45RT42120D26(3)	\$ 2,951	\$ 3,503	\$ 3,421	\$ 3,960	3,015	 
42 x 144	Static	45RT42144D26(3)	3,195	3,845	3,745	4,348	3,036	

- LC**  
NA
- CH**  
+250/  
base
- WM**  
+125
- WM/LC**  
+45
- SH**  
+65/  
base
- FR**  
NA
- PB**  
+90
- GR**  
+40
- CM**  
+50
- RC**  
NA
- GN**  
NA
- LT**  
+115
- AH**  
+125/  
base



Exclaim

**new**



Exclaim is both simple, yet sophisticated. These angled square columns build a collection of attractive tables with a variety of base configurations.

## Exclaim Base Configurations

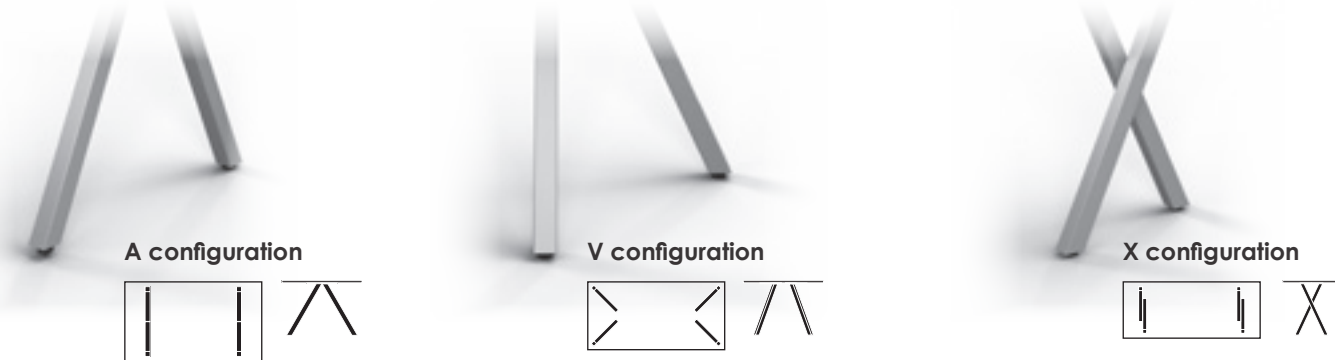

A configuration

V configuration

X configuration

## Exclaim Base Options

angled 2" column with standard glides

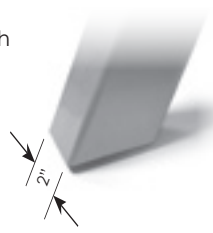

angled 3" column with standard glides

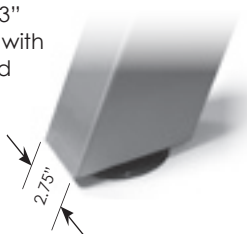

- LC** **Locking Casters** are not available on Exclaim tables.
- FD** **Folding Bases** are not available on Exclaim tables.
- NE** **Nesting Tables** are not available on Exclaim tables.
- FT** **Flip Tops** are not available on Exclaim tables.

**CH** **Chrome Finish** available for \$80 per column on tables using a 3" angled column. Not available on 2" columns.

**WM** **Wire Management Holes** Two wire management mouse holes available for \$30 per leg on the 3" columns only. Not available on chrome.

**MMLC** **Magnet Wire Management Leg Covers** Magnetically snap onto any square leg and are \$55 each.

**SH** **Special Heights:**  
 - of 18" is available on select Exclaim models. These models are shown on pages 149.1-149.2.  
 - of 42" is available on all standard Exclaim tables for \$50 list per column.  
 - other custom heights are not available on Exclaim.

**PB** **Power Box Mounting Plate** is not available on Exclaim tables.

online updates  
 new product  
 clarification / edit  
 deletion



### Exclaim Top Shapes



rectangle  
p.140-141



boat  
p.142



racetrack  
p.143



elliptical  
p.144-145



D-shaped  
p.146-147



square  
p.148



round  
p.148



quadrant  
p.149



trident  
p.149



table desk  
p.149

Exclaim

online updates

new product

clarification / edit

deletion

### Exclaim Lounge Height Top Shapes



square  
p.149.1



round  
p.149.1



rectangle  
p.149.2

### Exclaim Top Options

**RC 3" Radius Corners**  
can be added to any table for \$55.

**GN Ganging Brackets**  
can be added to most table shapes for \$40.

**LT Lightweight Tops**  
can be added to any square or rectangular table for \$115.

**GR Grommets**  
can be added to any table for \$40 each. To see specific locations, see page 203.



**CM Cable Manager**  
can be added to any table for \$50 each. To see specific locations, see page 203.

### Exclaim Edge Options

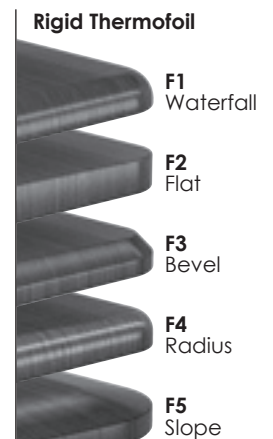
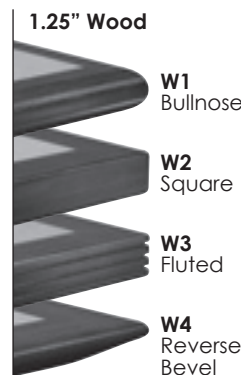
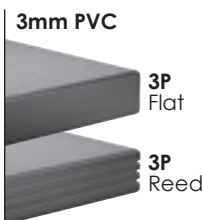

(correspond with 5 columns of pricing)



NEW

Rectangular with X configuration	Top Size	Base	Model Number	3P	3K	3W	W1-W4	F1-F5
 	20 x 36	Angled 2"	71TC2036Q2.X	\$ 717	\$ 774	\$ 861	\$ 987	\$ 760
	20 x 48	Angled 2"	71TC2048Q2.X	763	838	939	1,091	777
	20 x 60	Angled 2"	71TC2060Q2.X	784	868	990	1,191	865
	20 x 72	Angled 2"	71TC2072Q2.X	892	991	1,129	1,363	974
	20 x 84	Angled 2"	71TC2084Q2.X	969	1,099	1,241	1,467	1,096
	20 x 90	Angled 2"	71TC2090Q2.X	1,015	1,163	1,306	1,517	1,096
	20 x 96	Angled 2"	71TC2096Q2.X	1,015	1,163	1,320	1,567	1,117
	24 x 36	Angled 2"	71TC2436Q2.X	717	774	870	1,029	821
	24 x 48	Angled 2"	71TC2448Q2.X	763	838	948	1,137	838
	24 x 60	Angled 2"	71TC2460Q2.X	784	868	999	1,249	903
	24 x 72	Angled 2"	71TC2472Q2.X	824	923	1,070	1,356	936
	24 x 84	Angled 2"	71TC2484Q2.X	969	1,099	1,251	1,536	1,172
	24 x 90	Angled 2"	71TC2490Q2.X	1,015	1,163	1,315	1,590	1,182
	24 x 96	Angled 2"	71TC2496Q2.X	1,015	1,163	1,329	1,644	1,193
	30 x 36	Angled 2"	71TC3036Q2.X	751	821	921	1,091	865
	30 x 48	Angled 2"	71TC3048Q2.X	808	901	1,011	1,214	875
	30 x 60	Angled 2"	71TC3060Q2.X	826	926	1,058	1,333	1,035
	30 x 72	Angled 2"	71TC3072Q2.X	870	988	1,135	1,453	1,111
	30 x 84	Angled 2"	71TC3084Q2.X	1,047	1,208	1,350	1,640	1,193
	30 x 90	Angled 2"	71TC3090Q2.X	1,104	1,288	1,427	1,702	1,214
30 x 96	Angled 2"	71TC3096Q2.X	1,104	1,288	1,440	1,759	1,225	

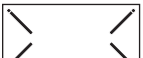
NEW

Rectangular with V configuration	Top Size	Base	Model Number	3P	3K	3W	W1-W4	F1-F5
 	36 x 48	Angled 2"	71TC3648Q2.V	\$ 853	\$ 964	\$ 1,074	\$ 1,287	\$ 925
	36 x 60	Angled 2"	71TC3660Q2.V	921	1,059	1,177	1,418	1,132
	36 x 72	Angled 2"	71TC3672Q2.V	963	1,119	1,252	1,549	1,253
	36 x 84	Angled 2"	71TC3684Q2.V	1,124	1,317	1,450	1,748	1,345
	36 x 90	Angled 2"	71TC3690Q2.V	1,191	1,411	1,537	1,813	1,356
	36 x 96	Angled 2"	71TC3696Q2.V	1,191	1,411	1,551	1,879	1,361
	42 x 60	Angled 3"	71TC4260Q3.V	991	1,153	1,267	1,510	1,133
	42 x 72	Angled 3"	71TC4272Q3.V	1,072	1,266	1,384	1,652	1,265
	42 x 84	Angled 3"	71TC4284Q3.V	1,217	1,442	1,565	1,863	1,357
	42 x 90	Angled 3"	71TC4290Q3.V	1,293	1,548	1,661	1,932	1,379
	42 x 96	Angled 3"	71TC4296Q3.V	1,293	1,548	1,675	2,005	1,389
	48 x 60	Angled 3"	71TC4860Q3.V	1,049	1,234	1,344	1,595	1,245
	48 x 72	Angled 3"	71TC4872Q3.V	1,141	1,363	1,474	1,749	1,376
	48 x 84	Angled 3"	71TC4884Q3.V	1,217	1,442	1,578	1,967	1,469
	48 x 90	Angled 3"	71TC4890Q3.V	1,294	1,549	1,676	2,044	1,511
	48 x 96	Angled 3"	71TC4896Q3.V	1,294	1,549	1,690	2,121	1,522



online updates

new product

clarification / edit

deletion

LC  
NA

CCG  
NA

CH  
Q3  
+320

WM  
Q3  
+30

MMLC  
+55

SH  
+50/C

PB  
NA

GR  
+40

CM  
+50

RC  
+55

GN  
+40

LT  
+115

Top Size	Base	Model Number	3P	3K	3W	W1-W4	F1-F5	Rectangular with V6 configuration	<b>new</b>
42 x 120	Angled 3"	71TC42120Q3.V6	\$ 1,935	\$ 2,313	\$ 2,403	\$ 2,619	\$ 2,403		
42 x 144	Angled 3"	71TC42144Q3.V6	2,090	2,531	2,629	2,900	2,424		
48 x 120	Angled 3"	71TC48120Q3.V6	1,944	2,327	2,428	2,757	2,456		
48 x 144	Angled 3"	71TC48144Q3.V6	2,101	2,546	2,656	3,057	2,509		

6 bases: **CH**  
+480

Exclaim



online updates

new product

clarification / edit

deletion

Top Size	Base	Model Number	3P	3K	3W	W1-W4	F1-F5	Rectangular with A configuration	<b>new</b>
42 x 60	Angled 3"	71TC4260Q3.A	\$ 991	\$ 1,153	\$ 1,267	\$ 1,510	\$ 1,133		
42 x 72	Angled 3"	71TC4272Q3.A	1,072	1,266	1,384	1,652	1,265		
42 x 84	Angled 3"	71TC4284Q3.A	1,217	1,442	1,565	1,863	1,357		
42 x 90	Angled 3"	71TC4290Q3.A	1,293	1,548	1,661	1,932	1,379		
42 x 96	Angled 3"	71TC4296Q3.A	1,293	1,548	1,675	2,005	1,389		
48 x 60	Angled 3"	71TC4860Q3.A	1,049	1,234	1,344	1,595	1,245		
48 x 72	Angled 3"	71TC4872Q3.A	1,141	1,363	1,474	1,749	1,376		
48 x 84	Angled 3"	71TC4884Q3.A	1,217	1,442	1,578	1,967	1,469		
48 x 90	Angled 3"	71TC4890Q3.A	1,294	1,549	1,676	2,044	1,511		
48 x 96	Angled 3"	71TC4896Q3.A	1,294	1,549	1,690	2,121	1,522		

Top Size	Base	Model Number	3P	3K	3W	W1-W4	F1-F5	Rectangular with A6 configuration	<b>new</b>
42 x 120	Angled 3"	71TC42120Q3.A6	\$ 1,935	\$ 2,313	\$ 2,403	\$ 2,619	\$ 2,403		
42 x 144	Angled 3"	71TC42144Q3.A6	2,090	2,531	2,629	2,900	2,424		
48 x 120	Angled 3"	71TC48120Q3.A6	1,944	2,327	2,428	2,757	2,456		
48 x 144	Angled 3"	71TC48144Q3.A6	2,101	2,546	2,656	3,057	2,509		

6 bases: **CH**  
+480

**LC**  
NA

**CCG**  
NA

**CH**  
Q3  
+320

**WM**  
Q3  
+30

**MMLC**  
+55

**SH**  
+50/C

**PB**  
NA

**GR**  
+40



**CM**  
+50

**RC**  
+55

**GN**  
+40

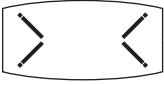

**LT**  
+115

NEW

Boat-Shaped with V configuration	Top Size	Base	Model Number	3P	3K	3W	W1-W4	F1-F5
 	30 x 42 x 84	Angled 3"	71BT3084Q3.V	\$ 1,418	\$ 1,724	\$ 1,744	\$2,463	\$ 1,492
	30 x 42 x 90	Angled 3"	71BT3090Q3.V	1,527	1,875	1,877	2,563	1,517
	30 x 42 x 96	Angled 3"	71BT3096Q3.V	1,527	1,875	1,891	2,660	1,530
	36 x 48 x 84	Angled 3"	71BT3684Q3.V	1,526	1,874	1,870	2,606	1,505
	36 x 48 x 90	Angled 3"	71BT3690Q3.V	1,649	2,047	2,019	2,710	1,557
	36 x 48 x 96	Angled 3"	71BT3696Q3.V	1,649	2,047	2,033	2,810	1,569

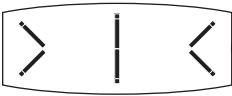

Exclaim

NEW



Boat-Shaped with V6 configuration	Top Size	Base	Model Number	3P	3K	3W	W1-W4	F1-F5
 	36 x 48 x 120	Angled 3"	71BT36120Q3.V6	\$2,382	\$2,939	\$2,861	\$3,550	\$2,456
	36 x 48 x 144	Angled 3"	71BT36144Q3.V6	2,628	3,284	3,188	3,962	2,509

6 bases: **CH**  
+480

NEW

Boat-Shaped with A configuration	Top Size	Base	Model Number	3P	3K	3W	W1-W4	F1-F5
 	36 x 48 x 84	Angled 3"	71BT3684Q3.A	\$ 1,526	\$ 1,874	\$ 1,870	\$2,606	\$ 1,505
	36 x 48 x 90	Angled 3"	71BT3690Q3.A	1,649	2,047	2,019	2,710	1,557
	36 x 48 x 96	Angled 3"	71BT3696Q3.A	1,649	2,047	2,033	2,810	1,569

NEW

Boat-Shaped with A6 configuration	Top Size	Base	Model Number	3P	3K	3W	W1-W4	F1-F5
 	36 x 48 x 120	Angled 3"	71BT36120Q3.A6	\$2,382	\$2,939	\$2,861	\$3,550	\$2,456
	36 x 48 x 144	Angled 3"	71BT36144Q3.A6	2,628	3,284	3,188	3,962	2,509

6 bases: **CH**  
+480

online updates  
new product  
clarification / edit  
deletion

- LC**  
NA
- CCG**  
NA
- CH**  
Q3  
+320
- WM**  
Q3  
+30
- MMLC**  
+55
- SH**  
+50/C
- PB**  
NA
- GR**  
+40
- CM**  
+50
- RC**  
+55
- GN**  
+40
- LT**  
+115

Top Size	Base	Model Number	3P	3K	3W	W1-W4	F1-F5	Racetrack with V configuration
36 x 60	Angled 2"	71RT3660Q2.V	\$1,048	\$1,238	\$1,282	\$1,880	\$1,238	 
36 x 72	Angled 2"	71RT3672Q2.V	1,139	1,365	1,409	2,061	1,383	
36 x 84	Angled 2"	71RT3684Q2.V	1,302	1,565	1,609	2,313	1,480	
36 x 90	Angled 2"	71RT3690Q2.V	1,424	1,736	1,757	2,406	1,493	
36 x 96	Angled 2"	71RT3696Q2.V	1,424	1,736	1,771	2,494	1,499	
42 x 84	Angled 3"	71RT4284Q3.V	1,416	1,720	1,741	2,463	1,492	
42 x 90	Angled 3"	71RT4290Q3.V	1,527	1,875	1,877	2,563	1,517	
42 x 96	Angled 3"	71RT4296Q3.V	1,527	1,875	1,891	2,660	1,530	
48 x 84	Angled 3"	71RT4884Q3.V	1,649	2,047	2,006	2,606	1,505	
48 x 90	Angled 3"	71RT4890Q3.V	1,649	2,047	2,019	2,710	1,555	
48 x 96	Angled 3"	71RT4896Q3.V	1,649	2,047	2,033	2,810	1,568	

**new**

Exclaim

Top Size	Base	Model Number	3P	3K	3W	W1-W4	F1-F5	Racetrack with V6 configuration
42 x 120	Angled 3"	71RT42120Q3.V6	\$1,935	\$2,313	\$2,403	\$2,619	\$2,403	 
42 x 144	Angled 3"	71RT42144Q3.V6	2,090	2,531	2,629	2,900	2,424	
48 x 120	Angled 3"	71RT48120Q3.V6	1,944	2,327	2,428	2,757	2,456	
48 x 144	Angled 3"	71RT48144Q3.V6	2,101	2,546	2,656	3,057	2,509	

6 bases: **CH** +480

Top Size	Base	Model Number	3P	3K	3W	W1-W4	F1-F5	Racetrack with A configuration
42 x 84	Angled 3"	71RT4284Q3.A	\$1,416	\$1,720	\$1,741	\$2,463	\$1,492	 
42 x 90	Angled 3"	71RT4290Q3.A	1,527	1,875	1,877	2,563	1,517	
42 x 96	Angled 3"	71RT4296Q3.A	1,527	1,875	1,891	2,660	1,530	
48 x 84	Angled 3"	71RT4884Q3.A	1,649	2,047	2,006	2,606	1,505	
48 x 90	Angled 3"	71RT4890Q3.A	1,649	2,047	2,019	2,710	1,555	
48 x 96	Angled 3"	71RT4896Q3.A	1,649	2,047	2,033	2,810	1,568	

Top Size	Base	Model Number	3P	3K	3W	W1-W4	F1-F5	Racetrack with A6 configuration
42 x 120	Angled 3"	71RT42120Q3.A6	\$2,368	\$2,920	\$2,839	\$3,377	\$2,403	 
42 x 144	Angled 3"	71RT42144Q3.A6	2,612	3,262	3,162	3,765	2,424	
48 x 120	Angled 3"	71RT48120Q3.A6	2,382	2,940	2,862	3,550	2,456	
48 x 144	Angled 3"	71RT48144Q3.A6	2,629	3,285	3,188	3,962	2,509	

6 bases: **CH** +480

online updates



new product

clarification / edit

deletion



- LC**  
NA
- CCG**  
NA
- CH**  
Q3  
+320
- WM**  
Q3  
+30
- MMLC**  
+55
- SH**  
+50/C
- PB**  
NA
- GR**  
+40
- CM**  
+50
- RC**  
+55
- GN**  
+40
- LT**  
+115

NEW



Elliptical with X configuration	Top Size	Base	Model Number	3P	3K	3W	W1-W4	F1-F5
	30 x 54	Angled 2"	71EL3054Q2.X	\$ 931	\$ 1,074	\$ 1,119	\$ 1,676	\$ 1,011
	30 x 60	Angled 2"	71EL3060Q2.X	969	1,126	1,171	1,760	1,035
	36 x 60	Angled 2"	71EL3660Q2.X	1,048	1,238	1,270	1,880	1,132
	36 x 72	Angled 2"	71EL3672Q2.X	1,139	1,365	1,391	2,061	1,253
	36 x 84	Angled 2"	71EL3684Q2.X	1,302	1,565	1,585	2,313	1,345
	36 x 90	Angled 2"	71EL3690Q2.X	1,424	1,736	1,730	2,406	1,392
	36 x 96	Angled 2"	71EL3696Q2.X	1,424	1,736	1,741	2,494	1,417

Exclaim

NEW

Elliptical with V configuration	Top Size	Base	Model Number	3P	3K	3W	W1-W4	F1-F5
	42 x 72	Angled 3"	71EL4272Q3.V	\$ 1,245	\$ 1,509	\$ 1,518	\$ 2,203	\$ 1,265
	42 x 84	Angled 3"	71EL4284Q3.V	1,416	1,720	1,721	2,463	1,357
	42 x 90	Angled 3"	71EL4290Q3.V	1,529	1,878	1,855	2,563	1,379
	42 x 96	Angled 3"	71EL4296Q3.V	1,529	1,878	1,866	2,660	1,389
	48 x 72	Angled 3"	71EL4872Q3.V	1,367	1,679	1,663	2,334	1,376
	48 x 84	Angled 3"	71EL4884Q3.V	1,447	1,764	1,766	2,606	1,469
	48 x 90	Angled 3"	71EL4890Q3.V	1,649	2,047	1,999	2,710	1,511
	48 x 96	Angled 3"	71EL4896Q3.V	1,649	2,047	2,010	2,810	1,522

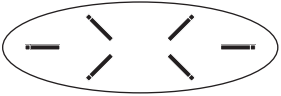
NEW

Elliptical with V6 configuration	Top Size	Base	Model Number	3P	3K	3W	W1-W4	F1-F5
	42 x 120	Angled 3"	71EL42120Q3.V6	\$ 2,368	\$ 2,920	\$ 2,800	\$ 3,377	2,403
	42 x 144	Angled 3"	71EL42144Q3.V6	2,612	3,262	3,112	3,765	2,424
	48 x 120	Angled 3"	71EL48120Q3.V6	2,382	2,940	2,826	3,550	2,456
	48 x 144	Angled 3"	71EL48144Q3.V6	2,629	3,285	3,141	3,962	2,509

6 bases: **CH**  
+480

online updates  
new product  
clarification / edit  
deletion

- LC**  
NA
- CCG**  
NA
- CH**  
Q3  
+320
- WM**  
Q3  
+30
- MMLC**  
+55
- SH**  
+50/C
- PB**  
NA
- GR**  
+40
- CM**  
+50
- RC**  
+55
- GN**  
+40
- LT**  
+115

Top Size	Base	Model Number	3P	3K	3W	W1-W4	F1-F5	Elliptical with A configuration
42 x 72	Angled 3"	71EL4272Q3.A	\$ 1,245	\$ 1,509	\$ 1,518	\$ 2,203	\$ 1,265	
42 x 84	Angled 3"	71EL4284Q3.A	1,416	1,720	1,721	2,463	1,357	
42 x 90	Angled 3"	71EL4290Q3.A	1,529	1,878	1,855	2,563	1,379	
42 x 96	Angled 3"	71EL4296Q3.A	1,529	1,878	1,866	2,660	1,389	
48 x 72	Angled 3"	71EL4872Q3.A	1,367	1,679	1,663	2,334	1,376	
48 x 84	Angled 3"	71EL4884Q3.A	1,447	1,764	1,766	2,606	1,469	
48 x 90	Angled 3"	71EL4890Q3.A	1,649	2,047	1,999	2,710	1,511	
48 x 96	Angled 3"	71EL4896Q3.A	1,649	2,047	2,010	2,810	1,522	

new

Exclaim



online updates  
new product  
clarification / edit  
deletion

Top Size	Base	Model Number	3P	3K	3W	W1-W4	F1-F5	Elliptical with A6 configuration
42 x 120	Angled 3"	71EL42120Q3.A6	\$ 2,368	\$ 2,920	\$ 2,800	\$ 3,377	\$ 2,403	
42 x 144	Angled 3"	71EL42144Q3.A6	2,612	3,262	3,112	3,765	2,424	
48 x 120	Angled 3"	71EL48120Q3.A6	2,382	2,940	2,826	3,550	2,456	
48 x 144	Angled 3"	71EL48144Q3.A6	2,629	3,285	3,141	3,962	2,509	

new

6 bases: **CH**  
+480

new

D-shaped with X configuration	Top Size	Base	Model Number	3P	3K	3W	W1-W4	F1-F5
 	24 x 36	Angled 2"	71D2436Q2.X	\$ 763	\$ 838	\$ 908	\$ 1,199	\$ 820
	24 x 48	Angled 2"	71D2448Q2.X	825	925	1,005	1,333	893
	24 x 60	Angled 2"	71D2460Q2.X	888	1,013	1,101	1,468	966
	24 x 72	Angled 2"	71D2472Q2.X	950	1,100	1,197	1,603	1,039
	24 x 84	Angled 2"	71D2484Q2.X	1,081	1,256	1,362	1,805	1,183
	24 x 90	Angled 2"	71D2490Q2.X	1,112	1,299	1,410	1,875	1,220
	24 x 96	Angled 2"	71D2496Q2.X	1,143	1,343	1,458	1,944	1,256
	30 x 48	Angled 2"	71D3048Q2.X	888	1,013	1,084	1,429	966
	30 x 60	Angled 2"	71D3060Q2.X	966	1,122	1,198	1,576	1,035
	30 x 72	Angled 2"	71D3072Q2.X	1,044	1,231	1,311	1,722	1,148
	30 x 84	Angled 2"	71D3084Q2.X	1,190	1,409	1,493	1,936	1,311
	30 x 90	Angled 2"	71D3090Q2.X	1,229	1,464	1,550	2,009	1,356
	30 x 96	Angled 2"	71D3096Q2.X	1,268	1,518	1,607	2,082	1,402

Exclaim





online updates

new product

clarification / edit

deletion

new

D-shaped with V configuration	Top Size	Base	Model Number	3P	3K	3W	W1-W4	F1-F5
 	36 x 48	Angled 2"	71D3648Q2.V	\$ 950	\$ 1,100	\$ 1,164	\$ 1,526	\$ 1,039
	36 x 60	Angled 2"	71D3660Q2.V	1,044	1,231	1,295	1,683	1,148
	36 x 72	Angled 2"	71D3672Q2.V	1,138	1,363	1,425	1,837	1,253
	36 x 84	Angled 2"	71D3684Q2.V	1,299	1,562	1,624	2,063	1,345
	36 x 90	Angled 2"	71D3690Q2.V	1,346	1,628	1,690	2,144	1,499
	36 x 96	Angled 2"	71D3696Q2.V	1,393	1,693	1,755	2,221	1,510
	42 x 60	Angled 3"	71D4260Q3.V	1,133	1,352	1,403	1,799	1,251
	42 x 72	Angled 3"	71D4272Q3.V	1,243	1,505	1,551	1,968	1,265
	42 x 84	Angled 3"	71D4284Q3.V	1,521	1,867	1,877	2,202	1,357
	42 x 90	Angled 3"	71D4290Q3.V	1,583	1,954	1,960	2,286	1,379
	42 x 96	Angled 3"	71D4296Q3.V	1,645	2,041	2,041	2,371	1,522
	48 x 60	Angled 3"	71D4860Q3.V	1,212	1,461	1,500	1,906	1,342
	48 x 72	Angled 3"	71D4872Q3.V	1,336	1,636	1,665	2,083	1,376
	48 x 84	Angled 3"	71D4884Q3.V	1,530	1,880	1,898	2,332	1,469
	48 x 90	Angled 3"	71D4890Q3.V	1,592	1,967	1,981	2,509	1,511
	48 x 96	Angled 3"	71D4896Q3.V	1,655	2,055	2,063	2,509	1,522
	54 x 54	Angled 3"	71D5454Q3.V	1,360	1,669	1,660	1,922	NA
	60 x 60	Angled 3"	71D6060Q3.V	1,368	1,680	1,693	2,122	NA

LC  
NA

CCG  
NA

CH  
Q3  
+320

WM  
Q3  
+30

MMLC  
+55

SH  
+50/C

PB  
NA

GR  
+40

CM  
+50

RC  
+55

GN  
+40

LT  
+115



Top Size	Base	Model Number	3P	3K	3W	W1-W4	F1-F5	D-shaped with A configuration
42 x 60	Angled 3"	71D4260Q3.A	\$ 1,133	\$ 1,352	\$ 1,403	\$ 1,799	\$ 1,251	
42 x 72	Angled 3"	71D4272Q3.A	1,243	1,505	1,551	1,968	1,265	
42 x 84	Angled 3"	71D4284Q3.A	1,521	1,867	1,877	2,202	1,357	
42 x 90	Angled 3"	71D4290Q3.A	1,583	1,954	1,960	2,286	1,379	
42 x 96	Angled 3"	71D4296Q3.A	1,645	2,041	2,041	2,371	1,522	
48 x 60	Angled 3"	71D4860Q3.A	1,212	1,461	1,500	1,906	1,342	
48 x 72	Angled 3"	71D4872Q3.A	1,336	1,636	1,665	2,083	1,376	
48 x 84	Angled 3"	71D4884Q3.A	1,530	1,880	1,898	2,332	1,469	
48 x 90	Angled 3"	71D4890Q3.A	1,592	1,967	1,981	2,509	1,511	
48 x 96	Angled 3"	71D4896Q3.A	1,655	2,055	2,063	2,509	1,522	
54 x 54	Angled 3"	71D5454Q3.A	1,360	1,669	1,660	1,922	NA	
60 x 60	Angled 3"	71D6060Q3.A	1,368	1,680	1,693	2,122	NA	

**new**

Exclaim



online updates

new product

clarification / edit

deletion

LC  
NA

CCG  
NA

CH  
Q3  
+320

WM  
Q3  
+30

MMLC  
+55

SH  
+50/C

PB  
NA

GR  
+40



CM  
+50

RC  
+55



GN  
+40

LT  
+115

new



Square with 4 columns	Top Size	Base	Model Number	3P	3K	3W	W1-W4	F1-F5
 	36 x 36	Angled 2"	71SQ3636Q2	\$ 785	\$ 869	\$ 972	\$ 1,156	936
	42 x 42	Angled 2"	71SQ4242Q2	858	971	1,081	1,291	957
		Angled 3"	71SQ4242Q3	870	983	1,092	1,302	969
	48 x 48	Angled 2"	71SQ4848Q2	943	1,090	1,201	1,433	978
		Angled 3"	71SQ4848Q3	954	1,101	1,212	1,445	990
	54 x 54	Angled 3"	71SQ5454Q3	1,049	1,234	1,345	1,599	NA
60 x 60	Angled 3"	71SQ6060Q3	1,156	1,383	1,489	1,764	NA	

new

Round with 3 columns	Top Size	Base	Model Number	3P	3K	3W	W1-W4	F1-F5
 	42 x 42	Angled 2"	71RD42Q2(3)	\$ 815	\$ 962	\$ 1,004	\$ 1,600	821
	48 x 48	Angled 3"	71RD48Q3(3)	851	1,009	1,064	1,847	851

3 bases: **CH** +240

new

Round with 4 columns	Top Size	Base	Model Number	3P	3K	3W	W1-W4	F1-F5
 	48 x 48	Angled 2"	71RD48Q2	\$ 971	\$ 1,130	\$ 1,185	\$ 1,968	978
	54 x 54	Angled 3"	71RD54Q3	1,142	1,364	1,394	2,241	NA
	60 x 60	Angled 3"	71RD60Q3	1,164	1,395	1,440	2,518	NA



online updates



new product

clarification / edit

deletion

- LC**  
NA
- CCG**  
NA
- CH**  
Q3  
+320
- WM**  
Q3  
+30
- MMLC**  
+55
- SH**  
+50/C
- PB**  
NA
- GR**  
+40
- CM**  
+50
- RC**  
+55
- GN**  
+40
- LT**  
+115



Exclaim

Top Size	Base	Model Number	3P	3K	3W	W1-W4	F1-F5	Trident with 3 columns
48 x 48 x 24	Angled 2"	71TR4824Q2	\$ 1,045	\$ 1,285	\$ 1,275	\$ 1,854	\$ 1,071	 
60 x 60 x 30	Angled 3"	71TR6030Q3	1,241	1,556	1,532	2,298	NA	



3 bases: **CH**  
+240

**new**



Exclaim

Top Size	Base	Model Number	3P	3K	3W	W1-W4	F1-F5	Quadrant with 4 columns
60 x 60 x 18	Angled 3"	71QD6018Q3	\$ 1,416	\$ 1,748	\$ 1,735	\$ 2,588	\$ NA	 
60 x 60 x 20	Angled 3"	71QD6020Q3	1,416	1,748	1,737	2,588	NA	
60 x 60 x 24	Angled 3"	71QD6024Q3	1,416	1,748	1,741	2,588	NA	
60 x 60 x 30	Angled 3"	71QD6030Q3	1,416	1,748	1,747	2,588	NA	

**new**

Top Size	Base	Model Number	3P	3K	3W	W1-W4	F1-F5	Table Desk with V configuration
37 x 60	Angled 2"	71TA3760Q2.V	\$ 1,038	\$ 1,223	\$ 1,331	\$ 2,022	\$ 1,163	 
42 x 78	Angled 3"	71TA4278Q3.V	1,372	1,659	1,749	2,525	1,578	

**new**

Top Size	Base	Model Number	3P	3K	3W	W1-W4	F1-F5	Table Desk with A configuration
42 x 78	Angled 3"	71TA4278Q3.A	\$ 1,372	\$ 1,659	\$ 1,749	\$ 2,525	\$ 1,578	 

**new**

online updates  
new product  
clarification / edit  
deletion

- LC**  
NA
- CCG**  
NA
- CH**  
Q3  
+320
- WM**  
Q3  
+30
- MMLC**  
+55
- SH**  
+50/C
- PB**  
NA
- GR**  
+40
- CM**  
+50
- RC**  
+55
- GN**  
+40
- LT**  
+115

## 3 heights available

**Lounge Height of 18"** is available on square, round, and rectangular tables. These models are designated with a "-SH.18" in the model number and are listed on the next two pages.

**Standard Height of 29"** is shown on all standard models in the Exclaim line. Custom heights outside of the three shown here are not available.

**Standing Height of 42"** is available on any standard Exclaim table. Simply add "-SH.42" to the model number and add \$50 per column to the list price.

Exclaim



## SH.18 special height of 18"

**NEW** 18"H Square with 4 columns

Top Size	Base	Model Number	3P	3K	3W	W1-W4	F1-F5
24 x 24	Angled 2"	71SQ2424Q2-SH.18	\$ 671	\$ 709	\$ 792	\$ 922	\$ 731
30 x 30	Angled 2"	71SQ3030Q2-SH.18	723	781	876	1,033	786
36 x 36	Angled 2"	71SQ3636Q2-SH.18	785	869	972	1,156	936
42 x 42	Angled 2"	71SQ4242Q2-SH.18	858	971	1,081	1,291	957
48 x 48	Angled 2"	71SQ4848Q2-SH.18	943	1,090	1,201	1,433	978

**NEW** 18"H Round with 3 columns

Top Size	Base	Model Number	3P	3K	3W	W1-W4	F1-F5
24 x 24	Angled 2"	71RD24Q2(3)-SH.18	\$ 573	\$ 624	\$ 673	\$ 1,000	\$ 595

**NEW** 18"H Round with 4 columns

Top Size	Base	Model Number	3P	3K	3W	W1-W4	F1-F5
30 x 30	Angled 2"	71RD30Q2-SH.18	\$ 773	\$ 852	\$ 901	\$ 1,310	\$ 786
36 x 36	Angled 2"	71RD36Q2-SH.18	846	955	1,004	1,510	936
42 x 42	Angled 2"	71RD42Q2-SH.18	944	1,092	1,133	1,730	957
48 x 48	Angled 2"	71RD48Q2-SH.18	971	1,130	1,185	1,968	978
54 x 54	Angled 2"	71RD54Q2-SH.18	1,131	1,353	1,382	2,230	NA
60 x 60	Angled 2"	71RD60Q2-SH.18	1,153	1,384	1,428	2,507	NA



online updates

new product

clarification / edit

deletion

## SH.18 special height of 18"

Top Size	Base	Model Number	3P	3K	3W	W1-W4	F1-F5	18"H Rectangular with A configuration
20 x 36	Angled 2"	71TC2036Q2.A-SH.18	\$ 717	\$ 774	\$ 861	\$ 987	\$ 760	 
20 x 48	Angled 2"	71TC2048Q2.A-SH.18	763	838	939	1,091	777	
20 x 60	Angled 2"	71TC2060Q2.A-SH.18	784	868	990	1,191	865	
20 x 72	Angled 2"	71TC2072Q2.A-SH.18	824	923	1,061	1,295	903	
24 x 36	Angled 2"	71TC2436Q2.A-SH.18	717	774	870	1,029	821	
24 x 48	Angled 2"	71TC2448Q2.A-SH.18	763	838	948	1,137	838	
24 x 60	Angled 2"	71TC2460Q2.A-SH.18	784	868	999	1,249	903	
24 x 72	Angled 2"	71TC2472Q2.A-SH.18	824	923	1,070	1,356	936	
30 x 36	Angled 2"	71TC3036Q2.A-SH.18	751	821	921	1,091	865	
30 x 48	Angled 2"	71TC3048Q2.A-SH.18	808	901	1,011	1,214	875	
30 x 60	Angled 2"	71TC3060Q2.A-SH.18	826	926	1,058	1,333	1,035	
30 x 72	Angled 2"	71TC3072Q2.A-SH.18	870	988	1,135	1,453	1,111	
36 x 48	Angled 2"	71TC3648Q2.A-SH.18	853	964	1,074	1,287	925	
36 x 60	Angled 2"	71TC3660Q2.A-SH.18	921	1,059	1,177	1,418	1,132	
36 x 72	Angled 2"	71TC3672Q2.A-SH.18	963	1,119	1,252	1,549	1,253	

NEW

Exclaim

online updates

new product

clarification / edit

deletion

Top Size	Base	Model Number	3P	3K	3W	W1-W4	F1-F5	18"H Rectangular with V configuration
24 x 36	Angled 2"	71TC2436Q2.A-SH.18	\$ 717	\$ 774	\$ 870	\$ 1,029	\$ 821	 
24 x 48	Angled 2"	71TC2448Q2.A-SH.18	763	838	948	1,137	838	
24 x 60	Angled 2"	71TC2460Q2.A-SH.18	784	868	999	1,249	903	
24 x 72	Angled 2"	71TC2472Q2.A-SH.18	824	923	1,070	1,356	936	
30 x 36	Angled 2"	71TC3036Q2.A-SH.18	751	821	921	1,091	865	
30 x 48	Angled 2"	71TC3048Q2.A-SH.18	808	901	1,011	1,214	875	
30 x 60	Angled 2"	71TC3060Q2.A-SH.18	826	926	1,058	1,333	1,035	
30 x 72	Angled 2"	71TC3072Q2.A-SH.18	870	988	1,135	1,453	1,111	
36 x 48	Angled 2"	71TC3648Q2.A-SH.18	853	964	1,074	1,287	925	
36 x 60	Angled 2"	71TC3660Q2.A-SH.18	921	1,059	1,177	1,418	1,132	
36 x 72	Angled 2"	71TC3672Q2.A-SH.18	963	1,119	1,252	1,549	1,253	

NEW

LC  
NA

CCG  
NA

CH  
NA

WM  
NA

MMLC  
NA

PB  
NA

GR  
+40

CM  
+50

RC  
+55

GN  
+40

LT  
+115



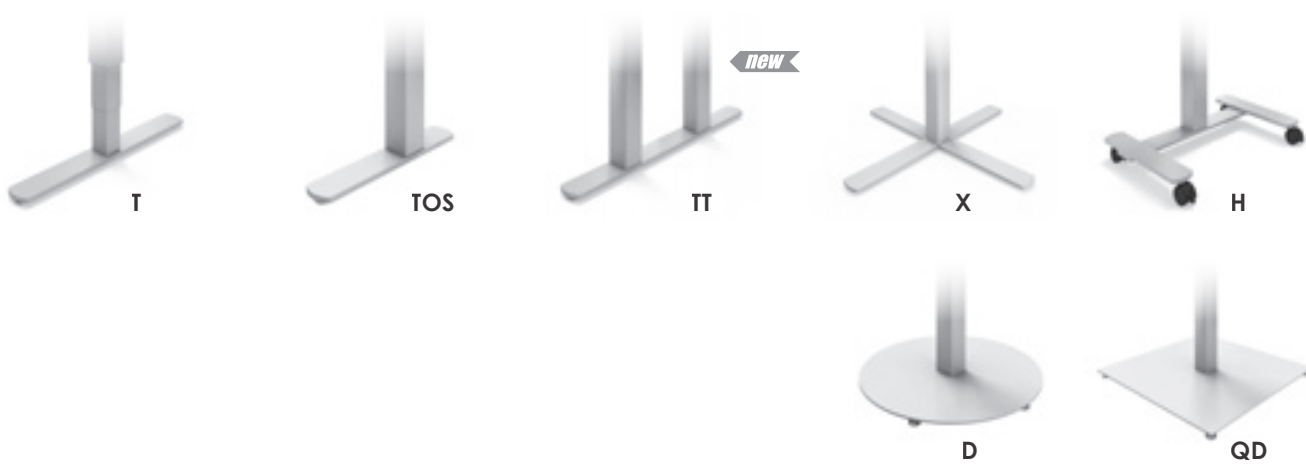

Height adjustability is becoming more important in the workplace. VertiGo is designed to go from seating height to standing height (and anywhere in between) with ease. Match with static or nesting tables for a cohesive look throughout the space.

### VertiGo Base Styles



### VertiGo Base Options

- 
**LC** **Locking Casters**  
 can be added to any table for \$90.
- 
**FD** **Folding Bases**  
 are not available on VertiGo tables.
- NE** **Nesting Tables**  
 priced accordingly with locking casters.
- FT** **Flip Tops**  
 available on X-based and H-based tables for \$125. Not available on counter-balanced tables.
- OS** **Offset Bases**  
 available for \$35.
- CH** **Chrome Finish**  
 is not available on VertiGo tables.
- WM** **Wire Management**  
 Built in wire management is not available on VertiGo tables.
- MMLC** **Magnet Wire Management Leg Covers**  
 Magnetically snap onto any square leg and are \$55 each.
- SH** **Special Height**  
 of can be added to any table:  
 + \$65 per column for heights > 29"  
 + \$35 per column for heights < 29"  
 Special height tables larger than 36x72" must be custom quoted.
- FR** **Footring**  
 is not available on VertiGo tables.

## VertiGo Base Finishes

**Static & nesting tables** are available in any standard TableX base finish.

**Ratchet tables** are available in any standard TableX base finish. The interior column is only available in three finishes:

- Black
- White
- Silver

**Counter-balanced, balanced short, electric, and hand crank tables** are available in three finishes:

- 02 Black
- 30 Pearl
- 37 Satin Silver

## VertiGo Top Shapes

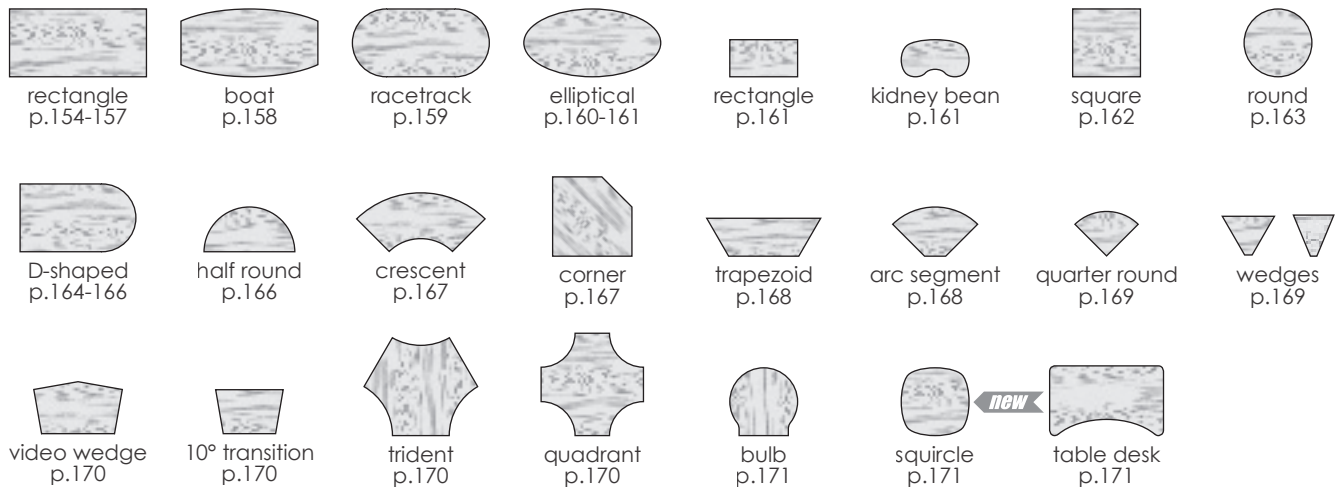

## VertiGo Top Options

**RC 3" Radius Corners** can be added to any table for \$55.

**GN Ganging Brackets** can be added to most table shapes for \$40.

**LT Lightweight Tops** can be added to any square or rectangular table for \$115.

**GR Grommets** can be added to any table for \$40 each. To see specific locations, see page 157.

**CM Cable Manager** can be added to any table for \$50 each. To see specific locations, see page 157.

## VertiGo Edge Options

(correspond with 5 columns of pricing)

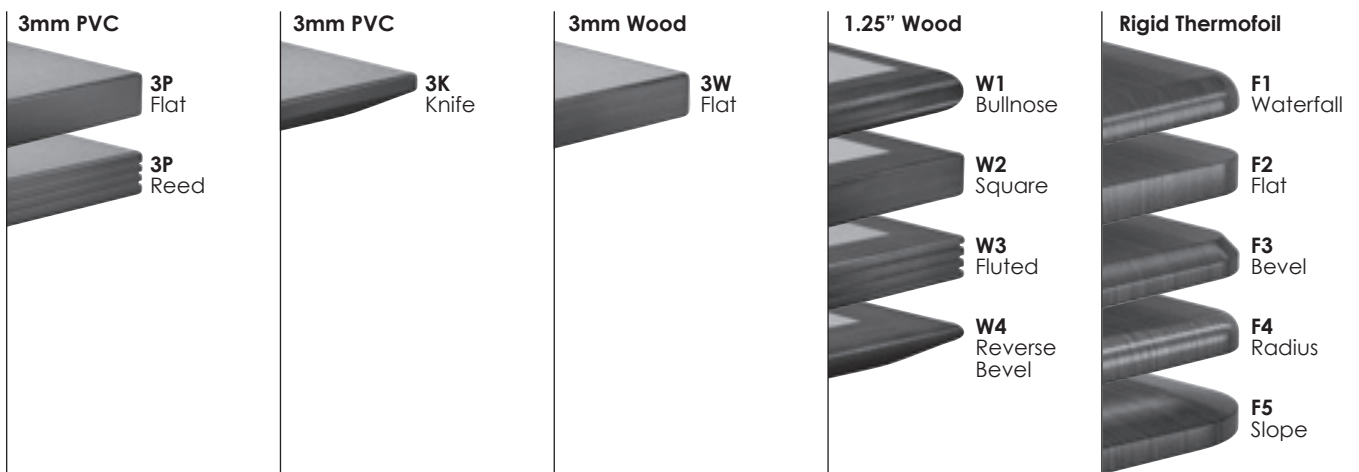

## ratchet height adjustability

Ratchet height adjustability is available on most tables in the VertiGo line... T-bases, X-bases, and even disc bases. Simply lift the top near the base's mounting plate, and the ratchet clicks into place. With a range of 9.45" the ratchet works in thirteen increments of .78". To reset to the lowest position just lift past its highest point.

Want to use VertiGo on the go? The height of the base will be adjusted to ensure that the range of mobile tables is consistent with that of static tables.

**To specify:**  
All available ratchet models are priced in the following pages. They are denoted by the "RA" at the end of the model number.

**Example:**  
74TC2060T18RA-3P  
20x60" **ratchet** table  
**\$1,029** List Price

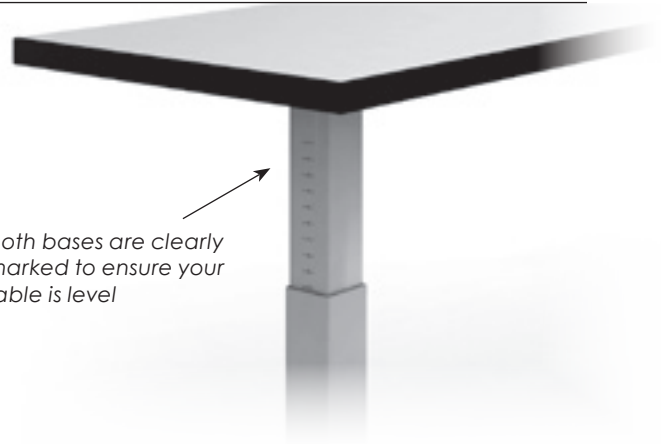

both bases are clearly marked to ensure your table is level

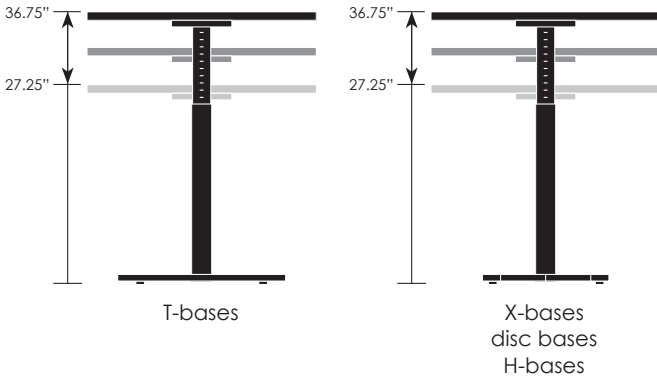

### nesting ratchet!

Ratchet height adjustability is also available on many of the nesting T-base models in the VertiGo line. All available nesting models are denoted by the "NE" at the end of the model number. To add the ratchet option to those models, change the "NE" to "NERA" and add \$400 to the list price.

**Example:**  
74TC2060T18NERA-3P  
20x60" **nesting ratchet** table  
**\$1,130 + 400 = 1,530** List Price

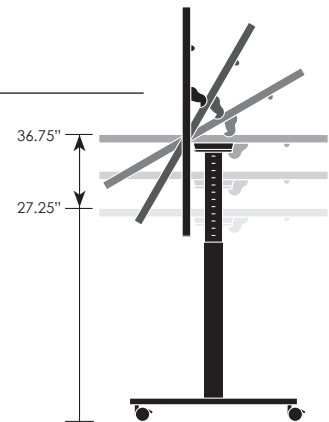

## manual hand crank height adjustability

Need the flexibility of infinite adjustability without the budget for counter balanced bases? Our manual hand crank offers a cost-effective alternative.

**Example:**  
74TC2060T18CR-3P  
20x60" **hand crank** table  
**\$1,154** List Price

**To specify:**  
All available hand crank models are priced in the following pages. They are denoted by the "CR" at the end of the model number.

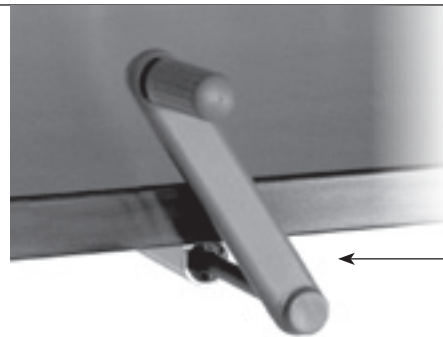

raise and lower with just the turn of the crank

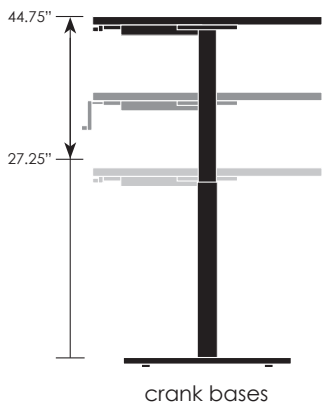

### new nesting hand crank!

Introducing hand crank height adjustable tables that nest! Only available on rectangular tables 20x60" to 36-72". These models are denoted by the "NECR" at the end of the model number.

**Example:**  
74TC2060T18NECR-3P  
20x60" **nesting hand crank** table  
**\$1,651** List Price





**new** electric height adjustability

Electric height adjustability gives you the ability to adjust tables at the push of a button. The standard memory keypad will remember your four favorite heights. Available on both VertiGo T and TT-bases, this option works great in private offices or even in conference rooms.

**To specify:**  
All available electric models are priced in the following pages. They are denoted by the "EH" at the end of the model number.

**Example:**  
74TC2060T18EH-3P  
20x60" electric height table  
**\$2,056** List Price

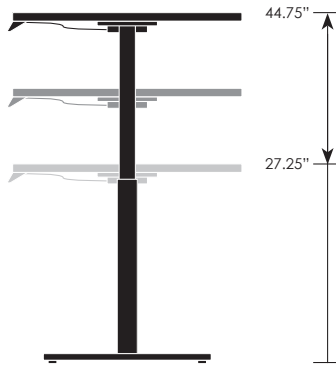

electric T-bases

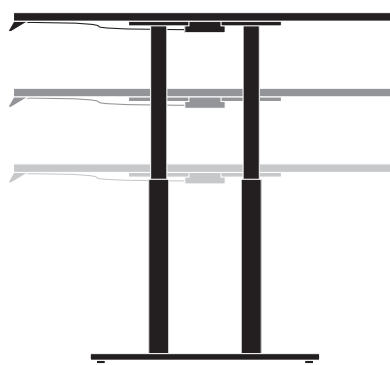

electric TT-bases



← Optional magnetic wire management leg cover.



retractable memory keypad

VertiGo

counter balanced & short balanced height adjustability

Counter balanced tables go from seated-to-standing height, while the short balanced goes from coffee-to-seated height. Available on tables using single column disc or X-bases, these tables are easy to adjust. Simply squeeze the small handle underneath and gently move the top to your desired height. It's that easy.

Want to use VertiGo on the go? Simply add 2" to each vertical measurement to account for the added height of locking casters.

**To specify:**  
All available counter balanced models are priced in the following pages. They are denoted by the "BL" or "BLS" (for short balanced) at the end of the model number.

**Example:**  
74RD36X32BL-3P  
36" round counter balanced table  
**\$1,130** List Price

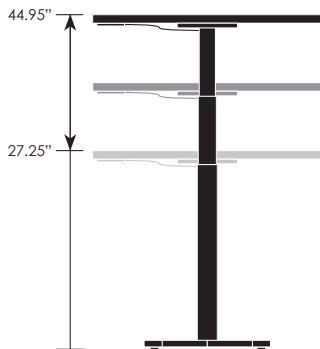

BL: counter balanced disc or X-bases

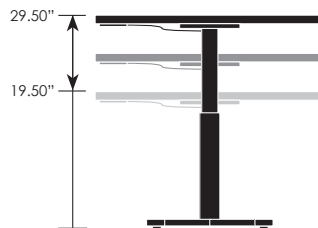

**new** BLS: short balanced disc or X-bases

just squeeze the handle and it glides so smoothly!



Rectangular with T-bases	Top Size	Base	Model Number	3P	3K	3W	W1-W4	F1-F5
	20 x 36	Static	74TC2036T18	\$ 556	\$ 613	\$ 699	\$ 826	\$ 591
		Nesting	74TC2036T18NE	981	1,037	1,122	NA	1,056
		Ratchet	74TC2036T18RA	962	1,018	1,105	1,231	1,017
		Crank	74TC2036T18CR	1,087	1,144	1,230	1,357	1,148
		Electric	74TC2036T18EH	1,989	2,045	2,132	2,258	2,095
	20 x 48	Static	74TC2048T18	602	677	778	930	608
		Nesting	74TC2048T18NE	1,053	1,127	1,226	NA	1,102
		Ratchet	74TC2048T18RA	1,007	1,082	1,183	1,335	1,034
		Crank	74TC2048T18CR	1,133	1,208	1,309	1,461	1,166
		Electric	74TC2048T18EH	2,034	2,110	2,210	2,362	2,112
	20 x 60	Static	74TC2060T18	623	707	829	1,030	696
		Nesting	74TC2060T18NE	1,130	1,212	1,332	NA	1,247
		Ratchet	74TC2060T18RA	1,029	1,112	1,234	1,435	1,122
		Crank	74TC2060T18CR	1,154	1,238	1,360	1,561	1,253
		Nest/Crank	74TC2060T18NECR	1,651	1,733	1,853	NA	1,794
20 x 72	Static	74TC2072T18	731	830	968	1,202	805	
	Nesting	74TC2072T18NE	1,347	1,444	1,580	NA	1,495	
	Ratchet	74TC2072T18RA	1,136	1,236	1,374	1,607	1,231	
	Crank	74TC2072T18CR	1,262	1,361	1,499	1,733	1,363	
	Nest/Crank	74TC2072T18NECR	1,868	1,965	2,100	NA	2,042	
20 x 84	Static	74TC2084T18	808	938	1,080	1,306	927	
	Nesting	74TC2084T18NE	1,422	1,550	1,690	NA	1,615	
	Electric	74TC2084T18EH	2,240	2,371	2,513	2,738	2,431	
	20 x 90	Static	74TC2090T18	854	1,002	1,145	1,356	927
		Nesting	74TC2090T18NE	1,467	1,613	1,753	NA	1,615
Electric		74TC2090T18EH	2,286	2,435	2,577	2,788	2,431	
20 x 96	Static	74TC2096T18	854	1,002	1,159	1,406	948	
	Nesting	74TC2096T18NE	1,467	1,613	1,766	NA	1,636	
	Electric	74TC2096T18EH	2,286	2,435	2,591	2,838	2,452	
24 x 36	Static	74TC2436T22	570	627	723	883	667	
	Nesting	74TC2436T22NE	995	1,051	1,145	NA	1,131	
	Ratchet	74TC2436T22RA	976	1,033	1,129	1,288	1,093	
	Crank	74TC2436T22CR	1,099	1,156	1,252	1,411	1,222	
	Electric	74TC2436T22EH	2,003	2,059	2,155	2,315	2,171	
24 x 48	Static	74TC2448T22	616	691	801	990	684	
	Nesting	74TC2448T22NE	1,073	1,148	1,258	NA	1,184	
	Ratchet	74TC2448T22RA	1,022	1,097	1,207	1,396	1,110	
	Crank	74TC2448T22CR	1,250	1,325	1,435	1,624	1,349	
	Electric	74TC2448T22EH	2,048	2,124	2,233	2,423	2,188	

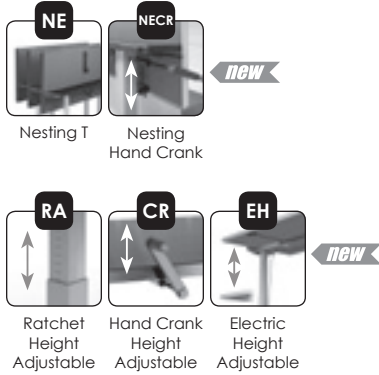

Vertigo

Top Size	Base	Model Number	3P	3K	3W	W1-W4	F1-F5	Rectangular with T-bases
24 x 60	Static	74TC2460T22	\$ 638	\$ 721	\$ 852	\$ 1,102	\$ 749	
	Nesting	74TC2460T22NE	1,144	1,226	1,355	NA	1,299	
	Ratchet	74TC2460T22RA	1,043	1,127	1,258	1,508	1,175	
	Crank	74TC2460T22CR	1,166	1,250	1,381	1,630	1,303	
	Nest/Crank	74TC2460T18NECR	1,663	1,745	1,873	NA	1,843	
	Electric	74TC2460T22EH	2,070	2,153	2,285	2,534	2,252	
24 x 72	Static	74TC2472T22	677	777	924	1,210	782	
	Nesting	74TC2472T22NE	1,361	1,459	1,603	NA	1,543	
	Ratchet	74TC2472T22RA	1,083	1,182	1,329	1,615	1,208	
	Crank	74TC2472T22CR	1,206	1,305	1,452	1,738	1,337	
	Nest/Crank	74TC2472T18NECR	1,879	1,977	2,121	NA	2,087	
	Electric	74TC2472T22EH	2,109	2,209	2,356	2,642	2,286	
24 x 84	Static	74TC2484T22	822	952	1,104	1,389	1,018	
	Nesting	74TC2484T22NE	1,436	1,564	1,713	NA	1,704	
	Electric	74TC2472T22EH	2,254	2,385	2,536	2,822	2,522	
24 x 90	Static	74TC2490T22	868	1,017	1,168	1,443	1,028	
	Nesting	74TC2490T22NE	1,481	1,627	1,776	NA	1,714	
	Electric	74TC2472T22EH	2,300	2,449	2,601	2,875	2,532	
24 x 96	Static	74TC2496T22	868	1,017	1,182	1,497	1,039	
	Nesting	74TC2496T22NE	1,481	1,627	1,790	NA	1,725	
	Electric	74TC2472T22EH	2,300	2,449	2,614	2,929	2,543	
30 x 36	Static	74TC3036T26	619	689	789	959	726	
	Nesting	74TC3036T26NE	1,043	1,112	1,209	NA	1,189	
	Ratchet	74TC3036T26RA	1,025	1,096	1,195	1,365	1,153	
	Crank	74TC3036T26CR	1,146	1,217	1,316	1,486	1,280	
	Electric	74TC3036T26EH	2,051	2,121	2,221	2,390	2,229	
30 x 48	Static	74TC3048T26	676	769	879	1,082	737	
	Nesting	74TC3048T26NE	1,126	1,217	1,325	NA	1,228	
	Ratchet	74TC3048T26RA	1,082	1,175	1,285	1,488	1,163	
	Crank	74TC3048T26CR	1,203	1,296	1,406	1,609	1,290	
	Electric	74TC3048T26EH	2,108	2,201	2,311	2,514	2,240	
30 x 60	Static	74TC3060T26	693	794	926	1,201	896	
	Nesting	74TC3060T26NE	1,199	1,297	1,428	NA	1,444	
	Ratchet	74TC3060T26RA	1,100	1,200	1,333	1,607	1,323	
	Crank	74TC3060T26CR	1,221	1,321	1,454	1,728	1,450	
	Nest/Crank	74TC3060T26NECR	1,716	1,815	1,945	NA	1,987	
	Electric	74TC3060T26EH	2,125	2,225	2,358	2,633	2,400	





VertiGo

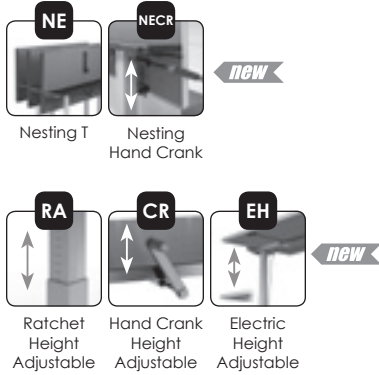

- LC**  
+90
- OS**  
+35
- CH**  
NA
- WM**  
NA
- MMC**  
+55
- FT**  
NA
- SH**  
T+130
- FR**  
NA
- GR**  
+40
- CM**  
+50
- RC**  
+55
- GN**  
+40
- LT**  
+115
- RA**  
NE+400

Rectangular with T-bases	Top Size	Base	Model Number	3P	3K	3W	W1-W4	F1-F5
	30 x 72	Static	74TC3072T26	\$ 738	\$ 856	\$ 1,003	\$ 1,320	\$ 972
		Nesting	74TC3072T26NE	1,421	1,536	1,680	NA	1,729
		Ratchet	74TC3072T26RA	1,144	1,262	1,409	1,727	1,399
		Crank	74TC3072T26CR	1,265	1,383	1,530	1,848	1,526
		Nest/Crank	74TC3072T26NECR	1,938	2,053	2,198	NA	2,272
		Electric	74TC3072T26EH	2,170	2,288	2,435	2,752	2,475
	30 x 84	Static	74TC3084T26	914	1,076	1,218	1,508	1,054
		Nesting	74TC3084T26NE	1,527	1,685	1,825	NA	1,740
		Electric	74TC3072T26EH	2,346	2,507	2,650	2,940	2,558
	30 x 90	Static	74TC3090T26	971	1,155	1,294	1,569	1,075
		Nest/Lightwt	74TC3090T26NE-LT	1,696	NA	2,024	NA	NA
		Electric	74TC3072T26EH	2,403	2,587	2,726	3,001	2,579
	30 x 96	Static	74TC3096T26	971	1,155	1,308	1,627	1,086
		Nest/Lightwt	74TC3096T26NE-LT	1,696	NA	2,038	NA	NA
		Electric	74TC3072T26EH	2,403	2,587	2,740	3,059	2,589
	36 x 48	Static	74TC3648T26	721	832	942	1,155	787
		Nesting	74TC3648T26NE	1,329	1,438	1,546	NA	1,469
		Ratchet	74TC3648T26RA	1,127	1,238	1,349	1,561	1,213
Crank		74TC3648T26CR	1,248	1,359	1,470	1,682	1,340	
Electric		74TC3648T26EH	2,152	2,263	2,374	2,587	2,290	
36 x 60		Static	74TC3660T26	788	927	1,045	1,286	993
	Nesting	74TC3660T26NE	1,450	1,586	1,702	NA	1,729	
	Ratchet	74TC3660T26RA	1,195	1,333	1,451	1,692	1,420	
	Crank	74TC3660T26CR	1,316	1,454	1,572	1,813	1,547	
	Nest/Crank	74TC3660T26NECR	1,968	2,103	2,219	NA	2,272	
	Electric	74TC3660T26EH	2,220	2,358	2,476	2,718	2,497	
36 x 72	Static	74TC3672T26	831	987	1,119	1,417	1,114	
	Nesting	74TC3672T26NE	1,512	1,664	1,795	NA	1,869	
	Ratchet	74TC3672T26RA	1,238	1,393	1,526	1,823	1,541	
	Crank	74TC3672T26CR	1,358	1,514	1,647	1,944	1,668	
	Nest/Crank	74TC3672T26NECR	2,029	2,182	2,312	NA	2,412	
	Electric	74TC3672T26EH	2,263	2,418	2,551	2,848	2,617	
36 x 84	Static	74TC3684T26	992	1,185	1,317	1,616	1,207	
	Nest/Lightwt	74TC3684T26NE-LT	1,716	NA	2,047	NA	NA	
	Electric	74TC3672T26EH	2,424	2,617	2,749	3,047	2,710	
36 x 90	Static	74TC3690T26	1,059	1,278	1,405	1,681	1,217	
	Nest/Lightwt	74TC3690T26NE-LT	1,782	NA	2,133	NA	NA	
	Electric	74TC3672T26EH	2,491	2,710	2,837	3,113	2,721	
36 x 96	Static	74TC3696T26	1,059	1,278	1,419	1,746	1,223	
	Nest/Lightwt	74TC3696T26NE-LT	1,782	NA	2,146	NA	NA	
	Electric	74TC3672T26EH	2,491	2,710	2,851	3,178	2,726	



Vertigo

Top Size	Base	Model Number	3P	3K	3W	W1-W4	F1-F5	Rectangular with TT-bases	NEW
42 x 60	Static	74TC4260TT32	\$ 1,212	\$ 1,374	\$ 1,488	\$ 1,731	\$ 1,366	   	
	Nesting	74TC4260TT32NE	1,987	2,146	2,258	NA	2,222		
	Electric	74TC4260TT32EH	3,943	4,105	4,219	4,462	4,233		
42 x 72	Static	74TC4272TT32	1,293	1,487	1,605	1,874	1,497		
	Nesting	74TC4272TT32NE	2,066	2,257	2,372	NA	2,351		
	Electric	74TC4272TT32EH	4,024	4,218	4,308	4,605	4,364		
42 x 84	Static	74TC4284TT32	1,439	1,664	1,786	2,084	1,590		
	Electric	74TC4284TT32EH	4,169	4,395	4,461	4,815	4,457		
42 x 90	Static	74TC4290TT32	1,514	1,769	1,882	2,154	1,611		
	Electric	74TC4290TT32EH	4,245	4,500	4,544	4,884	4,478		
42 x 96	Static	74TC4296TT32	1,514	1,769	1,896	2,227	1,621		
	Electric	74TC4296TT32EH	4,245	4,500	4,544	4,957	4,489		
48 x 60	Static	74TC4860TT36	1,294	1,478	1,589	1,840	1,502		
	Nesting	74TC4860TT36NE	2,067	2,248	2,357	NA	2,355		
	Electric	74TC4860TT36EH	4,015	4,200	4,297	4,561	4,359		
48 x 72	Static	74TC4872TT36	1,386	1,608	1,719	1,994	1,633		
	Nesting	74TC4872TT36NE	2,157	2,375	2,484	NA	2,484		
	Electric	74TC4872TT36EH	4,107	4,329	4,398	4,715	4,491		
48 x 84	Static	74TC4884TT36	1,462	1,687	1,823	2,212	1,726		
	Electric	74TC4884TT36EH	4,184	4,409	4,475	4,933	4,583		
48 x 90	Static	74TC4890TT36	1,538	1,794	1,921	2,289	1,768		
	Electric	74TC4890TT36EH	4,260	4,515	4,559	5,010	4,626		
48 x 96	Static	74TC4896TT36	1,538	1,794	1,935	2,366	1,779		
	Electric	74TC4896TT36EH	4,260	4,515	4,559	5,087	4,636		

Top Size	Base	Model Number	3P	3K	3W	W1-W4	F1-F5	Rectangular with 3 TT-bases	NEW
42 x 120	Static	74TC42120TT32(3)	\$ 2,198	\$ 2,577	\$ 2,667	\$ 2,883	2,680	 	
42 x 144	Static	74TC42144TT32(3)	2,354	2,795	2,893	3,164	2,701		
48 x 120	Static	74TC48120TT36(3)	2,243	2,626	2,727	3,057	2,770		
48 x 144	Static	74TC48144TT36(3)	2,400	2,846	2,955	3,357	2,823		

3 bases: **LC** **SH**  
+135 quote

- LC**  
+90
- OS**  
+35
- CH**  
NA
- WM**  
NA
- MMLC**  
+55
- FT**  
NA
- SH**  
T+130  
TT+260
- FR**  
NA
- GR**  
+40
- CM**  
+50
- RC**  
+55
- GN**  
+40
- LT**  
+115
- RA**  
NA

Boat-shaped with T-bases	Top Size	Base	Model Number	3P	3K	3W	W1-W4	F1-F5
	30 x 42 x 84	Static	74BT3084T26	\$ 1,275	\$ 1,580	\$ 1,601	\$ 2,320	\$ 1,341
		Electric	74BT3084T26EH	2,707	3,012	3,032	3,752	2,845
	30 x 42 x 90	Static	74BT3090T26	1,383	1,732	1,734	2,420	1,367
		Electric	74BT3090T26EH	2,815	3,164	3,165	3,852	2,870
	30 x 42 x 96	Static	74BT3096T26	1,383	1,732	1,747	2,516	1,379
		Electric	74BT3090T26EH	2,815	3,164	3,179	3,948	2,883



VertiGo

**NEW**

Boat-shaped with TT-bases	Top Size	Base	Model Number	3P	3K	3W	W1-W4	F1-F5
	36 x 48 x 84	Static	74BT3684TT36	\$ 1,771	\$ 2,119	\$ 2,115	\$ 2,851	1,762
		Electric	74BT3684TT36EH	4,492	4,840	4,836	5,572	4,619
	36 x 48 x 90	Static	74BT3690TT36	1,894	2,292	2,264	2,954	1,814
		Electric	74BT3690TT36EH	4,615	5,013	4,986	5,676	4,672
	36 x 48 x 96	Static	74BT3696TT36	1,894	2,292	2,278	3,054	1,827
		Electric	74BT3696TT36EH	4,615	5,013	4,999	5,776	4,684

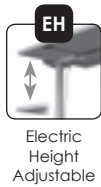







**NEW**

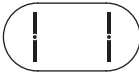

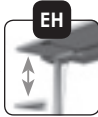
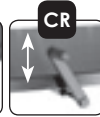
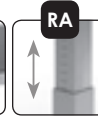
Boat-shaped with 3 TT-bases	Top Size	Base	Model Number	3P	3K	3W	W1-W4	F1-F5
	36 x 48 x 120	Static	74BT36120TT36(3)	\$ 2,681	\$ 3,239	\$ 3,161	\$ 3,849	2,770
	36 x 48 x 144	Static	74BT36144TT36(3)	2,927	3,584	3,487	4,261	2,823

3 bases: **LC** **SH**  
+135 quote

- LC**  
+90
- OS**  
+35
- CH**  
NA
- WM**  
NA
- MMLC**  
+55
- FT**  
NA
- SH**  
T+130  
TT+260
- FR**  
NA
- GR**  
+40
- CM**  
+50
- RC**  
+55
- GN**  
+40
- LT**  
+115



Top Size	Base	Model Number	3P	3K	3W	W1-W4	F1-F5	Racetrack with T-bases
36 x 60	Static	74RT3672T26	\$ 916	\$ 1,106	\$ 1,150	\$ 1,748	\$ 1,099	      <p>Electric Height Adjustable    Hand Crank Height Adjustable    Ratchet Height Adjustable</p>
	Nesting	74RT3660T26NE	1,521	1,707	1,750	NA	1,776	
	Ratchet	74RT3672T26RA	1,323	1,512	1,556	2,154	1,526	
	Crank	74RT3672T26CR	1,444	1,633	1,677	2,275	1,653	
	Electric	74RT3672T26EH	2,348	2,537	2,581	3,179	2,603	
36 x 72	Static	74RT3672T26	1,007	1,232	1,277	1,928	1,244	
	Nesting	74RT3672T26NE	1,665	1,886	1,930	NA	1,976	
	Ratchet	74RT3672T26RA	1,413	1,639	1,683	2,335	1,671	
	Crank	74RT3672T26CR	1,534	1,760	1,804	2,456	1,798	
	Electric	74RT3672T26EH	2,439	2,664	2,709	3,360	2,748	
36 x 84	Static	74RT3684T26	1,170	1,433	1,477	2,181	1,341	
	Electric	74RT3684T26EH	2,601	2,865	2,909	3,613	2,845	
36 x 90	Static	74RT3690T26	1,292	1,604	1,625	2,274	1,354	
	Electric	74RT3690T26EH	2,724	3,036	3,057	3,705	2,857	
36 x 96	Static	74RT3696T26	1,292	1,604	1,639	2,362	1,360	
	Electric	74RT3696T26EH	2,724	3,036	3,071	3,794	2,864	

Top Size	Base	Model Number	3P	3K	3W	W1-W4	F1-F5	Racetrack with TT-bases <span style="float:right">NEW</span>
42 x 84	Static	74RT4284TT32	\$ 1,637	\$ 1,942	\$ 1,963	\$ 2,685	\$ 1,724	   <p>Electric Height Adjustable</p>
	Electric	74RT4284TT32EH	4,368	4,672	4,693	5,415	4,592	
42 x 90	Static	74RT4290TT32	1,748	2,097	2,098	2,785	1,750	
	Electric	74RT4290TT32EH	4,479	4,828	4,829	5,515	4,617	
42 x 96	Static	74RT4296TT32	1,748	2,097	2,112	2,881	1,762	
	Electric	74RT4296TT32EH	4,479	4,828	4,843	5,612	4,630	
48 x 84	Static	74RT4884TT36	1,894	2,292	2,250	2,851	1,762	
	Electric	74RT4884TT36EH	4,615	5,013	4,972	5,572	4,619	
48 x 90	Static	74RT4890TT36	1,894	2,292	2,264	2,954	1,813	
	Electric	74RT4890TT36EH	4,615	5,013	4,986	5,676	4,670	
48 x 96	Static	74RT4896TT36	1,894	2,292	2,278	3,054	1,825	
	Electric	74RT4896TT36EH	4,615	5,013	4,999	5,776	4,682	

Top Size	Base	Model Number	3P	3K	3W	W1-W4	F1-F5	Racetrack with TT-bases <span style="float:right">NEW</span>
42 x 120	Static	74RT42120TT32(3)	\$ 2,632	\$ 3,184	\$ 3,102	\$ 3,641	\$ 2,680	 
42 x 144	Static	74RT42144TT32(3)	2,876	3,526	3,426	4,029	2,701	
48 x 120	Static	74RT48120TT36(3)	2,681	3,239	3,161	3,849	2,770	
48 x 144	Static	74RT48144TT36(3)	2,928	3,584	3,488	4,261	2,823	

3 bases: **LC** **SH**  
+135 quote

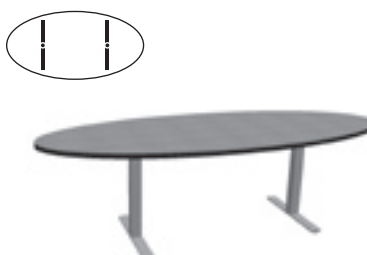
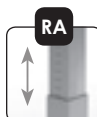
- LC**  
+90
- OS**  
+35
- CH**  
NA
- WM**  
NA
- MMLC**  
+55
- FT**  
NA
- SH**  
T+130  
TT+260
- FR**  
NA
- GR**  
+40
- CM**  
+50
- RC**  
+55
- GN**  
+40
- LT**  
+115
- RA**  
NE+400

Elliptical with T-bases	Top Size	Base	Model Number	3P	3K	3W	W1-W4	F1-F5
   Ratchet Height Adjustable    Electric Height Adjustable	30 x 54	Static	74EL3054T22	\$ 785	\$ 927	\$ 973	\$ 1,529	\$ 857
		Ratchet	74EL3054T22RA	1,190	1,333	1,378	1,935	1,283
		Electric	74EL3054T22EH	2,217	2,359	2,405	2,961	2,361
	30 x 60	Static	74EL3060T22	822	980	1,025	1,614	881
		Ratchet	74EL3060T22RA	1,228	1,385	1,430	2,019	1,307
		Electric	74EL3060T22EH	2,255	2,412	2,457	3,046	2,385
	36 x 60	Static	74EL3660T26	916	1,106	1,138	1,748	993
		Ratchet	74EL3660T26RA	1,323	1,512	1,544	2,154	1,420
		Electric	74EL3660T26EH	2,348	2,537	2,570	3,179	2,497
	36 x 72	Static	74EL3672T26	1,007	1,232	1,259	1,928	1,114
		Ratchet	74EL3672T26RA	1,413	1,639	1,665	2,335	1,541
		Electric	74EL3672T26EH	2,439	2,664	2,691	3,360	2,617
36 x 84	Static	74EL3684T26	1,170	1,433	1,453	2,181	1,207	
	Electric	74EL3684T26EH	2,601	2,865	2,885	3,613	2,710	
36 x 90	Static	74EL3690T26	1,292	1,604	1,598	2,274	1,253	
	Electric	74EL3690T26EH	2,724	3,036	3,030	3,705	2,756	
36 x 96	Static	74EL3696T26	1,292	1,604	1,609	2,362	1,278	
	Electric	74EL3696T26EH	2,724	3,036	3,041	3,794	2,782	

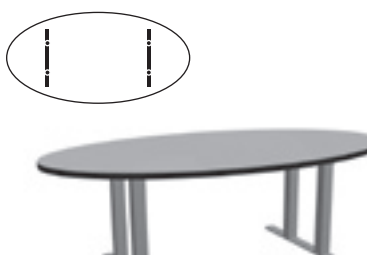
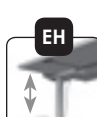
Elliptical with TT-bases	Top Size	Base	Model Number	3P	3K	3W	W1-W4	F1-F5
  Electric Height Adjustable	42 x 72	Static	74EL4272TT32	\$ 1,466	\$ 1,730	\$ 1,739	\$ 2,424	\$ 1,497
		Electric	74EL4272TT32EH	4,197	4,461	4,470	5,155	4,364
	42 x 84	Static	74EL4284TT32	1,637	1,942	1,942	2,685	1,590
		Electric	74EL4284TT32EH	4,368	4,672	4,673	5,415	4,457
	42 x 90	Static	74EL4290TT32	1,750	2,100	2,077	2,785	1,611
		Electric	74EL4290TT32EH	4,481	4,830	4,807	5,515	4,478
	42 x 96	Static	74EL4296TT32	1,750	2,100	2,088	2,881	1,621
		Electric	74EL4296TT32EH	4,481	4,830	4,818	5,612	4,489
	48 x 72	Static	74EL4872TT36	1,612	1,924	1,908	2,578	1,633
		Electric	74EL4872TT36EH	4,333	4,646	4,629	5,300	4,491
	48 x 84	Static	74EL4884TT36	1,692	2,009	2,011	2,851	1,726
		Electric	74EL4884TT36EH	4,413	4,730	4,732	5,572	4,583
48 x 90	Static	74EL4890TT36	1,894	2,292	2,244	2,954	1,768	
	Electric	74EL4890TT36EH	4,616	5,013	4,965	5,676	4,626	
48 x 96	Static	74EL4896TT36	1,894	2,292	2,255	3,054	1,779	
	Electric	74EL4896TT36EH	4,616	5,013	4,976	5,776	4,636	

- LC**  
+90
- OS**  
+35
- CH**  
NA
- WM**  
NA
- MMLC**  
+55
- FT**  
NA
- SH**  
T+130  
TT+260
- FR**  
NA
- GR**  
+40
- CM**  
+50
- RC**  
+55
- GN**  
+40
- LT**  
+115





Top Size	Base	Model Number	3P	3K	3W	W1-W4	F1-F5	Elliptical with 3 TT-bases
42 x 120	Static	74EL42120TT32(3)	2,632	3,184	3,064	3,641	2,680	
42 x 144	Static	74EL42144TT32(3)	2,876	3,526	3,376	4,029	2,701	
48 x 120	Static	74EL48120TT36(3)	2,681	3,239	3,125	3,849	2,770	
48 x 144	Static	74EL48144TT36(3)	2,928	3,584	3,440	4,261	2,823	

3 bases: **LC** **SH**  
+135 quote



Top Size	Base	Model Number	3P	3K	3W	W1-W4	F1-F5	Rectangle with H-base
18 x 30	Static	74TC1830H1524	\$ 780	\$ 823	\$ 901	\$ 1,211	\$ 839	
	Ratchet	74TC1830H1524RA	929	972	1,051	1,360	995	
	Crank	74TC1830H1524CR	985	1,028	1,107	1,417	1,055	
	Count Bal	74TC1830H1524BL	1,226	1,269	1,347	1,657	1,307	
18 x 36	Static	74TC1836H1524	780	823	915	1,211	839	
	Ratchet	74TC1836H1524RA	929	972	1,064	1,360	995	
	Crank	74TC1836H1524CR	985	1,028	1,121	1,417	1,055	
	Count Bal	74TC1836H1524BL	1,226	1,269	1,361	1,657	1,307	
20 x 30	Static	74TC2030H1524	814	871	943	1,238	907	
	Ratchet	74TC2030H1524RA	963	1,020	1,093	1,387	1,063	
	Crank	74TC2030H1524CR	1,019	1,076	1,149	1,443	1,123	
	Count Bal	74TC2030H1524BL	1,260	1,317	1,390	1,684	1,375	
20 x 36	Static	74TC2036H1524	814	871	957	1,238	907	
	Ratchet	74TC2036H1524RA	963	1,020	1,106	1,387	1,063	
	Crank	74TC2036H1524CR	1,019	1,076	1,163	1,443	1,123	
	Count Bal	74TC2036H1524BL	1,260	1,317	1,403	1,684	1,375	

Top Size	Base	Model Number	3P	3K	3W	W1-W4	F1-F5	Kidney Bean with H-base
18 x 30	Static	74KB1830H1524	\$ 884	\$ 968	\$ 1,027	NA	\$ 832	
	Ratchet	74KB1830H1524RA	1,033	1,117	1,176	NA	989	
	Count Bal	74KB1830H1524BL	1,330	1,414	1,473	NA	1,301	
18 x 36	Static	74KB1836H1524	895	984	1,055	NA	846	
	Ratchet	74KB1836H1524RA	1,044	1,134	1,204	NA	1,002	
	Count Bal	74KB1836H1524BL	1,341	1,431	1,501	NA	1,314	
20 x 30	Static	74KB2030H1524	895	984	1,044	NA	887	
	Ratchet	74KB2030H1524RA	1,044	1,134	1,194	NA	1,044	
	Count Bal	74KB2030H1524BL	1,341	1,431	1,491	NA	1,356	
20 x 36	Static	74KB2036H1524	903	995	1,068	NA	914	
	Ratchet	74KB2036H1524RA	1,052	1,144	1,217	NA	1,071	
	Count Bal	74KB2036H1524BL	1,349	1,441	1,514	NA	1,383	

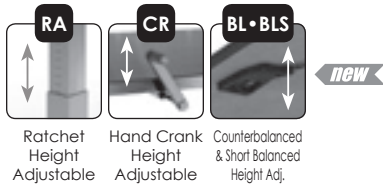

- LC**  
+90
- OS**  
NA
- CH**  
NA
- WM**  
NA
- MMLC**  
+55
- FT**  
NA
- SH**  
H+65
- FR**  
NA
- GR**  
+40
- CM**  
+50
- RC**  
NA
- GN**  
NA
- LT**  
NA

Square with X-base	Top Size	Base	Model Number	3P	3K	3W	W1-W4	F1-F5
 	24 x 24	Static	74SQ2424X22	\$ 562	\$ 600	\$ 683	\$ 813	\$ 616
		Ratchet	74SQ2424X22RA	711	750	832	962	773
		Crank	74SQ2424X22CR	767	805	887	1,017	831
		Short Bal	74SQ2424X22BLS	930	968	1,050	1,180	1,002
	30 x 30	Static	74SQ3030X26	628	687	781	939	687
		Ratchet	74SQ3030X26RA	777	836	931	1,088	844
		Crank	74SQ3030X26CR	832	891	985	1,142	901
		Short Bal	74SQ3030X26BLS	993	1,052	1,146	1,304	1,071
	36 x 36	Static	74SQ3636X32	705	789	892	1,076	852
		Short Bal	74SQ3636X32BLS	1,069	1,153	1,256	1,440	1,234
		Count Bal	74SQ3636X32BL	1,069	1,153	1,256	1,440	1,234
	42 x 42	Static	74SQ4242X36	793	906	1,015	1,225	888
Short Bal		74SQ4242X36BLS	1,154	1,267	1,376	1,587	1,268	
Count Bal		74SQ4242X36BL	1,154	1,267	1,376	1,587	1,268	



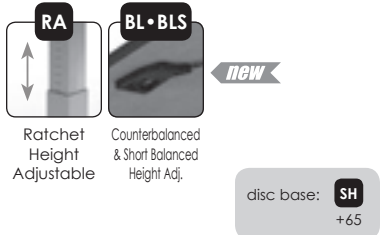

Square with square disc-base	Top Size	Base	Model Number	3P	3K	3W	W1-W4	F1-F5
 	24 x 24	Static	74SQ2424QD16	\$ 572	\$ 610	\$ 692	\$ 822	\$ 626
		Ratchet	74SQ2424QD16RA	725	764	846	976	788
		Short Bal	74SQ2424QD16BLS	1,062	1,101	1,183	1,313	1,141
	30 x 30	Static	74SQ3030QD16	623	682	776	934	682
		Ratchet	74SQ3030QD16RA	777	836	930	1,087	843
		Short Bal	74SQ3030QD16BLS	1,114	1,173	1,267	1,424	1,197
	36 x 36	Static	74SQ3636QD20	715	799	902	1,086	862
		Short Bal	74SQ3636QD20BLS	1,206	1,289	1,393	1,577	1,378
		Count Bal	74SQ3636QD20BL	1,208	1,292	1,395	1,579	1,380
	42 x 42	Static	74SQ4242QD26	886	999	1,108	1,318	986
		Short Bal	74SQ4242QD26BLS	1,371	1,484	1,593	1,803	1,495
		Count Bal	74SQ4242QD26BL	1,373	1,487	1,596	1,806	1,498



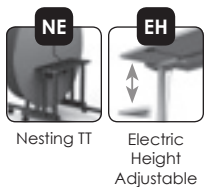



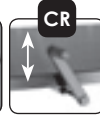
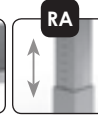

Square with TT-bases	Top Size	Base	Model Number	3P	3K	3W	W1-W4	F1-F5
 	48 x 48	Static	74SQ4848TT36	\$ 1,199	\$ 1,346	\$ 1,457	\$ 1,690	\$ 1,247
		Nesting	74SQ4848TT36NE	1,974	2,118	2,227	NA	2,106
		Electric	74SQ4848TT36EH	3,920	4,067	4,178	4,411	4,105



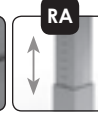

- LC +90
- OS NA
- CH NA
- WM NA
- MMLC +55
- FT X+125
- SH X,D+65 TT+260
- FR NA
- GR +40
- CM +50
- RC +55
- GN +40
- LT +115

Top Size	Base	Model Number	3P	3K	3W	W1-W4	F1-F5	Round with X-base
24 x 24	Static	74RD24X22	\$ 594	\$ 645	\$ 694	\$ 1,020	\$ 616	     Counterbalanced & Short Balanced Height Adj.    Hand Crank Height Adjustable    Ratchet Height Adjustable
	Ratchet	74RD24X22RA	743	794	843	1,170	773	
	Crank	74RD24X22CR	799	850	898	1,225	831	
	Short Bal	74RD24X22BLS	962	1,013	1,061	1,388	1,002	
30 x 30	Static	74RD30X26	678	757	807	1,216	687	
	Ratchet	74RD30X26RA	827	906	956	1,365	844	
	Crank	74RD30X26CR	882	961	1,010	1,419	901	
	Short Bal	74RD30X26BLS	1,043	1,122	1,172	1,581	1,071	
36 x 36	Static	74RD36X32	766	875	924	1,430	852	
	Short Bal	74RD36X32BLS	1,130	1,239	1,288	1,794	1,234	
	Count Bal	74RD36X32BL	1,130	1,239	1,288	1,794	1,234	
42 x 42	Static	74RD42X32	864	1,012	1,053	1,650	873	
	Short Bal	74RD42X32BLS	1,228	1,376	1,417	2,014	1,255	
	Count Bal	74RD42X32BL	1,228	1,376	1,417	2,014	1,255	
48 x 48	Static	74RD48X36	906	1,064	1,120	1,903	909	
	Short Bal	74RD48X36BLS	1,267	1,426	1,481	2,264	1,289	
	Count Bal	74RD48X36BL	1,267	1,426	1,481	2,264	1,289	

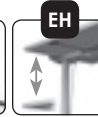
Top Size	Base	Model Number	3P	3K	3W	W1-W4	F1-F5	Round with disc-base
24 x 24	Static	74RD24D20	\$ 603	\$ 654	\$ 703	\$ 1,030	\$ 626	    Counterbalanced & Short Balanced Height Adj.    Ratchet Height Adjustable
	Ratchet	74RD24D20RA	757	808	857	1,184	788	
	Short Bal	74RD24D20BLS	1,094	1,145	1,194	1,521	1,141	
30 x 30	Static	74RD30D20	673	752	802	1,211	682	
	Ratchet	74RD30D20RA	827	906	956	1,365	843	
	Short Bal	74RD30D20BLS	1,164	1,243	1,292	1,701	1,197	
36 x 36	Static	74RD36D24	776	885	934	1,440	862	
	Short Bal	74RD36D24BLS	1,267	1,376	1,425	1,931	1,378	
	Count Bal	74RD36D24BL	1,267	1,376	1,425	1,931	1,378	
42 x 42	Static	74RD42D24	874	1,021	1,063	1,660	883	
	Short Bal	74RD42D24BLS	1,365	1,512	1,554	2,150	1,399	
	Count Bal	74RD42D24BL	1,365	1,512	1,554	2,150	1,399	
48 x 48	Static	74RD48D32	999	1,157	1,212	1,996	1,007	
	Short Bal	74RD48D32BLS	1,484	1,642	1,697	2,481	1,516	
	Count Bal	74RD48D32BL	1,484	1,642	1,697	2,481	1,516	

Top Size	Base	Model Number	3P	3K	3W	W1-W4	F1-F5	Round with TT-bases
48 x 48	Static	74RD48TT32	\$ 1,204	\$ 1,363	\$ 1,418	\$ 2,201	\$ 1,222	    Nesting TT    Electric Height Adj.
	Nesting	74RD48TT32NE	1,979	2,134	2,189	NA	2,081	
	Electric	74RD48TT32EH	3,935	4,093	4,149	4,932	4,090	
54 x 54	Static	74RD54TT32	1,364	1,586	1,615	2,463	NA	
	Nesting	74RD54TT32NE	2,135	2,353	2,382	NA	NA	
	Electric	74RD54TT32EH	4,094	4,316	4,346	5,193	NA	
60 x 60	Static	74RD60TT36	1,409	1,640	1,685	2,763	NA	
	Nesting	74RD60TT36NE	2,180	2,407	2,450	NA	NA	
	Electric	74RD60TT36EH	4,131	4,362	4,406	5,484	NA	

<b>LC</b> +90	<b>OS</b> NA	<b>CH</b> NA	<b>WM</b> NA	<b>MMLC</b> +55	<b>FT</b> X+125	<b>SH</b> X,D+65 TT+260	<b>FR</b> NA	<b>GR</b> +40	<b>CM</b> +50	<b>RC</b> NA	<b>GN</b> NA	<b>LT</b> NA
------------------	-----------------	-----------------	-----------------	--------------------	--------------------	-------------------------------	-----------------	------------------	------------------	-----------------	-----------------	-----------------

D-shaped with T-bases	Top Size	Base	Model Number	3P	3K	3W	W1-W4	F1-F5
 	24 x 36	Static	74D2436T22	\$ 616	\$ 691	\$ 761	\$ 1,052	\$ 666
		Nesting	74D2436T22NE	1,040	1,113	1,182	NA	1,130
		Ratchet	74D2436T22RA	1,022	1,097	1,167	1,458	1,092
		Crank	74D2436T22CR	1,144	1,219	1,290	1,580	1,221
		Electric	74D2436T22EH	2,048	2,123	2,194	2,484	2,170
	24 x 48	Static	74D2448T22	678	778	858	1,187	739
		Nesting	74D2448T22NE	1,101	1,199	1,277	NA	1,202
		Ratchet	74D2448T22RA	1,084	1,184	1,263	1,592	1,165
		Crank	74D2448T22CR	1,207	1,307	1,386	1,715	1,294
		Electric	74D2448T22EH	2,111	2,211	2,290	2,619	2,243
 Nesting T	24 x 60	Static	74D2460T22	741	866	954	1,321	812
		Nesting	74D2460T22NE	1,190	1,312	1,399	NA	1,302
		Ratchet	74D2460T22RA	1,147	1,272	1,360	1,727	1,238
		Crank	74D2460T22CR	1,269	1,394	1,483	1,850	1,367
		Electric	74D2460T22EH	2,173	2,298	2,387	2,754	2,316
 Ratchet Height Adjustable	24 x 72	Static	74D2472T22	803	953	1,051	1,456	885
		Nesting	74D2472T22NE	1,345	1,492	1,587	NA	1,497
		Ratchet	74D2472T22RA	1,209	1,359	1,456	1,862	1,311
		Crank	74D2472T22CR	1,332	1,482	1,579	1,984	1,440
		Electric	74D2472T22EH	2,236	2,386	2,483	2,888	2,389
 Hand Crank Height Adjustable	24 x 84	Static	74D2484T22	934	1,109	1,215	1,659	1,029
		Nesting	74D2484T22NE	1,546	1,718	1,822	NA	1,715
		Electric	74D2484T22EH	2,366	2,541	2,648	3,091	2,533
 Electric Height Adjustable	24 x 90	Static	74D2490T22	965	1,153	1,263	1,728	1,066
		Nesting	74D2490T22NE	1,577	1,761	1,869	NA	1,751
		Electric	74D2490T22EH	2,398	2,585	2,696	3,160	2,569
	24 x 96	Static	74D2496T22	997	1,197	1,312	1,797	1,102
		Nesting	74D2496T22NE	1,607	1,804	1,917	NA	1,787
		Electric	74D2496T22EH	2,429	2,629	2,744	3,230	2,606
	30 x 48	Static	74D3048T26	756	880	952	1,297	827
		Nesting	74D3048T26NE	1,177	1,299	1,369	NA	1,288
		Ratchet	74D3048T26RA	1,162	1,287	1,358	1,704	1,254
		Crank	74D3048T26CR	1,283	1,408	1,479	1,825	1,381
		Electric	74D3048T26EH	2,187	2,312	2,384	2,729	2,330
	30 x 60	Static	74D3060T26	834	990	1,066	1,444	897
		Nesting	74D3060T26NE	1,281	1,434	1,508	NA	1,385
		Ratchet	74D3060T26RA	1,240	1,396	1,472	1,850	1,323
		Crank	74D3060T26CR	1,361	1,517	1,593	1,971	1,450
		Electric	74D3060T26EH	2,266	2,422	2,498	2,875	2,400

VertiGo

- LC**  
+90
- OS**  
+35
- CH**  
NA
- WM**  
NA
- MMLC**  
+55
- FT**  
NA
- SH**  
T+130
- FR**  
NA
- GR**  
+40
- CM**  
+50
- RC**  
+55
- GN**  
+40
- LT**  
NA

Top Size	Base	Model Number	3P	3K	3W	W1-W4	F1-F5	D-shaped with T-bases
30 x 72	Static	74D3072T26	\$ 912	\$ 1,099	\$ 1,179	\$ 1,590	\$ 1,009	
	Nesting	74D3072T26NE	1,451	1,635	1,713	NA	1,619	
	Ratchet	74D3072T26RA	1,318	1,506	1,586	1,996	1,436	
	Crank	74D3072T26CR	1,439	1,626	1,707	2,117	1,563	
	Electric	74D3072T26EH	2,344	2,531	2,611	3,022	2,513	
30 x 84	Static	74D3084T26	1,058	1,277	1,361	1,804	1,172	
	Nesting	74D3084T26NE	1,668	1,882	1,965	NA	1,855	
	Electric	74D3084T26EH	2,490	2,709	2,793	3,236	2,675	
30 x 90	Static	74D3090T26	1,097	1,331	1,418	1,877	1,218	
	Nesting	74D3090T26NE-LT	1,782	NA	NA	NA	NA	
	Electric	74D3090T26EH	2,529	2,763	2,850	3,309	2,721	
30 x 96	Static	74D3096T26	1,136	1,386	1,475	1,950	1,263	
	Nesting	74D3096T26NE-LT	1,858	NA	NA	NA	NA	
	Electric	74D3096T26EH	2,568	2,818	2,906	3,382	2,767	
36 x 48	Static	74D3648T26	818	968	1,032	1,394	900	
	Nesting	74D3648T26NE	1,238	1,385	1,448	NA	1,360	
	Ratchet	74D3648T26RA	1,224	1,374	1,438	1,800	1,327	
	Crank	74D3648T26CR	1,345	1,495	1,559	1,921	1,454	
	Electric	74D3648T26EH	2,250	2,400	2,463	2,825	2,403	
36 x 60	Static	74D3660T26	912	1,099	1,162	1,551	1,009	
	Nesting	74D3660T26NE	1,479	1,663	1,725	NA	1,623	
	Ratchet	74D3660T26RA	1,318	1,506	1,569	1,958	1,436	
	Crank	74D3660T26CR	1,439	1,626	1,690	2,079	1,563	
	Electric	74D3660T26EH	2,344	2,531	2,594	2,983	2,513	
36 x 72	Static	74D3672T26	1,005	1,230	1,293	1,705	1,114	
	Nesting	74D3672T26NE	1,663	1,884	1,945	NA	1,848	
	Ratchet	74D3672T26RA	1,412	1,637	1,700	2,112	1,541	
	Crank	74D3672T26CR	1,533	1,758	1,820	2,232	1,668	
	Electric	74D3672T26EH	2,437	2,662	2,725	3,137	2,617	
36 x 84	Static	74D3684T26	1,167	1,430	1,492	1,931	1,207	
	Nest/Lightwt	74D3684T26NE-LT	1,888	NA	NA	NA	NA	
	Electric	74D3684T26EH	2,599	2,862	2,924	3,363	2,710	
36 x 90	Static	74D3690T26	1,214	1,496	1,558	2,012	1,361	
	Nest/Lightwt	74D3690T26NE-LT	1,934	NA	NA	NA	NA	
	Electric	74D3690T26EH	2,646	2,927	2,990	3,444	2,864	
36 x 96	Static	74D3696T26	1,261	1,561	1,623	2,089	1,371	
	Nest/Lightwt	74D3696T26NE-LT	1,980	NA	NA	NA	NA	
	Electric	74D3696T26EH	2,693	2,993	3,055	3,521	2,874	

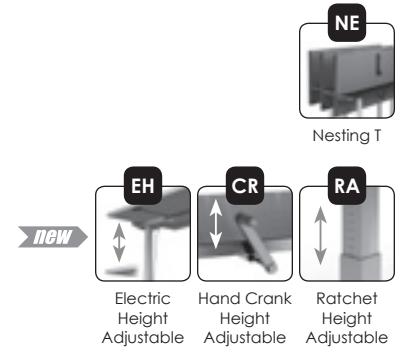



VertiGo

- LC**  
+90
- OS**  
+35
- CH**  
NA
- WM**  
NA
- MMLC**  
+55
- FT**  
NA
- SH**  
T+130
- FR**  
NA
- GR**  
+40
- CM**  
+50
- RC**  
+55
- GN**  
+40
- LT**  
NA

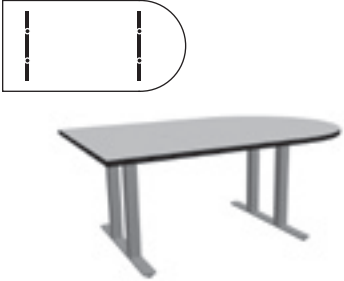
NEW

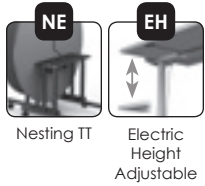
D-shaped with TT-bases	Top Size	Base	Model Number	3P	3K	3W	W1-W4	F1-F5
	42 x 60	Static	74D4260TT32	\$ 1,355	\$ 1,573	\$ 1,624	\$ 2,020	\$ 1,484
		Nesting	74D4260TT32NE	2,127	2,341	2,391	NA	2,337
		Electric	74D4260TT32EH	4,085	4,304	4,355	4,751	4,351
	42 x 72	Static	74D4272TT32	1,464	1,727	1,772	2,189	1,497
		Nesting	74D4272TT32NE	2,234	2,491	2,536	NA	2,351
		Electric	74D4272TT32EH	4,195	4,457	4,503	4,920	4,364
	42 x 84	Static	74D4284TT32	1,742	2,088	2,099	2,423	1,590
		Electric	74D4284TT32EH	4,473	4,819	4,830	5,154	4,457
	42 x 90	Static	74D4290TT32	1,804	2,175	2,181	2,508	1,611
Electric		74D4290TT32EH	4,535	4,906	4,912	5,238	4,478	
42 x 96	Static	74D4296TT32	1,866	2,262	2,263	2,592	1,754	
	Electric	74D4296TT32EH	4,597	4,993	4,994	5,323	4,621	
48 x 60	Static	74D4860TT36	1,456	1,706	1,744	2,151	1,599	
	Nesting	74D4860TT32NE	2,226	2,472	2,509	NA	2,451	
	Electric	74D4860TT36EH	4,178	4,428	4,466	4,873	4,457	
48 x 72	Static	74D4872TT36	1,581	1,881	1,910	2,328	1,633	
	Nesting	74D4872TT32NE	2,349	2,643	2,671	NA	2,484	
	Electric	74D4872TT36EH	4,303	4,603	4,631	5,050	4,491	
48 x 84	Static	74D4884TT36	1,774	2,124	2,143	2,577	1,726	
	Electric	74D4884TT36EH	4,496	4,846	4,864	5,299	4,583	
48 x 90	Static	74D4890TT36	1,837	2,212	2,226	2,754	1,768	
	Electric	74D4890TT36EH	4,558	4,933	4,947	5,476	4,626	
48 x 96	Static	74D4896TT36	1,899	2,299	2,308	2,754	1,779	
	Electric	74D4896TT36EH	4,621	5,021	5,029	5,476	4,636	

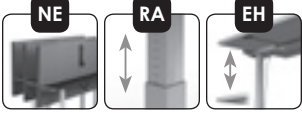

Half Round with T-bases	Top Size	Base	Model Number	3P	3K	3W	W1-W4	F1-F5
	24 x 48	Static	74HR2448T18	\$ 667	\$ 768	\$ 835	\$ 1,488	\$ 724
		Nesting	74HR2448T18NE	1,090	1,189	1,254	NA	1,187
		Ratchet	74HR2448T18RA	1,073	1,174	1,240	1,893	1,150
		Electric	74HR2448T18EH	2,100	2,201	2,267	2,920	2,228
30 x 60	Static	74HR3060T22	821	977	1,038	1,821	903	
	Nesting	74HR3060T22NE	1,240	1,394	1,454	NA	1,362	
	Ratchet	74HR3060T22RA	1,226	1,383	1,443	2,227	1,329	
	Electric	74HR3060T22EH	2,253	2,410	2,470	3,254	2,407	
	36 x 72	Static	74HR3672T26	1,004	1,229	1,274	2,182	1,119
		Nesting	74HR3672T26NE	1,607	1,827	1,872	NA	1,730
		Ratchet	74HR3672T26RA	1,411	1,635	1,680	2,589	1,545
		Electric	74HR3672T26EH	2,436	2,661	2,706	3,614	2,622

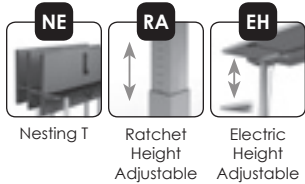

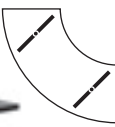

NEW

- LC  
+90
- OS  
+35
- CH  
NA
- WM  
NA
- MMLC  
+55
- FT  
NA
- SH  
T+130  
TT+260
- FR  
NA
- GR  
+40
- CM  
+50
- RC  
+55
- GN  
+40
- LT  
NA

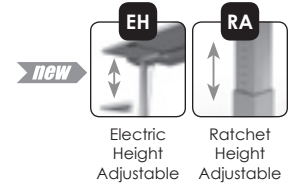
Top Size	Base	Model Number	3P	3K	3W	W1-W4	F1-F5	Crescent with T-bases
24 x 48 x 75	Static	74CS2475T22	\$ 1,223	\$ 1,541	\$ 1,489	\$ 1,825	\$ 1,590	 
	Ratchet	74CS2475T22RA	1,629	1,947	1,894	2,231	2,016	
	Electric	74CS2475T22EH	2,656	2,974	2,921	3,258	3,094	
24 x 60 x 94	Static	74CS2494T22	1,546	1,993	1,894	2,102	1,590	
	Ratchet	74CS2494T22RA	1,952	2,399	2,299	2,508	2,016	
	Electric	74CS2494T22EH	2,979	3,426	3,326	3,535	3,094	
30 x 60 x 94	Static	74CS3094T26	1,561	2,008	1,905	2,275	1,605	
	Ratchet	74CS3094T26RA	1,967	2,414	2,311	2,681	2,032	
	Electric	74CS3094T22EH	2,993	3,440	3,337	3,707	3,108	



VertiGo

Top Size	Base	Model Number	3P	3K	3W	W1-W4	F1-F5	Corner with L-bases
24 x 42	Static	74CR2442L27	\$ 989	\$ 1,157	\$ 1,216	\$ 1,873	\$ 849	 
	Crank	74CR2442L27CR	1,422	1,590	1,649	2,306	1,304	
	Electric	74CR2442L27EH	2,180	2,348	2,407	3,064	2,100	
30 x 48	Static	74CR3048L27	1,022	1,203	1,280	2,146	959	
	Crank	74CR3048L27CR	1,454	1,636	1,712	2,579	1,413	
	Electric	74CR3048L27EH	2,212	2,394	2,471	3,337	2,209	

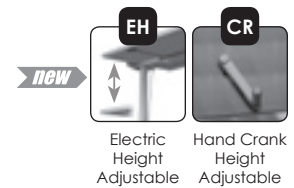

**LC**  
+90

**OS**  
+35

**CH**  
NA

**WM**  
NA

**MMLC**  
+55

**FT**  
NA

**SH**  
T,L+130

**FR**  
NA

**GR**  
+40

**CM**  
+50

**RC**  
+55

**GN**  
+40

**LT**  
NA

Trapezoid with T-bases		Top Size	Base	Model Number	3P	3K	3W	W1-W4	F1-F5
	24 x 48	Static	74TZ2448T18	\$ 659	\$ 756	\$ 822	\$ 1,268	\$ 724	
		Ratchet	74TZ2448T18RA	1,064	1,162	1,227	1,674	1,150	
		Crank	74TZ2448T18CR	1,190	1,287	1,353	1,799	1,281	
		Electric	74TZ2448T18EH	2,091	2,189	2,254	2,701	2,228	
	24 x 72	Static	74TZ2472T18	817	979	1,052	1,607	870	
		Nesting	74TZ2472T18NE	1,265	1,423	1,494	NA	1,358	
		Ratchet	74TZ2472T18RA	1,223	1,384	1,457	2,013	1,295	
		Crank	74TZ2472T18CR	1,348	1,510	1,583	2,138	1,427	
		Electric	74TZ2472T18EH	2,250	2,411	2,484	3,040	2,374	
	30 x 60	Static	74TZ3060T22	779	919	987	1,591	903	
		Nesting	74TZ3060T22NE	1,200	1,337	1,404	NA	1,362	
		Ratchet	74TZ3060T22RA	1,185	1,325	1,393	1,996	1,329	
Crank		74TZ3060T22CR	1,307	1,448	1,516	2,119	1,458		
Electric		74TZ3060T22EH	2,211	2,351	2,420	3,023	2,407		
	36 x 72	Static	74TZ3672T26	982	1,198	1,244	1,948	1,119	
		Nesting	74TZ3672T26NE	1,558	1,770	1,815	NA	1,766	
		Ratchet	74TZ3672T26RA	1,388	1,604	1,650	2,354	1,545	
		Crank	74TZ3672T26CR	1,509	1,725	1,771	2,475	1,672	
		Electric	74TZ3672T26EH	2,414	2,629	2,676	3,379	2,622	
		<i>new</i>							

Arc Segment with T-bases		Top Size	Base	Model Number	3P	3K	3W	W1-W4	F1-F5
	20 x 44	Static	74AS2044T18	\$ 692	\$ 803	\$ 835	\$ NA	\$ 655	
		Ratchet	74AS2044T18RA	1,097	1,208	1,241	NA	1,081	
		Electric	74AS2044T18EH	2,124	2,235	2,268	NA	2,159	
	24 x 51	Static	74AS2451T22	776	914	942	NA	763	
		Ratchet	74AS2451T22RA	1,181	1,320	1,348	NA	1,189	
		Electric	74AS2451T22EH	2,208	2,347	2,374	NA	2,267	
	30 x 59	Static	74AS3059T26	860	1,026	1,058	NA	918	
		Ratchet	74AS3059T26RA	1,266	1,432	1,464	NA	1,345	
		Electric	74AS3059T26EH	2,291	2,458	2,490	NA	2,422	
		36 x 67	Static	74AS3667T26	1,026	1,259	1,282	NA	1,119
			Ratchet	74AS3667T26RA	1,432	1,666	1,689	NA	1,545
			Electric	74AS3667T26EH	2,458	2,691	2,714	NA	2,622



Top Size	Base	Model Number	3P	3K	3W	W1-W4	F1-F5	Ganging Quarter Round (with T-base)
20 x 20	Ganging	QR2020GN	\$ 224	\$ 272	\$ 319	\$ NA	\$ 236	
24 x 24	Ganging	QR2424GN	233	284	344	NA	236	
30 x 30	Static, GN	74QR3030GNT26	494	572	637	NA	495	
	Ganging	QR3030GN	301	380	444	NA	292	
36 x 36	Static, GN	74QR3636GNT26	558	662	732	NA	644	
	Ganging	QR3636GN	365	469	540	NA	442	

1 base: **LC** **OS** **SH**  
NA +18 +65



Top Size	Base	Model Number	3P	3K	3W	W1-W4	F1-F5	Ganging 45° Wedge (with T-base)
20 x 20	Ganging	WG45D20GN	\$ 224	\$ 272	\$ 315	\$ NA	\$ 236	
24 x 24	Ganging	WG45D24GN	233	284	337	NA	236	
30 x 30	Ganging	WG45D30GN	301	380	432	NA	292	
36 x 36	Static, GN	74WG45D36GNT26	558	662	713	NA	644	
	Ganging	WG45D36GN	365	469	520	NA	442	

1 base: **LC** **OS** **SH**  
NA +18 +65

















Top Size	Base	Model Number	3P	3K	3W	W1-W4	F1-F5	Ganging 60° Wedge (with T-base)
20 x 20	Ganging	WG60D20GN	\$ 246	\$ 302	\$ 343	\$ NA	\$ 236	
24 x 24	Ganging	WG60D24GN	254	314	366	NA	236	
30 x 30	Static, GN	74WG60D30GNT26	515	602	655	NA	495	
	Ganging	WG60D30GN	322	410	462	NA	292	
36 x 36	Static, GN	74WG60D36GNT26	579	692	746	NA	644	
	Ganging	WG30D36GN	386	499	553	NA	442	



1 base: **LC** **OS** **SH**  
NA +18 +65





- LC**  
+90
- OS**  
+35
- CH**  
NA
- WM**  
NA
- MMLC**  
+55
- FT**  
NA
- SH**  
T+130
- FR**  
NA
- GR**  
+40
- CM**  
+50
- RC**  
+55
- GN**  
+40
- LT**  
NA







Video Wedge with T-bases	Top Size	Base	Model Number	3P	3K	3W	W1-W4	F1-F5
  <div style="display: flex; justify-content: space-around; margin-top: 20px;"> <div style="text-align: center;">  <p><b>RA</b></p>  <p>Ratchet Height Adjustable</p> </div> <div style="text-align: center;">  <p><b>EH</b></p>  <p>Electric Height Adjustable</p> </div> </div> <div style="text-align: right; margin-top: 10px;">  </div>	20 x 20 x 40	Static	74VW2040T18	\$ 649	\$ 743	\$ 803	NA	\$ 635
	Ratchet	74VW2040T18RA	1,055	1,149	1,209	NA	1,060	
	Electric	74VW2040T18EH	2,082	2,176	2,236	NA	2,139	
	24 x 24 x 48	Static	74VW2448T22	706	817	890	NA	739
	Ratchet	74VW2448T22RA	1,112	1,223	1,295	NA	1,165	
	Electric	74VW2448T22EH	2,138	2,249	2,322	NA	2,243	
	30 x 30 x 60	Static	74VW3060T26	860	1,026	1,096	NA	918
	Ratchet	74VW3060T26RA	1,266	1,432	1,503	NA	1,345	
	Electric	74VW3060T26EH	2,291	2,458	2,528	NA	2,422	
	36 x 36 x 72	Static	74VW3672T26	1,109	1,376	1,410	NA	1,119
	Ratchet	74VW3672T26RA	1,516	1,782	1,817	NA	1,545	
	Electric	74VW3672T26EH	2,541	2,808	2,842	NA	2,622	

10° Transition with T-bases	Top Size	Base	Model Number	3P	3K	3W	W1-W4	F1-F5
  <div style="display: flex; justify-content: space-around; margin-top: 20px;"> <div style="text-align: center;">  <p><b>RA</b></p>  <p>Ratchet Height Adjustable</p> </div> <div style="text-align: center;">  <p><b>EH</b></p>  <p>Electric Height Adjustable</p> </div> </div> <div style="text-align: right; margin-top: 10px;">  </div>	20 x 30	Static	74TN2030T18	\$ 553	\$ 608	\$ 674	NA	\$ 584
	Ratchet	74TN2030T18RA	959	1,014	1,080	NA	1,010	
	Electric	74TN2030T18EH	1,986	2,041	2,107	NA	2,088	
	24 x 30	Static	74TN2430T22	578	638	708	NA	629
	Ratchet	74TN2430T22RA	984	1,043	1,114	NA	1,055	
	Electric	74TN2430T22EH	2,010	2,070	2,141	NA	2,133	
	30 x 30	Static	74TN3030T26	648	730	796	NA	690
	Ratchet	74TN3030T26RA	1,054	1,136	1,202	NA	1,117	
	Electric	74TN3030T26EH	2,080	2,162	2,227	NA	2,194	
	36 x 30	Static	74TN3630T26	712	820	878	NA	736
	Ratchet	74TN3630T26RA	1,118	1,226	1,284	NA	1,162	
	Electric	74TN3630T26EH	2,144	2,252	2,309	NA	2,239	





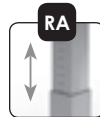
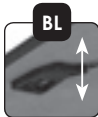

Trident with 3 Offset T-bases	Top Size	Base	Model Number	3P	3K	3W	W1-W4	F1-F5
  <div style="margin-top: 20px;"> <p>3 bases: <b>LC</b> <b>SH</b></p> <p style="margin-left: 20px;">+135 +195</p> </div>	40 x 40 x 20	Static	74TR4020TOS18(3)	\$ 1,233	\$ 1,468	\$ 1,434	\$ 1,782	\$ 1,282
	48 x 48 x 24	Static	74TR4824TOS18(3)	1,246	1,486	1,476	2,056	1,282
	60 x 60 x 30	Static	74TR6030TOS18(3)	1,434	1,748	1,725	2,490	NA

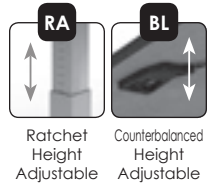
Quadrant with 4 Offset T-bases	Top Size	Base	Model Number	3P	3K	3W	W1-W4	F1-F5
  <div style="margin-top: 20px;"> <p>4 bases: <b>LC</b> <b>SH</b></p> <p style="margin-left: 20px;">+180 +260</p> </div>	60 x 60 x 20	Static	74QD6020TOS18(4)	\$ 1,673	\$ 2,005	\$ 1,994	\$ 2,845	\$ NA
	60 x 60 x 24	Static	74QD6024TOS18(4)	1,673	2,005	1,998	2,845	NA
	60 x 60 x 30	Static	74QD6030TOS18(4)	1,673	2,005	2,004	2,845	NA

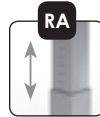

- LC**  
+90
- OS**  
+35
- CH**  
NA
- WM**  
NA
- MMLC**  
+55
- FT**  
NA
- SH**  
T+130
- FR**  
NA
- GR**  
+40
- CM**  
+50
- RC**  
NA
- GN**  
Std
- LT**  
NA

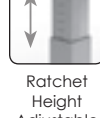
Top Size	Base	Model Number	3P	3K	3W	W1-W4	F1-F5	Bulb with X-base
30 x 30 x 20	Static	74BU3020X26	\$ 847	\$ 994	\$ 998	\$ 1,658	\$ 730	 
	Ratchet	74BU3020X26RA	996	1,143	1,147	1,807	886	
	Count Bal	74BU3020X26BL	1,212	1,359	1,363	2,023	1,113	
36 x 36 x 24	Static	74BU3624X32	967	1,156	1,151	1,938	845	
	Count Bal	74BU3624X32BL	1,331	1,520	1,515	2,302	1,227	
42 x 42 x 30	Static	74BU4230X32	1,064	1,292	1,281	2,223	964	  
	Count Bal	74BU4230X32BL	1,428	1,656	1,645	2,587	1,346	
48 x 48 x 36	Static	74BU4836X36	1,092	1,324	1,332	2,526	1,116	
	Count Bal	74BU4836X36BL	1,453	1,686	1,694	2,887	1,495	



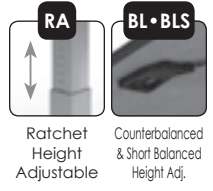

Top Size	Base	Model Number	3P	3K	3W	W1-W4	F1-F5	Squircle with X-base
24 x 24	Static	74SL24X22	\$ 747	\$ 859	\$ 886	\$ NA	\$ 616	 
	Ratchet	74SL24X22RA	896	1,009	1,035	NA	773	
	Short Bal	74SL24X22BLS	1,115	1,227	1,254	NA	1,002	
30 x 30	Static	74SL30X26	810	942	982	NA	687	  
	Ratchet	74SL30X26RA	959	1,091	1,131	NA	844	
	Short Bal	74SL30X26BLS	1,175	1,307	1,347	NA	1,071	
36 x 36	Static	74SL36X32	879	1,032	1,083	NA	852	  
	Short Bal	74SL36X32BLS	1,243	1,396	1,447	NA	1,234	
	Count Bal	74SL36X32BL	1,243	1,396	1,447	NA	1,234	
42 x 42	Static	74SL42X36	952	1,129	1,191	NA	888	
	Short Bal	74SL42X36BLS	1,314	1,491	1,552	NA	1,268	
	Count Bal	74SL42X36BL	1,314	1,491	1,552	NA	1,268	

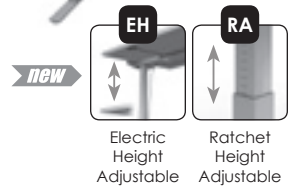

Top Size	Base	Model Number	3P	3K	3W	W1-W4	F1-F5	Table Desk with T-bases
37 x 60	Static	74TA3760T26	\$ 906	\$ 1,091	\$ 1,198	\$ 1,890	\$ 1,024	 
	Ratchet	74TA3760T26RA	1,312	1,497	1,605	2,296	1,451	
	Electric	74TA3760T26EH	2,338	2,523	2,630	3,322	2,528	



Top Size	Base	Model Number	3P	3K	3W	W1-W4	F1-F5	Table Desk with TT-bases
42 x 78	Static	74TA4278TT32	\$ 1,594	\$ 1,881	\$ 1,970	\$ 2,746	\$ 1,810	 
	Electric	74TA4278TT32EH	4,324	4,611	4,701	5,477	4,678	



<b>LC</b> +90	<b>OS</b> NA	<b>CH</b> NA	<b>WM</b> NA	<b>MMLC</b> +55	<b>FT</b> X+125	<b>SH</b> X+65 T+130	<b>FR</b> NA	<b>GR</b> +40	<b>CM</b> +50	<b>RC</b> NA	<b>GN</b> NA	<b>LT</b> NA
------------------	-----------------	-----------------	-----------------	--------------------	--------------------	----------------------------	-----------------	------------------	------------------	-----------------	-----------------	-----------------



Next features a revolutionary nesting X-base that gives your room instant flexibility. Matching T-bases let you carry a consistency throughout the installation.

### Next Base Styles



### Next Base Options

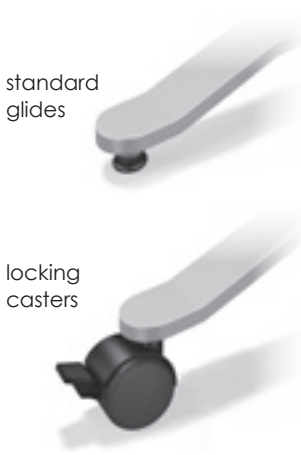

**LC Locking Casters**  
can be added to any table for \$90.

**FD Folding Bases**  
are not available on Next tables.

**NE Nesting Tables**  
priced accordingly with locking casters.

**FT Flip Tops on Nesting X**  
are listed as "Nesting X" because of the "nesting X-base." All are priced to include 3" locking casters.

**OS Offset Bases**  
are not available on Next tables.

**CH Chrome Finish**  
is not available on Next tables.

**WM Wire Management**  
Built in wire management is available on one leg for \$125.

**WMLC Wire Management Leg Covers**  
snap onto any leg and are \$45 each.

**SH Special Height**  
of can be added to any table:  
+ \$65 per column for heights > 29"  
+ \$35 per column for heights < 29"  
Special height tables larger than 36x72" must be custom quoted.

**FR Footring**  
is not available on Next series.

**PB Power Box Mounting Plate**  
is available on disc & X-bases for \$90.

Next

## The Next “Nesting X-base”

The Next series has the unique ability to nest X-base tables with Flip Tops. These tables are priced and listed as “nesting” tables with locking casters.



## Next Height Adjustable Options

**NU Pneumatic** is available on X-bases for \$350 per table.

**AH Spring Clip** is available on X-bases for \$125 and on T-bases for \$250 per table.

## Next Top Shapes



rectangle  
p.174



square  
p.175



round  
p.175

## Next Top Options

**RC 3” Radius Corners** can be added to any table for \$55.

**LT Lightweight Tops** can be added to any square or rectangular table for \$115.

**GR Grommets** can be added to any table for \$40 each. To see specific locations, see page 203.

**CM Cable Manager** can be added to any table for \$50 each. To see specific locations, see page 203.

**GN Ganging Brackets** can be added to most table shapes for \$40.

## Next Edge Options



(correspond with 5 columns of pricing)



3mm PVC		3mm PVC		3mm Wood		1.25” Wood		Rigid Thermofoil	
	<b>3P</b> Flat		<b>3K</b> Knife		<b>3W</b> Flat		<b>W1</b> Bullnose		<b>F1</b> Waterfall
	<b>3P</b> Reed						<b>W2</b> Square		<b>F2</b> Flat
							<b>W3</b> Fluted		<b>F3</b> Bevel
							<b>W4</b> Reverse Bevel		<b>F4</b> Radius
									<b>F5</b> Slope



Rectangular with T-bases	Top Size	Base	Model Number	3P	3K	3W	W1-W4	F1-F5
	24 x 36	Static	88TC2436T22	\$ 799	\$ 856	\$ 952	\$ 1,111	\$ 907
		Nesting	88TC2436T22NE	1,219	1,275	1,369	NA	1,366
	24 x 48	Static	88TC2448T22	845	920	1,030	1,219	924
		Nesting	88TC2448T22NE	1,291	1,365	1,473	NA	1,412
	24 x 60	Static	88TC2460T22	866	950	1,081	1,330	988
		Nesting	88TC2460T22NE	1,368	1,450	1,579	NA	1,534
	24 x 72	Static	88TC2472T22	906	1,005	1,152	1,438	1,022
		Nesting	88TC2472T22NE	1,585	1,683	1,827	NA	1,778
	24 x 84	Static	88TC2484T22	1,051	1,181	1,333	1,618	1,258
		Nesting	88TC2484T22NE	1,660	1,788	1,937	NA	1,939
 Nesting T	24 x 90	Static	88TC2490T22	1,097	1,245	1,397	1,672	1,268
		Nesting	88TC2490T22NE	1,706	1,851	2,000	NA	1,950
	24 x 96	Static	88TC2496T22	1,097	1,245	1,411	1,726	1,279
		Nesting	88TC2496T22NE	1,706	1,851	2,014	NA	1,960
	30 x 36	Static	88TC3036T26	844	914	1,014	1,183	962
		Nesting	88TC3036T26NE	1,263	1,332	1,430	NA	1,420
	30 x 48	Static	88TC3048T26	900	993	1,104	1,307	973
		Nesting	88TC3048T26NE	1,346	1,437	1,545	NA	1,459
	30 x 60	Static	88TC3060T26	918	1,018	1,151	1,426	1,132
		Nesting	88TC3060T26NE	1,420	1,518	1,648	NA	1,675
	30 x 72	Static	88TC3072T26	963	1,081	1,228	1,545	1,208
		Nesting	88TC3072T26NE	1,641	1,757	1,901	NA	1,961
	30 x 84	Static	88TC3084T26	1,139	1,300	1,443	1,733	1,290
		Nesting	88TC3084T26NE	1,747	1,905	2,045	NA	1,971
	30 x 90	Static	88TC3090T26	1,196	1,380	1,519	1,794	1,311
		Nest/Lightwt	88TC3090T26NE-LT	1,916	NA	2,245	NA	NA
	30 x 96	Static	88TC3096T26	1,196	1,380	1,533	1,852	1,322
		Nest/Lightwt	88TC3096T26NE-LT	1,916	NA	2,258	NA	NA
	36 x 48	Static	88TC3648T26	945	1,056	1,167	1,380	1,022
		Nesting	88TC3648T26NE	1,549	1,658	1,767	NA	1,701
	36 x 60	Static	88TC3660T26	1,013	1,151	1,269	1,510	1,229
		Nesting	88TC3660T26NE	1,671	1,806	1,922	NA	1,961
	36 x 72	Static	88TC3672T26	1,056	1,211	1,344	1,641	1,350
		Nesting	88TC3672T26NE	1,733	1,885	2,015	NA	2,100
	36 x 84	Static	88TC3684T26	1,217	1,409	1,542	1,840	1,443
		Nest/Lightwt	88TC3684T26NE-LT	1,937	NA	2,267	NA	NA
	36 x 90	Static	88TC3690T26	1,284	1,503	1,630	1,906	1,453
		Nest/Lightwt	88TC3690T26NE-LT	2,003	NA	2,353	NA	NA
	36 x 96	Static	88TC3696T26	1,284	1,503	1,644	1,971	1,458
		Nest/Lightwt	88TC3696T26NE-LT	2,003	NA	2,367	NA	NA



Next

- LC**  
+90
- OS**  
+35
- CH**  
NA
- WM**  
+125
- WMLC**  
+45
- SH**  
T+130
- FR**  
NA
- PB**  
NA
- GR**  
+40
- CM**  
+50
- RC**  
+55
- GN**  
+40
- LT**  
+115
- AH**  
T+250
- NU**  
NA

Top Size	Base	Model Number	3P	3K	3W	W1-W4	F1-F5	Square with X-base
24 x 24	Static	88SQ2424X22	\$ 493	\$ 532	\$ 614	\$ 744	\$ 544	   Flip Top + Nesting X
	Nesting X	88SQ2424X22NE	709	748	830	960	770	
30 x 30	Static	88SQ3030X26	567	626	720	877	623	
	Nesting X	88SQ3030X26NE	783	842	936	1,093	850	
36 x 36	Static	88SQ3636X32	648	732	836	1,020	793	
	Nesting X	88SQ3636X32NE	864	948	1,051	1,236	1,019	

Top Size	Base	Model Number	3P	3K	3W	W1-W4	F1-F5	Square with TT-bases
48 x 48	Static	88SQ4848TT32	\$ 1,170	\$ 1,317	\$ 1,428	\$ 1,660	\$ 1,216	   Nesting TT
	Nesting	88SQ4848TT32NE	1,945	2,089	2,199	NA	2,075	

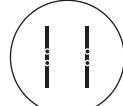
Top Size	Base	Model Number	3P	3K	3W	W1-W4	F1-F5	Round with X-base
24 x 24	Static	88RD24X22	\$ 525	\$ 576	\$ 625	\$ 951	\$ 544	   Flip Top + Nesting X
	Nesting X	88RD24X22NE	741	792	841	1,167	770	
30 x 30	Static	88RD30X26	617	696	746	1,155	623	
	Nesting X	88RD30X26NE	833	912	961	1,370	850	
36 x 36	Static	88RD36X30	705	814	863	1,369	788	
	Nesting X	88RD36X30NE	921	1,030	1,079	1,585	1,015	
42 x 42	Static	88RD42X32	808	955	997	1,593	814	
	Nesting X	88RD42X32NE	1,023	1,171	1,213	1,809	1,040	

Top Size	Base	Model Number	3P	3K	3W	W1-W4	F1-F5	Round with TT-base
48 x 48	Static	88RD48TT32	\$ 1,198	\$ 1,357	\$ 1,412	\$ 2,195	\$ 1,216	   Nesting TT
	Nesting	88RD48TT32NE	1,973	2,129	2,183	NA	2,075	
54 x 54	Static	88RD54TT32	1,358	1,580	1,609	2,457	NA	
	Nesting	88RD54TT32NE	2,130	2,348	2,376	NA	NA	
60 x 60	Static	88RD60TT32	1,380	1,611	1,655	2,734	NA	
	Nesting	88RD60TT32NE	2,152	2,378	2,422	NA	NA	

<b>LC</b> +90	<b>OS</b> NA	<b>CH</b> NA	<b>WM</b> +125	<b>WMLC</b> +45	<b>SH</b> X+65 TT+260	<b>FR</b> NA	<b>PB</b> +90	<b>GR</b> +40	<b>CM</b> +50	<b>RC</b> +55	<b>GN</b> +40	<b>LT</b> +115	<b>AH</b> X+125	<b>NU</b> X+350
------------------	-----------------	-----------------	-------------------	--------------------	-----------------------------	-----------------	------------------	------------------	------------------	------------------	------------------	-------------------	--------------------	--------------------

Next



**new**



A quality height adjustable table that doesn't break the bank. Surge height adjustable tables are sleek, stylish, and versatile. With both static and height adjustable options in a variety of top shapes and sizes, there is a Surge table to fit your needs.

### Surge Base Styles

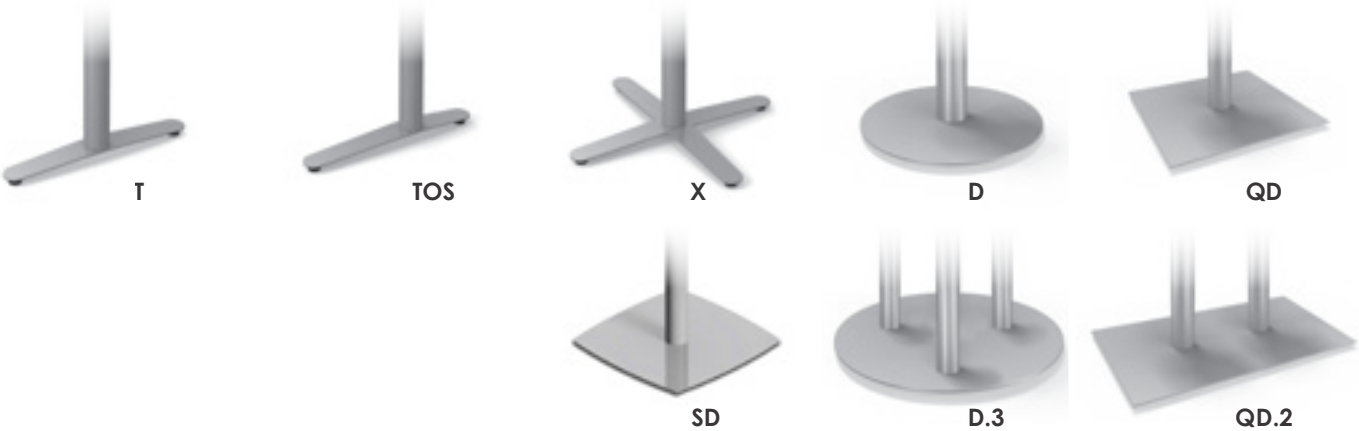

### Surge Base Options

standard glides



locking casters



- LC** **Locking Casters**  
can be added to any table for \$90.
- FD** **Folding Bases**  
priced accordingly with standard glides.
- NE** **Nesting Tables**  
priced accordingly with locking casters.
- FT** **Flip Tops**  
available on disc and X-based tables for \$125. Not available on counter-balanced tables.
- OS** **Offset Bases**  
available for \$35.
- CH** **Chrome Finish**  
is not available on Surge tables.
- WM** **Wire Management**  
Built in wire management is not available on Surge tables.
- WMLC** **Wire Management Leg Covers**  
snap onto any leg and are \$45 each.
- SH** **Special Height**  
of can be added to any table:  
+ \$65 per column for heights > 29"  
+ \$35 per column for heights < 29"  
Special height tables larger than 36x72" must be custom quoted.
- FR** **Footring**  
is not available on Surge tables.
- PB** **Power Box Mounting Plate**  
is available on disc & X-bases for \$90.



## Surge Base Finishes

**Static, folding, & nesting tables** are available in any standard TableX base finish.

**Counter-balanced, short balanced, and electric tables** are available in two finishes:

- 02 Black
- 37 Satin Silver

## Surge Top Shapes



rectangle  
p.180-181



boat  
p.182



racetrack  
p.182



elliptical  
p.182



squircle  
p.183



square  
p.184



round  
p.185



D-shaped  
p.186-187



half round  
p.187



crescent  
p.187



trapezoid  
p.187



arc segment  
p.188



quarter round  
p.188



wedges  
p.188



video wedge  
p.189



10° transition  
p.189



bulb  
p.189



table desk  
p.189

## Surge Top Options

**RC 3" Radius Corners** can be added to any table for \$55.

**GN Ganging Brackets** can be added to most table shapes for \$40.

**LT Lightweight Tops** can be added to any square or rectangular table for \$115. This is a great option when specifying folding tables.

**GR Grommets** can be added to any table for \$40 each. To see specific locations, see page 157.

**CM Cable Manager** can be added to any table for \$50 each. To see specific locations, see page 157.

## Surge Edge Options

(correspond with 5 columns of pricing)

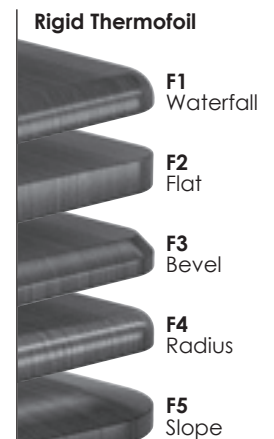
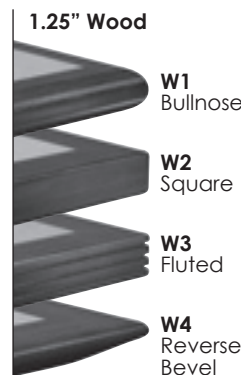
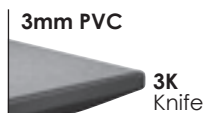
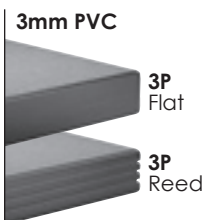

## electric height adjustable T-bases

Electric height adjustability gives you the ability to go from sitting to standing height at the push of a button. With a weight capacity of 225 lbs. per table, Surge is strong enough to work in many different applications.

The standard memory keypad will remember your four favorite heights.

Want to use Surge on the go? Simply add 2" to each vertical measurement to account for locking casters.

**To specify:**  
All available electric models are priced in the following pages. They are denoted by the "EH" at the end of the model number.

**Example:**  
99TC2460T22EH-3P  
24x60" **electric height** table  
**\$1,798** List Price

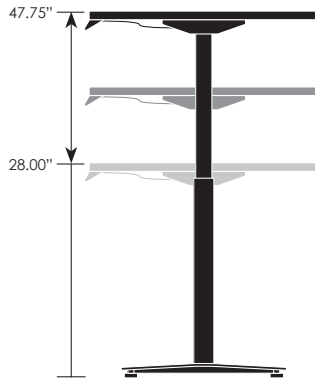

T-bases



standard memory keypad



Surge

## counter balanced & short balanced height adjustable disc & X-bases

Counter balanced tables go from seated-to-standing height, while the short balanced goes from coffee-to-seated height. Available on tables using single column disc or X-bases, these tables are easy to adjust. Simply squeeze the small handle underneath and gently move the top to your desired height. It's that easy.

Want to use Surge on the go? Simply add 2" to each vertical measurement to account for the added height of locking casters.

**To specify:**

All available counter balanced models are priced in the following pages. They are denoted by the "BL" or "BLS" (for short balanced) at the end of the model number.

**Example:**

99RD36X30BL-3P  
36" round **counter balanced** table  
**\$1370** List Price

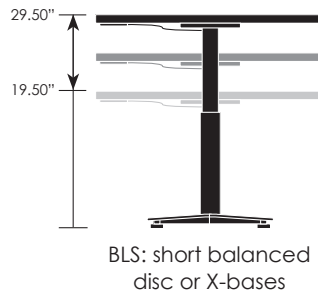
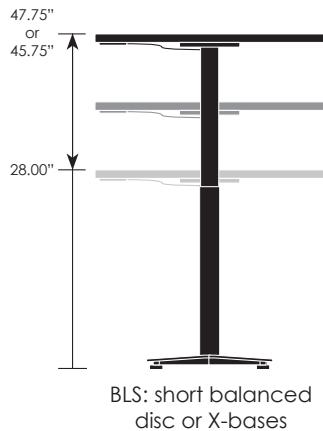
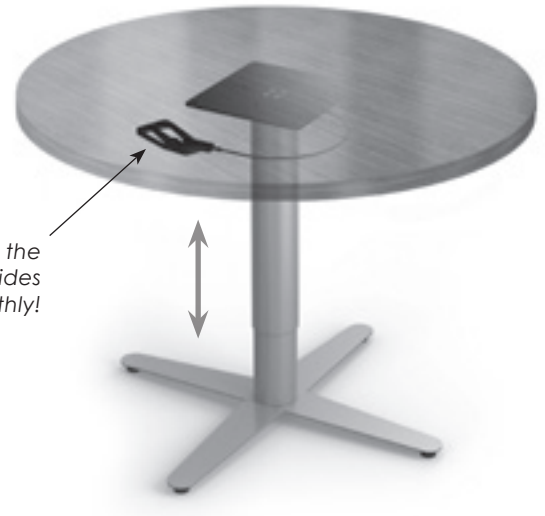

**Ranges:**

Smaller Surge tables using smaller bases have a 17.75" range, while the larger tables using larger bases have an extended range of 19.75". See the list below for ranges of used on specific top shapes and sizes. All counter-balanced tables have a starting height of 28".

square	range	max ht.	round	range	max ht.
36" SQ	19.75"	47.75"	36" RD-X	17.75"	45.75"
42" SQ			36" BU		
			36" RD-D	19.75"	47.75"
			42" RD		
			48" RD		

NEW

Rectangular with T-bases	Top Size	Base	Model Number	3P	3K	3W	W1-W4	F1-F5
  <div style="display: flex; justify-content: space-around; margin-top: 10px;"> <div style="text-align: center;">  <p>FD Folding T</p> </div> <div style="text-align: center;">  <p>NE Nesting T</p> </div> <div style="text-align: center;">  <p>EH Electric Height Adjustable</p> </div> </div>	24 x 36	Static	99TC2436T22	\$ 575	\$ 632	\$ 728	\$ 887	\$ 672
	Nesting	99TC2436T22NE	1,000	1,055	1,150	NA	1,136	
	Electric	99TC2436T22EH	1,652	1,709	1,805	1,965	1,803	
	24 x 48	Static	99TC2448T22	621	696	806	995	689
	Folding	99TC2448T22FD	874	949	1,059	1,248	955	
	Nesting	99TC2448T22NE	1,072	1,146	1,253	NA	1,182	
	Electric	99TC2448T22EH	1,698	1,773	1,883	2,072	1,821	
	24 x 60	Static	99TC2460T22	642	726	857	1,107	754
	Folding	99TC2460T22FD	906	989	1,121	1,370	1,030	
	Nesting	99TC2460T22NE	1,149	1,231	1,360	NA	1,304	
	Electric	99TC2460T22EH	1,720	1,803	1,934	2,184	1,885	
	24 x 72	Static	99TC2472T22	682	781	928	1,214	787
Folding	99TC2472T22FD	945	1,045	1,192	1,478	1,063		
Nesting	99TC2472T22NE	1,366	1,463	1,607	NA	1,548		
Electric	99TC2472T22EH	1,759	1,859	2,006	2,292	1,918		
24 x 84	Static	99TC2484T22	827	957	1,109	1,394	1,023	
Folding	99TC2484T22FD	1,022	1,152	1,304	1,589	1,228		
Nesting	99TC2484T22NE	1,441	1,569	1,718	NA	1,709		
24 x 90	Static	99TC2490T22	873	1,021	1,173	1,448	1,033	
Folding	99TC2490T22FD	1,068	1,217	1,368	1,643	1,238		
Nesting	99TC2490T22NE	1,486	1,632	1,781	NA	1,719		
24 x 96	Static	99TC2496T22	873	1,021	1,187	1,502	1,044	
Folding	99TC2496T22FD	1,068	1,217	1,382	1,697	1,249		
Nesting	99TC2496T22NE	1,486	1,632	1,794	NA	1,730		
30 x 36	Static	99TC3036T26	615	685	785	954	722	
Nesting	99TC3036T26NE	1,039	1,108	1,205	NA	1,185		
Electric	99TC3036T26EH	1,692	1,762	1,862	2,032	1,853		
30 x 48	Static	99TC3048T26	672	765	875	1,078	732	
Folding	99TC3048T26FD	925	1,018	1,128	1,331	998		
Nesting	99TC3048T26NE	1,122	1,213	1,321	NA	1,224		
Electric	99TC3048T26EH	1,749	1,842	1,952	2,155	1,863		
30 x 60	Static	99TC3060T26	689	789	922	1,197	892	
Folding	99TC3060T26FD	953	1,053	1,186	1,460	1,169		
Nesting	99TC3060T26NE	1,195	1,293	1,423	NA	1,439		
Electric	99TC3060T26EH	1,767	1,867	1,999	2,274	2,023		
30 x 72	Static	99TC3072T26	734	852	999	1,316	968	
Folding	99TC3072T26FD	997	1,115	1,262	1,580	1,244		
Nesting	99TC3072T26NE	1,416	1,532	1,676	NA	1,725		
Electric	99TC3072T26EH	1,811	1,929	2,076	2,394	2,099		

Surge

- LC**  
+90
- OS**  
+35
- CH**  
NA
- WM**  
NA
- WMLC**  
+45
- FT**  
NA
- SH**  
T+130
- FR**  
NA
- PB**  
NA
- GR**  
+40
- CM**  
+50
- RC**  
+55
- GN**  
+40
- LT**  
+115

Top Size	Base	Model Number	3P	3K	3W	W1-W4	F1-F5	Rectangular with T-bases	<b>NEW</b>
30 x 84	Static	99TC3084T26	\$ 910	\$ 1,071	\$ 1,214	\$ 1,504	\$ 1,050		
	Folding	99TC3084T26FD	1,105	1,267	1,409	1,699	1,255		
	Nesting	99TC3084T26NE	1,523	1,681	1,820	NA	1,735		
30 x 90	Static	99TC3090T26	967	1,151	1,290	1,565	1,071		
	Folding	99TC3090T26FD	1,163	1,347	1,486	1,760	1,276		
	Nest/Lightwt	99TC3090T26NE-LT	1,692	NA	2,020	NA	NA		
30 x 96	Static	99TC3096T26	967	1,151	1,304	1,623	1,081		
	Folding	99TC3096T26FD	1,163	1,347	1,499	1,818	1,287		
	Nest/Lightwt	99TC3084T26NE-LT	1,692	NA	2,034	NA	NA		
36 x 48	Static	99TC3648T26	716	827	938	1,151	782		
	Folding	99TC3648T26FD	970	1,081	1,191	1,404	1,048		
	Nesting	99TC3648T26NE	1,325	1,434	1,542	NA	1,465		
	Electric	99TC3648T26EH	1,794	1,905	2,015	2,228	1,913		
36 x 60	Static	99TC3660T26	784	922	1,040	1,282	989		
	Folding	99TC3660T26FD	1,048	1,186	1,304	1,545	1,265		
	Nesting	99TC3660T26NE	1,446	1,582	1,698	NA	1,725		
	Electric	99TC3660T26EH	1,862	2,000	2,118	2,359	2,120		
36 x 72	Static	99TC3672T26	827	982	1,115	1,412	1,110		
	Folding	99TC3672T26FD	1,090	1,246	1,379	1,676	1,386		
	Nesting	99TC3672T26NE	1,508	1,660	1,791	NA	1,864		
	Electric	99TC3672T26EH	1,904	2,060	2,193	2,490	2,241		
36 x 84	Static	99TC3684T26	988	1,181	1,313	1,611	1,202		
	Folding	99TC3684T26FD	1,183	1,376	1,509	1,807	1,407		
	Nest/Lightwt	99TC3684T26NE-LT	1,712	NA	2,043	NA	NA		
36 x 90	Static	99TC3690T26	1,055	1,274	1,401	1,677	1,213		
	Folding	99TC3690T26FD	1,250	1,470	1,596	1,872	1,418		
	Nest/Lightwt	99TC3690T26NE-LT	1,778	NA	2,128	NA	NA		
36 x 96	Static	99TC3696T26	1,055	1,274	1,415	1,742	1,218		
	Folding	99TC3696T26FD	1,250	1,470	1,610	1,938	1,423		
	Nest/Lightwt	99TC3696T26NE-LT	1,778	NA	2,142	NA	NA		

Top Size	Base	Model Number	3P	3K	3W	W1-W4	F1-F5	Rectangle with 2-column disc base	<b>NEW</b>
24 x 36	Static	99TC2436QD2032.2	\$ 814	\$ 871	\$ 967	\$ 1,126	\$ 923		
24 x 48	Static	99TC2448QD2032.2	860	935	1,045	1,234	940		
30 x 36	Static	99TC3036QD2032.2	848	918	1,018	1,188	967		
30 x 48	Static	99TC3048QD2032.2	905	998	1,108	1,311	977		
36 x 48	Static	99TC3648QD2032.2	950	1,061	1,171	1,384	1,027		

- LC**  
+90
- OS**  
+35
- CH**  
NA
- WM**  
NA
- WMLC**  
+45
- FT**  
NA
- SH**  
T+130
- FR**  
NA
- PB**  
NA
- GR**  
+40
- CM**  
+50
- RC**  
+55
- GN**  
+40
- LT**  
+115

NEW

Boat-shaped with T-bases	Top Size	Base	Model Number	3P	3K	3W	W1-W4	F1-F5
	30 x 42 x 84	Static	99BT3084T26	\$ 1,271	\$ 1,576	\$ 1,596	\$ 2,316	\$ 1,337
	30 x 42 x 90	Static	99BT3090T26	1,379	1,728	1,729	2,416	1,362
	30 x 42 x 96	Static	99BT3096T26	1,379	1,728	1,743	2,512	1,375

NEW

Racetrack with T-bases	Top Size	Base	Model Number	3P	3K	3W	W1-W4	F1-F5
	36 x 60	Static	99RT3672T26	\$ 912	\$ 1,101	\$ 1,145	\$ 1,743	\$ 1,095
		Nesting	99RT3672T26NE	1,517	1,703	1,746	NA	1,772
		Electric	99RT3672T26EH	1,989	2,179	2,223	2,821	2,226
	36 x 72	Static	99RT3672T26	1,003	1,228	1,273	1,924	1,240
		Folding	99RT3672T26FD	1,266	1,492	1,536	2,188	1,517
		Nesting	99RT3672T26NE	1,661	1,882	1,925	NA	1,971
		Electric	99RT3672T26EH	2,080	2,306	2,350	3,002	2,371
	36 x 84	Static	99RT3684T26	1,165	1,429	1,473	2,177	1,337
		Folding	99RT3684T26FD	1,361	1,624	1,668	2,372	1,542
	36 x 90	Static	99RT3690T26	1,288	1,600	1,621	2,269	1,350
		Folding	99RT3690T26FD	1,483	1,795	1,816	2,465	1,555
	36 x 96	Static	99RT3696T26	1,288	1,600	1,635	2,358	1,356
Folding		99RT3696T26FD	1,483	1,795	1,830	2,553	1,561	

**FD**  
Folding T

**NE**  
Nesting T



**EH**  
Electric Height Adjustable



NEW

Elliptical with T-bases	Top Size	Base	Model Number	3P	3K	3W	W1-W4	F1-F5
	30 x 54	Static	99EL3054T22	\$ 789	\$ 932	\$ 977	\$ 1,534	\$ 862
		Electric	99EL3054T22EH	1,867	2,009	2,055	2,611	1,993
	30 x 60	Static	99EL3060T22	827	984	1,030	1,618	886
		Electric	99EL3060T22EH	1,904	2,062	2,107	2,696	2,017
	36 x 60	Static	99EL3660T26	912	1,101	1,134	1,743	989
		Electric	99EL3660T26EH	1,989	2,179	2,211	2,821	2,120
	36 x 72	Static	99EL3672T26	1,003	1,228	1,255	1,924	1,110
		Electric	99EL3672T26EH	2,080	2,306	2,332	3,002	2,241
	36 x 84	Static	99EL3684T26	1,165	1,429	1,449	2,177	1,202
	36 x 90	Static	99EL3690T26	1,288	1,600	1,594	2,269	1,249
	36 x 96	Static	99EL3696T26	1,288	1,600	1,605	2,358	1,274



**EH**  
Electric Height Adjustable

- LC**  
+90
- OS**  
+35
- CH**  
NA
- WM**  
NA
- WMLC**  
+45
- FT**  
NA
- SH**  
T+130
- FR**  
NA
- PB**  
NA
- GR**  
+40
- CM**  
+50
- RC**  
+55
- GN**  
+40
- LT**  
+115

Top Size	Base	Model Number	3P	3K	3W	W1-W4	F1-F5	Squircle with X-base	<i>new</i>
24 x 24	Static	99SL24X22	\$ 645	\$ 758	\$ 784	NA	\$ 509	   <p>Counterbalanced &amp; Short Balanced Height Adj.</p>	
	Short Bal	99SL24X22BLS	1,071	1,184	1,210	NA	957		
30 x 30	Static	99SL30X22	694	826	865	NA	565		
	Short Bal	99SL30X22BLS	1,120	1,252	1,291	NA	1,012		
36 x 36	Static	99SL36X26	751	904	955	NA	717		
	Short Bal	99SL36X26BLS	1,177	1,330	1,381	NA	1,165		
	Count Bal	99SL36X26BL	1,177	1,330	1,381	NA	1,165		
42 x 42	Static	99SL42X30	873	1,050	1,111	NA	805		
	Short Bal	99SL42X30BLS	1,541	1,718	1,779	NA	1,506		
	Count Bal	99SL42X30BL	1,541	1,718	1,779	NA	1,506		

Top Size	Base	MoSDel Number	3P	3K	3W	W1-W4	F1-F5	Squircle with disc base	<i>new</i>
24 x 24	Static	99SL24SD16	\$ 757	\$ 869	\$ 895	NA	\$ 626	   <p>Counterbalanced &amp; Short Balanced Height Adj.</p>	
	Short Bal	99SL24SD16BLS	1,178	1,290	1,317	NA	1,068		
30 x 30	Static	99SL30SD16	805	937	977	NA	682		
	Short Bal	99SL30SD16BLS	1,226	1,358	1,398	NA	1,124		
36 x 36	Static	99SL36SD20	889	1,042	1,093	NA	862		
	Short Bal	99SL36SD20BLS	1,531	1,685	1,736	NA	1,537		
	Count Bal	99SL36SD20BL	1,531	1,685	1,736	NA	1,537		
42 x 42	Static	99SL42SD26	1,045	1,222	1,283	NA	986		
	Short Bal	99SL42SD26BLS	1,680	1,857	1,918	NA	1,652		
	Count Bal	99SL42SD26BL	1,680	1,857	1,918	NA	1,652		



NEW

Square with X-base	Top Size	Base	Model Number	3P	3K	3W	W1-W4	F1-F5
 	24 x 24	Static	99SQ2424X22	\$ 460	\$ 499	\$ 581	\$ 711	\$ 509
		Short Bal	99SQ2424X22BLS	886	925	1,007	1,137	957
	30 x 30	Static	99SQ3030X26	514	573	668	825	568
		Short Bal	99SQ3030X26BLS	941	1,000	1,094	1,251	1,015
	36 x 36	Static	99SQ3636X30	640	724	827	1,011	784
		Short Bal	99SQ3636X30BLS	1,308	1,392	1,495	1,680	1,485
Count Bal		99SQ3636X30BL	1,308	1,392	1,495	1,680	1,485	
42 x 42	Static	99SQ4242X34	729	842	951	1,162	821	
	Short Bal	99SQ4242X34BLS	1,397	1,510	1,619	1,830	1,523	
	Count Bal	99SQ4242X34BL	1,397	1,510	1,619	1,830	1,523	



Counterbalanced & Short Balanced Height Adj.

NEW

Square with square disc base	Top Size	Base	Model Number	3P	3K	3W	W1-W4	F1-F5
 	24 x 24	Static	99SQ2424QD16	\$ 572	\$ 610	\$ 692	\$ 822	\$ 626
		Short Bal	99SQ2424QD16BLS	993	1,031	1,113	1,243	1,068
	30 x 30	Static	99SQ3030QD16	623	682	776	934	682
		Short Bal	99SQ3030QD16BLS	1,044	1,103	1,198	1,355	1,124
	36 x 36	Static	99SQ3636QD20	715	799	902	1,086	862
		Short Bal	99SQ3636QD20BLS	1,358	1,441	1,545	1,729	1,537
Count Bal		99SQ3636QD20BL	1,358	1,441	1,545	1,729	1,537	
42 x 42	Static	99SQ4242QD26	886	999	1,108	1,318	986	
	Short Bal	99SQ4242QD26BLS	1,520	1,633	1,742	1,953	1,652	
	Count Bal	99SQ4242QD26BL	1,520	1,633	1,742	1,953	1,652	





Counterbalanced & Short Balanced Height Adj.

Surge



- LC  
+90
- OS  
NA
- CH  
NA
- WM  
NA
- WMLC  
+45
- FT  
X+125
- SH  
+65
- FR  
NA
- PB  
+90
- GR  
+40
- CM  
+50
- RC  
+55
- GN  
+40
- LT  
+115



Top Size	Base	Model Number	3P	3K	3W	W1-W4	F1-F5	Round with X-base	NEW
24 x 24	Static	99RD24X22	\$ 492	\$ 543	\$ 592	\$ 918	\$ 509	 	
	Short Bal	99RD24X22BLS	918	969	1,018	1,345	957		
30 x 30	Static	99RD30X26	565	644	693	1,102	568		
	Short Bal	99RD30X26BLS	991	1,070	1,119	1,528	1,015		
36 x 36	Static	99RD36X30	702	810	859	1,366	784		
	Short Bal	99RD36X30BLS	1,370	1,478	1,527	2,034	1,485		
	Count Bal	99RD36X30BL	1,370	1,478	1,527	2,034	1,485		
42 x 42	Static	99RD42X30	799	947	988	1,585	805		
	Short Bal	99RD42X30BLS	1,467	1,615	1,656	2,253	1,506		
	Count Bal	99RD42X30BL	1,467	1,615	1,656	2,253	1,506		
48 x 48	Static	99RD48X34	842	1,001	1,056	1,839	842		
	Short Bal	99RD48X34BLS	1,510	1,669	1,724	2,507	1,544		
	Count Bal	99RD48X34BL	1,510	1,669	1,724	2,507	1,544		



Counterbalanced & Short Balanced Height Adj.

Top Size	Base	Model Number	3P	3K	3W	W1-W4	F1-F5	Round with disc base	NEW
24 x 24	Static	99RD24D20	\$ 603	\$ 654	\$ 703	\$1,030	\$ 626	 	
	Short Bal	99RD24D20BLS	1,025	1,076	1,124	1,451	1,068		
30 x 30	Static	99RD30D20	673	752	802	1,211	682		
	Short Bal	99RD30D20BLS	1,094	1,173	1,223	1,632	1,124		
36 x 36	Static	99RD36D20	747	855	904	1,411	831		
	Short Bal	99RD36D20BLS	1,168	1,277	1,326	1,832	1,274		
	Count Bal	99RD36D20BL	1,168	1,277	1,326	1,832	1,274		
42 x 42	Static	99RD42D24	874	1,021	1,063	1,660	883		
	Short Bal	99RD42D24BLS	1,517	1,664	1,706	2,302	1,558		
	Count Bal	99RD42D24BL	1,517	1,664	1,706	2,302	1,558		
48 x 48	Static	99RD48D32	999	1,157	1,212	1,996	1,007		
	Short Bal	99RD48D32BLS	1,633	1,792	1,847	2,630	1,673		
	Count Bal	99RD48D32BL	1,633	1,792	1,847	2,630	1,673		

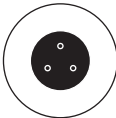

Counterbalanced & Short Balanced Height Adj.

Top Size	Base	Model Number	3P	3K	3W	W1-W4	F1-F5	Round with 3-column disc base	NEW
54 x 54	Static	99RD54D24.3	\$1,256	\$1,478	\$1,507	\$2,355	NA	 	
60 x 60	Static	99RD60D32.3	1,371	1,602	1,646	2,725	NA		

3 columns: SH +195

- LC**  
+90
- OS**  
NA
- CH**  
NA
- WM**  
NA
- WMLC**  
+45
- FT**  
X+125
- SH**  
+65
- FR**  
NA
- PB**  
+90
- GR**  
+40
- CM**  
+50
- RC**  
NA
- GN**  
NA
- LT**  
NA

**NEW**

D-shaped with T-bases	Top Size	Base	Model Number	3P	3K	3W	W1-W4	F1-F5
 	24 x 36	Static	99D2436T22	\$ 621	\$ 696	\$ 766	\$ 1,057	\$ 671
		Nesting	99D2436T22NE	1,045	1,118	1,187	NA	1,135
		Electric	99D2436T22EH	1,698	1,773	1,843	2,134	1,802
	24 x 48	Static	99D2448T22	683	783	863	1,191	744
		Nesting	99D2448T22NE	1,106	1,204	1,282	NA	1,206
		Electric	99D2448T22EH	1,761	1,861	1,940	2,269	1,875
	24 x 60	Static	99D2460T22	746	871	959	1,326	817
		Nesting	99D2460T22NE	1,194	1,317	1,403	NA	1,306
		Electric	99D2460T22EH	1,823	1,948	2,036	2,403	1,948
24 x 72	Static	99D2472T22	808	958	1,055	1,461	890	
	Nesting	99D2472T22NE	1,350	1,497	1,592	NA	1,502	
	Electric	99D2472T22EH	1,886	2,035	2,133	2,538	2,021	
24 x 84	Static	99D2484T22	939	1,114	1,220	1,663	1,034	
	Nesting	99D2484T22NE	1,551	1,722	1,827	NA	1,720	
24 x 90	Static	99D2490T22	970	1,158	1,268	1,733	1,071	
	Nesting	99D2490T22NE	1,581	1,765	1,874	NA	1,756	
24 x 96	Static	99D2496T22	1,001	1,201	1,316	1,802	1,107	
	Nesting	99D2496T22NE	1,612	1,808	1,921	NA	1,792	
30 x 48	Static	99D3048T26	751	876	948	1,293	823	
	Nesting	99D3048T26NE	1,173	1,295	1,365	NA	1,284	
	Electric	99D3048T26EH	1,829	1,954	2,025	2,370	1,954	
30 x 60	Static	99D3060T26	830	986	1,062	1,439	892	
	Nesting	99D3060T26NE	1,277	1,430	1,504	NA	1,380	
	Electric	99D3060T26EH	1,907	2,063	2,139	2,517	2,023	
30 x 72	Static	99D3072T26	908	1,095	1,175	1,586	1,005	
	Nesting	99D3072T26NE	1,447	1,631	1,709	NA	1,615	
	Electric	99D3072T26EH	1,985	2,172	2,252	2,663	2,136	
30 x 84	Static	99D3084T26	1,054	1,273	1,357	1,800	1,168	
	Nesting	99D3084T26NE	1,664	1,878	1,961	NA	1,851	
30 x 90	Static	99D3090T26	1,093	1,327	1,414	1,873	1,213	
	Nesting	99D3090T26NE	1,777	NA	NA	NA	NA	
30 x 96	Static	99D3096T26	1,132	1,382	1,470	1,946	1,259	
	Nesting	99D3096T26NE	1,853	NA	NA	NA	NA	
36 x 48	Static	99D3648T26	814	964	1,027	1,389	896	
	Nesting	99D3648T26NE	1,234	1,381	1,443	NA	1,355	
	Electric	99D3648T26EH	1,891	2,041	2,105	2,467	2,027	
36 x 60	Static	99D3660T26	908	1,095	1,158	1,547	1,005	
	Nesting	99D3660T26NE	1,475	1,659	1,721	NA	1,619	
	Electric	99D3660T26EH	1,985	2,172	2,236	2,624	2,136	
36 x 72	Static	99D3672T26	1,001	1,226	1,289	1,701	1,110	
	Nesting	99D3672T26NE	1,659	1,880	1,941	NA	1,844	
	Electric	99D3672T26EH	2,079	2,304	2,366	2,778	2,241	

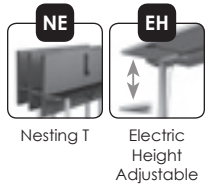

Surge

- LC**  
+90
- OS**  
+35
- CH**  
NA
- WM**  
NA
- WMLC**  
+45
- FT**  
NA
- SH**  
T+130
- FR**  
NA
- PB**  
NA
- GR**  
+40
- CM**  
+50
- RC**  
+55
- GN**  
+40
- LT**  
NA

Top Size	Base	Model Number	3P	3K	3W	W1-W4	F1-F5	D-shaped with T-bases	<b>NEW</b>
36 x 84	Static	99D3684T26	\$ 1,163	\$ 1,426	\$ 1,488	\$ 1,927	\$ 1,202		
	Nesting	99D3684T26NE-LT	1,884	NA	NA	NA	NA		
36 x 90	Static	99D3690T26	1,210	1,491	1,554	2,008	1,356		
	Nesting	99D3690T26NE-LT	1,930	NA	NA	NA	NA		
36 x 96	Static	99D3696T26	1,257	1,557	1,619	2,085	1,367		
	Nesting	99D3696T26NE-LT	1,976	NA	NA	NA	NA		

Nesting T    Electric Height Adj.

Top Size	Base	Model Number	3P	3K	3W	W1-W4	F1-F5	Half Round with T-bases	<b>NEW</b>
30 x 60	Static	99HR3060T22	825	982	1,043	1,826	908		
	Nesting	99HR3060T22NE	1,245	1,399	1,458	NA	1,367		
	Electric	99HR3060T22EH	1,903	2,059	2,120	2,904	2,039		
36 x 72	Static	99HR3672T26	1,000	1,225	1,270	2,178	1,114		
	Nesting	99HR3672T26NE	1,603	1,823	1,868	NA	1,726		
	Electric	99HR3672T26EH	2,077	2,302	2,347	3,255	2,245		

Nesting T    Electric Height Adjustable

Top Size	Base	Model Number	3P	3K	3W	W1-W4	F1-F5	Crescent with T-bases	<b>NEW</b>
24 x 48 x 75	Static	99CS2475T22	\$ 1,228	\$ 1,546	\$ 1,494	\$ 1,830	\$ 1,595		
	Electric	99CS2475T22EH	2,305	2,623	2,571	2,907	2,726		
24 x 60 x 94	Static	99CS2494T22	1,551	1,998	1,898	2,107	1,595		
	Electric	99CS2494T22EH	2,628	3,076	2,976	3,184	2,726		
30 x 60 x 94	Static	99CS3094T26	1,557	2,004	1,901	2,271	1,600		
	Electric	99CS3094T26EH	2,634	3,081	2,978	3,348	2,732		

Electric Height Adj.

Top Size	Base	Model Number	3P	3K	3W	W1-W4	F1-F5	Trapezoid with T-bases	<b>NEW</b>
30 x 60	Static	99TZ3060T22	\$ 784	\$ 924	\$ 992	\$ 1,595	\$ 908		
	Nesting	99TZ3060T22NE	1,204	1,342	1,409	NA	1,367		
	Electric	99TZ3060T22EH	1,861	2,001	2,069	2,673	2,039		
36 x 72	Static	99TZ3672T26	978	1,193	1,240	1,943	1,114		
	Nesting	99TZ3672T26NE	1,554	1,766	1,811	NA	1,762		
	Electric	99TZ3672T26EH	2,055	2,271	2,317	3,021	2,245		

Nesting T    Electric Height Adjustable

- LC**  
+90
- OS**  
+35
- CH**  
NA
- WM**  
NA
- WMLC**  
+45
- FT**  
NA
- SH**  
T+130
- FR**  
NA
- PB**  
NA
- GR**  
+40
- CM**  
+50
- RC**  
+55
- GN**  
+40
- LT**  
NA

NEW

Arc Segment with T-bases	Top Size	Base	Model Number	3P	3K	3W	W1-W4	F1-F5
<p>Electric Height Adjustable</p>	24 x 51	Static	99AS2451T22	\$ 780	\$ 919	\$ 947	NA	\$ 768
		Electric	99AS2451T22EH	1,858	1,996	2,024	NA	1,899
	30 x 59	Static	99AS3059T26	855	1,022	1,054	NA	914
		Electric	99AS3059T26EH	1,933	2,099	2,131	NA	2,045
	36 x 67	Static	99AS3667T26	1,022	1,255	1,278	NA	1,114
		Electric	99AS3667T26EH	2,099	2,332	2,355	NA	2,245

NEW

Ganging Quarter Round (with T-base)	Top Size	Base	Model Number	3P	3K	3W	W1-W4	F1-F5
	24 x 24	Ganging	QR2424GN	\$ 233	\$ 284	\$ 344	NA	\$ 236
	30 x 30	Static, GN	99QR3030GNT22	489	567	632	NA	489
		Ganging	QR3030GN	301	380	444	NA	292
	36 x 36	Static, GN	99QR3636GNT22	553	657	727	NA	639
		Ganging	QR3636GN	365	469	540	NA	442

1 base: **LC** **OS** **SH**  
NA +18 +65

NEW

Surge

Ganging 45° Wedge (with T-base)	Top Size	Base	Model Number	3P	3K	3W	W1-W4	F1-F5
	24 x 24	Ganging	WG45D24GN	\$ 233	\$ 284	\$ 337	NA	\$ 236
	30 x 30	Ganging	WG45D30GN	301	380	432	NA	292
	36 x 36	Static, GN	99WG45D36GNT22	553	657	708	NA	639
		Ganging	WG45D36GN	365	469	520	NA	442



1 base: **LC** **OS** **SH**  
NA +18 +65



NEW



Ganging 60° Wedge (with T-base)	Top Size	Base	Model Number	3P	3K	3W	W1-W4	F1-F5
	24 x 24	Ganging	WG60D24GN	\$ 254	\$ 314	\$ 366	NA	\$ 236
	30 x 30	Static, GN	99WG60D30GNT22	510	597	650	NA	489
		Ganging	WG60D30GN	322	410	462	NA	292
	36 x 36	Static, GN	99WG60D36GNT22	574	687	741	NA	639
		Ganging	WG30D36GN	386	499	553	NA	442



1 base: **LC** **OS** **SH**  
NA +18 +65

- LC**  
+90
- OS**  
+35
- CH**  
NA
- WM**  
NA
- WMLC**  
+45
- FT**  
NA
- SH**  
T+130
- FR**  
NA
- PB**  
NA
- GR**  
+40
- CM**  
+50
- RC**  
+55
- GN**  
+40
- LT**  
NA

Top Size	Base	Model Number	3P	3K	3W	W1-W4	F1-F5	Video Wedge with T-bases	<i>new</i>	
24 x 24 x 48	Static	99VW2448T22	\$ 711	\$ 822	\$ 894	NA	\$ 744	 		
	Electric	99VW2448T22EH	1,788	1,899	1,972	NA	1,875			
30 x 30 x 60	Static	99VW3060T26	855	1,022	1,092	NA	914			
	Electric	99VW3060T26EH	1,933	2,099	2,169	NA	2,045			
36 x 36 x 72	Static	99VW3672T26	1,105	1,372	1,406	NA	1,114			 <p>Electric Height Adjustable</p>
	Electric	99VW3672T26EH	2,183	2,449	2,483	NA	2,245			

Top Size	Base	Model Number	3P	3K	3W	W1-W4	F1-F5	10° Transition with T-bases	<i>new</i>	
24 x 30	Static	99TN2430T22	\$ 583	\$ 643	\$ 713	NA	\$ 634	 		
	Electric	99TN2430T22EH	1,660	1,720	1,790	NA	1,766			
30 x 30	Static	99TN3030T26	644	726	791	NA	686			
	Electric	99TN3030T26EH	1,721	1,803	1,869	NA	1,817			
36 x 30	Static	99TN3630T26	708	816	873	NA	731			 <p>Electric Height Adjustable</p>
	Electric	99TN3630T26EH	1,785	1,893	1,951	NA	1,863			

Top Size	Base	Model Number	3P	3K	3W	W1-W4	F1-F5	Bulb with X-base	<i>new</i>
30 x 30 x 20	Static	99BU3020X22	\$ 731	\$ 877	\$ 882	1,542	\$ 608	 	
36 x 36 x 24	Static	99BU3624X26	839	1,028	1,023	1,810	711		
	Count Bal	99BU3624X26BL	1,265	1,454	1,450	2,236	1,158		
42 x 42 x 30	Static	99BU4230X30	999	1,227	1,216	2,158	896		
	Count Bal	99BU4230X30BL	1,667	1,895	1,884	2,826	1,597		
48 x 48 x 36	Static	99BU4836X34	1,028	1,260	1,269	2,462	1,049		
	Count Bal	99BU4836X34BL	1,696	1,929	1,937	3,130	1,750		

Top Size	Base	Model Number	3P	3K	3W	W1-W4	F1-F5	Table Desk with T-bases	<i>new</i>
37 x 60	Static	99TA3760T26	\$ 902	\$ 1,087	\$ 1,194	\$ 1,886	\$ 1,020	 	
	Electric	99TA3760T26EH	1,979	2,164	2,272	2,963	2,151		
								 <p>Electric Height Adjustable</p>	

- LC**  
+90
- OS**  
+35
- CH**  
NA
- WM**  
NA
- WMLC**  
+45
- FT**  
NA
- SH**  
T+130  
X+65
- FR**  
NA
- PB**  
+90
- GR**  
+40
- CM**  
+50
- RC**  
+55
- GN**  
+40
- LT**  
NA

Laminate Modesty Panels	Top Size	Base	Model Number	Hardware	3P	3W	F2
	10 x 36	Static	MP1036	02 Black	\$ 104	\$ 216	\$ 159
		Nesting	MP1036NE	02 Black	173	284	231
 static	10 x 48	Static	MP1048	02 Black	125	267	161
		Nesting	MP1048NE	02 Black	194	335	233
	10 x 60	Static	MP1060	02 Black	146	317	266
 folding	10 x 72	Folding	MP1060FD	02 Black	275	446	402
		Nesting	MP1060NE	02 Black	215	385	338
	10 x 84	Static	MP1072	02 Black	179	379	279
 folding	10 x 72	Folding	MP1072FD	02 Black	296	497	403
		Nesting	MP1072NE	02 Black	236	436	339
	10 x 84	Static	MP1084	02 Black	200	429	281
 folding	10 x 90	Folding	MP1084FD	02 Black	393	623	484
		Nesting	MP1084NE	02 Black	302	532	388
	10 x 90	Static	MP1090	02 Black	232	477	294
 nesting	10 x 96	Folding	MP1090FD	02 Black	414	660	485
		Nesting	MP1090NE	02 Black	323	569	390
	10 x 96	Static	MP1096	02 Black	232	491	294
 nesting	10 x 96	Folding	MP1096FD	02 Black	414	673	485
		Nesting	MP1096NE	02 Black	323	582	390

Top Size	Base	Model Number	Hardware	Price	Frosted Acrylic Modesty Panels
10 x 36	Static or Nesting	MAP1036	-BL -SV	\$ 272	
10 x 48	Static or Nesting	MAP1048	-BL -SV	383	
10 x 60	Static or Nesting	MAP1060	-BL -SV	390	
10 x 72	Static or Nesting	MAP1072	-BL -SV	397	
10 x 84	Static or Nesting	MAP1084	-BL -SV	486	
10 x 90	Static or Nesting	MAP1090	-BL -SV	486	
10 x 96	Static or Nesting	MAP1096	-BL -SV	493	

Top Size	Base	Model Number	Finish	Price	Perforated Metal Modesty Panels
9 x 48	Static or Nesting	MMP948	Powdercoated	\$ 360	
9 x 60	Static or Nesting	MMP960	Powdercoated	381	
9 x 72	Static or Nesting	MMP972	Powdercoated	402	

Top Size	Base	Model Number	Color	Price	Mesh Modesty Panels
10 x 36	Static or Nesting	MSP1036	Black mesh	\$ 188	
10 x 48	Static or Nesting	MSP1048	Black mesh	197	
10 x 60	Static or Nesting	MSP1060	Black mesh	209	
10 x 72	Static or Nesting	MSP1072	Black mesh	220	
10 x 84	Static or Nesting	MSP1084	Black mesh	231	
10 x 90	Static or Nesting	MSP1090	Black mesh	235	
10 x 96	Static or Nesting	MSP1096	Black mesh	241	

# privacy panels

NEW

Laminate Privacy Panels	Top Size	Base	Model Number	Hardware	3P	3W	F2
	10 x 36	Static	PP1036	Silver	\$ 180	\$ 291	\$ 238
	10 x 48	Static	PP1048	Silver	201	342	240
	10 x 60	Static	PP1060	Silver	222	393	346
	10 x 72	Static	PP1072	Silver	243	443	347
	10 x 84	Static	PP1084	Silver	313	543	400
	10 x 90	Static	PP1090	Silver	334	580	401
	10 x 96	Static	PP1096	Silver	334	593	401

NEW

Extended Laminate Privacy Panels	Top Size	Base	Model Number	Hardware	3P	3W	F2
	22 x 36	Static	EPP2236	02 Black	\$ 263	\$ 411	\$ 335
	22 x 48	Static	EPP2248	02 Black	314	495	338
	22 x 60	Static	EPP2260	02 Black	366	580	553
	22 x 72	Static	EPP2272	02 Black	418	664	556
	22 x 84	Static	EPP2284	02 Black	514	793	605
	22 x 90	Static	EPP2290	02 Black	540	835	606
	22 x 96	Static	EPP2296	02 Black	566	877	608

Accessories



Top Size	Base	Model Number	Hardware	Price
10 x 36	Static	PAP1036	Silver	\$ 207
10 x 48	Static	PAP1048	Silver	319
10 x 60	Static	PAP1060	Silver	326
10 x 72	Static	PAP1072	Silver	333
10 x 84	Static	PAP1084	Silver	389
10 x 90	Static	PAP1090	Silver	389
10 x 96	Static	PAP1096	Silver	396

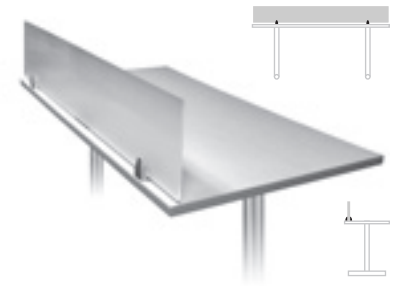

**NEW**

Top Size	Base	Model Number	Hardware	Price
22 x 36	Static	EPAP2236	Chrome	\$ 276
22 x 48	Static	EPAP2248	Chrome	477
22 x 60	Static	EPAP2260	Chrome	488
22 x 72	Static	EPAP2272	Chrome	495
22 x 84	Static	EPAP2284	Chrome	550
22 x 90	Static	EPAP2290	Chrome	550
22 x 96	Static	EPAP2296	Chrome	553

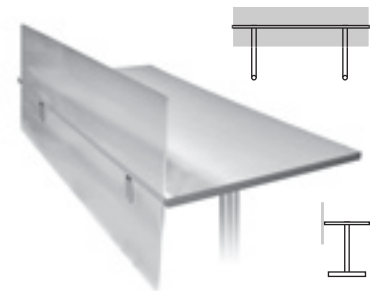

**NEW**

Accessories

# power/data units

## Metal pop-up units

Each of our metal pop-up units feature a single touch door opening which closes when not in use. These units are available in a multitude of configurations balancing your need for conventional (15 amp/125 volt) power with USB power and data jacks.

**Finishes:** Choose between Black and Anodized Aluminum.

**Cord:** Choose between 72" and 120" length. All feature 15 amp/125 volt. Some units require two cords.

**Cutout:** You do not need to specify a grommet or add any upcharge to your table price. The cost of the cutout is included in the price of the unit.

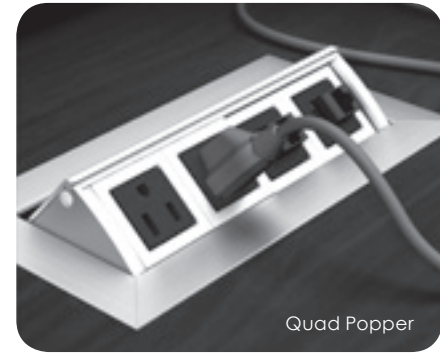

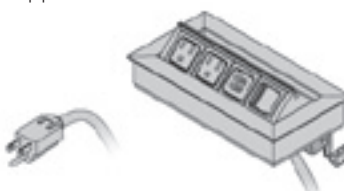
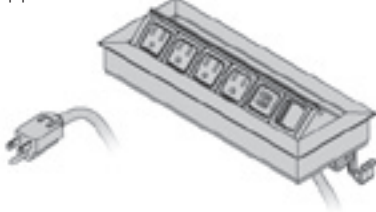
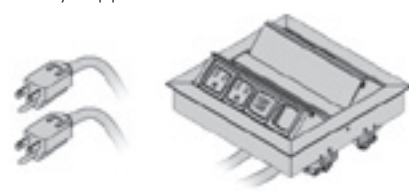
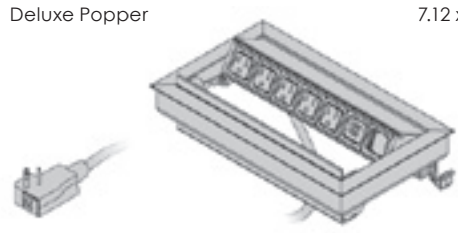
Product	Approx. Size	Configuration	Cord	Model Number	BL	AA
 Twin Popper	4 x 5"	2 Power	72"	PD04-2P-72	\$ 219	\$ 219
			120"	PD04-2P-120	228	228
		1 Power + 1 KO	72"	PD04-1P-1D-72	208	208
			120"	PD04-1P-1D-120	217	217
 Quad Popper	4 x 8"	4 Power	72"	PD06-4P-72	509	398
			120"	PD06-4P-120	518	407
		2 Power + 2 KO	72"	PD06-2P-2D-72	404	318
			120"	PD06-2P-2D-120	413	327
 Hex Popper	4 x 11"	6 Power	72"	PD14-6P-72	595	464
			120"	PD14-6P-120	606	473
		3 Power + 3 KO	72"	PD14-3P-3D-72	443	348
			120"	PD14-3P-3D-120	452	356
 Butterfly Popper	8 x 8"	8 Power	72"	PD08-8P-72	943	733
			120"	PD08-8P-120	961	750
		4 Power + 4 KO	72"	PD08-4P-4D-72	805	626
			120"	PD08-4P-4D-120	823	644
 Deluxe Popper	7.12 x 12.5"	7 Power	72"	PD10-7P-72	734	572
			120"	PD10-7P-120	743	581
		5 Power + 2 KO	72"	PD10-5P-2D-72	620	484
			120"	PD10-5P-2D-120	629	493
		5 Power + 2 USB + 1 KO	72"	PD10-5P-2U-72	762	625
			120"	PD10-5P-2U-120	770	634

Power/Data

## Plastic units





These units are designed with an eye on the fixed budget. They are available in a multitude of configurations balancing your need for conventional (15 amp/125 volt) power with USB power and data jacks.

**Finishes:** Choose between Black and White. Other finishes are available for those units marked with "#". Visit [www.byrne.com](http://www.byrne.com) to view those options.

**Cord:** Choose between 72" and 120" length. All feature 15 amp/125 volt.

**Cutout:** You do not need to specify a grommet or add any upcharge to your table price. The cost of the cutout is



Product	Approx. Size	Configuration	Cord	Model Number	Color	List
 <b>new</b>	2" round	1 Power	72"	PD15R-1P-72	-BL -WH -#	78
			120"	PD15R-1P-120	-BL -WH -#	87
	2" square	1 Power	72"	PD15Q-1P-72	-BL -WH -#	78
			120"	PD15Q-1P-120	-BL -WH -#	87
 <b>new</b>	2" round	1 USB	72"	PD15R-1U-72	-BL -WH -#	193
	2" square	1 USB	72"	PD15Q-1U-72	-BL -WH -#	193
 <b>new</b>	3.75" round	3 Power	72"	PD17-3P-72	-BL -WH -#	161
			120"	PD17-3P-120	-BL -WH -#	170
		2 Power + 1 USB	72"	PD17-2P-1U-72	-BL -WH -#	221
			120"	PD17-2P-1U-120	-BL -WH -#	230
 <b>new</b>	5" round	3 Power	72"	PD16-3P-72	-BL -WH -#	215
			120"	PD16-3P-120	-BL -WH -#	243
		2 Power + 1 USB	72"	PD16-2P-1U-72	-BL -WH -#	298
			120"	PD16-2P-1U-120	-BL -WH -#	307
	3 x 6"	2 Power + 2 KO	72"	PD02-2P-2D-72	-BL	\$ 179
			120"	PD02-2P-2D-120	-BL	188

Power/Data

"Hemisphere" and "Eclipse" are trademarks of Byrne Electrical Specialists.

# power/data units



## Villa™ Daisylink™ System

The Villa Daisylink system is a 4 wire, 2 circuit hardwire system which allows for non-sequential plug and play use. Link up to 20 single kits or 10 double kits in a row using one of three power infeed options.

Grommet holes are pre-routed in the top, and each unit comes with a flush grommet cover.

### 3 finishes available:

- BL: Black grommet, black body
- SV: Silver grommet, silver body
- WH: White grommet, black body

**Infeeds:** You must specify a power infeed unit for each row or grouping of tables. The number of kits that can be supported per row varies depending on the infeed specified.



### Single Kit includes:

- 1 Villa power base
- 1 FM cable
- 1 FF cable
- 4 cable clamps
- 1 grommet (on -L / -F models)



### Double Kit includes:

- 2 Villa power bases
- 1 FM cable
- 2 FF cable
- 6 cable clamps
- 2 grommets (on -L / -F models)





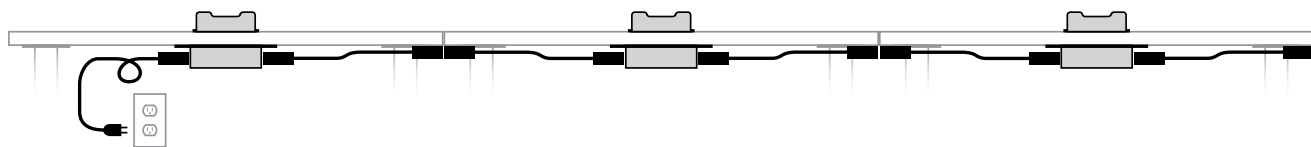





## How does the Villa Daisylink System work?

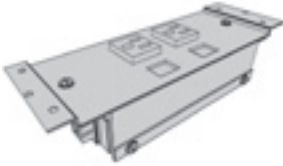

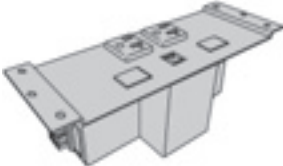

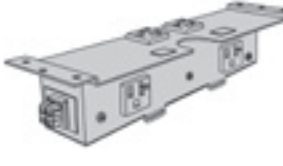
Daisylink Accessories	Description	Visual	Cord	Model Number	Price
20/15 AMP Plug Infeed 	- 20 AMP outlet with standard 15 AMP adapter can be plugged into any standard wall outlet. - Feeds up to 10 units.		72	VAP-72	\$ 168
Hardwire Infeed 	- 2 circuit system hardwired into wall and plugs into first table in the row. - Feeds up to 20 units.		72 120	VHW-72 VHW-120	117 179
Quick Disconnect Kit 	- Hardwired wall unit paired with an FF jumper unit which plugs into first table in the row. - Feeds up to 20 units.		72 120	VQD-72 VQD-120	206 259
FM Jumper Unit 	- Great for linking tables around a corner, face to face, bypassing a non-powered table, or two tables that are not in perfect alignment.		12 24 36 48 60 72	VFM-12 VFM-24 VFM-36 VFM-48 VFM-60 VFM-72	71 84 97 111 124 137
Splitter 	- Splits power to feed tables running in different directions			VT-MFM	116

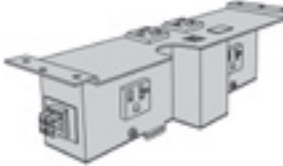
"Villa" and "Daisylink" are trademarks of Electri-Cable Assemblies.

Single Villa Kits	Double Villa Kits
-------------------	-------------------

Villa Daisylink Kits	Grommet Cover	Table Size	Model No.	List	Model No.	List
2 Power + 2 KO 	3.25 x 5.5" Flush 	36"	V36SP-2P	357	NA	
		48"	V48SP-2P	357	NA	
		60"	V60SP-2P	357	V60DP-2P	634
		72"	V72SP-2P	357	V72DP-2P	634
		84"	V84SP-2P	357	V84DP-2P	634
		90"	V90SP-2P	357	V90DP-2P	634
		96"	V96SP-2P	357	V96DP-2P	634
<b>new</b> 2 Power + 1 USB + 2 KO 	3.25 x 5.5" Flush 	36"	V36SP-2P-1U	429	NA	
		48"	V48SP-2P-1U	429	NA	
		60"	V60SP-2P-1U	429	V60DP-2P-1U	816
		72"	V72SP-2P-1U	429	V72DP-2P-1U	816
		84"	V84SP-2P-1U	429	V84DP-2P-1U	816
		90"	V90SP-2P-1U	429	V90DP-2P-1U	816
		96"	V96SP-2P-1U	429	V96DP-2P-1U	816
<b>new</b> 2 Power + 2 Convenience + 2 KO 	3.25 x 5.5" Flush 	36"	V36SP-2P-2C	375	NA	
		48"	V48SP-2P-2C	375	NA	
		60"	V60SP-2P-2C	375	V60DP-2P-2C	670
		72"	V72SP-2P-2C	375	V72DP-2P-2C	670
		84"	V84SP-2P-2C	375	V84DP-2P-2C	670
		90"	V90SP-2P-2C	375	V90DP-2P-2C	670
		96"	V96SP-2P-2C	375	V96DP-2P-2C	670
<b>new</b> 2 Power + 2 USB + 2 Convenience + 1 KO 	3.25 x 5.5" Flush 	36"	V36SP-2P-1U-2C	484	NA	
		48"	V48SP-2P-1U-2C	484	NA	
		60"	V60SP-2P-1U-2C	484	V60DP-2P-1U-2C	852
		72"	V72SP-2P-1U-2C	484	V72DP-2P-1U-2C	852
		84"	V84SP-2P-1U-2C	484	V84DP-2P-1U-2C	852
		90"	V90SP-2P-1U-2C	484	V90DP-2P-1U-2C	852
		96"	V96SP-2P-1U-2C	484	V96DP-2P-1U-2C	852
2 Convenience Underbar + 2 KO 	None	36"	V36SP-2C	266	NA	
		48"	V48SP-2C	266	NA	
		60"	V60SP-2C	266	V60DP-2C	453
		72"	V72SP-2C	266	V72DP-2C	453
		84"	V84SP-2C	266	V84DP-2C	453
		90"	V90SP-2C	266	V90DP-2C	453
		96"	V96SP-2C	266	V96DP-2C	453

Villa Accessories	Description	Model Number	List
<b>new</b> Villa RJ45 Data Keystone 	- Fits into blank data knockouts	V-RJ45	\$ 50
<b>new</b> Villa HDMI Keystone 	- Fits into blank data knockouts	V-HDMI	\$ 50

"Villa" and "Daisylink" are trademarks of Electri-Cable Assemblies.

# power/data units



## Cove™ Daisylink™ System

The Cove Daisylink system is a 4 wire, 2 circuit hardwire system which allows for non-sequential plug and play use. Link up to 20 single kits or 10 double kits in a row using one of three power infeed options.

Grommet holes are pre-routed in the top. All outlets and body of unit is black.

### 3 face plate finishes available:

- BL: Black
- SV: Silver
- WH: White

**Infeeds:** You must specify a power infeed unit for each row or grouping of tables. The number of kits that can be supported per row varies depending on the infeed specified.



- Single Kit includes:**
- 1 Cove power base
  - 1 FM cable
  - 1 FF cable
  - 4 cable clamps
  - 1 grommet (on -L / -F models)



- Double Kit includes:**
- 2 Cove power bases
  - 1 FM cable
  - 2 FF cable
  - 6 cable clamps
  - 2 grommets (on -L / -F models)



### How does the Cove Daisylink System work?

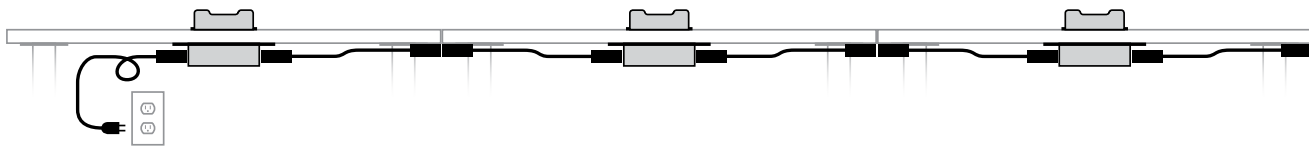









Daisylink Accessories	Description	Visual	Cord	Model Number	Price
20/15 AMP Plug Infeed 	- 20 AMP outlet with standard 15 AMP adapter can be plugged into any standard wall outlet. - Feeds up to 10 units.		72	VAP-72	\$ 168
Hardwire Infeed 	- 2 circuit system hardwired into wall and plugs into first table in the row. - Feeds up to 20 units.		72 120	VHW-72 VHW-120	117 179
Quick Disconnect Kit 	- Hardwired wall unit paired with an FF jumper unit which plugs into first table in the row. - Feeds up to 20 units.		72 120	VQD-72 VQD-120	206 259
FM Jumper Unit 	- Great for linking tables around a corner, face to face, bypassing a non-powered table, or two tables that are not in perfect alignment.		12 24 36 48 60 72	VFM-12 VFM-24 VFM-36 VFM-48 VFM-60 VFM-72	71 84 97 111 124 137
Splitter 	- Splits power to feed tables running in different directions			VT-MFM	116

"Cove" & "Daisylink" are trademarks of Electri-Cable Assemblies.

Power/Data

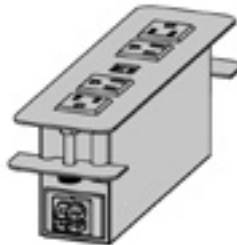
Single Cove Kits	Double Cove Kits
------------------	------------------

Cove Daisylink Kits	Face Plate	Table Size	Model No.	List	Model No.	List
<p>2 Power</p>  <p><b>new</b></p>	<p>2.5 x 5"</p> 	36"	C36SP-2P	357	NA	
		48"	C48SP-2P	357	NA	
		60"	C60SP-2P	357	C60DP-2P	634
		72"	C72SP-2P	357	C72DP-2P	634
		84"	C84SP-2P	357	C84DP-2P	634
		90"	C90SP-2P	357	C90DP-2P	634
		96"	C96SP-2P	357	C96DP-2P	634
<p>2 Power + 2 USB</p>  <p><b>new</b></p>	<p>2.5 x 5.75"</p> 	36"	C36SP-2P-2U	466	NA	
		48"	C48SP-2P-2U	466	NA	
		60"	C60SP-2P-2U	466	C60DP-2P-2U	852
		72"	C72SP-2P-2U	466	C72DP-2P-2U	852
		84"	C84SP-2P-2U	466	C84DP-2P-2U	852
		90"	C90SP-2P-2U	466	C90DP-2P-2U	852
		96"	C96SP-2P-2U	466	C96DP-2P-2U	852
<p>4 Power</p>  <p><b>new</b></p>	<p>2.5 x 7.75"</p> 	36"	C36SP-4P	520	NA	
		48"	C48SP-4P	520	NA	
		60"	C60SP-4P	520	C60DP-4P	961
		72"	C72SP-4P	520	C72DP-4P	961
		84"	C84SP-4P	520	C84DP-4P	961
		90"	C90SP-4P	520	C90DP-4P	961
		96"	C96SP-4P	520	C96DP-4P	961
<p>4 Power + 2 USB</p>  <p><b>new</b></p>	<p>2.5 x 8.75"</p> 	36"	C36SP-4P-2U	629	NA	
		48"	C48SP-4P-2U	629	NA	
		60"	C60SP-4P-2U	629	C60DP-4P-2U	1,178
		72"	C72SP-4P-2U	629	C72DP-4P-2U	1,178
		84"	C84SP-4P-2U	629	C84DP-4P-2U	1,178
		90"	C90SP-4P-2U	629	C90DP-4P-2U	1,178
		96"	C96SP-4P-2U	629	C96DP-4P-2U	1,178

"Cove" & "Daisylink" are trademarks of Electri-Cable Assemblies.



# power/data units

## Villa™ Corded System

This system is built with easy plug-and-play capabilities and reconfiguration in mind. Each table can be plugged into the wall separately or can be piggy-backed off of the next table. (Max of 6 units in any run.)

### 3 finishes available:

- BL: Black grommet, black body
- SV: Silver grommet, silver body
- WH: White grommet, black body

Grommet holes are pre-routed in the top, and each unit comes with a flush grommet cover.



### How does the Villa Corded System work?

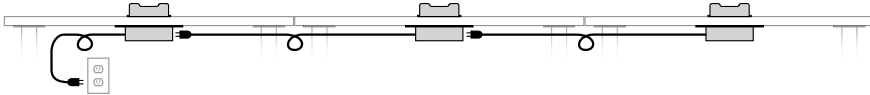

Villa Corded Units	Grommet Cover	Model Number	Cord	Color	List
2 Power + 1 Convenience + 2 KO 	3.25 x 5.5" Flush 	VC-2P-1C-___	-36 -72 -108	-BL -SV -WH	\$ 277
<b>new</b> 2 Power + 2 USB + 1 Convenience + 2 KO 	3.25 x 5.5" Flush 	VC-2P-2U-1C-___	-36 -72 -108	-BL -SV -WH	\$ 386
<b>new</b> 2 Power + 3 Convenience + 2 KO 	3.25 x 5.5" Flush 	VC-2P-3C-___	-36 -72 -108	-BL -SV -WH	\$ 331
<b>new</b> 2 Power + 2 USB + 3 Convenience + 1 KO 	3.25 x 5.5" Flush 	VC-2P-2U-3C-___	-36 -72 -108	-BL -SV -WH	\$ 440
3 Convenience Undermount 	None	VC-3C-___	-36 -72 -108	-BL -SV	\$ 176
Villa Accessories	Description	Model Number	List		
Villa RJ45 Data Keystone 	- Fits into blank data knockouts	V-RJ45	\$ 50		
<b>new</b> Villa HDMI Keystone 	- Fits into blank data knockouts	V-HDMI	\$ 50		

Power/Data



# power/data units

## Cove™ Corded System

Smooth access to power and USB power that runs flush to the table top.

Some models are available with convenience outlets to allow table to be piggy-backed off of the next table. (Max of 6 units in any run.)

Grommet holes are pre-routed in the top. All outlets and body of unit is black.

### 3 face plate finishes available:

- BL: Black
- SV: Silver
- WH: White







Cove Corded Units	Face Plate	Specs	Model Number	Color	List
<b>new</b> 		2.5 x 5" Rectangle	CC108-2P	-BL -SV -WH	\$ 248
		6" Round	CC108-2P-RD	-BL -SV -WH	\$ 248
	2.5 x 5.75"	Rectangle +1 Convenience	CC108-2P-1C	-BL -SV -WH	\$ 266
			2.5 x 5.75" Rectangle	CC108-2P-2U	-BL -SV -WH
<b>new</b> 		6" Round	CC108-2P-2U-RD	-BL -SV -WH	\$ 357
		2.5 x 7.75" Rectangle +2 Convenience	CC108-2P-2U-2C	-BL -SV -WH	\$ 466
<b>new</b> 		2.5 x 7.75" Rectangle	CC108-4P	-BL -SV -WH	\$ 411
<b>new</b> 		2.5 x 8.75" Rectangle	CC108-4P-2U	-BL -SV -WH	\$ 447
<b>new</b> 		2.5 x 10.75" Rectangle	CC108-6P	-BL -SV -WH	\$ 429
<b>new</b> 		2.5 x 13.25" Rectangle	CC108-6P-4U	-BL -SV -WH	\$ 593

"Cove" is a trademark of Electri-Cable Assemblies.

Product	Description	Length	Model Number	Color	Price
 <p>Built in Wire Management Leg</p>	1 x 19" steel hinged access door built into one base. Door runs within 2.5" of top plate and bottom of base. Door height varies depending on series and options. Not available on all series. Check series intro for compatibility. Upcharge is \$125 per table.	NA	-WM	NA	+ \$ 125
 <p>Snap-on Wire Management Leg Cover</p>	Snaps on to round columns and offers coverage of wires down the leg. Check series intro for compatibility. Powdercoated steel to match base color.	NA	-WMLC	matches base color	45
 <p><b>new</b> Magnetic Wire Management Leg Cover</p>	Magnetically attaches to rectangular and square bases, offering coverage of wires down the leg. Check series intro for compatibility. Powdercoated steel to match base color.	NA	-MMLC	matches base color	55
 <p>Vertical Spine Management 3 x 1.5</p>	Oval spine conceals and carries wires from under desk to floor. Single channel on each side to keep cords separate where code requires. Screws to under side of worksurface with weighted base. Available in silver metallic.	30" 42"	WMH WMH-SH	Silver Silver	105 150
 <p>J-Channel Management 3.25 x 1"</p>	Ideal when cords need to be moved often. Can be attached to underside of the table or to a modesty panel. Self adhesive tape applied for easy installation. Black plastic.	12" 36" 60" 72"	WMA1 WMA3 WMA5 WMA6	Black Black Black Black	20 40 60 80
 <p>Four Channel Management 3 x .75"</p>	Four subtle openings to load wires in separate channels to meet local codes. Can be attached to underside of the table or to a modesty panel. Self adhesive tape applied for easy installation. Black plastic.	12" 36" 60"	WMC1 WMC3 WMC5	Black Black Black	30 50 80

Power/Data

Product	Description	Length	Model Number	Color	Price
Vertebrae Management 3.125 x 1" 	Contains four separate channels. Two main channels and two smaller which allow wires to sit in a .5" trough. Black plastic.	36"	WMD3	Black	\$ 60
Velcro Straps 3.5 x 1.75" 	Ideal for applications where you just need a few little wire guides along the way. Attach to underside of table or back of modesty panel using double-sided tape.	NA	WMV	Black	15 ea.
Grommet 2.75 x 2.75" 	Add grommets to any table top for \$40 each. Use chart below to select grommet location. For example, add "-GR.D" at the end of the model number for a table needing two grommets in location D and add \$80 to the list price. Black plastic.	NA	-GR. __	Black	+40 ea.
Cable Manager 3 x 6.5" 	Cable managers are essentially extra wide grommets. Use chart below to select location. For example, add "-CM.D" at the end of the model number for a table needing two cable managers in location D and add \$100 to the list price. Black plastic.	NA	-CM. __	Black	+50 ea.

Where would you like your grommets?

for custom locations, please provide a drawing with your order

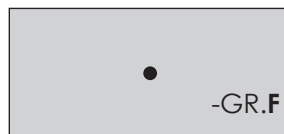
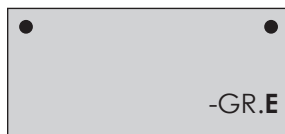
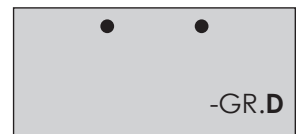
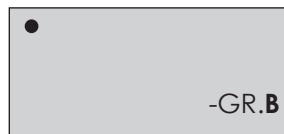

Power/Data



Need tables right away? TableX is able to ship the following models in just 5 business days after receiving a clean order. All tables come with black powdercoated Fundamental bases, but you can choose any of our standard laminates and 3mm PVC edges to create the look your client needs. Maximum order of 25 tables.

### Fundamental Bases



### Base Standards

standard  
glides



### Edge Options

3mm PVC

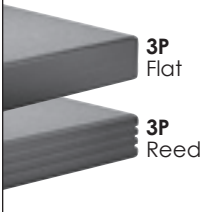

### Standard Finish Options



**Laminates:**  
All standards  
are available.  
Visit [TableX.com](http://TableX.com)  
for current list.

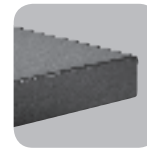

**3mm Edges:**  
All standards  
are available.  
Visit [TableX.com](http://TableX.com)  
for current list.



**Bases:**  
02 Black

### Top Shapes

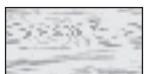

rectangle  
p.205



racetrack  
p.205



square  
p.205



round  
p.205



modesty panels  
p.205



**Rectangular with T-bases**

Top Size	Base	Model Number	3P
24 x 36	Static	QS-02TC2436T20	506
24 x 48	Static	QS-02TC2448T20	551
24 x 60	Static	QS-02TC2460T20	571
24 x 72	Static	QS-02TC2472T20	609
24 x 84	Static	QS-02TC2484T20	750
30 x 60	Static	QS-02TC3060T26	614
30 x 72	Static	QS-02TC3072T26	657
30 x 84	Static	QS-02TC3084T26	827
36 x 60	Static	QS-02TC3660T26	706
36 x 72	Static	QS-02TC3672T26	747
36 x 84	Static	QS-02TC3684T26	903



**Modesty Panels**

Size	Base	Model Number	3P
10 x 36	Static	QS-MP1036	104
10 x 48	Static	QS-MP1048	125
10 x 60	Static	QS-MP1060	146
10 x 72	Static	QS-MP1072	179
10 x 84	Static	QS-MP1084	200



**Square with X-base**

Top Size	Base	Model Number	3P
30 x 30	Static	QS-02SQ3030X32	464
36 x 36	Static	QS-02SQ3636X32	524



**Round with X-base**

Top Size	Base	Model Number	3P
36 x 36	Static	QS-02RD36X32	584
42 x 42	Static	QS-02RD42X32	678



**Racetrack with T-bases**

Top Size	Base	Model Number	3P
36 x 60	Static	QS-02RT3660T26	829
36 x 72	Static	QS-02RT3672T26	917
36 x 84	Static	QS-02RT3684T26	1,074

A large grid of 25 columns and 30 rows, intended for planning or data entry. The grid is composed of thin black lines forming a uniform pattern of small squares.

A large grid of 20 columns and 30 rows, intended for planning or data entry. The grid is composed of thin black lines forming a uniform pattern of small squares.

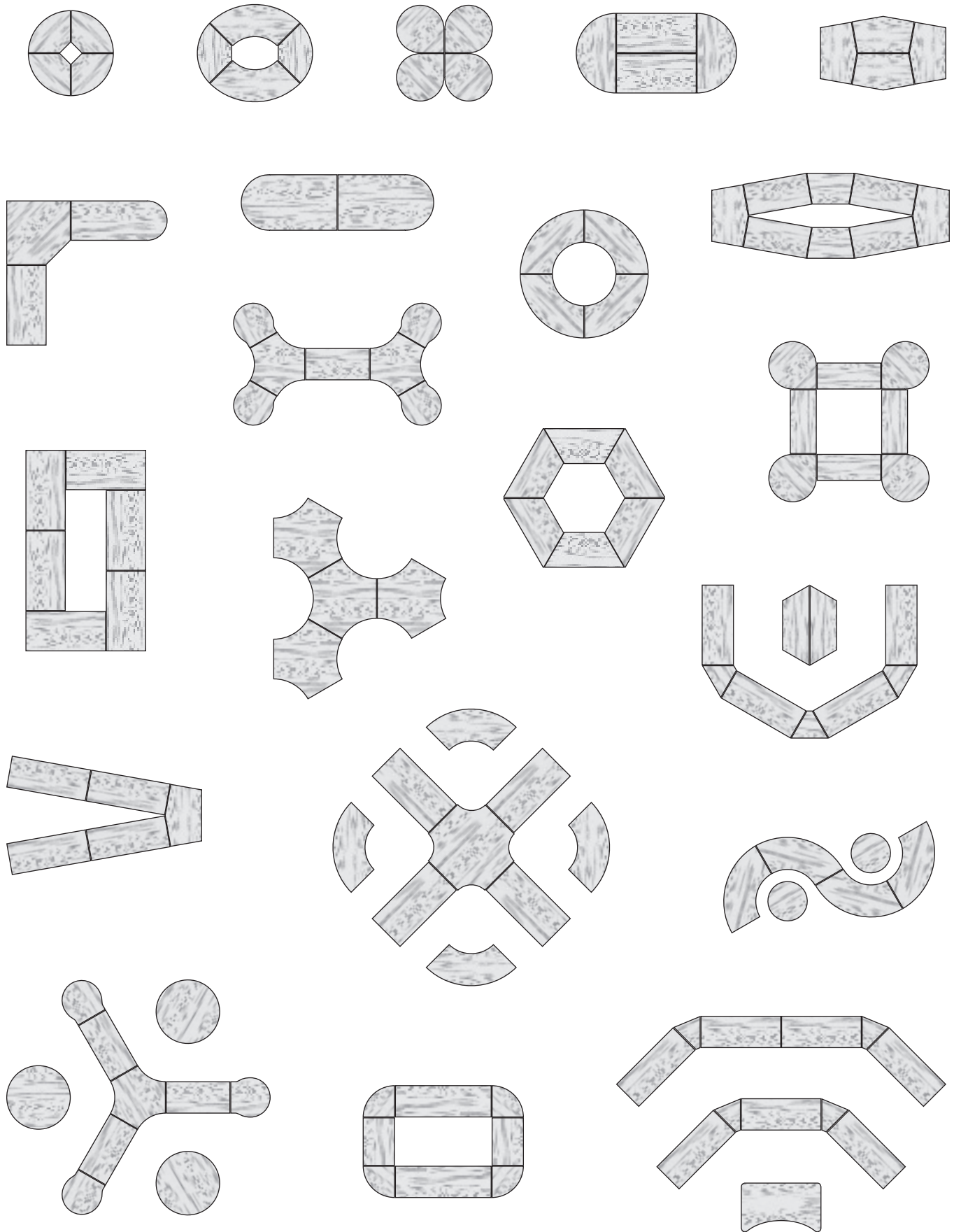





tableX





p · 877.481.1177  
f · 812.481.1178

555 Cathy Lane  
Jasper, IN 47546

© 2018 TableX, LLC  
Form # TXPL-18