



tablex



price list

Effective May 16, 2022





Welcome to our 2022 TableX price list. We have made a number of important product additions and several deletions to this most recent price book update. More table solutions are forthcoming, so please confirm you have the most current TableX product details and list prices by visiting: tablex.com/pricing.

If you have any questions, or need something above and beyond the standard solutions shown in this book, please don't hesitate to contact us. We welcome custom requests and are here to help you.

TableX customer service: **877.481.1177**
sales@tablex.com

Introduction	Page
Pricing Comparison	p. 2
Terms & Conditions	p. 4
<ul style="list-style-type: none"> • Pricing • Orders • Order Acknowledgements • Terms • Lead Times • Modified Product • Cancellations & Returns 	
Freight	p. 5
<ul style="list-style-type: none"> • Freight Charges • Shipping 	
Sample Purchase Order	p. 6
Warranty	p. 7
Surface Materials	p. 8
<ul style="list-style-type: none"> • High Pressure Laminates • Powdercoat Base Colors • 3mm PVC Edges • 3mm PVC Knife Edges • Wood Edges (3mm only) • Coordinating Finishes 	
Table Options	p. 12
<ul style="list-style-type: none"> • Nesting Tables • Folding Tables • Flip Top Tables • Folding Tables • Top Options • Base Options • Custom Height Options • Height Adjustable Options 	
Seating Capacities	p. 20

Product Pricing	Page
TableXpress Quickship Program	p. 22
00 - Ultra Series	p. 28
01 - Foundation Series	p. 36
02 - Fundamental Series	p. 52
06 - Stretch Series	p. 68
08 - Elite Series	p. 84
17 - App Series	p. 102
33 - Element Series	p. 106
40 - Justice Series	p. 120
44 - Primary Series	p. 128
45 - Puddle Series	p. 144
71 - Exclaim Series	p. 150
74 - VertiGo Series	p. 164
99 - Surge Series	p. 184
Table Accessories	p. 202
<ul style="list-style-type: none"> • Modesty Panels • Privacy Panels 	
Power / Data	p. 208
<ul style="list-style-type: none"> • Metal Pop-up Units • Budget Units • Daisylink Systems • Corded Systems 	
Wire Management	p. 216

24x60" Rectangles

Something as simple as a 24x60" rectangular table can be specified many different ways. With 12 different standard series of bases, TableX has you covered. Use the matrix below to compare list pricing of each series, using a static, 24x60" rectangular table with a 3P (3mm PVC) edge.



Ultra

p.32



\$1,000 List

Foundation

p.40

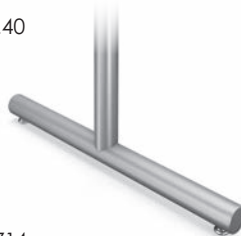

\$714

Fundamental

p.56



\$706

Stretch

p.72

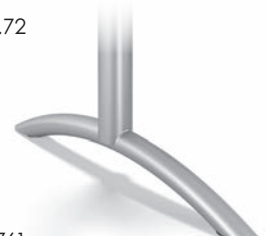

\$761

Elite

p.88



\$906

Element

p.110



\$761

Justice

p.124



\$1,258

Primary

p.132

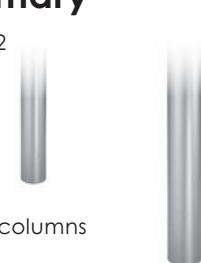

four columns
\$821

Primary

p.133



two 44 discs
\$1,711

Puddle

p.148



two 45 discs
\$1,477

Exclaim

p.156



\$1,021

VertiGo

p.171



\$797

Surge

p.190



\$829

Surge

p.192











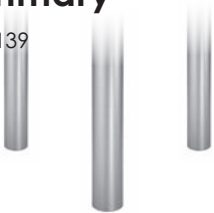

two 99 discs
\$1,406

36" Rounds

Cafe and lounge tables are being utilized everywhere. TableX offers a wide variety of bases that give you plenty of choices. Use the matrix below to compare list pricing of each series, using a static, 36" round table with a 3P (3mm PVC) edge.

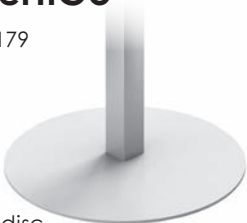

<p>Foundation p.47</p>  <p>\$745 List</p>	<p>Fundamental p.63</p>  <p>\$708</p>	<p>Stretch p.79</p>  <p>\$952</p>	<p>Elite p.97</p>  <p>\$912</p>
<p>Element p.115</p>  <p>\$918</p>	<p>Primary p.139</p>  <p>four columns \$811</p>	<p>Primary p.139</p>  <p>44 disc \$1,085</p>	<p>Puddle p.149</p>  <p>45 disc \$968</p>
<p>VertiGo p.179</p>  <p>\$958</p>	<p>VertiGo p.179</p>  <p>74 disc \$972</p>	<p>Surge p.197</p>  <p>\$900</p>	<p>Surge p.197</p>  <p>99 disc \$933</p>

Pricing

All prices quoted are list prices, FOB our warehouse. All documentation and literature is based on the most recent information available at the time of this publication. We reserve the right to make product improvements and design enhancements at any time, without notice. Prices are subject to change without notification.

Orders

All orders must be received in writing with complete information. See page 6 for a sample purchase order and a checklist of information that is required to place an order.

E-mail orders to:
sales@tablex.com

Fax orders to:
812.481.1178

Duplicate orders that are not marked as such are the responsibility of the customer.

Order Acknowledgements

Orders are acknowledged upon receipt at TableX. No order shall be binding upon TableX until we confirm it with an acknowledgement. The customer bears sole responsibility for order correctness. All orders will be manufactured and invoiced in accordance with the acknowledgement. Customers must notify TableX in writing of any discrepancy **within 5 days**. Any subsequent change order is dependent upon our ability to accommodate the specification, terms and status of the order in production, and may be subject to additional charges for labor, material and other costs involved.

Terms

Terms are Net 30 days from the date of invoice. Payment is due when invoice is issued and is considered delinquent if not paid within 30 days. Interest will be charged at the rate of 1.5% per month on delinquent accounts. TableX does not create or provide statements.

Lead Times

Lead times can vary based on product availability, fluctuations in busy season, and national holidays. Please contact customer service at 877.481.1177 for current lead times.

Note: Selecting certain options (3mm wood edges, chrome bases, or solid surface tops) can impact lead time. Below are estimated lead times based on normal business conditions.

Laminate	Edge	Base	Standard Lead Time
<i>TableXpress Program</i>			<i>7-10 day quickship</i>
standard	3mm PVC	standard	4-5 weeks
solid surface tops			4-6 weeks
	3mm wood		6-8 weeks
		chrome	8 weeks

Modified Product

TableX prides itself on providing you with product that exceeds your expectations. Sometimes your needs are outside the standard product offering. Our flexibility as a smaller company allows us to accommodate requests for non-cataloged product. Contact Customer Service at 877.481.1177 to discuss your unique product requirements and we'll help you meet your needs.

Cancellations & Returns

Our acceptance of an order is final and binding and not subject to cancellation by the customer. No merchandise may be returned without the written consent of TableX. When ordering electrical components on pages 228-235, it is the responsibility of the customer to ensure the components selected meet local electrical codes. Electrical components are made-to-order and cannot be returned.

Freight Charges

TableX is located in Jasper, Indiana. All shipping zones are based on proximity to our facility.

Minimum Orders

Standard freight charges apply to any order under \$3,000 total list price shipping within the continental United States. The standard charge for each zone is shown below, based on the total list price of the order.

Tiered Freight Program

These freight charges are reduced or waived on orders based on their total list price. The qualifying list prices for each zone are shown below.

Shipping

All shipments are F.O.B., dock-to-dock from our warehouse. Charges for additional services such as lift gates, non-commercial deliveries, inside deliveries, oversized pallets (pallets used for single table tops 96" or longer), and call before delivery are the responsibility of the buyer and may be charged to the buyer after the date of delivery.

Legal responsibility for the product transfers to the buyer upon acceptance by the carrier. Damaged, lost or shorted shipments are the responsibility of the carrier. Inspect all shipments promptly upon arrival and note any damage or loss on the delivery receipt. If damage is concealed, keep the packing and notify the carrier immediately for an inspection. Carriers require such reports within 5 days of delivery. Failure to report damage or loss is the consignee's responsibility. The freight charges may be collect to the receiver, billed to the purchaser, or prepaid by TableX.

Freight Claims

Legal title to merchandise passes to the buyer upon acceptance by the carrier. All cartons must be carefully inspected upon delivery for visible and concealed damage. If concealed damage has occurred, the carrier must be notified within (5) days. All of our product is thoroughly inspected before it leaves the factory, therefore it is the buyer's responsibility to seek recourse against the carrier.

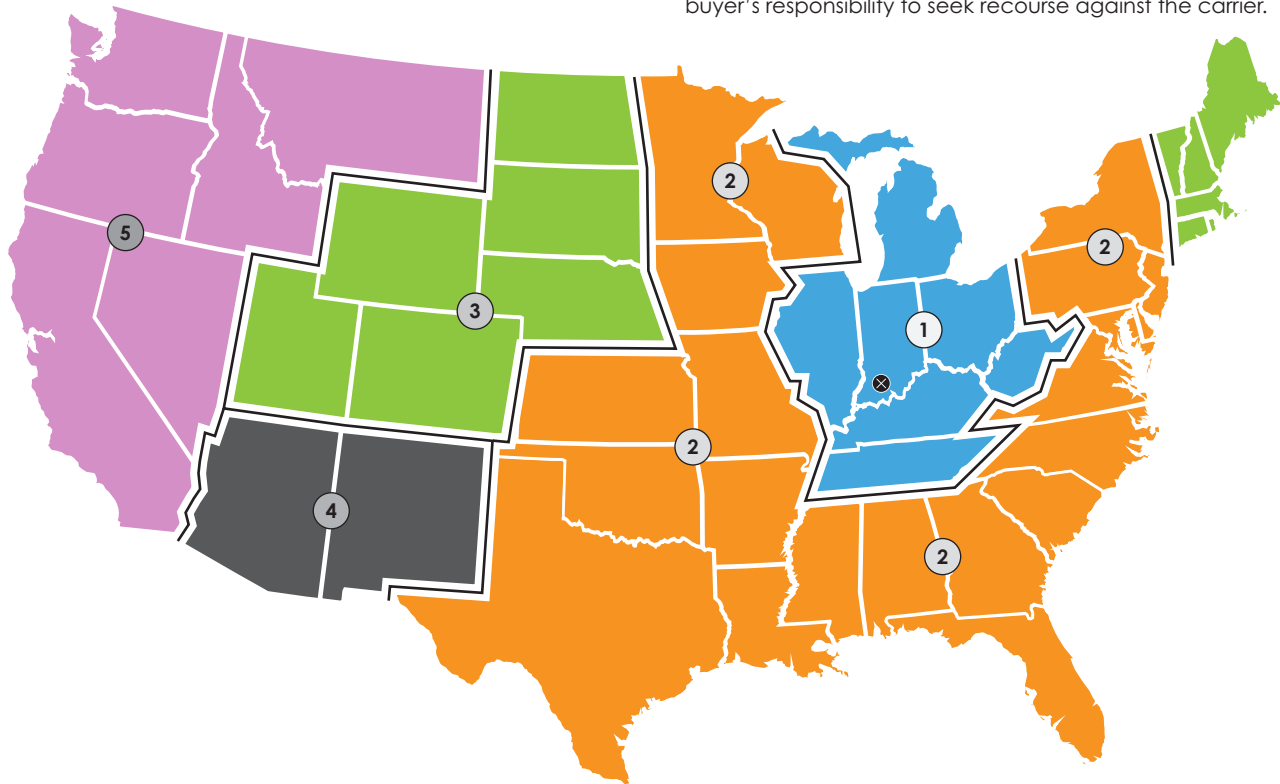

Zone	Destination State	Total List Price / Freight Charge				
		< \$3K	> \$3K	> \$5K	> \$7.5K	> \$10K
1	IL, IN, KY, MI, OH, TN, WV	\$150	free freight			
2	AL, AR, DE, FL, GA, IA, KS, LA, MD, MN, MO, MS, NC, NJ, NY, OK, PA, SC, TX, VA, WI	\$250	\$150	free freight		
3	CO, CT, MA, ME, ND, NE, NH, RI, SD, UT, VT, WY	\$300	\$250	\$150	free freight	
4	AZ, NM	\$350	\$300	\$250	\$150	free
5	CA, ID, MT, NV, OR, WA	freight charge must be quoted				

Email orders to:
sales@tablex.com

Fax orders to:
812.481.1178

When sending in a purchase order, please be sure to include the following items. Each of these is important to ensure that your order is processed accurately and in a timely manner.



Furniture Dealer
123 Main St.
Middletown, US 12345

ph. 123.456.7890
fax 123.456.7890

PURCHASE ORDER

page 1 of 1

PO #	Date
12-34567-89	04 / 15 / 2022

Your PO #

We will include this on your order acknowledgement for easy tracking.

TO: TableX
555 Cathy Lane
Jasper, IN 47546

SHIP TO: Furniture Dealer
123 Main St.
Middletown, US 12345

'Ship To' Address

Check page 5 to see how location will affect freight charges.

Line	Quantity	Model # / Description	Unit Price	Ext. Price
		Special Instructions: Call 24 hours before delivery: James Abbott, 123.456.7890 Dealer contact: Peter Gray, 123.456.7890		
1	12	01TC2460T22NE-3P-GR.A - 7960K-18/3021/37 Foundation 24x60" rectangular table with 22" wide T-bases. NE: nesting with locking casters GR.A: 1 grommet in location A List Price: \$1,116 Discount: 50/10 Laminate: Wilsonart 7960K-18 Studio Teak 3P: 3MM EDGE: 3021 Espresso BASE: 37 Satin Silver TAG: training room	502.20	6,026.40
2	5	08RD48X36-3W - 7054-60/NG/21 Elite 48" round table with 36" wide X-base. List Price: \$1,460 Discount: 50/10 Laminate: Wilsonart 7054-60 Wild Cherry 3mm Wood - NG-Nutmeg BASE: 21 Silver Frost TAG: break room	657.00	3,285.00
Freight			0.00	0.00
Total order amount				9,311.40

Special Instructions

This includes but is not limited to a requested delivery date, call before delivery, dealer contact, and tagging instructions.

Complete Model #

include any options and your surface materials.

List Price & Discount

This is important so that we can double check any options and upcharges.

Surface Materials

Double check to make sure these are included. this is the piece most often left off of a PO.

Freight Charges

Many larger orders qualify for free freight. reference the chart on page 5 to verify your costs.

Line Item #
Makes cross referencing much easier if we have any questions.

Quantity
Exactly how many of these do you need?

Product Tagging
We will include this on the label underneath each table.



Warranty

Effective April 15, 2020

TableX merchandise limited warranty on the original purchase covers normal use for 50 years from date of shipment against defect regarding workmanship and materials.

Electrical components are covered for 1 year. Moving components; such as, but not exclusive to; casters, flip top mechanisms and height adjustment mechanisms are covered for 5 years. Note of exception on Nesting Extrusions, warranty is 10 years.

Formica, Wilsonart, Pionite, and Nevamar laminates are covered by the specified surface manufacturer under their particular warranty only. TableX does not promote laminate "self edge" tops due to their tendency to be damaged during everyday use. Self edge and butcher block tops are done by special request only and are covered for 1 year.

Finishes, when exposed to ultraviolet rays, may change color. Desktop accessories with rubber or plastic feet can penetrate or burn a finish. These issues are not warranted and will not be the responsibility of TableX.

- Exclusions include:**
- Normal wear and tear over course of ownership or abuse beyond originally intended use of product.
 - Modifications or additions to the product, or final product assembly that is not TableX approved.
 - Product used for rental purposes
 - Damage caused by misapplication of cleaning chemicals or improper use of core and cleaning procedures.
 - Surface materials damaged by excessive humidity or dryness in an uncontrolled environment.

When ordering tops or bases ONLY; TableX will not be held liable for any tops or bases used in conjunction with any other manufacturer's products.

Any repairs or modifications by the customer must receive specific written authorization from TableX prior to being executed, or warranty may be voided.

In no event shall liability under this warranty exceed the original purchase price of the product.

All TableX products are tested to meet or exceed BIFMA standards.

High Pressure Laminates

Standard Laminates

TableX stocks over 40 laminates. With a large selection of patterns, solids, and woodgrains, these laminates are all available at standard pricing.

Special Laminates

TableX also offers Wilsonart, Nevamar, Pionite, and Formica laminates. Please contact customer service to confirm pricing and availability of any non-standard laminates.

TableXpress Quickship Program

When ordering TableXpress quickship products, you must select from our standard list of stocked laminates.

Samples

Laminate samples are available by request. Scans of these laminates are also available on tablex.com for reference, but because of variations in monitor and printer calibration we do not suggest specifying without seeing a physical sample.

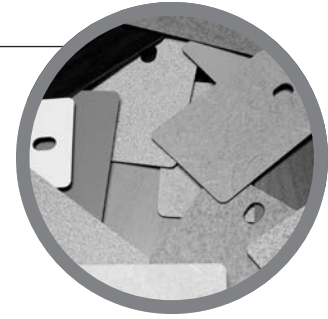

Pattern Laminates		Solid Laminates		Woodgrain Laminates	
299-58	Ebony Oxide	D96-60	Shadow*	7054-60	Wild Cherry *
4621-60	White Nebula*	D315-60	Platinum*	7122K-07	Empire Mahogany *
4622-60	Grey Nebula	D354-60	Designer White*	7933K-07	Cafelle *
4623-60	Graphite Nebula*	D355-60	Gunmetal*	7943K-07	Colombian Walnut *
4656-60	Bronze Legacy*	D439-60	Wallaby*	7946-38	Brazilwood *
4668-60	Mushroom Tigris	1500-60	Grey*	7960K-18	Studio Teak *
4779-60	Pewter Brush	1573-60	Frosty White*	7965K-12	Walnut Heights *
4783-60	White Tigris*	1595-60	Black*	10776-60	Kensington Maple *
4810-60	Titanium Ev*	D91-60	Slate Gray*		
4811-60	Silicon Ev	D381-60	Fashion Grey*		
4813-60	Nickel Ev	D431-60	Alabaster		
4814-60	Tungsten Ev*	899-58	Desert Beige		
4820-60	Carbon Ev*	928-58	Mouse		
4841-60	Desert Zephyr	7197-58	Dover White		
4842-60	Canyon Zephyr	8751-58	Mojave		
4843-60	Misted Zephyr				
4844-60	Loden Zephyr				
4846-60	Morro Zephyr				
4876-38	Sheer Mesh				
4879-38	Steel Mesh				
4942-38	Crisp Linen				
6220-58	Smoke Quarstone				
6729-58	Paloma Bisque				
7708-58	Flax Gauze				
8830-58	Elemental Concrete				

* Matching standard 3mm edge available.

Powdercoat Base Colors

Standard Powdercoat Finishes

TableX offers 30 different powdercoat finishes. Most product lines are available in the full offering of powdercoat colors. Check the series intro for any product specific limitations.

Chrome

Chrome is available on several of our table lines for a standard upcharge per table. Please check the series intro for availability. Also note that chrome bases add 4 weeks to the standard leadtime.

Samples

Paint samples are available by request. Scans of these paint colors are also available on tablex.com for reference, but because of variations in monitor and printer calibration we do not suggest specifying without seeing a physical sample.

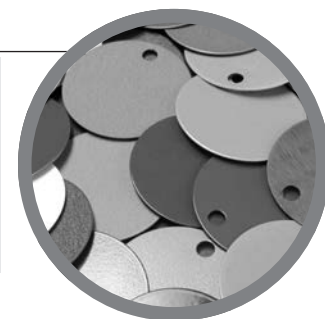

Standard Powdercoat Finishes					
01	Structured Black	37	Satin Silver	49	Dolphin
02	Black	39	Poppy	50	Cannon
05	Structured Slate	40	Rosey	51	Glitz
17	Creme	41	Scarlet	53	Fawn
21	Silver Frost	42	Kiwi	54	Nickel
23	Phantom	43	Kale	55	Pewter
24	Linen	44	Evergreen	56	Kona
25	Storm	45	Horizon	57	Jet
29	Flint	46	Lagoon	58	Cinder
30	Pearl	47	Moonlight		
35	Sand	48	Arctic		

Premium Finishes	
CH	Chrome

Height Adjustable Finishes					
21	Silver Frost	40	Rosey	47	Moonlight
25	Storm	41	Scarlet	55	Pewter
29	Flint	42	Kiwi	56	Kona
30	Pearl	43	Kale	57	Jet
35	Sand	44	Evergreen		
37	Satin Silver	45	Horizon		
39	Poppy	46	Lagoon		

Note

Counterbalance height adjustable tables are only available in 30 Pearl, 57 Jet, or 37 Satin Silver. Electric height adjustable tables are only available in 57 Jet or 37 Satin Silver.

3mm PVC Edges



3P
Flat

Standard Edges

TableX stocks 9 solid edge colors and 18 woodgrain edges. Seven of those woodgrain edges are also available as a reeded edge.

TableXpress Quickship Program: When ordering TableXpress quickship products, you must select from our standard list of 3mm PVC edges. Knife edge is not available.

Samples

Edge samples are available by request. Scans of these edges are also available on Tablex.com for reference, but because of variations in monitor and printer calibration we do not suggest specifying without seeing a physical sample.



3P
Reed

Solid 3mm PVC Edges

001	Medium Grey *
015	Charcoal *
016	Haze *
D354	Designer White *
1096	Pepperdust
480	Antique White *
2416	Black *
3020	Iron Alloy
7044	Foundry

Woodgrain PVC Edges

TX093	Amaretto Maple	FTX087	Coastal Maple
TX095	Bramble Walnut	FTX089	Colombian Walnut *
TX098	Dusk Walnut	F3022	Warm Cherry
TX103	Walnut Heights *	F3023	Empire Mahogany *
TX104	Studio Teak *	F3024	Traditional Cherry
TX108	Cashew Rift	F3025-2	Blonde Maple 2
TX109	Chestnut Rift	F3026	Cafelle *
TX110	Ashen Rift		
7054	Wild Cherry *		
7946	Brazilwood		
10776	Kensington Maple *		

Woodgrain Reed Edges

RTX087	Coastal Maple
RTX089	Colombian Walnut *
R3022	Warm Cherry
R3023	Empire Mahogany *
R3024	Traditional Cherry
R3025-2	Blonde Maple 2
R3026	Cafelle *

* Matching standard laminate available.

3mm PVC Knife Edges



3K
Knife

Knife Edges

Any standard 3mm edge is available as a knife edge. Simply specify the 3mm edge and also specify the paint color for the angled MDF core. There are six colors available. Each is based on a Wilsonart solid laminate color of the same name.

PVC Knife Edges Core Colors

K91	Slate Grey
K315	Platinum
K354	Designer White
K439	Wallaby
K495	Coffee Bean
K1595	Black



2P
Acrylic

2mm 3D Acrylic Edges

3D Acrylic Edges

For uses in especially high traffic areas that are prone to impact. 2mm acrylic is designed to be long-lasting and resistant to impact and scratches. Provides a metal edge 'look' without the denting of real metal. 5% upcharge for this edge option.

Acrylic Edge Options

3DT	3D Titanium
3DA	3D Aluminum

Wood Edges

Please check top shape for availability. Also note that 3mm wood edges add 2-4 weeks to the standard leadtime.

TableXpress

Wood edged tops are not available on our TableXpress Quickship Program.

Care & Maintenance

Clean all surfaces with water-dampened soft cloth in the direction of the grain. Quickly buff dry.

Immediately remove any liquids that come in contact with the wood surfaces using a blotting action to absorb the liquid. Lift objects to move them. Never pull them across the finished surface.

Avoid exposing furniture to extreme heat and cold or to wide humidity variances. Avoid exposing furniture to strong sunlight. Exposure to sunlight over time will cause finish variation. Do not use soaps, commercial cleaners or harsh solvents as they will cause finish deterioration. If using a protective glass top, place spacer pads under the glass top to allow the wood to breathe.

3W
Flat



Samples

Wood finish samples are available by request. Scans of these finishes are also available on tablex.com for reference, but because of variations in monitor and printer calibration we do not suggest specifying without seeing a physical sample.

Wood Edge Finishes			
AD	Almond	CI	Cocoa Infusion
BH	Butterscotch	CT	Chestnut
BV	Black Velvet	NG	Nutmeg
		SE	Spice

Coordinating Solid Finishes

Standard Base Colors		Solid Laminates		Solid 3mm PVC Edges		PVC Knife Edges Colors	
02	Black	1595-60	Black	2416	Black	K1595	Black
23	Phantom			3018	Shark	K91	Slate Grey
24	Linen			354	Designer White	K354	Designer White
35	Sand			1096	Pepperdust		
		1572-60	Antique White	1572	Antique White		

Coordinating Woodgrain Finishes

Woodgrain Laminates		Woodgrain PVC Edges		Reed Woodgrain PVC Edges	
7122K-07	Empire Mahogany	F3023	Empire Mahogany	R3023	Empire Mahogany
10776-60	Kensington Maple	10776	Kensington Maple		
7933K-07	Cafelle	F3026	Cafelle	R3026	Cafelle
7943-07	Colombian Walnut	FTX089	Colombian Walnut	RTX089	Colombian Walnut
7054-60	Wild Cherry	7054-60	Wild Cherry		
7946-60	Brazilwood	7946-60	Brazilwood		
7965K-12	Walnut Heights	TX103	Walnut Heights		
7960K-18	Studio Teak	TX104	Studio Teak		

Nesting T-bases

Rectangular and half-round tables nest and stow with ease. These tables are noted in the pricer by an "NE" at the end of the model number.

Top sizes and shapes vary slightly by series. Rectangular nesting tables larger than 30x66" use a two-handed release.

Locking casters

All nesting T-base models are already priced to include 2" locking casters.

Offset bases not available on 18"d nesting tables.

Staggered Nesting Dimensions

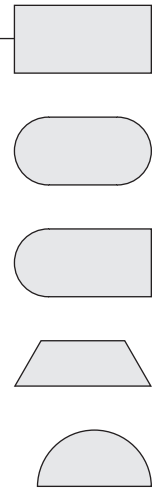
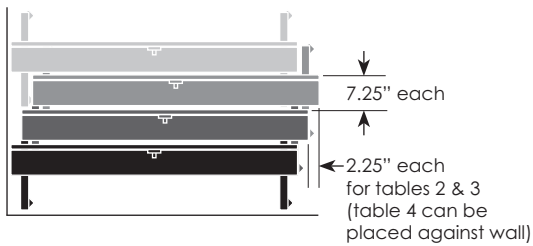

	00 - Ultra	01 - Foundation	02 - Fundamental	06 - Stretch	08 - Elite	33 - Element	44 - Primary	45 - Puddle	71 - Exclaim	74 - VerfiGo	99 - Surge
Nesting Options											
Nesting T		•	•	•	•	•				•	•



Nesting TT-bases

Large square and round tables don't have to be cumbersome. These tables become easily mobile using our two-handed TT nesting. These tables are noted in the pricer by an "NE" at the end of the model number.

This mechanism is used on 60" & 54" rounds, 48" squares, and 42x60" - 48x72" rectangles & D-shapes. Availability varies slightly by base series.

Locking casters

All nesting TT-base models are already priced to include 3" locking casters.

Staggered Nesting Dimensions

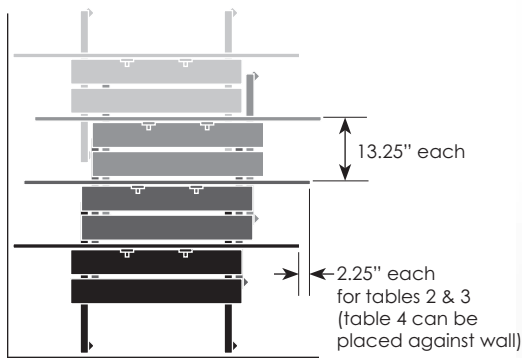

	00 - Ultra	01 - Foundation	02 - Fundamental	06 - Stretch	08 - Elite	33 - Element	44 - Primary	45 - Puddle	71 - Exclaim	74 - VeriGo	99 - Surge
Nesting Options											
Nesting TT	•	•	•	•	•					•	

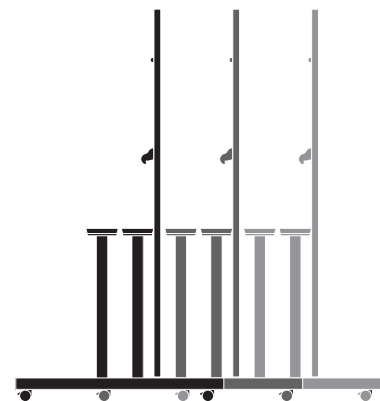
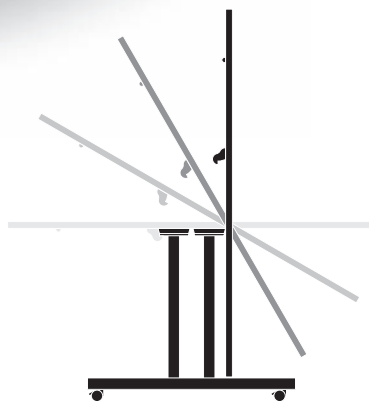

Flip Top X-bases and H-bases

Flip top tables can be a great space saver. These tables are noted in the pricer by an "FT" at the end of the model number.

Round & Square

Availability varies by series. Other options, such as casters, may dictate which sizes are available.

Rectangle & Kidney Bean

Available on VertiGo series H-based tables.



	00 - Ultra	01 - Foundation	02 - Fundamental	06 - Stretch	08 - Elite	33 - Element	44 - Primary	45 - Puddle	71 - Exclaim	74 - VertiGo	99 - Surge
Nesting Options											
Flip Top X	•	•	•	•	•					•	•

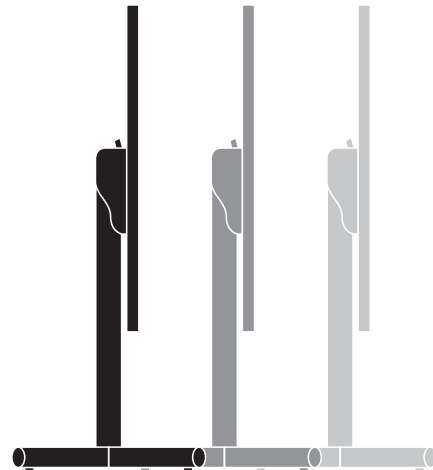
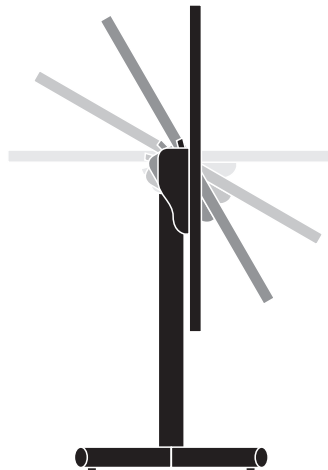
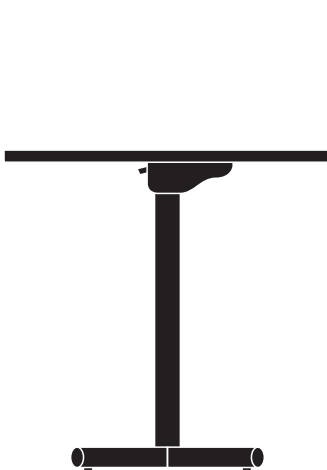

Folding T-bases and TT-bases

Rectangular, racetrack, and some round tables fold for easy storage. These tables are noted in the pricer by an "FD" at the end of the model number.

Standard Folding

Racetrack and rectangular tables 60" and longer use two standard folding mechanisms. Bases fold toward each other and end up toe-to-toe for a total thickness of 4.75" per table.

Short Folding

All round tables and any rectangular tables 48" long or less use a short fold mechanism. Bases fold one over the other for a total thickness of 6.75" per table.

Storage Table Carts

Carts to help store and move tables are available. See pricing below.

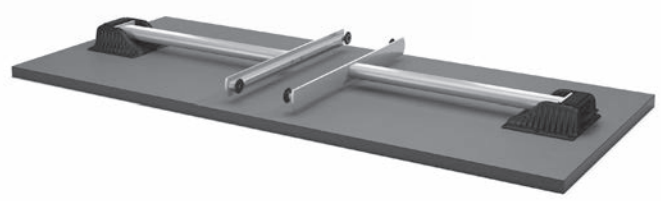
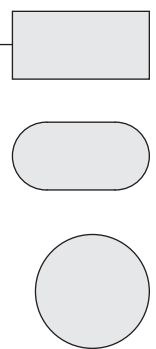

	00 - Ultra	01 - Foundation	02 - Fundamental	06 - Stretch	08 - Elite	33 - Element	44 - Primary	45 - Puddle	71 - Exclaim	74 - VeriGo	99 - Surge
Folding Options											
Folding T		•	•	•	•	•					•
Folding TT		•	•	•	•	•					

Standard Folding

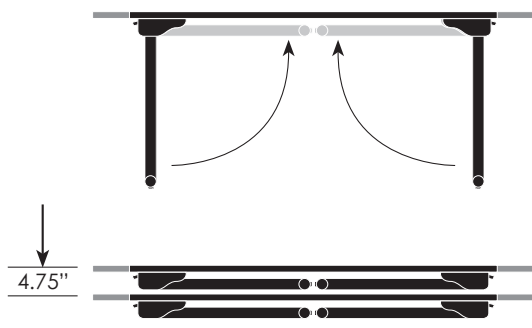

Short Folding

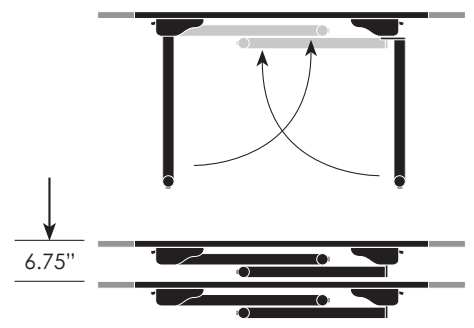

Folding Table Carts

Table Shape	Max Table	Capacity	Model Number	Finish	Price	Mobile Carts
Round	60"	Four short-fold tables	STC-RD60	01 Structured Black	\$ 1,609	
Rectangle	30 x 60"	Six folding tables	STC-TC60	01 Structured Black	1,602	
	30 x 72"	Six folding tables	STC-TC72	01 Structured Black	1,783	
	30 x 84"	Six folding tables	STC-TC84	01 Structured Black	1,812	
	30 x 96 **	Six folding tables	STC-TC96	01 Structured Black	1,947	

RC 3" Radius Corners

3" radius corners soften the corner of tables to give them a smooth feel. Upcharge is \$58 per table.

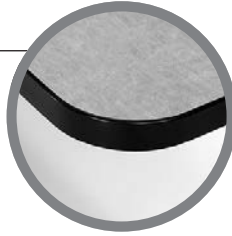

GR Grommets

Grommets can be added to most table shapes for an upcharge of \$42 each. Simply add "-GR" to your model number. 60 mm radius hole. Available in black. See page 217 for location details.

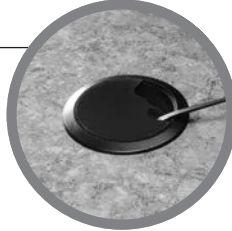

SOLID Solid Surface Tops

Need something a little more substantial? We can offer solid surface tops on many of our tables. These are quite popular on disc and X-based cafe tables. Call customer service for a custom quote. Leadtime on solid surface is usually around 6 weeks.

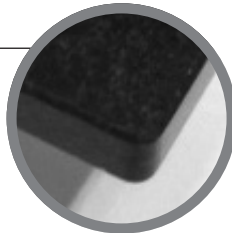

GN Ganging Plates & Knobs

Ganging brackets can be added to most tables for a \$42 upcharge. Note that some top shapes are already priced with ganging brackets included. Two plates and 8 knobs are shipped per table.

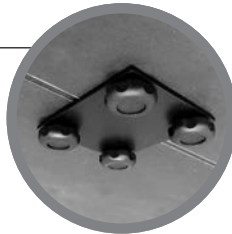

Tables are drilled to gang side-to-side. If face-to-face or another custom configuration is needed please supply a drawing with your purchase order.

QG Quick-Connect Ganging Brackets

Easily connect and disconnect tables or tables of any shape for simple room configurations. Quick to install and built to last, these table connectors will provide clients with durability and functionality for years to come. These allow for seamless assembly and handling with a low profile design. Upcharge is \$42 (includes 4 connectors per table).



PHK Bag Hooks

Accessory hooks are great for hanging coats and purses. This is a simple add on item that works on practically any table. \$11 list each.



MARKER Markerboard Laminates

White markerboard laminate can be specified on any table for an upcharge of \$105 per table. We suggest pairing this with a dark 3mm edge. Call customer service for custom quotes on other markerboard laminates.



MP Modesty & Privacy Panels

Modesty & privacy panels can be added to many table sizes, and some can also be used on folding and nesting models.

Available in laminate, metal, frosted acrylic, and mesh. See pages 204-207 for complete selection and pricing.

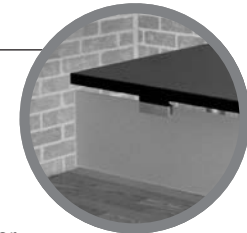

LOGO Custom Logo Tops

Make your laminate table top the focal point of any room by adding your logo in full color. Working with Wilsonart, we can add logos that utilize standard laminates into the background and integrate them into the logos themselves.

This process requires a custom quote, and does require an extended leadtime, but the final results are worth it.



LT Lightweight Tops

Great for use on folding tables, these tops are 40% lighter than our standard tops. Constructed of a bass-wood core with Luan faces. This is a great option when specifying folding tables. Available only on tables with a standard 3mm PVC edge. Upcharge is \$121.

Not available on tops larger than 96". Knife edge not available.



LC Locking Casters

2" locking casters can be added to most tables for an upcharge of \$105 per set of four. Check product details for availability.

Note: nesting tables are priced with locking casters included.

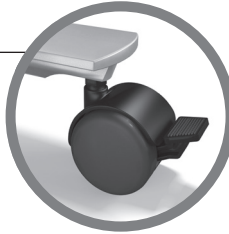

WM Built-in Wire Management

One of two T-bases will have a 1x19" steel access door with self closing hinges. Door height can vary depending on other specified options. Check series details for availability. Upcharge is \$132 per column. See page 216 for details. Not available in chrome.

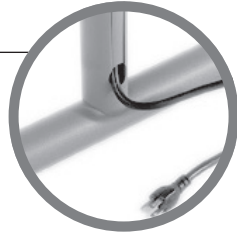

CCG Concealed Casters

Concealed casters can be specified on one side of a T-based table. Other side will have standard glides. Overall height remains at 29". Upcharge is \$130 per table.

Only available on Foundation, Fundamental, & Element series. (Foundation uses black end cap as pictured.)

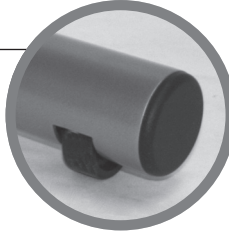

WM LC Snap-on Wire Management Leg Cover

Snaps on to round columns and offers coverage of wires down the leg. Powdercoated steel to match base color. Check series details for compatibility. Upcharge is \$47 for 2" and \$75 for 3" (Surge & Puddle Series). See page 216 for details. Not available in chrome.

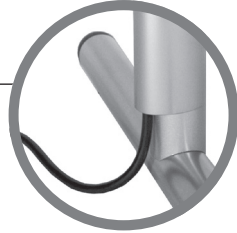

OS Offset T-bases

Most T-bases can be upgraded to offset T-bases. The standard offset is 3". Check product details for availability. Upcharges vary based on series.

Not available on any 18"d tables. Not available on 30"d nesting tables less than 60" wide.

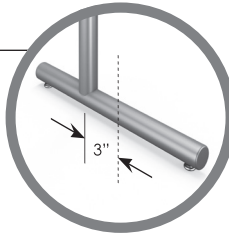

MM LC Magnetic Wire Management Leg Cover

Magnetically attaches to rectangular and square columns and offers coverage of wires down the leg. Powdercoated steel to match base color. Check series details for compatibility. Upcharge is \$67 each. See page 216 for details.

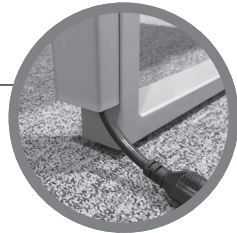

EM Edge Mounted T-bases

T-bases and TT-bases can be specified as edge mounted bases on most static models for \$72. Bases on tables 36-48" in length are already edge mounted.

The position of bases on folding and nesting tables cannot be adjusted.

Table Length	EM
36-48"	standard
60-96"	\$72

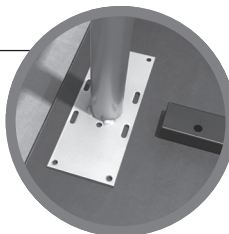

PB Powerbox Mounting Plate

The powerbox is ideal for round and square tables that have a power unit centered in the top. This U-shaped mounting plate allows 2.75x8x12" for the unit itself, wire management through the column, and a hole out the side and bottom of the column. Available on most X-bases and disc bases for \$95 upcharge. \$125 list upcharge on BWE - Bottom Cord Exit on 44 or 99 disc bases.

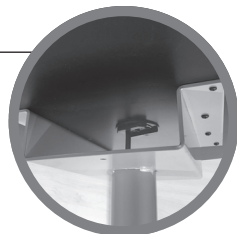

CH Chrome Finish

Chrome finish is a premium finish available on select models. Check product details for availability. Upcharges vary based on series and number of bases.

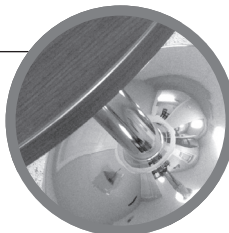

BWE Bottom Cord Exit

Wires are slipped through the column from the mounting plate to the floor. Only available on 44 or 99 disc bases. Upcharge is \$125.

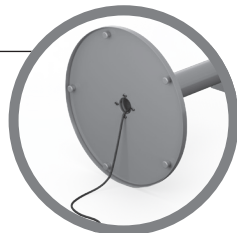

FM LB Floor Mount Leveler Brackets

These brackets are available only as an add-on to our bases and are not for individual sale. Floor mounting hardware not included. Upcharge is \$95 per table.

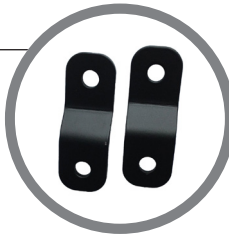

LOGO Fully Customized Tables

Have a customer asking for something a bit outside the box? We pride ourselves in finding ways to solve problems that other manufacturers walk away from. Call customer service and let us know what you need and how we can help create a table just for you.

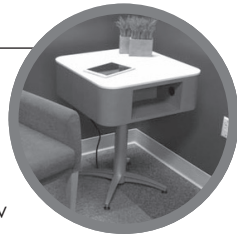

SH Special Height

Special height tables can be specified in most series. Standard height is 29". Upcharges vary based on base and height needed.

Tables larger than 36x72" will need a stretcher bar between the bases. Contact customer service to quote these tables.

When specifying, include your custom height in the model number. For example: (-SH.42) for special height of 42".

Upcharges vary based on base and height needed, see individual series for pricing.

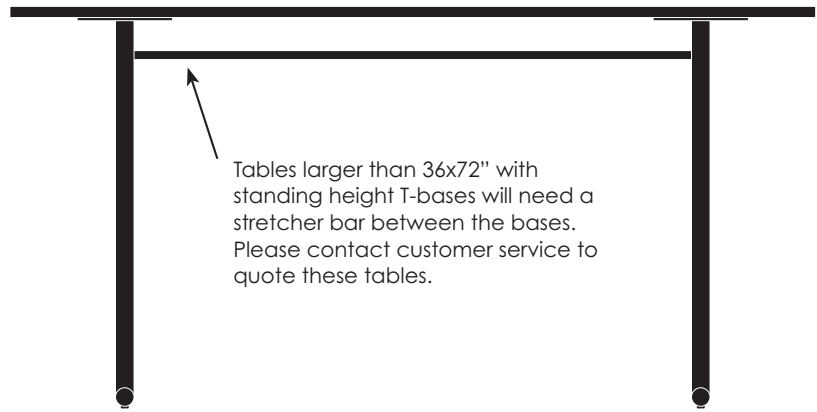
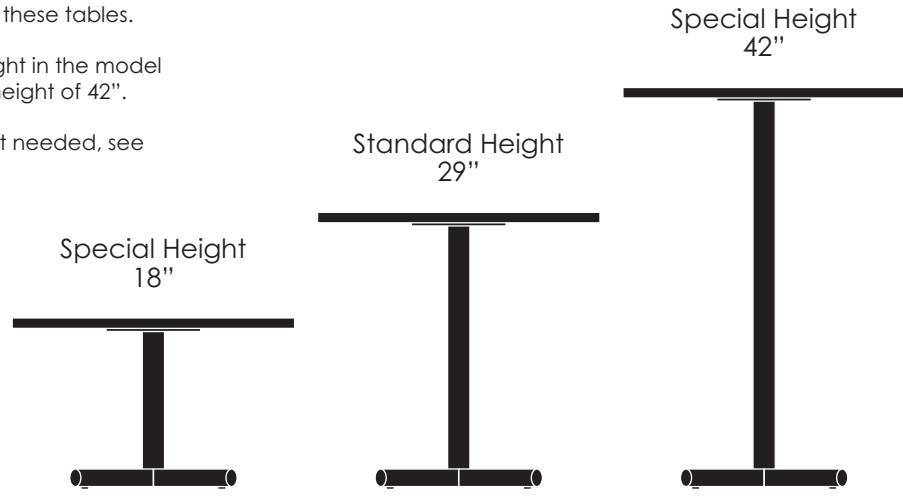

Tables larger than 36x72" with standing height T-bases will need a stretcher bar between the bases. Please contact customer service to quote these tables.

FR Footring

A footring is available on disc bases and select X-bases that are at standing height. Check product details for availability. Upcharge is \$158 per base. Not available in chrome.

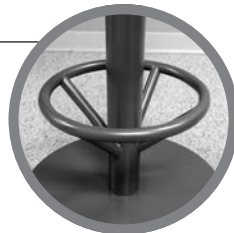



	00 - Ultra	01 - Foundation	02 - Fundamental	06 - Stretch	08 - Elite	33 - Element	44 - Primary	45 - Puddle	71 - Exclaim	74 - VeriGo	99 - Surge
Height Adjustable Options											
Spring Clip		●	●	●	●		●	●			
Ratchet		●	●							●	
Counterbal.							●	●		●	●
Short Bal.							●	●		●	●
Pneumatic		●	●				●	●			
Hand Crank										●	
Electric										●	●
Man. Ext. Ht.		●	●				●				

EH Electric Height

Electric height adjustability gives you the height range of the counterbalanced option, but is available in a wider variety of top shapes and sizes. The memory keypad remembers your four favorite heights. Available in both VeriGo and Surge.

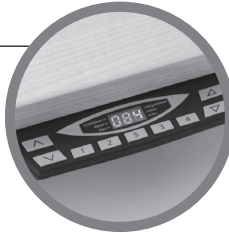

EX Manual Extended Height

This base has the ability to manually change height in 1" increments by removing and re-inserting its bolts. Table height range of 26-42". Available in Foundation (T-bases), Fundamental (T-bases), and Primary series (2" column only).

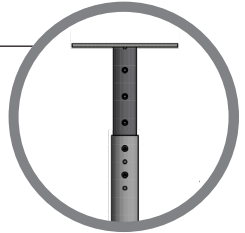

BL Counterbalanced

Need to get the most out of your height adjustable tables? The counterbalanced option is the way to go. Simply squeeze the small handle underneath and gently move the top to your desired height. With a range over 17" and unlimited choices in between, it's just that easy.

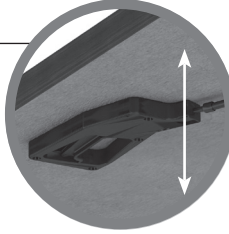

BLS Short Balanced

Go from coffee table height to standard height with the Short Balanced. Simply squeeze the small handle underneath and gently move the top to your desired height. Approximately 18-29".

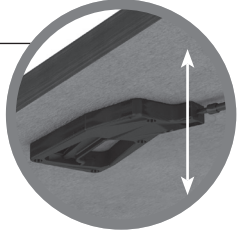

CR Hand Crank

Need the flexibility of infinite adjustability without the budget for counterbalanced bases? Our manual hand crank offers a cost-effective alternative. Only available in the VeriGo series and available on some nesting models.

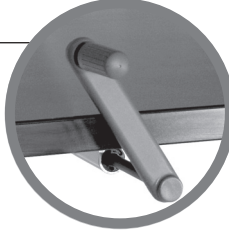

NU Pneumatic

Most square (max 36") and round (max 42") tables are available with pneumatic height

Base	NU
X-base	\$368
T-base	\$735

adjustability. 12" range in 1" increments. Upcharge is \$368 on X and disc bases. Also available on select T-bases in Foundation & Fundamental for \$735, including some nesting models.

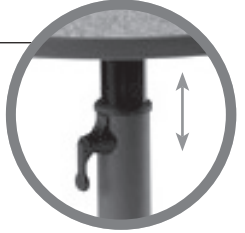

RA Ratchet

Ratchet height adjustability is available on select VeriGo, Foundation, & Fundamental tables. With a range of 9.45," the ratchet works in thirteen increments of .78". To reset to the lowest position, just lift past its highest point. Ratchet height adjustable bases are also available on some nesting tables.

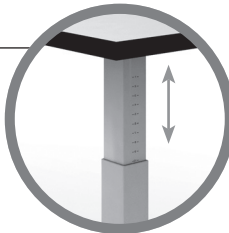

AH Spring Clip

A spring clip height adjustment mechanism is available on most tubular bases. See each series for availability. Height adjustment range is 26-32". Not available on tables larger than 42" round or 36" square.

Base	AH
X-base	\$132
T-base	\$263
4 columns	\$528

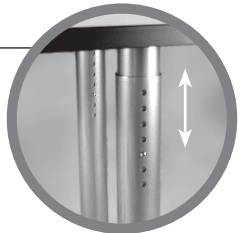

General Guidelines for Seating Capacities

- Allow about 30"/person
- Allow 48" for aisles between tables. ADA has 36" min.
- Allow 96"-120" between presenter and front row.
- Rooms with only one entrance are restricted to accommodate a maximum of 50 people (per fire code).
- Space required for single wheelchair passage is 36" min. and 60" min. for double wheelchair.
- Space required to turn a wheelchair is 60" dia.
- Newer wheelchair arms are designed to fit under standard 29"h tables (older models require an extra 2.5" of clearance)
- ADA Minimum table depth of 24".
- Ganging Wedges are not recommended for seating if top is not supported by a base.
- Capacities are based upon a 30" minimum width per seat. This chart is only a guideline which can vary based upon seating design and table layout.



Rectangle						Racetrack				Elliptical			
18 x 30	1												
18 x 36	1	30 x 36	2										
18 x 48	1	30 x 48	2 - 4										
										30 x 54	4		
18 x 60	2	30 x 60	4	48 x 60	6	36 x 60	4			30 x 60	4		
18 x 72	3	30 x 72	6	48 x 72	6 - 8	36 x 72	4					42 x 72	6
18 x 84	4	30 x 84	6	48 x 84	6 - 8	36 x 84	6					42 x 84	6 - 8
18 x 90	4	30 x 90	6	48 x 90	8	36 x 90	8					42 x 90	8
18 x 96	4 - 5	30 x 96	8	48 x 96	8 - 10	36 x 96	6 - 8					42 x 96	8 - 10
				48 x 120	10 - 12			54 x 120	10 - 12			42 x 120	10 - 12
				48 x 144	12			54 x 144	12			42 x 144	12
20 x 36	2												
20 x 48	2	36 x 48	2 - 4										
20 x 60	2 - 3	36 x 60	4 - 6	54 x 60	6					36 x 60	4		
20 x 72	3	36 x 72	6 - 8	54 x 72	8					36 x 72	4	48 x 72	6
20 x 84	4	36 x 84	6 - 8	54 x 84	8	42 x 84	6 - 8			36 x 84	6	48 x 84	6 - 8
20 x 90	4	36 x 90	8	54 x 90	8	42 x 90	8			36 x 90	8	48 x 90	8
20 x 96	4 - 5	36 x 96	8 - 10	54 x 96	8 - 10	42 x 96	8 - 10			36 x 96	6 - 8	48 x 96	8 - 10
				54 x 120	10 - 12	42 x 120	10 - 12	60 x 120	10 - 12			48 x 120	10 - 12
				54 x 144	12	42 x 144	12	60 x 144	12			48 x 144	12
24 x 36	1												
24 x 48	1												
24 x 60	2	42 x 60	6 - 8										
24 x 72	3	42 x 72	6 - 8	60 x 72	8								
24 x 84	4	42 x 84	6 - 8	60 x 84	8	48 x 84	6 - 8						
24 x 90	4	42 x 90	8	60 x 90	8	48 x 90	8						
24 x 96	4 - 5	42 x 96	8 - 10	60 x 96	8 - 10	48 x 96	8 - 10						
				42 x 120	10 - 12	48 x 120	10 - 12						
				42 x 144	12	48 x 144	12						
				60 x 120	10 - 12								
				60 x 144	12								

Square		Round	
24 x 24	2	24 x 24	2
30 x 30	2	30 x 30	2
36 x 36	4	36 x 36	3
42 x 42	4	42 x 42	4
48 x 48	4	48 x 48	4 - 5
54 x 54	4 - 8	54 x 54	5
60 x 60	4 - 8	60 x 60	6 - 7



D-shaped

24 x 36	1	42 x 60	5 - 7
24 x 48	1	42 x 72	5 - 7
24 x 60	2	42 x 84	5 - 7
24 x 72	3	42 x 90	7
24 x 84	3	42 x 96	7 - 9
24 x 90	3	48 x 60	5 - 7
24 x 96	2 - 3	48 x 72	5 - 7
30 x 48	2 - 3	48 x 84	5 - 7
30 x 60	3	48 x 90	7
30 x 72	5	48 x 96	7 - 9
30 x 84	5	54 x 54	4
30 x 90	5	54 x 60	6
30 x 96	7	54 x 72	8
36 x 48	2 - 3	54 x 84	8
36 x 60	3 - 5	54 x 90	8
36 x 72	5 - 7	54 x 96	8 - 10
36 x 84	5 - 7	54 x 120	10 - 12
36 x 90	7	54 x 144	12
36 x 96	7 - 9	60 x 60	6
		60 x 72	8
		60 x 84	8
		60 x 90	8
		60 x 96	8 - 10
		60 x 120	10 - 12
		60 x 144	12



Boat-shaped

30 x 42 x 84	6 - 8
30 x 42 x 90	8
30 x 42 x 96	8 - 10
36 x 48 x 84	6 - 8
36 x 48 x 90	8
36 x 48 x 96	8 - 10
36 x 48 x 120	10 - 12
36 x 48 x 144	12
48 x 54 x 120	10 - 12
48 x 54 x 144	12
54 x 60 x 120	10 - 12
54 x 60 x 144	12



Squircle

24 x 24	2
30 x 30	2
36 x 36	4
42 x 42	4
48 x 48	4



Half Round

18 x 36	1 - 2
24 x 48	2
30 x 60	3
36 x 72	4



Trapezoid

24 x 48	4 - 5
24 x 72	4 - 5
30 x 60	4 - 5
36 x 72	4 - 5

tableX

QS tableXPRESS

price list
Effective May 16, 2022

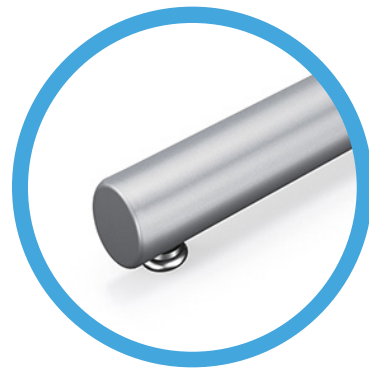



Need tables quickly? TableX can ship the following models in just 7-10 business days after receipt of clean order. We now offer silver powder coated Foundation T-bases, Surge disc or Primary square column bases, and you may choose any of our standard laminates and 3mm PVC edges to create the look your client is seeking. (Maximum order = 25 tables)

Foundation T, Surge Disc & Primary square column

Base Standards

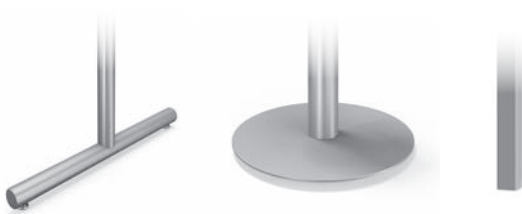

Standard Glides



Edge Options

Standard Finish Options

3mm PVC

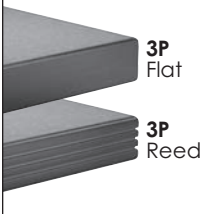

Laminates:
All standards are available. See pages 8-9 for current list.

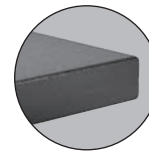

3mm Edges:
All standards are available. See page 10 for current list.

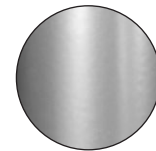

Bases:
37 Satin Silver

Top Shapes



Rectangle p.25

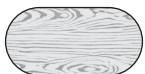

Racetrack p.26



Square p.25



Round p.25



Modesty Panels p.27



Rectangular with T-bases

Top Size	Base	Model Number	3P
24 x 36	Static	QS-01TC2436T20-3P	\$ 635
24 x 48	Static	QS-01TC2448T20-3P	689
24 x 60	Static	QS-01TC2460T20-3P	714
24 x 72	Static	QS-01TC2472T20-3P	762
24 x 84	Static	QS-01TC2484T20-3P	937
30 x 60	Static	QS-01TC3060T26-3P	767
30 x 72	Static	QS-01TC3072T26-3P	821
30 x 84	Static	QS-01TC3084T26-3P	1,034
36 x 60	Static	QS-01TC3660T26-3P	880
36 x 72	Static	QS-01TC3672T26-3P	931
36 x 84	Static	QS-01TC3684T26-3P	1,126



Rectangular with corner-mount square columns

Top Size	Base	Model Number	3P
24 x 36	Static	QS-44TC2436QC.2COR-3P	914
24 x 48	Static	QS-44TC2448QC.2COR-3P	969
24 x 60	Static	QS-44TC2460QC.2COR-3P	1,078
24 x 72	Static	QS-44TC2472QC.2COR-3P	1,125
30 x 60	Static	QS-44TC3060QC.2COR-3P	1,127
30 x 72	Static	QS-44TC3072QC.2COR-3P	1,180
36 x 60	Static	QS-44TC3660QC.2COR-3P	1,241
36 x 72	Static	QS-44TC3672QC.2COR-3P	1,291
36 x 84	Static	QS-44TC3684QC.2COR-3P	1,402



Square with thin round disc

Top Size	Base	Model Number	3P
30 x 30	Static	QS-99SQ3030D24-3P	824
30 x 30	Static	QS-99SQ3030D24-3P-SH.42	911
36 x 36	Static	QS-99SQ3636D24-3P	898
36 x 36	Static	QS-99SQ3636D24-3P-SH.42	985



Round with thin round disc

Top Size	Base	Model Number	3P
36 x 36	Static	QS-99RD36D24-3P	972
36 x 36	Static	QS-99RD36D24-3P-SH.42	1,059
42 x 42	Static	QS-99RD42D24-3P	1,087
42 x 42	Static	QS-99RD42D24-3P-SH.42	1,174

tableXpress



Square with corner mount square columns

Top Size	Base	Model Number	3P
30 x 30	Static	QS-44SQ3030QC.2COR-3P	920
36 x 36	Static	QS-44SQ3636QC.2COR-3P	995
42 x 42	Static	QS-44SQ4242QC.2COR-3P	1,082
48 x 48	Static	QS-44SQ4848QC.2COR-3P	1,183
60 x 60	Static	QS-44SQ6060QC.2COR-3P	1,506



Round with corner mount square columns

Top Size	Base	Model Number	3P
30 x 30	Static	QS-44RD30QC.2COR-3P	980
36 x 36	Static	QS-44RD36QC.2COR-3P	1,067
42 x 42	Static	QS-44RD42QC.2COR-3P	1,184
48 x 48	Static	QS-44RD48QC.2COR-3P	1,216
60 x 60	Static	QS-44RD60QC.2COR-3P	1,517



Racetrack with T-bases



Top Size	Base	Model Number	3P
36 x 72	Static	QS-01RT3672T26-3P	1,141
36 x 84	Static	QS-01RT3684T26-3P	1,460



Racetrack with disc bases

Top Size	Base	Model Number	3P
36 x 72	Static	QS-99RT3672D24-3P	1,906
36 x 72	Static	QS-99RT3672D24-3P-SH.42	2,079
36 x 84	Static	QS-99RT3684D24-3P	2,141
36 x 84	Static	QS-99RT3684D24-3P-SH.42	2,315



Adjustable height laptop table

Top Size	Base	Model Number	3P
12 x 18	Adjustable	QS-17RC1218C-AH-3P	780

Specifications:

Wilsonart D354-60 Designer White laminate
 D354 Designer White 3mm PVC edge
 or
 Wilsonart 7965K-12 Walnut Heights laminate
 Matching 3mm pvc edge



Laminate Modesty Panels

Size	Base	Model Number	3P
10 x 36	Static	QS-MP1036	131
10 x 48	Static	QS-MP1048	157
10 x 60	Static	QS-MP1060	182
10 x 72	Static	QS-MP1072	222
10 x 84	Static	QS-MP1084	247

tableXPRESS

tablex

ultra

00 ultra
price list
Effective May 16, 2022

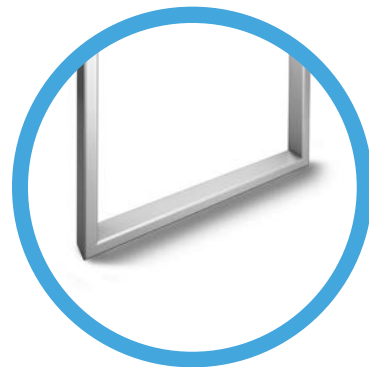



Sleek rectangular U-frame bases make a bold statement in our Ultra series. This stylish offering looks the part in a multitude of configurations, including a standing height option and locking casters.

Ultra Base Styles



U

Ultra Options

Standard Glides



Locking Casters



- LC Locking Casters**
can be added to any table for \$105 per set of four.
- FD Folding Bases**
are not available on Ultra tables.
- NE Nesting Tables**
are not available in the Ultra series.
- FT Flip Tops**
are not available on Ultra tables.
- FM Floor Mount Leveler Brackets**
are available for \$44 per table.
- OS Offset T-bases**
are not available on Ultra tables. Offset is not available on 18"d tables or 30"d nesting tables less than 60" wide.
- CH Chrome Finish**
is not available on Ultra tables.
- WM Wire Management**
Built-in wire management is not available on Ultra tables.
- MM IC Magnetic Wire Management Leg Covers**
Magnetically attaches onto any square leg and are \$67 each.
- SH Special Height**
can be added to any table:
+ \$145 per base
Maximum height is 41".

Special height tables with tops larger than 36x72" must be custom quoted.

Ultra Top Shapes

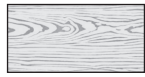

Rectangle
p.32



Round
p.33



Boat
p.33



D-shaped
p.34

Ultra Top Options

LT **Lightweight Tops**
can be added to any table for \$121.

GR **Grommets**
can be added to any table for \$42 each. To see specific locations, see page 217.

BB **Maple Butcher Block**
is 1.5" thick with food-grade clearcoat finish. Available in specific sizes with no grommets and clamp-on power only. Clamp-on power (Burelé) information can be found on page 209.

call for pricing.

Edge Options

(corresponds with 3 columns of pricing)

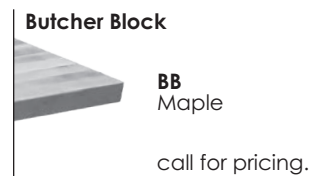
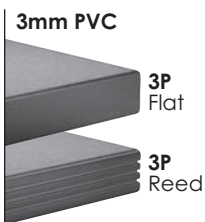

Rectangular with U-bases	Top Size	Base	Model Number	3P	3K	3W
	20 x 36	Static	00TC2036U18	\$ 835	\$ NA	\$1,079
	20 x 48	Static	00TC2048U18	890	NA	1,108
	20 x 60	Static	00TC2060U18	1,000	NA	1,222
	20 x 72	Static	00TC2072U18	1,047	NA	1,304
	20 x 84	Static	00TC2084U18	1,139	NA	1,434
	20 x 90	Static	00TC2090U18	1,193	NA	1,509
	20 x 96 *	Static	00TC2096U18	1,193	NA	1,524
	24 x 36	Static	00TC2436U22	860	NA	1,026
	24 x 48	Static	00TC2448U22	915	NA	1,116
	24 x 60	Static	00TC2460U22	1,025	NA	1,257
	24 x 72	Static	00TC2472U22	1,073	NA	1,339
	24 x 84	Static	00TC2484U22	1,164	NA	1,469
	24 x 90	Static	00TC2490U22	1,218	NA	1,544
	24 x 96 *	Static	00TC2496U22	1,218	NA	1,559
	30 x 36	Static	00TC3036U28	927	NA	1,110
	30 x 48	Static	00TC3048U28	994	NA	1,214
	30 x 60	Static	00TC3060U28	1,100	NA	1,352
	30 x 72	Static	00TC3072U28	1,152	NA	1,439
	30 x 84	Static	00TC3084U28	1,281	NA	1,611
	30 x 90	Static	00TC3090U28	1,350	NA	1,700
	30 x 96 *	Static	00TC3096U28	1,350	NA	1,715
	36 x 48	Static	00TC3648U34	1,073	NA	1,313
	36 x 60	Static	00TC3660U34	1,237	NA	1,516
	36 x 72	Static	00TC3672U34	1,289	NA	1,602
36 x 84	Static	00TC3684U34	1,399	NA	1,753	
36 x 90	Static	00TC3690U34	1,479	NA	1,856	
36 x 96 *	Static	00TC3696U34	1,479	NA	1,871	
42 x 60	Static	00TC4260U40	1,333	NA	1,633	
42 x 72	Static	00TC4272U40	1,430	NA	1,769	
42 x 84	Static	00TC4284U40	1,522	NA	1,900	
42 x 90	Static	00TC4290U40	1,611	NA	2,013	
42 x 96 *	Static	00TC4296U40	1,611	NA	2,028	
48 x 60	Static	00TC4860U46	1,384	NA	1,701	
48 x 72	Static	00TC4872U46	1,538	NA	1,900	
48 x 84	Static	00TC4884U46	1,547	NA	1,940	
48 x 90	Static	00TC4890U46	1,637	NA	2,054	
48 x 96 *	Static	00TC4896U46	1,637	NA	2,069	



Tables 36x72" and larger:  quote

* \$200 NET surcharge per order for oversized pallet

For Ultra table options, please reference pages 30-31.

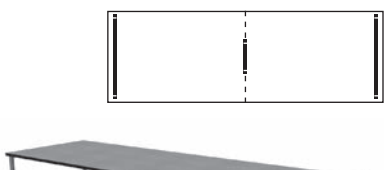
Top Size	Base	Model Number	3P	3K	3W	Rectangular with 3 U-bases
42 x 120	Static	00TC42120U40U18	\$ 2,534	\$ NA	\$ 3,048	
42 x 144	Static	00TC42144U40U18	2,719	NA	3,309	
48 x 120	Static	00TC48120U46U18	2,571	NA	3,100	
48 x 144	Static	00TC48144U46U18	2,758	NA	3,365	

LC SH ← ⊗
 N/A quote 3 bases:

Top Size	Base	Model Number	3P	3K	3W	Round with 4 U-bases
48 x 48	Static	00RD48U18(4)	\$ 1,743	NA	\$ 1,977	
54 x 54	Static	00RD54U18(4)	1,932	NA	2,209	
60 x 60	Static	00RD60U18(4)	1,960	NA	2,261	

LC SH ← ⊗
 N/A quote 4 bases:

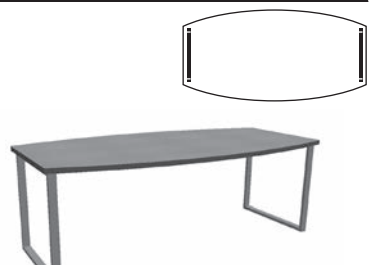
Top Size	Base	Model Number	3P	3K	3W	Boat-shaped with U-bases
30 x 42 x 84	Static	00BT3084U28	\$ 1,711	NA	\$ 2,068	
30 x 42 x 90	Static	00BT3090U28	1,840	NA	2,224	
30 x 42 x 96 *	Static	00BT3096U28	1,840	NA	2,240	
36 x 48 x 84	Static	00BT3684U34	1,863	NA	2,242	
36 x 48 x 90	Static	00BT3690U34	2,010	NA	2,419	
36 x 48 x 96 *	Static	00BT3696U34	2,010	NA	2,433	

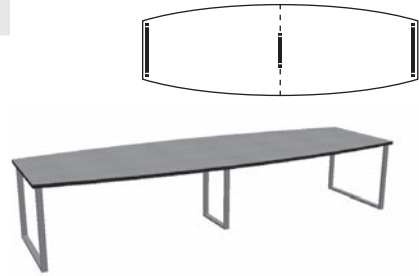
Top Size	Base	Model Number	3P	3K	3W	Boat-shaped with 3 U-bases
36 x 48 x 120	Static	00BT36120U34U18	\$ 3,041	NA	\$ 3,572	
36 x 48 x 144	Static	00BT36144U34U18	3,335	NA	3,954	

⊗ → LC SH
 3 bases: N/A quote

* \$200 NET surcharge per order for oversized pallet

For Ultra table options, please reference pages 30-31.

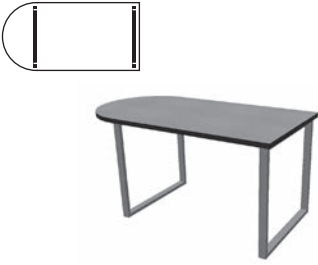
D-shaped with U-bases	Top Size	Base	Model Number	3P	3K	3W
	24 x 36	Static	00D2436U22	\$ 915	NA	\$ 1,073
	24 x 48	Static	00D2448U22	990	NA	1,185
	24 x 60	Static	00D2460U22	1,148	NA	1,380
	24 x 72	Static	00D2472U22	1,223	NA	1,491
	24 x 84	Static	00D2484U22	1,297	NA	1,603
	24 x 90	Static	00D2490U22	1,334	NA	1,658
	24 x 96 *	Static	00D2496U22	1,372	NA	1,714
	30 x 48	Static	00D3048U28	1,089	NA	1,304
	30 x 60	Static	00D3060U28	1,267	NA	1,520
	30 x 72	Static	00D3072U28	1,359	NA	1,651
30 x 84	Static	00D3084U28	1,453	NA	1,783	
30 x 90	Static	00D3090U28	1,499	NA	1,850	
30 x 96 *	Static	00D3096U28	1,545	NA	1,915	
36 x 48	Static	00D3648U34	1,189	NA	1,422	
36 x 60	Static	00D3660U34	1,384	NA	1,658	
36 x 72	Static	00D3672U34	1,497	NA	1,811	
36 x 84	Static	00D3684U34	1,608	NA	1,963	
36 x 90	Static	00D3690U34	1,664	NA	2,040	
36 x 96 *	Static	00D3696U34	1,719	NA	2,115	
42 x 72	Static	00D4272U40	1,852	NA	2,211	
42 x 84	Static	00D4284U40	1,883	NA	2,275	
42 x 90	Static	00D4290U40	1,957	NA	2,371	
42 x 96 *	Static	00D4296U40	2,030	NA	2,467	
48 x 72	Static	00D4872U46	1,919	NA	2,294	
48 x 84	Static	00D4884U46	1,919	NA	2,323	
48 x 90	Static	00D4890U46	1,993	NA	2,420	
48 x 96 *	Static	00D4896U46	2,068	NA	2,516	



Tables 36x72" and larger:  quote

* \$200 NET surcharge per order for oversized pallet

For Ultra table options, please reference pages 30-31.



For Ultra table options, please reference pages 30-31.

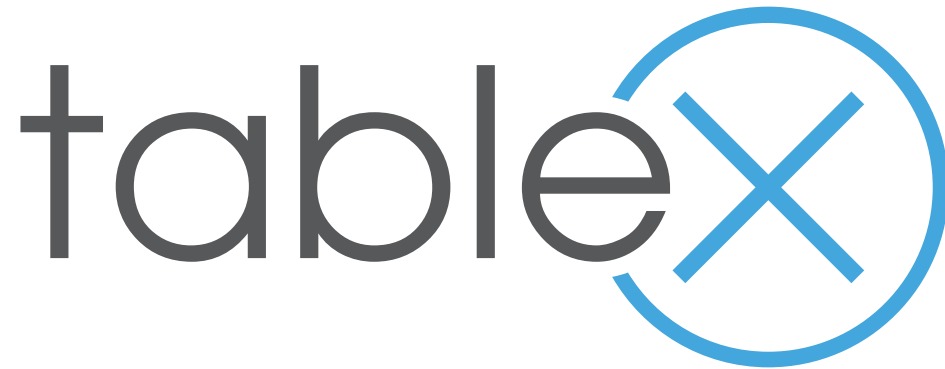

01 foundation
price list
Effective May 16, 2022

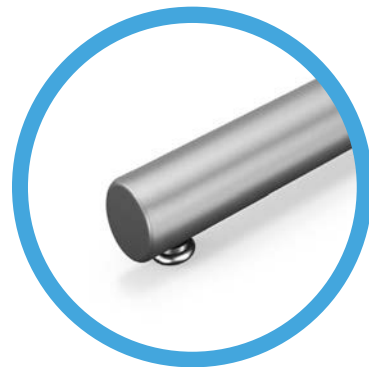





foundation

Any traditional table function can be accommodated with our competitively priced and cleanly styled Foundation tables. This series is perfect for any application and stands the test of time.

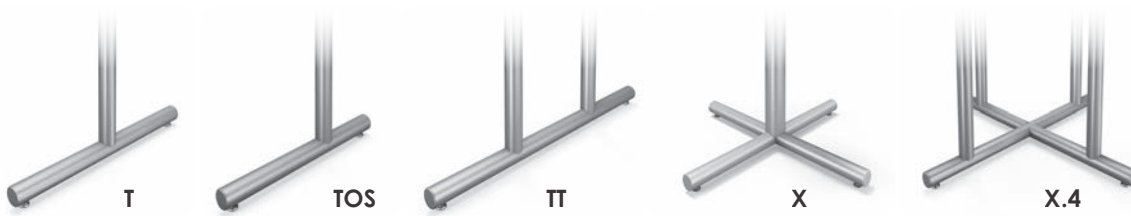
Foundation Base Styles



Foundation Options

- 

LC **Locking Casters** can be added to any table for \$105 per set of four.
- 

FT **Flip Tops** available on X-based tables and are priced with standard glides.
- 

SH **Special Height** can be added to any table:
 + \$68 per column for heights > 29"
 + \$37 per column for heights < 29"
 Special height tables with tops larger than 36x72" must be custom quoted.
- 

OS **Offset T-bases** available for \$37 per table. Offset is not available on 18"d tables or 30"d nesting tables less than 60" wide.
- FR** **Footring** available on standing height disc-bases for \$158 per base. Not available in chrome.
- BN** **Bullnose End** available on all Foundation bases for \$69 per table.
- FD** **Folding Bases** priced accordingly with standard glides.
- WM** **Wire Management** Built-in wire management is available for \$132 per column. Specify inside or outside of column.
- NE** **Nesting Tables** priced accordingly with locking casters.
- WM** **Wire Management Leg Covers 2"** snap onto any leg and are \$47 each.
- FM** **Floor Mount Leveler Brackets** are available for \$42 per table.
- PB** **Powerbox Mounting Plate** is available on disc & X-bases for \$95.

Foundation Height Adjustable Options

- NU Pneumatic** is available on X-bases for \$368 and on T-bases for \$735 per table. For height option details, see page 19.
- AH Spring Clip** is available on X-bases for \$132 and on T-bases for \$263 per table. For height option details, see page 19.
- RA Ratchet** is available on T-bases and nesting for \$482 per table. Available height adjustable finishes can be found on page 9.
- EX Manual Extended Height** is available on T-bases for \$195 per table. For height option details, see page 19.

Foundation Top Shapes

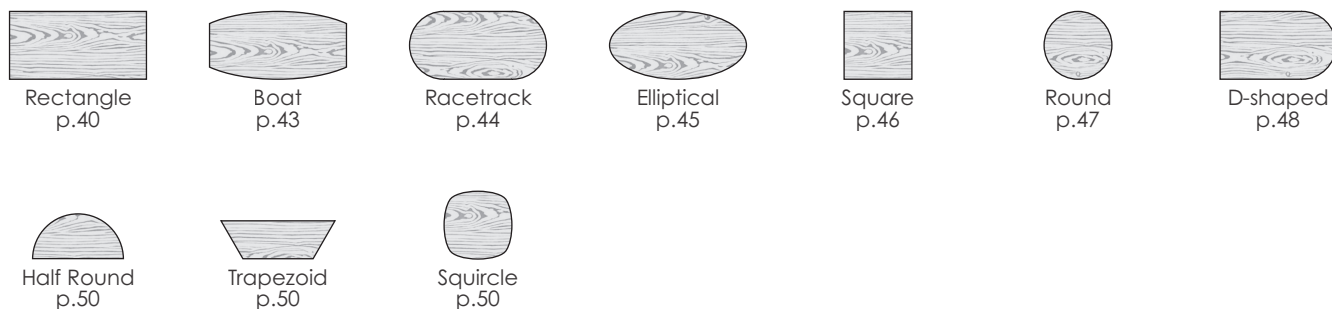

foundation





Foundation Top Options

- QG Quick-Connect Ganging Brackets** can be added to any table for \$42 (includes 4 connectors per table).
- RC 3" Radius Corners** can be added to any table for \$58.
- GR Grommets** can be added to any table for \$42 each. To see specific locations, see page 217.
- GN Ganging Plates & Knobs** can be added to most table shapes for \$42 (includes 2 plates & 8 knobs per table).
- LT Lightweight Tops** can be added to any square or rectangular table for \$121.

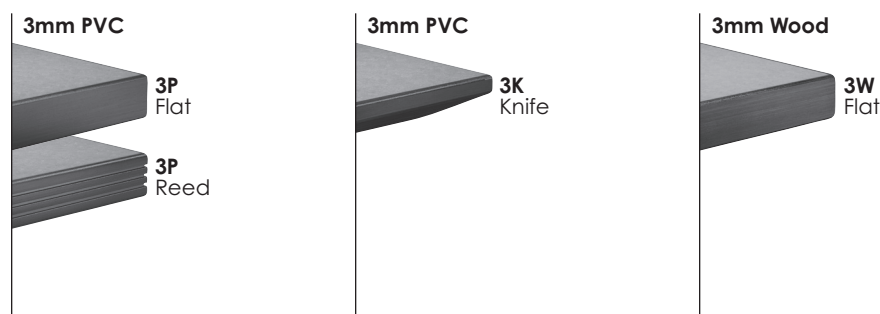
Foundation Edge Options

(corresponds with 3 columns of pricing)



Rectangular with T-bases	Top Size	Base	Model Number	3P	3K	3W
   	18 x 36	Static	01TC1836T16	\$ 591	\$ 642	\$ 737
		Nesting	01TC1836T18NE	1,252	1,302	1,395
	18 x 48	Static	01TC1848T16	633	700	812
		Folding	01TC1848T16FD	944	1,013	1,125
		Nesting	01TC1848T18NE	1,293	1,359	1,469
	18 x 60	Static	01TC1860T16	674	759	888
		Folding	01TC1860T16FD	999	1,084	1,213
		Nesting	01TC1860T18NE	1,334	1,417	1,543
	18 x 72	Static	01TC1872T16	716	816	962
		Folding	01TC1872T16FD	1,041	1,142	1,288
		Nesting	01TC1872T18NE	1,598	1,697	1,841
	18 x 84	Static	01TC1884T16	842	959	1,123
		Folding	01TC1884T16FD	1,082	1,201	1,363
		Nesting	01TC1884T18NE	1,638	1,755	1,915
	18 x 90	Static	01TC1890T16	882	1,017	1,183
		Folding	01TC1890T16FD	1,124	1,258	1,424
		Nesting	01TC1890T18NE	1,679	1,812	1,974
	18 x 96 *	Static	01TC1896T16	882	1,017	1,197
Folding		01TC1896T16FD	1,124	1,258	1,439	
Nesting		01TC1896T18NE	1,679	1,812	1,988	
20 x 36	Static	01TC2036T18	630	699	786	
	Nesting	01TC2036T20NE	1,295	1,361	1,447	
20 x 48	Static	01TC2048T18	685	775	876	
	Folding	01TC2048T18FD	998	1,087	1,188	
	Nesting	01TC2048T20NE	1,349	1,436	1,535	
20 x 60	Static	01TC2060T18	711	810	933	
	Folding	01TC2060T18FD	1,036	1,136	1,258	
	Nesting	01TC2060T20NE	1,373	1,470	1,591	
20 x 72	Static	01TC2072T18	759	876	1,015	
	Folding	01TC2072T18FD	1,083	1,202	1,340	
	Nesting	01TC2072T20NE	1,644	1,759	1,895	
20 x 84	Static	01TC2084T18	934	1,089	1,229	
	Folding	01TC2084T18FD	1,175	1,330	1,470	
	Nesting	01TC2084T20NE	1,733	1,885	2,023	
20 x 90	Static	01TC2090T18	989	1,165	1,305	
	Folding	01TC2090T18FD	1,230	1,406	1,545	
	Nesting	01TC2090T20NE	1,787	1,960	2,096	
20 x 96 *	Static	01TC2096T18	989	1,165	1,319	
	Folding	01TC2096T18FD	1,230	1,406	1,560	
	Nesting	01TC2096T20NE	1,787	1,960	2,111	

* \$200 NET surcharge per order for oversized pallet

For Foundation series table options, please reference pages 38-39.



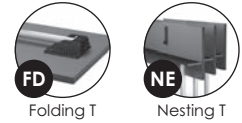

Top Size	Base	Model Number	3P	3K	3W	Rectangular with T-bases
24 x 36	Static	01TC2436T20	\$ 635	\$ 702	\$ 800	
	Nesting	01TC2436T22NE	1,295	1,361	1,457	
24 x 48	Static	01TC2448T20	689	779	889	
	Folding	01TC2448T20FD	1,001	1,091	1,202	
	Nesting	01TC2448T22NE	1,349	1,436	1,545	
24 x 60	Static	01TC2460T20	714	814	947	
	Folding	01TC2460T20FD	1,040	1,139	1,272	
	Nesting	01TC2460T22NE	1,373	1,470	1,601	
24 x 72	Static	01TC2472T20	762	880	1,028	
	Folding	01TC2472T20FD	1,087	1,205	1,353	
	Nesting	01TC2472T22NE	1,644	1,759	1,905	
24 x 84	Static	01TC2484T20	937	1,092	1,243	
	Folding	01TC2484T20FD	1,179	1,333	1,484	
	Nesting	01TC2484T22NE	1,733	1,885	2,032	
24 x 90	Static	01TC2490T20	992	1,169	1,317	
	Folding	01TC2490T20FD	1,233	1,410	1,559	
	Nesting	01TC2490T22NE	1,787	1,960	2,106	
24 x 96 *	Static	01TC2496T20	992	1,169	1,332	
	Folding	01TC2496T20FD	1,233	1,410	1,573	
	Nesting	01TC2496T22NE	1,787	1,960	2,120	
30 x 36	Static	01TC3036T26	679	762	863	
	Nesting	01TC3036T26NE	1,338	1,420	1,519	
30 x 48	Static	01TC3048T26	746	857	966	
	Folding	01TC3048T26FD	1,059	1,169	1,278	
	Nesting	01TC3048T26NE	1,404	1,514	1,621	
30 x 60	Static	01TC3060T26	767	887	1,019	
	Folding	01TC3060T26FD	1,092	1,212	1,344	
	Nesting	01TC3060T26NE	1,425	1,542	1,672	
30 x 72	Static	01TC3072T26	821	960	1,107	
	Folding	01TC3072T26FD	1,145	1,286	1,433	
	Nesting	01TC3072T26NE	1,700	1,838	1,982	
30 x 84	Static	01TC3084T26	1,034	1,225	1,362	
	Folding	01TC3084T26FD	1,274	1,466	1,604	
	Nesting	01TC3084T26NE	1,827	2,015	2,150	
30 x 90	Static	01TC3090T26	1,101	1,320	1,452	
	Folding	01TC3090T26FD	1,342	1,562	1,693	
	Nesting-Light	01TC3090T26NE-LT	2,109	N/A	2,474	
30 x 96 *	Static	01TC3096T26	1,101	1,320	1,467	
	Folding	01TC3096T26FD	1,342	1,562	1,708	
	Nesting-Light	01TC3096T26NE-LT	2,109	N/A	2,489	





foundation

* \$200 NET surcharge per order for oversized pallet



For Foundation series table options, please reference pages 38-39.

Rectangular with T-bases	Top Size	Base	Model Number	3P	3K	3W
   	36 x 48	Static	01TC3648T26	\$ 800	\$ 932	\$ 1,040
		Folding	01TC3648T26FD	1,112	1,245	1,353
		Nesting	01TC3648T26NE	1,583	1,713	1,819
	36 x 60	Static	01TC3660T26	880	1,045	1,159
		Folding	01TC3660T26FD	1,206	1,370	1,484
		Nesting	01TC3660T26NE	1,734	1,896	2,007
	36 x 72	Static	01TC3672T26	931	1,117	1,244
		Folding	01TC3672T26FD	1,256	1,441	1,569
		Nesting	01TC3672T26NE	1,810	1,991	2,116
	36 x 84	Static	01TC3684T26	1,126	1,355	1,480
		Folding	01TC3684T26FD	1,368	1,596	1,720
		Nesting-Light	01TC3684T26NE-LT	2,144	N/A	2,512
	36 x 90	Static	01TC3690T26	1,206	1,467	1,582
		Folding	01TC3690T26FD	1,447	1,708	1,823
		Nesting-Light	01TC3690T26NE-LT	2,253	N/A	2,648
	36 x 96 *	Static	01TC3696T26	1,206	1,467	1,596
		Folding	01TC3696T26FD	1,447	1,708	1,838
		Nesting-Light	01TC3696T26NE-LT	2,253	N/A	2,661



Rectangular with TT-bases	Top Size	Base	Model Number	3P	3K	3W
  	42 x 60	Static	01TC4260TT34	\$ 1,164	\$ 1,356	\$ 1,464
		Nesting	01TC4260TT34NE	2,196	2,385	2,490
	42 x 72	Static	01TC4272TT34	1,260	1,491	1,600
		Nesting	01TC4272TT34NE	2,291	2,516	2,622
	42 x 84	Static	01TC4284TT34	1,437	1,705	1,815
	42 x 90	Static	01TC4290TT34	1,526	1,830	1,927
	42 x 96 *	Static	01TC4296TT34	1,526	1,830	1,943
	48 x 60	Static	01TC4860TT36	1,190	1,393	1,507
		Nesting	01TC4860TT36NE	2,221	2,421	2,532
	48 x 72	Static	01TC4872TT36	1,342	1,607	1,705
		Nesting	01TC4872TT36NE	2,371	2,631	2,726
	48 x 84	Static	01TC4884TT36	1,437	1,705	1,830
	48 x 90	Static	01TC4890TT36	1,527	1,832	1,944
	48 x 96 *	Static	01TC4896TT36	1,527	1,832	1,959

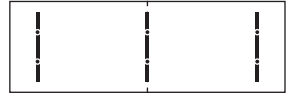

* \$200 NET surcharge per order for oversized pallet

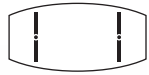

For Foundation series table options, please reference pages 38-39.

Top Size	Base	Model Number	3P	3K	3W	Rectangular with 3 TT-bases
42 x 120	Static	01TC42120TT34(3)	\$ 2,204	\$ 2,656	\$ 2,717	 
42 x 144	Static	01TC42144TT34(3)	2,389	2,914	2,979	
48 x 120	Static	01TC48120TT36(3)	2,216	2,672	2,744	
48 x 144	Static	01TC48144TT36(3)	2,403	2,933	3,009	

LC CH SH ← ⊗
 N/A +158 quote 3 bases:

Top Size	Base	Model Number	3P	3K	3W	Boat-shaped with T-bases
30 x 42 x 84	Static	01BT3084T26	\$ 1,462	\$ 1,826	\$ 1,820	 
30 x 42 x 90	Static	01BT3090T26	1,591	2,007	1,977	
30 x 42 x 96 *	Static	01BT3096T26	1,591	2,007	1,991	

Top Size	Base	Model Number	3P	3K	3W	Boat-shaped with TT-bases
36 x 48 x 84	Static	01BT3684TT34	\$ 1,803	\$ 2,218	\$ 2,182	 
36 x 48 x 90	Static	01BT3690TT34	1,950	2,424	2,359	
36 x 48 x 96 *	Static	01BT3696TT34	1,950	2,424	2,373	

Top Size	Base	Model Number	3P	3K	3W	Boat-shaped with 3 TT-bases
36 x 48 x 120	Static	01BT36120TT36(3)	\$ 2,737	\$ 3,400	\$ 3,266	 
36 x 48 x 144	Static	01BT36144TT36(3)	3,030	3,812	3,648	

LC CH SH ← ⊗
 N/A +158 quote 3 bases:



* \$200 NET surcharge per order for oversized pallet

For Foundation series table options, please reference pages 38-39.

foundation

Race-track with T-bases	Top Size	Base	Model Number	3P	3K	3W
    <p>FD Folding T NE Nesting T</p>	36 x 60	Static	01RT3660T26	\$ 1,141	\$ 1,409	\$ 1,406
		Nesting	01RT3660T26NE	1,918	2,180	2,178
	36 x 72	Static	01RT3672T26	1,141	1,409	1,436
		Folding	01RT3672T26FD	1,465	1,734	1,761
		Nesting	01RT3672T26NE	1,989	2,253	2,279
	36 x 84	Static	01RT3684T26	1,460	1,822	1,809
		Folding	01RT3684T26FD	1,700	2,064	2,049
	36 x 90	Static	01RT3690T26	1,591	2,007	1,968
		Folding	01RT3690T26FD	1,833	2,249	2,210
	36 x 96 *	Static	01RT3696T26	1,591	2,007	1,983
	Folding	01RT3696T26FD	1,833	2,249	2,224	

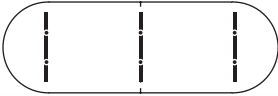
Race-track with TT-bases	Top Size	Base	Model Number	3P	3K	3W
 	42 x 84	Static	01RT4284TT34	\$ 1,673	\$ 2,035	\$ 2,030
	42 x 90	Static	01RT4290TT34	1,804	2,220	2,190
	42 x 96 *	Static	01RT4296TT34	1,804	2,220	2,204
	48 x 84	Static	01RT4884TT34	1,950	2,424	2,344
	48 x 90	Static	01RT4890TT34	1,950	2,424	2,359
	48 x 96 *	Static	01RT4896TT34	1,950	2,424	2,373

Race-track with 3 TT-bases	Top Size	Base	Model Number	3P	3K	3W
  <div style="display: flex; align-items: center; margin-top: 10px;"> ⊗ → <div style="display: flex; gap: 10px;"> <div style="border: 1px solid black; border-radius: 50%; padding: 2px;">LC</div> <div style="border: 1px solid black; border-radius: 50%; padding: 2px;">CH</div> <div style="border: 1px solid black; border-radius: 50%; padding: 2px;">SH</div> </div> <div style="margin-left: 10px; font-size: 0.8em;"> 3 bases: N/A +158 quote </div> </div>	42 x 120	Static	01RT42120TT34(3)	\$ 2,721	\$ 3,378	\$ 3,241
	42 x 144	Static	01RT42144TT34(3)	3,011	3,785	3,619
	48 x 120	Static	01RT48120TT36(3)	2,737	3,401	3,267
	48 x 144	Static	01RT48144TT36(3)	3,031	3,813	3,649

* \$200 NET surcharge per order for oversized pallet

For Foundation series table options, please reference pages 38-39.

Top Size	Base	Model Number	3P	3K	3W	Elliptical with T-bases
30 x 54	Static	01EL3054T22	\$ 890	\$ 1,059	\$ 1,095	
30 x 60	Static	01EL3060T22	934	1,122	1,155	
36 x 60	Static	01EL3660T26	1,033	1,258	1,275	
36 x 72	Static	01EL3672T26	1,141	1,409	1,417	
36 x 84	Static	01EL3684T26	1,337	1,651	1,648	
36 x 90	Static	01EL3690T26	1,445	1,802	1,778	
36 x 96 *	Static	01EL3696T26	1,445	1,802	1,790	

Top Size	Base	Model Number	3P	3K	3W	Elliptical with TT-bases
42 x 72	Static	01EL4272TT26	\$ 1,394	\$ 1,708	\$ 1,694	
42 x 84	Static	01EL4284TT26	1,601	1,963	1,936	
42 x 90	Static	01EL4290TT26	1,735	2,151	2,095	
42 x 96 *	Static	01EL4296TT26	1,735	2,151	2,107	
48 x 72	Static	01EL4872TT30	1,540	1,897	1,862	
48 x 84	Static	01EL4884TT30	1,917	2,390	2,291	
48 x 90	Static	01EL4890TT30	1,917	2,390	2,302	
48 x 96 *	Static	01EL4896TT30	1,917	2,390	2,315	



Top Size	Base	Model Number	3P	3K	3W	Elliptical with 3 TT-bases
42 x 120	Static	01EL42120TT34(3)	\$ 2,721	\$ 3,378	\$ 3,199	
42 x 144	Static	01EL42144TT34(3)	3,011	3,785	3,565	
48 x 120	Static	01EL48120TT36(3)	2,737	3,401	3,229	
48 x 144	Static	01EL48144TT36(3)	3,031	3,813	3,599	



LC CH SH ← ⊗
 N/A +158 quote 3 bases:



* \$200 NET surcharge per order for oversized pallet

For Foundation series table options, please reference pages 38-39.



foundation

Square with X-base		Top Size	Base	Model Number	3P	3K	3W
   <p>Flip Top X</p>	24 x 24	Static	01SQ2424X22	\$ 509	\$ 554	\$ 638	
		Flip Top	01SQ2424X22FT	664	709	793	
	30 x 30	Static	01SQ3030X26	577	647	743	
		Flip Top	01SQ3030X26FT	732	803	898	
	36 x 36	Static	01SQ3636X32	674	773	876	
		Flip Top	01SQ3636X32FT	829	929	1,032	
	42 x 42	Static	01SQ4242X36	777	912	1,018	
		Flip Top	01SQ4242X36FT	1,008	1,143	1,250	
	48 x 48	Static	01SQ4848X38	901	1,077	1,183	



Square with 4-column X-base		Top Size	Base	Model Number	3P	3K	3W
 	54 x 54	Static	01SQ5454X36.4	\$ 1,260	\$ 1,481	\$ 1,582	
	60 x 60	Static	01SQ6060X42.4	1,427	1,698	1,792	











 X.4: N/A +272

Square with TT-bases		Top Size	Base	Model Number	3P	3K	3W
   <p>Nesting TT</p>	48 x 48	Static	01SQ4848TT34	\$ 1,119	\$ 1,294	\$ 1,400	
		Nesting	01SQ4848TT34NE	2,152	2,323	2,427	

For Foundation series table options, please reference pages 38-39.

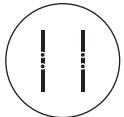

Top Size	Base	Model Number	3P	3K	3W	Round with X-base
24 x 24	Static	01RD24X22	\$ 546	\$ 607	\$ 655	   Flip Top X
	Flip Top	01RD24X22FT	702	763	810	
30 x 30	Static	01RD30X26	637	731	776	
	Flip Top	01RD30X26FT	792	887	932	
36 x 36	Static	01RD36X30	745	874	916	
	Flip Top	01RD36X30FT	900	1,029	1,071	
42 x 42	Static	01RD42X32	863	1,039	1,069	
	Flip Top	01RD42X32FT	1,094	1,270	1,300	
48 x 48	Static	01RD48X36	912	1,101	1,145	

Top Size	Base	Model Number	3P	3K	3W	Round with 4-column X-base
54 x 54	Static	01RD54X32.4	\$ 1,310	\$ 1,574	\$ 1,585	   CH N/A SH +272 X.4:
60 x 60	Static	01RD60X36.4	1,397	1,672	1,698	

Top Size	Base	Model Number	3P	3K	3W	Round with TT-bases
48 x 48	Static	01RD48TT26	\$ 1,082	\$ 1,271	\$ 1,315	   Folding TT
	Nesting	01RD48TT26NE	2,115	2,300	2,344	
54 x 54	Static	01RD54TT30	1,310	1,574	1,585	
	Nesting	01RD54TT30NE	2,339	2,598	2,609	
60 x 60	Static	01RD60TT34	1,371	1,646	1,672	
	Nesting	01RD60TT34NE	2,399	2,669	2,694	





For Foundation series table options, please reference pages 38-39.



foundation

D-shaped with T-bases	Top Size	Base	Model Number	3P	3K	3W
 	24 x 36	Static	01D2436T20	\$ 688	\$ 777	\$ 847
		Nesting	01D2436T20NE	1,349	1,436	1,503
	24 x 48	Static	01D2448T20	763	882	958
		Nesting	01D2448T20NE	1,421	1,538	1,612
	24 x 60	Static	01D2460T20	837	986	1,069
		Nesting	01D2460T20NE	1,495	1,641	1,721
	24 x 72	Static	01D2472T20	912	1,090	1,181
		Nesting	01D2472T20NE	1,607	1,782	1,872
 Nesting T	24 x 84	Static	01D2484T20	1,070	1,278	1,376
		Nesting	01D2484T20NE	1,864	2,068	2,163
	24 x 90	Static	01D2490T20	1,107	1,331	1,432
		Nesting	01D2490T20NE	1,900	2,119	2,218
	24 x 96 *	Static	01D2496T20	1,145	1,383	1,488
		Nesting	01D2496T20NE	1,937	2,171	2,273
	30 x 48	Static	01D3048T26	840	990	1,055
		Nesting	01D3048T26NE	1,498	1,644	1,708
	30 x 60	Static	01D3060T26	934	1,120	1,187
		Nesting	01D3060T26NE	1,589	1,772	1,837
	30 x 72	Static	01D3072T26	1,027	1,250	1,318
		Nesting	01D3072T26NE	1,720	1,940	2,006
	30 x 84	Static	01D3084T26	1,205	1,465	1,535
		Nesting	01D3084T26NE	1,995	2,251	2,319
	30 x 90	Static	01D3090T26	1,251	1,530	1,601
		Nesting-Light	01D3090T26NE-LT	2,315	N/A	N/A
	30 x 96 *	Static	01D3096T26	1,297	1,594	1,667
		Nesting-Light	01D3096T26NE-LT	2,378	N/A	N/A
	36 x 48	Static	01D3648T26	915	1,094	1,148
		Nesting	01D3648T26NE	1,570	1,746	1,799
	36 x 60	Static	01D3660T26	1,027	1,250	1,300
		Nesting	01D3660T26NE	1,766	1,985	2,034
	36 x 72	Static	01D3672T26	1,139	1,406	1,453
		Nesting	01D3672T26NE	1,987	2,251	2,296
	36 x 84	Static	01D3684T26	1,334	1,647	1,690
		Nesting-Light	01D3684T26NE-LT	2,429	N/A	N/A
	36 x 90	Static	01D3690T26	1,391	1,726	1,766
		Nesting-Light	01D3690T26NE-LT	2,506	N/A	N/A
	36 x 96 *	Static	01D3696T26	1,446	1,803	1,842
		Nesting-Light	01D3696T26NE-LT	2,582	N/A	N/A

* \$200 NET surcharge per order for oversized pallet

For Foundation series table options, please reference pages 38-39.

Top Size	Base	Model Number	3P	3K	3W	D-shaped with TT-bases	
42 x 60	Static	01D4260TT34	\$ 1,683	\$ 2,083	\$ 2,012	 	
	Nesting	01D4260TT34NE	2,704	3,097	3,028		
42 x 72	Static	01D4272TT34	1,683	2,083	2,042		
	Nesting	01D4272TT34NE	2,704	3,097	3,057		
42 x 84	Static	01D4284TT34	1,798	2,211	2,190		
42 x 90	Static	01D4290TT34	1,872	2,314	2,285		
42 x 96 *	Static	01D4296TT34	1,945	2,417	2,382		
48 x 60	Static	01D4860TT36	1,725	2,140	2,069		  
	Nesting	01D4860TT36NE	2,745	3,154	3,084		
48 x 72	Static	01D4872TT36	1,725	2,140	2,099		
	Nesting	01D4872TT36NE	2,745	3,154	3,113		
48 x 84	Static	01D4884TT36	1,809	2,225	2,213		
48 x 90	Static	01D4890TT36	1,883	2,329	2,309		
48 x 96 *	Static	01D4896TT36	1,957	2,433	2,406		

Top Size	Base	Model Number	3P	3K	3W	D-shaped with 4-column X-base
54 x 54	Static	01D5454X36.4	\$ 1,630	\$ 1,999	\$ 1,974	 
60 x 60	Static	01D6060X42.4	1,680	2,052	2,037	

CH	SH	←	⊗
N/A	+272	X.4:	

* \$200 NET surcharge per order for oversized pallet

For Foundation series table options, please reference pages 38-39.

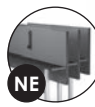
Half Round with T-bases	Top Size	Base	Model Number	3P	3K	3W
 	18 x 36	Static	01HR1836T16	\$ 696	\$ 789	\$ 833
	24 x 48	Static	01HR2448T16	763	884	945
		Nesting	01HR2448T16NE	1,421	1,540	1,600
	30 x 60	Static	01HR3060T20	932	1,119	1,169
		Nesting	01HR3060T22NE	1,587	1,770	1,819
	36 x 72	Static	01HR3672T26	1,138	1,404	1,433
		Nesting	01HR3672T26NE	1,915	2,176	2,203

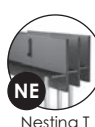
Trapezoid with T-bases	Top Size	Base	Model Number	3P	3K	3W
 	24 x 48	Static	01TZ2448T18	\$ 753	\$ 870	\$ 935
	24 x 72	Static	01TZ2472T18	942	1,134	1,218
		Nesting	01TZ2472T18NE	1,596	1,785	1,868
	30 x 60	Static	01TZ3060T22	882	1,049	1,115
		Nesting	01TZ3060T22NE	1,539	1,703	1,767
	36 x 72	Static	01TZ3672T26	1,110	1,368	1,403
		Nesting	01TZ3672T26NE	1,888	2,140	2,175

Squircle with X-base	Top Size	Base	Model Number	3P	3K	3W
	24 x 24	Static	01SL24X22	\$ 719	\$ 849	\$ 870
		Flip Top	01SL24X22FT	874	1,004	1,025
	30 x 30	Static	01SL30X26	783	935	969
		Flip Top	01SL30X26FT	938	1,090	1,124
	36 x 36	Static	01SL36X32	867	1,044	1,089
		Flip Top	01SL36X32FT	1,022	1,200	1,245
	42 x 42	Static	01SL42X36	952	1,157	1,210
		Flip Top	01SL42X36FT	1,183	1,388	1,442
	48 x 48	Static	01SL48X38	1,058	1,295	1,354

For Foundation series table options, please reference pages 38-39.

For Foundation series table options, please reference pages 38-39.

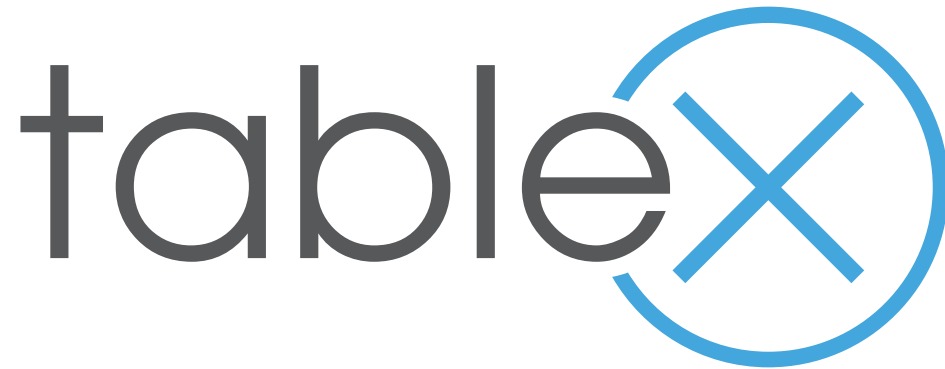

02 fundamental
price list
Effective May 16, 2022





Large installations often dictate the need for a durable, versatile, and budget conscious table option. Fundamental meets these needs in addition to making installations easy.

fundamental

Fundamental Base Styles

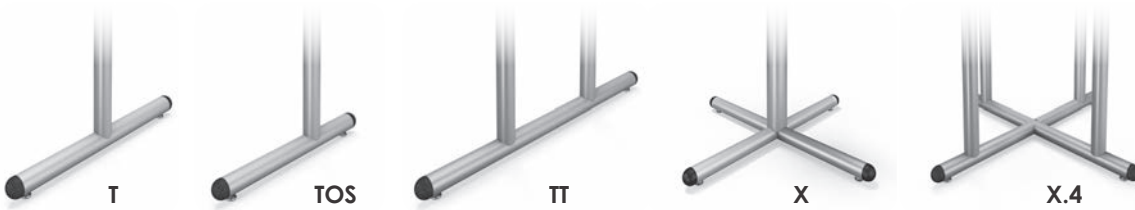

Fundamental Options

<p>Standard Glides</p> 	<p>LC Locking Casters can be added to any table for \$105 per set of four.</p>	<p>OS Offset T-bases available for \$37 per table. Offset is not available on 18" d tables or 30" d nesting tables less than 60" wide.</p>	<p>FM Floor Mount Leveler Brackets are available for \$42 per table.</p>
<p>Locking Casters</p> 	<p>CCG Concealed Casters available on one T-base for \$130 per table. Standard glides on opposite base.</p>	<p>CH Chrome Finish available for \$120 on most models. Upcharge for disc bases is \$462.</p>	<p>SH Special Height can be added to any table: + \$68 per column for heights > 29" + \$37 per column for heights < 29" Special height tables with tops larger than 36x72" must be custom quoted.</p>
<p>Concealed Casters</p> 	<p>FD Folding Bases priced accordingly with standard glides.</p> <p>NE Nesting Tables priced accordingly with locking casters.</p> <p>FI Flip Tops available on X-based tables and are priced with standard glides.</p>	<p>WM Wire Management Built-in wire management is available for \$132 per column. Specify inside or outside of column.</p> <p>WM/LC Wire Management Leg Covers 2" snap onto any leg and are \$47 each.</p>	<p>FR Footring available on standing height disc-bases for \$158 per base. Not available in chrome.</p> <p>PB Powerbox Mounting Plate is available on disc & X-bases for \$95.</p>

Fundamental Height Adjustable Options

- NU Pneumatic** is available on X-bases for \$368 and on T-bases for \$735 per table. For height option details, see page 19.
- AH Spring Clip** is available on X-bases for \$132 and on T-bases for \$263 per table. For height option details, see page 19.
- RA Ratchet** is available on T-bases and nesting for \$482 per table. Available height adjustable finishes can be found on page 9.
- EX Manual Extended Height** is available on T-bases for \$195 per table. For height option details, see page 19.

Fundamental Top Shapes

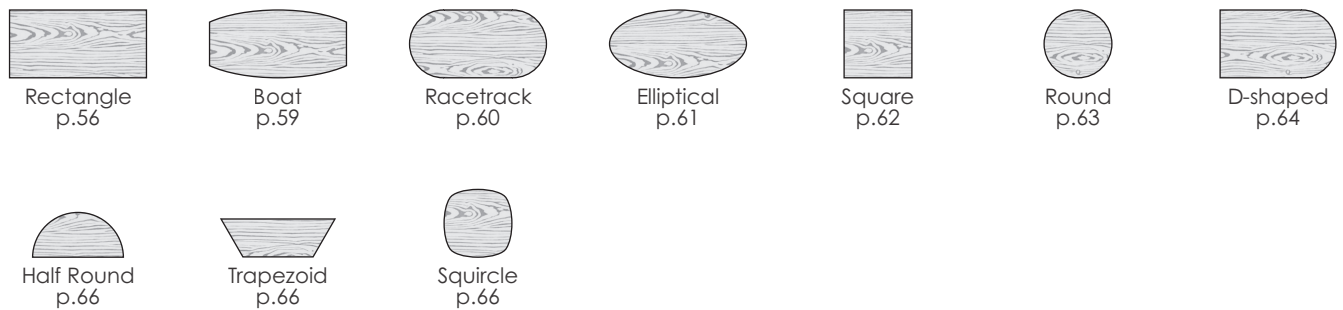

fundamental





Fundamental Top Options

- QG Quick-Connect Ganging Brackets** can be added to any table for \$42 (includes 4 connectors per table).
- RC 3" Radius Corners** can be added to any table for \$58.
- GR Grommets** can be added to any table for \$42 each. To see specific locations, see page 217.
- GN Ganging Plates & Knobs** can be added to most table shapes for \$42 (includes 2 plates and 8 knobs per table).
- LT Lightweight Tops** can be added to any square or rectangular table for \$121.

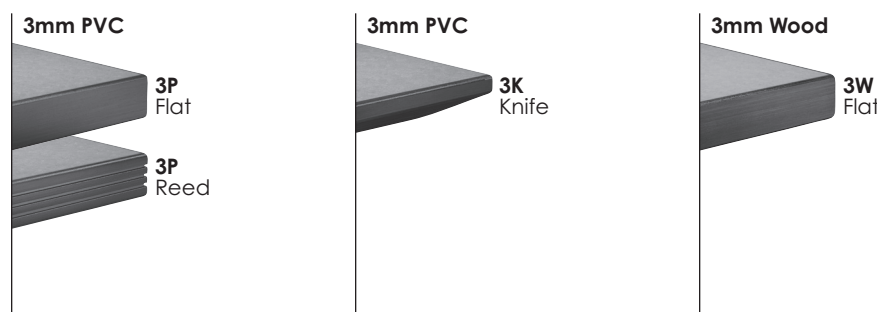
Fundamental Edge Options





(corresponds with 3 columns of pricing)



Rectangular with T-bases	Top Size	Base	Model Number	3P	3K	3W
   	18 x 36	Static	O2TC1836T16	\$ 581	\$ 633	\$ 727
		Nesting	O2TC1836T18NE	1,243	1,293	1,386
	18 x 48	Static	O2TC1848T16	623	691	803
		Folding	O2TC1848T16FD	936	1,004	1,116
		Nesting	O2TC1848T18NE	1,284	1,351	1,460
	18 x 60	Static	O2TC1860T16	665	749	878
		Folding	O2TC1860T16FD	991	1,075	1,204
		Nesting	O2TC1860T18NE	1,325	1,407	1,535
	18 x 72	Static	O2TC1872T16	706	808	954
		Folding	O2TC1872T16FD	1,032	1,133	1,279
		Nesting	O2TC1872T18NE	1,589	1,689	1,832
	18 x 84	Static	O2TC1884T16	832	951	1,113
		Folding	O2TC1884T16FD	1,074	1,191	1,355
		Nesting	O2TC1884T18NE	1,630	1,746	1,906
	18 x 90	Static	O2TC1890T16	874	1,008	1,174
		Folding	O2TC1890T16FD	1,115	1,250	1,415
		Nesting	O2TC1890T18NE	1,671	1,803	1,965
	18 x 96 *	Static	O2TC1896T16	874	1,008	1,189
		Folding	O2TC1896T16FD	1,115	1,250	1,430
		Nesting	O2TC1896T18NE	1,671	1,803	1,980
	20 x 36	Static	O2TC2036T18	622	689	777
		Nesting	O2TC2036T20NE	1,287	1,353	1,439
	20 x 48	Static	O2TC2048T18	677	766	867
		Folding	O2TC2048T18FD	990	1,079	1,180
Nesting		O2TC2048T20NE	1,340	1,427	1,526	
20 x 60	Static	O2TC2060T18	702	802	924	
	Folding	O2TC2060T18FD	1,027	1,127	1,250	
	Nesting	O2TC2060T20NE	1,364	1,462	1,583	
20 x 72	Static	O2TC2072T18	749	868	1,005	
	Folding	O2TC2072T18FD	1,075	1,193	1,331	
	Nesting	O2TC2072T20NE	1,635	1,751	1,886	
20 x 84	Static	O2TC2084T18	924	1,080	1,221	
	Folding	O2TC2084T18FD	1,166	1,321	1,461	
	Nesting	O2TC2084T20NE	1,725	1,877	2,014	
20 x 90	Static	O2TC2090T18	979	1,157	1,295	
	Folding	O2TC2090T18FD	1,221	1,398	1,537	
	Nesting	O2TC2090T20NE	1,778	1,951	2,088	
20 x 96 *	Static	O2TC2096T18	979	1,157	1,310	
	Folding	O2TC2096T18FD	1,221	1,398	1,551	
	Nesting	O2TC2096T20NE	1,778	1,951	2,103	





* \$200 NET surcharge per order for oversized pallet



For Fundamental series table options, please reference pages 54-55.

Top Size	Base	Model Number	3P	3K	3W	Rectangular with T-bases
24 x 36	Static	02TC2436T20	\$ 625	\$ 693	\$ 791	   
	Nesting	02TC2436T22NE	1,287	1,353	1,448	
24 x 48	Static	02TC2448T20	681	770	880	
	Folding	02TC2448T20FD	993	1,082	1,193	
	Nesting	02TC2448T22NE	1,340	1,427	1,537	
24 x 60	Static	02TC2460T20	706	805	938	
	Folding	02TC2460T20FD	1,032	1,130	1,264	
	Nesting	02TC2460T22NE	1,364	1,462	1,592	
24 x 72	Static	02TC2472T20	753	871	1,019	
	Folding	02TC2472T20FD	1,078	1,196	1,344	
	Nesting	02TC2472T22NE	1,635	1,751	1,897	
24 x 84	Static	02TC2484T20	929	1,084	1,234	
	Folding	02TC2484T20FD	1,170	1,325	1,475	
	Nesting	02TC2484T22NE	1,725	1,877	2,024	
24 x 90	Static	02TC2490T20	983	1,160	1,309	
	Folding	02TC2490T20FD	1,225	1,401	1,550	
	Nesting	02TC2490T22NE	1,778	1,951	2,097	
24 x 96 *	Static	02TC2496T20	983	1,160	1,323	
	Folding	02TC2496T20FD	1,225	1,401	1,565	
	Nesting	02TC2496T22NE	1,778	1,951	2,112	
30 x 36	Static	02TC3036T26	669	753	853	
	Nesting	02TC3036T26NE	1,330	1,412	1,510	
30 x 48	Static	02TC3048T26	738	848	958	
	Folding	02TC3048T26FD	1,050	1,161	1,270	
	Nesting	02TC3048T26NE	1,396	1,505	1,612	
30 x 60	Static	02TC3060T26	759	878	1,011	
	Folding	02TC3060T26FD	1,084	1,203	1,336	
	Nesting	02TC3060T26NE	1,417	1,533	1,664	
30 x 72	Static	02TC3072T26	811	952	1,099	
	Folding	02TC3072T26FD	1,137	1,277	1,423	
	Nesting	02TC3072T26NE	1,692	1,830	1,973	
30 x 84	Static	02TC3084T26	1,024	1,216	1,354	
	Folding	02TC3084T26FD	1,266	1,458	1,595	
	Nesting	02TC3084T26NE	1,819	2,007	2,141	
30 x 90	Static	02TC3090T26	1,092	1,312	1,443	
	Folding	02TC3090T26FD	1,334	1,553	1,685	
	Nesting-Light	02TC3090T26NE-LT	2,100	N/A	2,466	
30 x 96 *	Static	02TC3096T26	1,092	1,312	1,458	
	Folding	02TC3096T26FD	1,334	1,553	1,699	
	Nesting-Light	02TC3096T26NE-LT	2,100	N/A	2,481	

* \$200 NET surcharge per order for oversized pallet



For Fundamental series table options, please reference pages 54-55.

Rectangular with T-bases	Top Size	Base	Model Number	3P	3K	3W
  <div style="display: flex; justify-content: space-around; margin-top: 20px;"> <div style="text-align: center;">  <p>FD Folding T</p> </div> <div style="text-align: center;">  <p>NE Nesting T</p> </div> </div>	36 x 48	Static	02TC3648T26	\$ 791	\$ 923	\$ 1,032
		Folding	02TC3648T26FD	1,104	1,235	1,343
		Nesting	02TC3648T26NE	1,574	1,705	1,811
	36 x 60	Static	02TC3660T26	872	1,036	1,150
		Folding	02TC3660T26FD	1,197	1,361	1,475
		Nesting	02TC3660T26NE	1,726	1,887	1,999
	36 x 72	Static	02TC3672T26	922	1,107	1,235
		Folding	02TC3672T26FD	1,248	1,433	1,561
		Nesting	02TC3672T26NE	1,801	1,983	2,108
	36 x 84	Static	02TC3684T26	1,118	1,347	1,470
		Folding	02TC3684T26FD	1,358	1,588	1,712
		Nesting-Light	02TC3684T26NE-LT	2,135	N/A	2,504
	36 x 90	Static	02TC3690T26	1,197	1,458	1,573
		Folding	02TC3690T26FD	1,438	1,699	1,815
		Nesting-Light	02TC3690T26NE-LT	2,244	N/A	2,639
	36 x 96 *	Static	02TC3696T26	1,197	1,458	1,588
		Folding	02TC3696T26FD	1,438	1,699	1,830
		Nesting-Light	02TC3696T26NE-LT	2,244	N/A	2,653



Rectangular with TT-bases	Top Size	Base	Model Number	3P	3K	3W
  <div style="margin-top: 20px;">  <p>NE Nesting TT</p> </div>	42 x 60	Static	02TC4260TT34	\$ 1,170	\$ 1,363	\$ 1,470
		Nesting	02TC4260TT34NE	2,202	2,391	2,496
	42 x 72	Static	02TC4272TT34	1,267	1,498	1,606
		Nesting	02TC4272TT34NE	2,297	2,524	2,630
	42 x 84	Static	02TC4284TT34	1,443	1,711	1,821
	42 x 90	Static	02TC4290TT34	1,532	1,836	1,935
	42 x 96 *	Static	02TC4296TT34	1,532	1,837	1,949
	48 x 60	Static	02TC4860TT36	1,196	1,399	1,514
		Nesting	02TC4860TT36NE	2,228	2,427	2,539
	48 x 72	Static	02TC4872TT36	1,350	1,613	1,712
		Nesting	02TC4872TT36NE	2,378	2,637	2,733
	48 x 84	Static	02TC4884TT36	1,443	1,711	1,836
	48 x 90	Static	02TC4890TT36	1,533	1,838	1,950
	48 x 96 *	Static	02TC4896TT36	1,533	1,838	1,965



* \$200 NET surcharge per order for oversized pallet

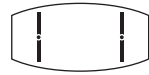

For Fundamental series table options, please reference pages 54-55.

Top Size	Base	Model Number	3P	3K	3W	Rectangular with 3 TT-bases
42 x 120	Static	02TC42120TT34(3)	\$ 2,214	\$ 2,665	\$ 2,727	 
42 x 144	Static	02TC42144TT34(3)	2,399	2,924	2,989	
48 x 120	Static	02TC48120TT36(3)	2,225	2,681	2,754	
48 x 144	Static	02TC48144TT36(3)	2,412	2,943	3,019	

LC CH SH ← ⊗
 N/A +158 quote 3 bases:

Top Size	Base	Model Number	3P	3K	3W	Boat-shaped with T-bases
30 x 42 x 84	Static	02BT3084T26	\$ 1,454	\$ 1,818	\$ 1,812	 
30 x 42 x 90	Static	02BT3090T26	1,583	1,999	1,968	
30 x 42 x 96 *	Static	02BT3096T26	1,583	1,999	1,983	

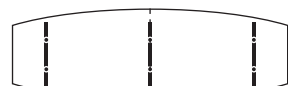
Top Size	Base	Model Number	3P	3K	3W	Boat-shaped with TT-bases
36 x 48 x 84	Static	02BT3684TT34	\$ 1,811	\$ 2,225	\$ 2,189	 
36 x 48 x 90	Static	02BT3690TT34	1,957	2,430	2,365	
36 x 48 x 96 *	Static	02BT3696TT34	1,957	2,430	2,380	

Top Size	Base	Model Number	3P	3K	3W	Boat-shaped with 3 TT-bases
36 x 48 x 120	Static	02BT36120TT36(3)	\$ 2,746	\$ 3,411	\$ 3,276	 
36 x 48 x 144	Static	02BT36144TT36(3)	3,040	3,821	3,659	



LC CH SH ← ⊗
 N/A +158 quote 3 bases:



* \$200 NET surcharge per order for oversized pallet

For Fundamental series table options, please reference pages 54-55.

fundamental

Racetrack with T-bases	Top Size	Base	Model Number	3P	3K	3W
    <p>FD Folding T NE Nesting T</p>	36 x 60	Static	02RT3660T26	\$ 1,131	\$ 1,400	\$ 1,398
		Nesting	02RT3660T26NE	1,909	2,172	2,170
	36 x 72	Static	02RT3672T26	1,131	1,400	1,427
		Folding	02RT3672T26FD	1,457	1,726	1,753
		Nesting	02RT3672T26NE	1,981	2,244	2,271
	36 x 84	Static	02RT3684T26	1,451	1,814	1,799
		Folding	02RT3684T26FD	1,692	2,054	2,041
	36 x 90	Static	02RT3690T26	1,583	1,999	1,960
		Folding	02RT3690T26FD	1,824	2,239	2,201
	36 x 96 *	Static	02RT3696T26	1,583	1,999	1,974
		Folding	02RT3696T26FD	1,824	2,239	2,216

Racetrack with TT-bases	Top Size	Base	Model Number	3P	3K	3W
 	42 x 84	Static	02RT4284TT34	\$ 1,992	\$ 2,356	\$ 2,349
	42 x 90	Static	02RT4290TT34	2,125	2,540	2,510
	42 x 96 *	Static	02RT4296TT34	2,125	2,540	2,525
	48 x 84	Static	02RT4884TT34	2,271	2,744	2,663
	48 x 90	Static	02RT4890TT34	2,271	2,744	2,678
	48 x 96 *	Static	02RT4896TT34	2,271	2,744	2,693

Racetrack with 3 TT-bases	Top Size	Base	Model Number	3P	3K	3W
  <div style="display: flex; align-items: center; margin-top: 10px;"> ⊗ → <div style="display: flex; gap: 10px;"> <div style="border: 1px solid black; border-radius: 50%; padding: 2px 5px;">LC</div> <div style="border: 1px solid black; border-radius: 50%; padding: 2px 5px;">CH</div> <div style="border: 1px solid black; border-radius: 50%; padding: 2px 5px;">SH</div> </div> </div> <p>3 bases: N/A +158 quote</p>	42 x 120	Static	02RT42120TT34(3)	\$ 2,730	\$ 3,388	\$ 3,250
	42 x 144	Static	02RT42144TT34(3)	3,021	3,795	3,629
	48 x 120	Static	02RT48120TT36(3)	2,747	3,412	3,276
	48 x 144	Static	02RT48144TT36(3)	3,040	3,822	3,659

* \$200 NET surcharge per order for oversized pallet

For Fundamental series table options, please reference pages 54-55.

Top Size	Base	Model Number	3P	3K	3W	Elliptical with T-bases
30 x 54	Static	02EL3054T22	\$ 881	\$ 1,050	\$ 1,086	
30 x 60	Static	02EL3060T22	926	1,113	1,147	
36 x 60	Static	02EL3660T26	1,024	1,249	1,267	
36 x 72	Static	02EL3672T26	1,131	1,400	1,409	
36 x 84	Static	02EL3684T26	1,329	1,643	1,640	
36 x 90	Static	02EL3690T26	1,437	1,794	1,770	
36 x 96 *	Static	02EL3696T26	1,437	1,794	1,781	

Top Size	Base	Model Number	3P	3K	3W	Elliptical with TT-bases
42 x 72	Static	02EL4272TT26	\$ 1,411	\$ 1,724	\$ 1,710	
42 x 84	Static	02EL4284TT26	1,616	1,980	1,951	
42 x 90	Static	02EL4290TT26	1,751	2,168	2,111	
42 x 96 *	Static	02EL4296TT26	1,751	2,168	2,123	
48 x 72	Static	02EL4872TT30	1,518	1,875	1,840	
48 x 84	Static	02EL4884TT30	1,895	2,368	2,270	
48 x 90	Static	02EL4890TT30	1,895	2,368	2,281	
48 x 96 *	Static	02EL4896TT30	1,895	2,368	2,293	



Top Size	Base	Model Number	3P	3K	3W	Elliptical with 3 TT-bases
42 x 120	Static	02EL42120TT34(3)	\$ 2,730	\$ 3,388	\$ 3,209	
42 x 144	Static	02EL42144TT34(3)	3,021	3,795	3,575	
48 x 120	Static	02EL48120TT36(3)	2,747	3,412	3,239	
48 x 144	Static	02EL48144TT36(3)	3,040	3,822	3,608	



LC CH SH ← ⊗
 N/A +158 quote 3 bases:



* \$200 NET surcharge per order for oversized pallet

For Fundamental series table options, please reference pages 54-55.



fundamental



Square with X-base	Top Size	Base	Model Number	3P	3K	3W
   <p>Flip Top X</p>	24 x 24	Static	02SQ2424X22	\$ 470	\$ 515	\$ 600
		Flip Top	02SQ2424X22FT	625	670	755
	30 x 30	Static	02SQ3030X26	540	611	706
		Flip Top	02SQ3030X26FT	696	766	861
	36 x 36	Static	02SQ3636X32	642	742	845
		Flip Top	02SQ3636X32FT	797	897	1,000
	42 x 42	Static	02SQ4242X36	741	875	981
		Flip Top	02SQ4242X36FT	972	1,106	1,212
	48 x 48	Static	02SQ4848X38	861	1,036	1,142

Square with 4-column X-base	Top Size	Base	Model Number	3P	3K	3W
   <p>X.4: N/A +272</p>	54 x 54	Static	02SQ5454X36.4	\$ 1,222	\$ 1,442	\$ 1,543
	60 x 60	Static	02SQ6060X42.4	1,480	1,751	1,844

Square with TT-bases	Top Size	Base	Model Number	3P	3K	3W
   <p>nesting TT</p>	48 x 48	Static	02SQ4848TT34	\$ 1,126	\$ 1,301	\$ 1,407
		Nesting	02SQ4848TT34NE	2,159	2,330	2,434

For Fundamental series table options, please reference pages 54-55.

Top Size	Base	Model Number	3P	3K	3W	Round with X-base
24 x 24	Static	02RD24X22	\$ 508	\$ 569	\$ 616	 
	Flip Top	02RD24X22FT	663	724	771	
30 x 30	Static	02RD30X26	600	693	740	
	Flip Top	02RD30X26FT	755	849	895	
36 x 36	Static	02RD36X30	708	837	879	
	Flip Top	02RD36X30FT	864	993	1,035	
42 x 42	Static	02RD42X32	831	1,007	1,038	
	Flip Top	02RD42X32FT	1,063	1,238	1,270	
48 x 48	Static	02RD48X36	875	1,064	1,108	 <p>FT Flip Top X</p>



Top Size	Base	Model Number	3P	3K	3W	Round with 4-column X-base
54 x 54	Static	02RD54X32.4	\$ 1,271	\$ 1,536	\$ 1,547	 
60 x 60	Static	02RD60X36.4	1,358	1,633	1,659	

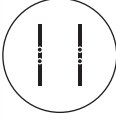

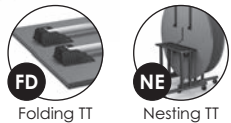
Top Size	Base	Model Number	3P	3K	3W	Round with TT-base
48 x 48	Static	02RD48TT26	\$ 1,098	\$ 1,287	\$ 1,331	 
	Nesting	02RD48TT26NE	2,131	2,316	2,360	
54 x 54	Static	02RD54TT30	1,288	1,552	1,563	
	Nesting	02RD54TT30NE	2,317	2,577	2,588	
60 x 60	Static	02RD60TT34	1,377	1,652	1,678	
	Folding	02RD60TT34FD	2,096	2,371	2,398	
	Nesting	02RD60TT34NE	2,405	2,675	2,700	







For Fundamental series table options, please reference pages 54-55.

D-shaped with T-bases	Top Size	Base	Model Number	3P	3K	3W
	24 x 36	Static	02D2436T20	\$ 680	\$ 769	\$ 837
		Nesting	02D2436T20NE	1,340	1,427	1,495
	24 x 48	Static	02D2448T20	754	874	950
		Nesting	02D2448T20NE	1,413	1,529	1,604
	24 x 60	Static	02D2460T20	829	978	1,061
		Nesting	02D2460T20NE	1,486	1,632	1,713
	24 x 72	Static	02D2472T20	903	1,082	1,172
		Nesting	02D2472T20NE	1,599	1,774	1,863
	24 x 84	Static	02D2484T20	1,062	1,270	1,368
		Nesting	02D2484T20NE	1,856	2,060	2,155
	24 x 90	Static	02D2490T20	1,099	1,322	1,423
		Nesting	02D2490T20NE	1,892	2,111	2,210
	24 x 96 *	Static	02D2496T20	1,137	1,375	1,479
		Nesting	02D2496T20NE	1,928	2,162	2,264
	30 x 48	Static	02D3048T26	832	981	1,046
		Nesting	02D3048T26NE	1,489	1,635	1,699
	30 x 60	Static	02D3060T26	926	1,111	1,179
		Nesting	02D3060T26NE	1,581	1,763	1,829
	30 x 72	Static	02D3072T26	1,019	1,242	1,310
		Nesting	02D3072T26NE	1,712	1,931	1,998
	30 x 84	Static	02D3084T26	1,195	1,457	1,526
		Nesting	02D3084T26NE	1,987	2,242	2,310
	30 x 90	Static	02D3090T26	1,243	1,521	1,592
		Nesting-Light	02D3090T26NE-LT	2,306	N/A	N/A
	30 x 96 *	Static	02D3096T26	1,289	1,586	1,658
		Nesting-Light	02D3096T26NE-LT	2,369	N/A	N/A
	36 x 48	Static	02D3648T26	907	1,085	1,140
		Nesting	02D3648T26NE	1,562	1,737	1,791
	36 x 60	Static	02D3660T26	1,019	1,242	1,292
		Nesting	02D3660T26NE	1,757	1,977	2,026
	36 x 72	Static	02D3672T26	1,130	1,398	1,444
		Nesting	02D3672T26NE	1,979	2,242	2,287
	36 x 84	Static	02D3684T26	1,326	1,638	1,682
		Nesting-Light	02D3684T26NE-LT	2,421	N/A	N/A
	36 x 90	Static	02D3690T26	1,382	1,717	1,757
		Nesting-Light	02D3690T26NE-LT	2,497	N/A	N/A
	36 x 96 *	Static	02D3696T26	1,438	1,795	1,834
		Nesting-Light	02D3696T26NE-LT	2,574	N/A	N/A

* \$200 NET surcharge per order for oversized pallet

For Fundamental series table options, please reference pages 54-55.

Top Size	Base	Model Number	3P	3K	3W	D-shaped with TT-bases
42 x 60	Static	02D4260TT34	\$ 2,711	\$ 3,103	\$ 3,034	 
	Nesting	02D4260TT34NE	1,689	2,089	2,048	
42 x 72	Static	02D4272TT34	2,711	3,103	3,063	
	Nesting	02D4272TT34NE	1,804	2,217	2,196	
42 x 84	Static	02D4284TT34	1,878	2,320	2,293	
42 x 90	Static	02D4290TT34	1,951	2,424	2,388	
42 x 96 *	Static	02D4296TT34	1,731	2,148	2,076	
48 x 60	Static	02D4860TT36	2,751	3,160	3,091	
	Nesting	02D4860TT36NE	1,731	2,148	2,106	
48 x 72	Static	02D4872TT36	2,751	3,160	3,119	
	Nesting	02D4872TT36NE	1,815	2,232	2,219	
48 x 84	Static	02D4884TT36	1,889	2,336	2,316	
48 x 90	Static	02D4890TT36	1,964	2,440	2,412	
48 x 96 *	Static	02D4896TT36	1,870	2,323	2,297	



Top Size	Base	Model Number	3P	3K	3W	D-shaped with 4-column X-base
54 x 54	Static	02D5454X36.4	\$ 1,591	\$ 1,960	\$ 1,937	 
60 x 60	Static	02D6060X42.4	1,733	2,105	2,090	



CH	SH	←	⊗
N/A	+272	X.4:	

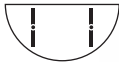

fundamental

* \$200 NET surcharge per order for oversized pallet

For Fundamental series table options, please reference pages 54-55.

Half Round with T-bases	Top Size	Base	Model Number	3P	3K	3W
  	18 x 36	Static	O2HR1836T16	\$ 686	\$ 780	\$ 824
	24 x 48	Static	O2HR2448T16	754	875	936
		Nesting	O2HR2448T16NE	1,413	1,530	1,591
	30 x 60	Static	O2HR3060T20	923	1,110	1,161
		Nesting	O2HR3060T22NE	1,579	1,761	1,811
	36 x 72	Static	O2HR3672T26	1,129	1,396	1,424
		Nesting	O2HR3672T26NE	1,906	2,168	2,195

Trapezoid with T-bases	Top Size	Base	Model Number	3P	3K	3W
  	24 x 48	Static	O2TZ2448T18	\$ 744	\$ 860	\$ 926
	24 x 72	Static	O2TZ2472T18	933	1,125	1,210
		Nesting	O2TZ2472T18NE	1,588	1,776	1,859
	30 x 60	Static	O2TZ3060T22	874	1,041	1,106
		Nesting	O2TZ3060T22NE	1,530	1,694	1,758
	36 x 72	Static	O2TZ3672T26	1,102	1,359	1,395
		Nesting	O2TZ3672T26NE	1,880	2,132	2,167

Squircle with X-base	Top Size	Base	Model Number	3P	3K	3W
 	24 x 24	Static	O2SL24X22	\$ 680	\$ 810	\$ 831
		Flip Top	O2SL24X22FT	836	965	986
	30 x 30	Static	O2SL30X26	746	898	932
		Flip Top	O2SL30X26FT	901	1,054	1,087
	36 x 36	Static	O2SL36X32	835	1,013	1,058
		Flip Top	O2SL36X32FT	992	1,168	1,213
	42 x 42	Static	O2SL42X36	915	1,120	1,173
		Flip Top	O2SL42X36FT	1,146	1,351	1,404
	48 x 48	Static	O2SL48X38	1,017	1,254	1,313

For Fundamental series table options, please reference pages 54-55.

For Fundamental series table options, please reference pages 54-55.

tablex

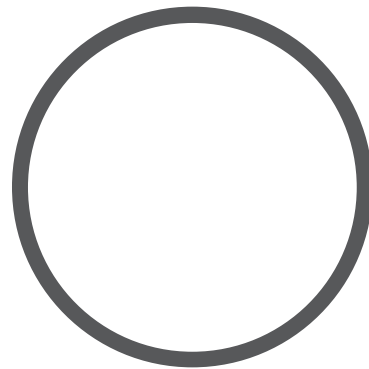

06 stretch
price list
Effective May 16, 2022

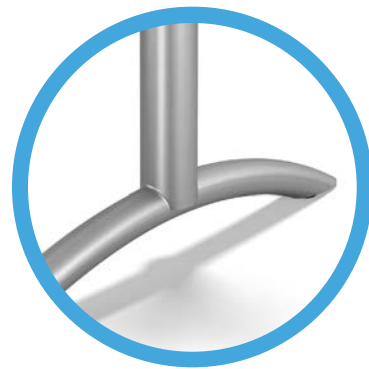



The smoothly curved and sleek look of Stretch makes it a great option for classrooms and training rooms. Its tubular steel construction provides strength and a contemporary design aesthetic.

Stretch Base Styles



Stretch Options



- LC Locking Casters** can be added to any table for \$105 per set of four.
- CH Chrome Finish** available for \$120 on most models.
- SH Special Height** can be added to any table:
+ \$68 per column for heights > 29"
+ \$37 per column for heights < 29"
Special height tables with tops larger than 36x72" must be custom quoted.
- FD Folding Bases** priced accordingly with standard glides.
- WM Wire Management** Built-in wire management is available for \$132 per column. Specify inside or outside of column.
- FR Footring** is not available on the Stretch series.
- NE Nesting Tables** priced accordingly with locking casters.
- WM-LC Wire Management Leg Covers** snap onto any leg and are \$47 each.
- PB Powerbox Mounting Plate** is available on X-bases for \$95.
- FT Flip Tops** available on X-based tables and are priced with standard glides.
- OS Offset T-bases** available for \$37 per table. Offset is not available on 18"d tables or 30"d nesting tables less than 60" wide.

Stretch Height Adjustable Options

AH Spring Clip is available on X-bases for \$132 and on T-bases for \$263 per table. For height option details, see page 19.

Stretch Top Shapes



Rectangle p.72

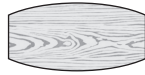

Boat p.75



Racetrack p.76

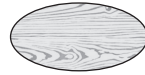

Elliptical p.77



Square p.78



Round p.79



D-shaped p.80



Half Round p.82



Trapezoid p.82



Squircle p.82

Stretch Top Options

QG Quick-Connect Ganging Brackets can be added to any table for \$42 (includes 4 connectors per table).

GN Ganging Plates & Knobs can be added to most table shapes for \$42 (includes 2 plates & 8 knobs per table).

RC 3" Radius Corners can be added to any table for \$58.





LT Lightweight Tops can be added to any square or rectangular table for \$121.

GR Grommets can be added to any table for \$42 each. To see specific locations, see page 217.

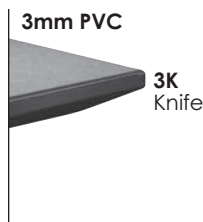
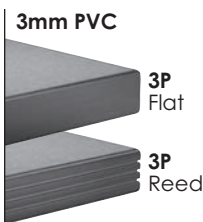
Stretch Edge Options

(corresponds with 3 columns of pricing)







Rectangular with T-bases	Top Size	Base	Model Number	3P	3K	3W
   	20 x 36	Static	06TC2036T18	\$ 680	\$ 748	\$ 835
		Nesting	06TC2036T18NE	1,340	1,406	1,493
	20 x 48	Static	06TC2048T18	734	825	926
		Folding	06TC2048T18FD	1,047	1,137	1,237
		Nesting	06TC2048T18NE	1,394	1,481	1,580
	20 x 60	Static	06TC2060T18	761	859	982
		Folding	06TC2060T18FD	1,085	1,185	1,308
		Nesting	06TC2060T18NE	1,418	1,516	1,636
	20 x 72	Static	06TC2072T18	808	926	1,064
		Folding	06TC2072T18FD	1,132	1,251	1,390
		Nesting	06TC2072T18NE	1,689	1,804	1,940
	20 x 84	Static	06TC2084T18	983	1,139	1,278
		Folding	06TC2084T18FD	1,225	1,379	1,520
		Nesting	06TC2084T18NE	1,778	1,930	2,068
	20 x 90	Static	06TC2090T18	1,038	1,214	1,354
		Folding	06TC2090T18FD	1,279	1,456	1,594
		Nesting	06TC2090T18NE	1,832	2,005	2,141
	20 x 96 *	Static	06TC2096T18	1,038	1,214	1,369
Folding		06TC2096T18FD	1,279	1,456	1,609	
Nesting		06TC2096T18NE	1,832	2,005	2,156	
24 x 36	Static	06TC2436T22	680	748	846	
	Nesting	06TC2436T22NE	1,340	1,406	1,502	
24 x 48	Static	06TC2448T22	734	825	935	
	Folding	06TC2448T22FD	1,047	1,137	1,248	
	Nesting	06TC2448T22NE	1,394	1,481	1,590	
24 x 60	Static	06TC2460T22	761	859	993	
	Folding	06TC2460T22FD	1,085	1,185	1,318	
	Nesting	06TC2460T22NE	1,418	1,516	1,646	
24 x 72	Static	06TC2472T22	808	926	1,074	
	Folding	06TC2472T22FD	1,132	1,251	1,399	
	Nesting	06TC2472T22NE	1,689	1,804	1,950	
24 x 84	Static	06TC2484T22	983	1,139	1,289	
	Folding	06TC2484T22FD	1,225	1,379	1,529	
	Nesting	06TC2484T22NE	1,778	1,930	2,077	
24 x 90	Static	06TC2490T22	1,038	1,214	1,363	
	Folding	06TC2490T22FD	1,279	1,456	1,605	
	Nesting	06TC2490T22NE	1,832	2,005	2,151	
24 x 96 *	Static	06TC2496T22	1,038	1,214	1,378	
	Folding	06TC2496T22FD	1,279	1,456	1,620	
	Nesting	06TC2496T22NE	1,832	2,005	2,166	

* \$200 NET surcharge per order for oversized pallet

For Stretch series table options, please reference pages 70-71.



stretch

Top Size	Base	Model Number	3P	3K	3W	Rectangular with T-bases
30 x 36	Static	06TC3036T26	\$ 724	\$ 808	\$ 909	   
	Nesting	06TC3036T26NE	1,383	1,465	1,564	
30 x 48	Static	06TC3048T26	792	902	1,013	
	Folding	06TC3048T26FD	1,105	1,215	1,325	
	Nesting	06TC3048T26NE	1,449	1,559	1,666	
30 x 60	Static	06TC3060T26	813	933	1,065	
	Folding	06TC3060T26FD	1,139	1,257	1,391	
	Nesting	06TC3060T26NE	1,470	1,587	1,717	
30 x 72	Static	06TC3072T26	866	1,006	1,153	
	Folding	06TC3072T26FD	1,191	1,332	1,478	
	Nesting	06TC3072T26NE	1,746	1,884	2,027	
30 x 84	Static	06TC3084T26	1,079	1,271	1,409	
	Folding	06TC3084T26FD	1,320	1,512	1,650	
	Nesting	06TC3084T26NE	1,873	2,061	2,196	
30 x 90	Static	06TC3090T26	1,147	1,367	1,498	
	Folding	06TC3090T26FD	1,389	1,608	1,739	
	Nesting-Light	01TC3090T26NE-LT	2,154	N/A	2,519	
30 x 96 *	Static	06TC3096T26	1,147	1,367	1,512	
	Folding	06TC3096T26FD	1,389	1,608	1,754	
	Nesting-Light	06TC3096T26NE-LT	2,154	N/A	2,534	
36 x 48	Static	06TC3648T26	846	978	1,086	
	Folding	06TC3648T26FD	1,159	1,290	1,398	
	Nesting	06TC3648T26NE	1,628	1,758	1,864	
36 x 60	Static	06TC3660T26	927	1,090	1,205	
	Folding	06TC3660T26FD	1,252	1,416	1,529	
	Nesting	06TC3660T26NE	1,779	1,941	2,052	
36 x 72	Static	06TC3672T26	977	1,162	1,290	
	Folding	06TC3672T26FD	1,302	1,487	1,615	
	Nesting	06TC3672T26NE	1,855	2,036	2,161	
36 x 84	Static	06TC3684T26	1,172	1,401	1,525	
	Folding	06TC3684T26FD	1,414	1,643	1,767	
	Nesting-Light	06TC3684T26NE-LT	2,189	N/A	2,557	
36 x 90	Static	06TC3690T26	1,252	1,512	1,628	
	Folding	06TC3690T26FD	1,493	1,754	1,869	
	Nesting-Light	06TC3690T26NE-LT	2,298	N/A	2,693	
36 x 96 *	Static	06TC3696T26	1,252	1,512	1,643	
	Folding	06TC3696T26FD	1,493	1,754	1,884	
	Nesting-Light	06TC3696T26NE-LT	2,298	N/A	2,707	



stretch

* \$200 NET surcharge per order for oversized pallet

For Stretch series table options, please reference pages 70-71.

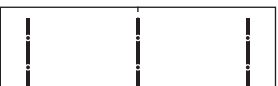

Rectangular with TT-bases	Top Size	Base	Model Number	3P	3K	3W
   Nesting TT	42 x 60	Static	06TC4260TT32	\$ 1,310	\$ 1,503	\$ 1,610
		Nesting	06TC4260TT32NE	2,339	2,528	2,633
	42 x 72	Static	06TC4272TT32	1,406	1,637	1,746
		Nesting	06TC4272TT32NE	2,433	2,660	2,766
	42 x 84	Static	06TC4284TT32	1,583	1,851	1,961
	42 x 90	Static	06TC4290TT32	1,672	1,976	2,074
	42 x 96 *	Static	06TC4296TT32	1,672	1,976	2,089
	48 x 60	Static	06TC4860TT36	1,561	1,763	1,878
		Nesting	06TC4860TT36NE	2,585	2,784	2,895
	48 x 72	Static	06TC4872TT36	1,713	1,978	2,075
		Nesting	06TC4872TT36NE	2,735	2,993	3,090
	48 x 84	Static	06TC4884TT36	1,806	2,075	2,199
	48 x 90	Static	06TC4890TT36	1,898	2,202	2,315
	48 x 96 *	Static	06TC4896TT36	1,898	2,202	2,329



stretch

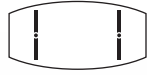

Rectangular with 3 TT-bases	Top Size	Base	Model Number	3P	3K	3W
  	42 x 120	Static	06TC42120TT32(3)	\$ 2,424	\$ 2,874	\$ 2,936
	42 x 144	Static	06TC42144TT32(3)	2,608	3,134	3,199
	48 x 120	Static	06TC48120TT36(3)	2,771	3,227	3,300
	48 x 144	Static	06TC48144TT36(3)	2,958	3,489	3,564

* \$200 NET surcharge per order for oversized pallet

For Stretch series table options, please reference pages 70-71.

Top Size	Base	Model Number	3P	3K	3W	Boat-shaped with T-bases
30 x 42 x 84	Static	06BT3084T26	\$ 1,508	\$ 1,873	\$ 1,866	 
30 x 42 x 90	Static	06BT3090T26	1,637	2,053	2,023	
30 x 42 x 96 *	Static	06BT3096T26	1,637	2,053	2,037	

Top Size	Base	Model Number	3P	3K	3W	Boat-shaped with TT-bases
36 x 48 x 84	Static	06BT3684TT32	\$ 1,949	\$ 2,364	\$ 2,328	 
36 x 48 x 90	Static	06BT3690TT32	2,096	2,570	2,505	
36 x 48 x 96 *	Static	06BT3696TT32	2,096	2,570	2,519	

Top Size	Base	Model Number	3P	3K	3W	Boat-shaped with 3 TT-bases
36 x 48 x 120	Static	06BT36120TT36(3)	\$ 3,292	\$ 3,957	\$ 3,822	 
36 x 48 x 144	Static	06BT36144TT36(3)	3,585	4,367	4,204	



LC CH SH ← ⊗
 N/A +158 quote 3 bases:



stretch



* \$200 NET surcharge per order for oversized pallet

For Stretch series table options, please reference pages 70-71.

Racetrack with T-bases	Top Size	Base	Model Number	3P	3K	3W
   FD Folding T  NE Nesting T	36 x 60	Static	06RT3660T26	\$ 1,186	\$ 1,455	\$ 1,453
		Nesting	06RT3660T26NE	1,963	2,225	2,223
	36 x 72	Static	06RT3672T26	1,186	1,455	1,482
		Folding	06RT3672T26FD	1,511	1,780	1,808
		Nesting	06RT3672T26NE	2,034	2,298	2,324
	36 x 84	Static	06RT3684T26	1,505	1,868	1,855
		Folding	06RT3684T26FD	1,747	2,109	2,095
	36 x 90	Static	06RT3690T26	1,637	2,053	2,014
		Folding	06RT3690T26FD	1,879	2,294	2,256
	36 x 96 *	Static	06RT3696T26	1,637	2,053	2,029
		Folding	06RT3696T26FD	1,879	2,294	2,271

Racetrack with TT-bases	Top Size	Base	Model Number	3P	3K	3W
 	42 x 84	Static	06RT4284TT32	\$ 1,819	\$ 2,181	\$ 2,176
	42 x 90	Static	06RT4290TT32	1,951	2,366	2,336
	42 x 96 *	Static	06RT4296TT32	1,951	2,366	2,350
	48 x 84	Static	06RT4884TT36	2,321	2,795	2,714
	48 x 90	Static	06RT4890TT36	2,321	2,795	2,729
	48 x 96 *	Static	06RT4896TT36	2,321	2,795	2,744



Racetrack with 3 TT-bases	Top Size	Base	Model Number	3P	3K	3W
 	42 x 120	Static	06RT42120TT32(3)	\$ 2,939	\$ 3,598	\$ 3,459
	42 x 144	Static	06RT42144TT32(3)	3,230	4,004	3,838
	48 x 120	Static	06RT48120TT36(3)	3,292	3,957	3,822
	48 x 144	Static	06RT48144TT36(3)	3,586	4,368	4,205



 **LC**
  **CH**
  **SH**
 3 bases: N/A +158 quote

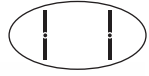

* \$200 NET surcharge per order for oversized pallet

For Stretch series table options, please reference pages 70-71.

stretch

Top Size	Base	Model Number	3P	3K	3W	Elliptical with T-bases
30 x 54	Static	06EL3054T22	\$ 935	\$ 1,105	\$ 1,141	 
30 x 60	Static	06EL3060T22	980	1,168	1,202	
36 x 60	Static	06EL3660T26	1,079	1,304	1,321	
36 x 72	Static	06EL3672T26	1,186	1,455	1,463	
36 x 84	Static	06EL3684T26	1,383	1,697	1,694	
36 x 90	Static	06EL3690T26	1,491	1,848	1,824	
36 x 96 *	Static	06EL3696T26	1,491	1,848	1,836	

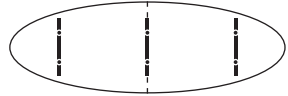
Top Size	Base	Model Number	3P	3K	3W	Elliptical with TT-bases
42 x 72	Static	06EL4272TT26	\$ 1,612	\$ 1,926	\$ 1,911	 
42 x 84	Static	06EL4284TT26	1,819	2,181	2,154	
42 x 90	Static	06EL4290TT26	1,953	2,369	2,314	
42 x 96 *	Static	06EL4296TT26	1,953	2,369	2,325	
48 x 72	Static	06EL4872TT32	1,720	2,077	2,042	
48 x 84	Static	06EL4884TT32	2,097	2,571	2,471	
48 x 90	Static	06EL4890TT32	2,097	2,571	2,483	
48 x 96 *	Static	06EL4896TT32	2,097	2,571	2,494	



Top Size	Base	Model Number	3P	3K	3W	Elliptical with 3 TT-bases
42 x 120	Static	06EL42120TT26(3)	\$ 2,939	\$ 3,598	\$ 3,418	 
42 x 144	Static	06EL42144TT26(3)	3,230	4,004	3,785	
48 x 120	Static	06EL48120TT36(3)	3,292	3,957	3,785	
48 x 144	Static	06EL48144TT36(3)	3,586	4,368	4,154	

LC CH SH ← ⊗
 N/A +158 quote 3 bases:



* \$200 NET surcharge per order for oversized pallet

For Stretch series table options, please reference pages 70-71.



stretch

Square with X-base	Top Size	Base	Model Number	3P	3K	3W
 	24 x 24	Static	06SQ2424X22	\$ 691	\$ 737	\$ 822
		Flip Top	06SQ2424X22FT	847	892	977
	30 x 30	Static	06SQ3030X26	754	825	920
		Flip Top	06SQ3030X26FT	910	980	1,076
	36 x 36	Static	06SQ3636X32	879	979	1,082
		Flip Top	06SQ3636X32FT	1,035	1,134	1,237

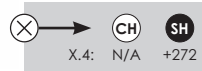

Square with 4-column X-base	Top Size	Base	Model Number	3P	3K	3W
 	42 x 42	Static	06SQ4242X36.4	\$ 1,624	\$ 1,758	\$ 1,864
	48 x 48	Static	06SQ4848X36.4	1,725	1,899	2,005
	54 x 54	Static	06SQ5454X36.4	1,838	2,058	2,159







Square with TT-bases	Top Size	Base	Model Number	3P	3K	3W
 	48 x 48	Static	06SQ4848TT32	\$ 1,266	\$ 1,441	\$ 1,546
		Nesting	06SQ4848TT32NE	2,296	2,467	2,571







For Stretch series table options, please reference pages 70-71.

stretch

Top Size	Base	Model Number	3P	3K	3W	Round with X-base
24 x 24	Static	06RD24X22	\$ 729	\$ 790	\$ 837	  
	Flip Top	06RD24X22FT	885	945	993	
30 x 30	Static	06RD30X26	814	908	954	
	Flip Top	06RD30X26FT	970	1,063	1,109	
36 x 36	Static	06RD36X32	952	1,081	1,124	
	Flip Top	06RD36X32FT	1,107	1,236	1,279	
42 x 42	Static	06RD42X32	1,068	1,244	1,275	
	Flip Top	06RD42X32FT	1,299	1,476	1,506	



Top Size	Base	Model Number	3P	3K	3W	Round with 4-column X-base
48 x 48	Static	06RD48X36.4	\$ 1,758	\$ 1,947	\$ 1,991	 
54 x 54	Static	06RD54X36.4	1,948	2,213	2,223	
60 x 60	Static	06RD60X36.4	1,974	2,250	2,276	

 N/A
  +272
  X.4:

Top Size	Base	Model Number	3P	3K	3W	Round with TT-base
48 x 48	Static	06RD48TT26	\$ 1,300	\$ 1,488	\$ 1,533	   
	Nesting	06RD48TT26NE	2,329	2,514	2,558	
54 x 54	Static	06RD54TT32	1,489	1,755	1,766	
	Nesting	06RD54TT32NE	2,515	2,775	2,786	
60 x 60	Static	06RD60TT32	1,517	1,792	1,818	
	Folding	06RD60TT32FD	2,236	2,511	2,537	
	Nesting	06RD60TT32NE	2,541	2,811	2,837	



For Stretch series table options, please reference pages 70-71.

stretch

D-shaped with T-bases	Top Size	Base	Model Number	3P	3K	3W
	24 x 36	Static	06D2436T22	\$ 734	\$ 824	\$ 892
		Nesting	06D2436T22NE	1,394	1,481	1,548
	24 x 48	Static	06D2448T22	809	928	1,004
		Nesting	06D2448T22NE	1,466	1,583	1,657
	24 x 60	Static	06D2460T22	884	1,033	1,116
		Nesting	06D2460T22NE	1,540	1,686	1,767
	24 x 72	Static	06D2472T22	958	1,137	1,227
		Nesting	06D2472T22NE	1,652	1,827	1,917
 Nesting T	24 x 84	Static	06D2484T22	1,117	1,325	1,422
		Nesting	06D2484T22NE	1,909	2,113	2,209
	24 x 90	Static	06D2490T22	1,153	1,377	1,478
		Nesting	06D2490T22NE	1,945	2,165	2,263
	24 x 96 *	Static	06D2496T22	1,191	1,430	1,533
		Nesting	06D2496T22NE	1,982	2,216	2,318
	30 x 48	Static	06D3048T26	887	1,036	1,101
		Nesting	06D3048T26NE	1,543	1,689	1,753
	30 x 60	Static	06D3060T26	980	1,166	1,233
		Nesting	06D3060T26NE	1,634	1,817	1,882
	30 x 72	Static	06D3072T26	1,074	1,296	1,364
		Nesting	06D3072T26NE	1,766	1,985	2,052
	30 x 84	Static	06D3084T26	1,250	1,511	1,581
		Nesting	06D3084T26NE	2,041	2,296	2,365
	30 x 90	Static	06D3090T26	1,297	1,575	1,647
		Nesting-Light	06D3090T26NE-LT	2,360	N/A	N/A
	30 x 96 *	Static	06D3096T26	1,343	1,641	1,713
		Nesting-Light	06D3096T26NE-LT	2,424	N/A	N/A
	36 x 48	Static	06D3648T26	961	1,140	1,194
		Nesting	06D3648T26NE	1,615	1,791	1,844
	36 x 60	Static	06D3660T26	1,074	1,296	1,347
		Nesting	06D3660T26NE	1,811	2,030	2,079
	36 x 72	Static	06D3672T26	1,185	1,453	1,499
		Nesting	06D3672T26NE	2,032	2,296	2,341
	36 x 84	Static	06D3684T26	1,380	1,693	1,736
		Nesting-Light	06D3684T26NE-LT	2,474	N/A	N/A
	36 x 90	Static	06D3690T26	1,437	1,772	1,812
		Nesting-Light	06D3690T26NE-LT	2,551	N/A	N/A
	36 x 96 *	Static	06D3696T26	1,493	1,850	1,888
		Nesting-Light	06D3696T26NE-LT	2,628	N/A	N/A

* \$200 NET surcharge per order for oversized pallet

For Stretch series table options, please reference pages 70-71.

Top Size	Base	Model Number	3P	3K	3W	D-shaped with TT-bases
42 x 60	Static	06D4260TT32	\$ 1,829	\$ 2,229	\$ 2,158	  
	Nesting	06D4260TT32NE	2,847	3,240	3,170	
42 x 72	Static	06D4272TT32	1,829	2,229	2,188	
	Nesting	06D4272TT32NE	2,847	3,240	3,200	
42 x 84	Static	06D4284TT32	1,944	2,357	2,336	
42 x 90	Static	06D4290TT32	2,018	2,460	2,431	
42 x 96 *	Static	06D4296TT32	2,091	2,562	2,528	
48 x 60	Static	06D4860TT36	2,094	2,511	2,440	
	Nesting	06D4860TT36NE	3,108	3,517	3,447	
48 x 72	Static	06D4872TT36	2,094	2,511	2,469	
	Nesting	06D4872TT36NE	3,108	3,517	3,476	
48 x 84	Static	06D4884TT36	2,178	2,595	2,583	
48 x 90	Static	06D4890TT36	2,253	2,700	2,680	
48 x 96 *	Static	06D4896TT36	2,327	2,804	2,777	

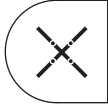
Top Size	Base	Model Number	3P	3K	3W	D-shaped with 4-column X-base								
54 x 54	Static	06D5454X36.4	\$ 2,208	\$ 2,576	\$ 2,552	  <div style="margin-top: 10px;"> <table border="1"> <tr> <td>CH</td> <td>SH</td> <td>←</td> <td>⊗</td> </tr> <tr> <td>N/A</td> <td>+272</td> <td>X.4:</td> <td></td> </tr> </table> </div>	CH	SH	←	⊗	N/A	+272	X.4:	
CH	SH	←	⊗											
N/A	+272	X.4:												

stretch

* \$200 NET surcharge per order for oversized pallet

For Stretch series table options, please reference pages 70-71.

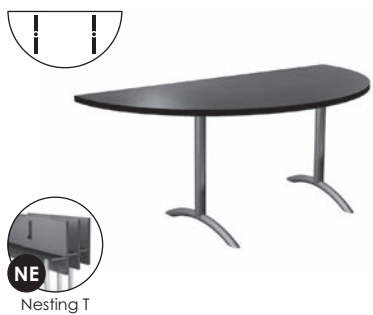
Half Round with T-bases	Top Size	Base	Model Number	3P	3K	3W
 <p>NE Nesting T</p>	24 x 48	Static	06HR2448T18	\$ 812	\$ 933	\$ 995
		Nesting	06HR2448T18NE	1,469	1,588	1,649
	30 x 60	Static	06HR3060T22	978	1,165	1,215
		Nesting	06HR3060T22NE	1,632	1,815	1,864
	36 x 72	Static	06HR3672T26	1,184	1,451	1,479
		Nesting	06HR3672T26NE	1,960	2,221	2,249

Trapezoid with T-bases	Top Size	Base	Model Number	3P	3K	3W
	24 x 48	Static	06TZ2448T18	\$ 803	\$ 919	\$ 984
		24 x 72	Static	06TZ2472T18	992	1,184
	Nesting		06TZ2472T18NE	1,645	1,834	1,917
	30 x 60	Static	06TZ3060T22	929	1,096	1,161
		Nesting	06TZ3060T22NE	1,584	1,748	1,812
	36 x 72	Static	06TZ3672T26	1,157	1,414	1,449
Nesting		06TZ3672T26NE	1,898	2,150	2,184	

Squircle with X-base	Top Size	Base	Model Number	3P	3K	3W
	24 x 24	Static	06SL24X22	\$ 901	\$ 1,032	\$ 1,053
		Flip Top	06SL24X22FT	1,057	1,187	1,208
	30 x 30	Static	06SL30X26	960	1,112	1,146
		Flip Top	06SL30X26FT	1,116	1,268	1,301
	36 x 36	Static	06SL36X32	1,073	1,250	1,294
		Flip Top	06SL36X32FT	1,228	1,405	1,451
42 x 42	Static	06SL42X32	1,141	1,346	1,399	
	Flip Top	06SL42X32FT	1,372	1,577	1,631	

For Stretch series table options, please reference pages 70-71.

For Stretch series table options, please reference pages 70-71.

tablex

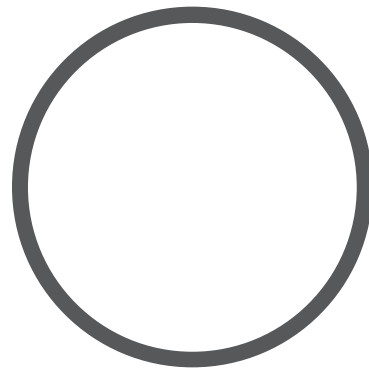

08 elite
price list
Effective May 16, 2022





Elite exudes a contemporary style and provides you with our most flexible offering. Its welded base construction delivers lasting functionality without sacrificing beauty.

Elite Base Styles

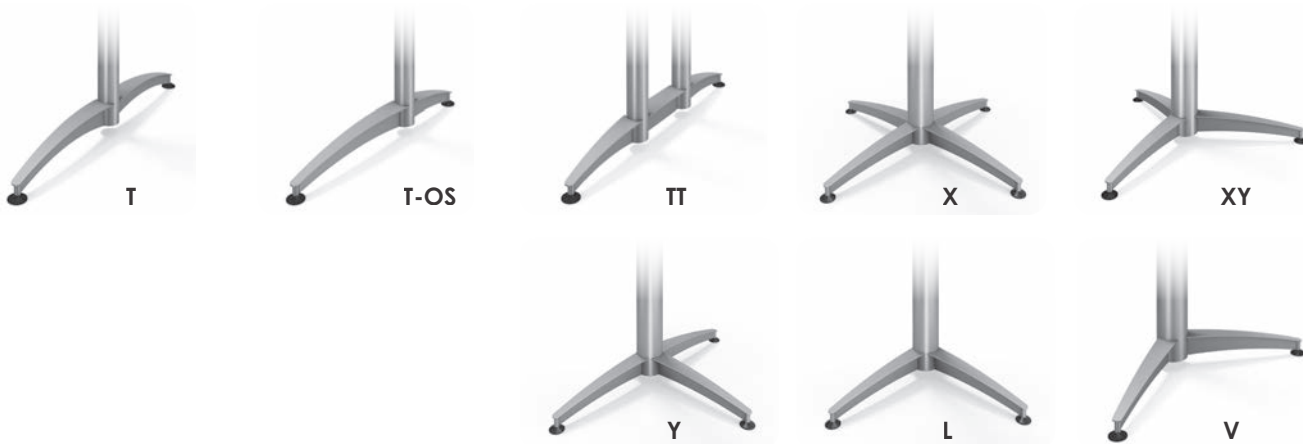

Elite Options

Standard Plastic Glides



Locking Casters



LC **Locking Casters**
can be added to any table for \$105 per set of four.

FD **Folding Bases**
priced accordingly with standard glides.

NE **Nesting Tables**
priced accordingly with locking casters.

FT **Flip Tops**
available on X-based tables and are priced with standard glides.

CH **Chrome Finish**
is not available on Elite tables.

WM **Wire Management**
Built-in wire management is available for \$132 per column. Specify inside or outside of column.

WM LC **2" Wire Management Leg Covers**
snap onto any leg and are \$47 each.

WM LC **3" Wire Management Leg Covers**
snap onto any leg and are \$75 each. 3" required for X, XY, Y, L base styles.

PB **Powerbox Mounting Plate**
is available on X-bases for \$95.

FR **Footring**
is not available on the Elite series.

OS **Offset T-bases**
available for \$37 per table. Offset is not available on 18"d tables or 30"d nesting tables less than 60" wide.

SH **Special Height**
can be added to any table:
+ \$68 per column for heights > 29"
+ \$37 per column for heights < 29"
Special height tables with tops larger than 36x72" must be custom quoted.

Elite Height Adjustable Options

AH Spring Clip is available on X-bases for \$132 and on T-bases for \$263 per table. For height option details, see page 19.

Elite Top Shapes



Rectangle
p.88

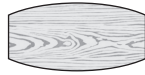

Boat
p.93



Racetrack
p.94

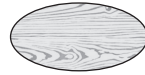

Elliptical
p.95



Square
p.96



Round
p.97



D-shaped
p.98



Half Round
p.100



Trapezoid
p.100



Squirele
p.100

Elite Top Options

QG Quick-Connect Ganging Brackets can be added to any table for \$42 (includes 4 connectors per table).

GN Ganging Plates & Knobs can be added to most table shapes for \$42 (includes 2 plates & 8 knobs per table).

RC 3" Radius Corners can be added to any table for \$58.

LT Lightweight Tops can be added to any square or rectangular table for \$121.

GR Grommets can be added to any table for \$42 each. To see specific locations, see page 217.

Elite Edge Options

(corresponds with 3 columns of pricing)

3mm PVC

3P Flat





3P Reed

3mm PVC

3K Knife





3mm Wood

3W Flat

Rectangular with T-bases	Top Size	Base	Model Number	3P	3K	3W
   	20 x 36	Static	08TC2036T18	\$ 825	\$ 893	\$ 980
		Nesting	08TC2036T18NE	1,482	1,548	1,634
	20 x 48	Static	08TC2048T18	879	970	1,070
		Folding	08TC2048T18FD	1,192	1,281	1,382
		Nesting	08TC2048T18NE	1,536	1,624	1,722
	20 x 60	Static	08TC2060T18	906	1,004	1,127
		Folding	08TC2060T18FD	1,230	1,330	1,453
		Nesting	08TC2060T18NE	1,561	1,658	1,778
	20 x 72	Static	08TC2072T18	953	1,070	1,209
		Folding	08TC2072T18FD	1,277	1,396	1,535
		Nesting	08TC2072T18NE	1,831	1,947	2,083
	20 x 84	Static	08TC2084T18	1,128	1,284	1,423
		Folding	08TC2084T18FD	1,370	1,524	1,665
		Nesting	08TC2084T18NE	1,920	2,072	2,210
	20 x 90	Static	08TC2090T18	1,183	1,359	1,499
		Folding	08TC2090T18FD	1,424	1,601	1,739
		Nesting	08TC2090T18NE	1,973	2,148	2,283
	20 x 96 *	Static	08TC2096T18	1,183	1,359	1,514
Folding		08TC2096T18FD	1,424	1,601	1,754	
Nesting		08TC2096T18NE	1,973	2,148	2,298	
24 x 36	Static	08TC2436T22	825	893	990	
	Nesting	08TC2436T22NE	1,482	1,548	1,644	
24 x 48	Static	08TC2448T22	879	970	1,080	
	Folding	08TC2448T22FD	1,192	1,281	1,393	
	Nesting	08TC2448T22NE	1,536	1,624	1,732	
24 x 60	Static	08TC2460T22	906	1,004	1,138	
	Folding	08TC2460T22FD	1,230	1,330	1,463	
	Nesting	08TC2460T22NE	1,561	1,658	1,789	
24 x 72	Static	08TC2472T22	953	1,070	1,218	
	Folding	08TC2472T22FD	1,277	1,396	1,544	
	Nesting	08TC2472T22NE	1,831	1,947	2,092	
24 x 84	Static	08TC2484T22	1,128	1,284	1,434	
	Folding	08TC2484T22FD	1,370	1,524	1,674	
	Nesting	08TC2484T22NE	1,920	2,072	2,220	
24 x 90	Static	08TC2490T22	1,183	1,359	1,508	
	Folding	08TC2490T22FD	1,424	1,601	1,750	
	Nesting	08TC2490T22NE	1,973	2,148	2,294	
24 x 96 *	Static	08TC2496T22	1,183	1,359	1,523	
	Folding	08TC2496T22FD	1,424	1,601	1,764	
	Nesting	08TC2496T22NE	1,973	2,148	2,307	



* \$200 NET surcharge per order for oversized pallet

For Elite series table options, please reference pages 86-87.

Top Size	Base	Model Number	3P	3K	3W	Rectangular with T-bases
30 x 36	Static	08TC3036T26	\$ 877	\$ 961	\$ 1,061	   
	Nesting	08TC3036T26NE	1,533	1,615	1,714	
30 x 48	Static	08TC3048T26	945	1,056	1,165	
	Folding	08TC3048T26FD	1,257	1,369	1,478	
	Nesting	08TC3048T26NE	1,600	1,709	1,816	
30 x 60	Static	08TC3060T26	966	1,085	1,218	
	Folding	08TC3060T26FD	1,292	1,411	1,544	
	Nesting	08TC3060T26NE	1,621	1,737	1,867	
30 x 72	Static	08TC3072T26	1,019	1,160	1,306	
	Folding	08TC3072T26FD	1,344	1,485	1,631	
	Nesting	08TC3072T26NE	1,896	2,034	2,177	
30 x 84	Static	08TC3084T26	1,232	1,424	1,562	
	Folding	08TC3084T26FD	1,474	1,666	1,803	
	Nesting	08TC3084T26NE	2,023	2,211	2,346	
30 x 90	Static	08TC3090T26	1,300	1,520	1,651	
	Folding	08TC3090T26FD	1,542	1,760	1,893	
	Nesting-Light	08TC3090T26NE-LT	2,304	N/A	2,670	
30 x 96 *	Static	08TC3096T26	1,300	1,520	1,666	
	Folding	08TC3096T26FD	1,542	1,760	1,907	
	Nesting-Light	08TC3096T26NE-LT	2,304	N/A	2,684	
36 x 48	Static	08TC3648T26	999	1,131	1,239	
	Folding	08TC3648T26FD	1,311	1,443	1,551	
	Nesting	08TC3648T26NE	1,778	1,908	2,014	
36 x 60	Static	08TC3660T26	1,080	1,244	1,357	
	Folding	08TC3660T26FD	1,404	1,569	1,683	
	Nesting	08TC3660T26NE	1,929	2,091	2,202	
36 x 72	Static	08TC3672T26	1,130	1,315	1,443	
	Folding	08TC3672T26FD	1,456	1,641	1,769	
	Nesting	08TC3672T26NE	2,005	2,187	2,312	
36 x 84	Static	08TC3684T26	1,326	1,554	1,678	
	Folding	08TC3684T26FD	1,566	1,796	1,920	
	Nesting	08TC3684T26NE	2,339	N/A	2,707	
36 x 90	Static	08TC3690T26	1,405	1,666	1,781	
	Folding	08TC3690T26FD	1,646	1,907	2,023	
	Nesting-Light	08TC3690T26NE-LT	2,448	N/A	2,843	
36 x 96 *	Static	08TC3696T26	1,405	1,666	1,796	
	Folding	08TC3696T26FD	1,646	1,907	2,037	
	Nesting-Light	08TC3696T26NE-LT	2,448	N/A	2,858	



* \$200 NET surcharge per order for oversized pallet



For Elite series table options, please reference pages 86-87.



Rectangular with V-bases	Top Size	Base	Model Number	3P	3K	3W
 	24 x 48	Static	08TC2448V22	\$ 1,058	\$ 1,147	\$ 1,257
		Nesting	08TC2448V22NE	1,710	1,798	1,906
	24 x 60	Static	08TC2460V22	1,083	1,183	1,315
		Nesting	08TC2460V22NE	1,735	1,833	1,963
	24 x 72	Static	08TC2472V22	1,130	1,249	1,397
		Nesting	08TC2472V22NE	2,005	2,121	2,266
	24 x 84	Static	08TC2484V22	1,306	1,461	1,611
		Nesting	08TC2484V22NE	2,094	2,246	2,394
	24 x 90	Static	08TC2490V22	1,360	1,538	1,686
		Nesting	08TC2490V22NE	2,148	2,322	2,468
	24 x 96 *	Static	08TC2496V22	1,360	1,538	1,700
		Nesting	08TC2496V22NE	2,148	2,322	2,482
	30 x 48	Static	08TC3048V26	1,152	1,263	1,372
		Nesting	08TC3036V26NE	1,802	1,911	2,019
	30 x 60	Static	08TC3060V26	1,173	1,292	1,425
		Nesting	08TC3060V26NE	1,823	1,941	2,070
	30 x 72	Static	08TC3072V26	1,226	1,367	1,512
		Nesting	08TC3072V26NE	2,099	2,237	2,381
	30 x 84	Static	08TC3084V26	1,439	1,631	1,769
		Nesting	08TC3084V26NE	2,225	2,414	2,549
	30 x 90	Static	08TC3090V26	1,507	1,727	1,858
		Nesting-Light	08TC3090V26NE-LT	2,507	N/A	2,873
	30 x 96 *	Static	08TC3096V26	1,507	1,727	1,873
		Nesting-Light	08TC3096V26NE-LT	2,507	N/A	2,887
	36 x 48	Static	08TC3648V32	1,275	1,407	1,516
		Nesting	08TC3648V32NE	2,050	2,179	2,285
	36 x 60	Static	08TC3660V32	1,356	1,521	1,634
		Nesting	08TC3660V32NE	2,200	2,362	2,473
	36 x 72	Static	08TC3672V32	1,407	1,592	1,719
		Nesting	08TC3672V32NE	2,277	2,457	2,583
	36 x 84	Static	08TC3684V32	1,602	1,831	1,956
		Nesting-Light	08TC3684V32NE-LT	2,610	N/A	2,979
	36 x 90	Static	08TC3690V32	1,682	1,943	2,057
		Nesting-Light	08TC3690V32NE-LT	2,719	N/A	3,114
	36 x 96 *	Static	08TC3696V32	1,682	1,943	2,072
		Nesting-Light	08TC3696V32NE-LT	2,719	N/A	3,128

* \$200 NET surcharge per order for oversized pallet

For Elite series table options, please reference pages 86-87.

Top Size	Base	Model Number	3P	3K	3W	Rectangle with TT-bases
42 x 60	Static	08TC4260TT32	\$ 1,573	\$ 1,767	\$ 1,874	  
	Nesting	08TC4260TT32NE	2,597	2,786	2,892	
42 x 72	Static	08TC4272TT32	1,670	1,901	2,009	
	Nesting	08TC4272TT32NE	2,692	2,918	3,024	
42 x 84	Static	08TC4284TT32	1,846	2,114	2,224	
42 x 90	Static	08TC4290TT32	1,936	2,239	2,338	
42 x 96 *	Static	08TC4296TT32	1,936	2,239	2,352	
48 x 60	Static	08TC4860TT32	1,600	1,802	1,917	
	Nesting	08TC4860TT32NE	2,623	2,822	2,934	
48 x 72	Static	08TC4872TT32	1,753	2,016	2,115	
	Nesting	08TC4872TT32NE	2,772	3,032	3,128	
48 x 84	Static	08TC4884TT32	1,846	2,114	2,239	
48 x 90	Static	08TC4890TT32	1,937	2,241	2,354	
48 x 96 *	Static	08TC4896TT32	1,937	2,241	2,368	

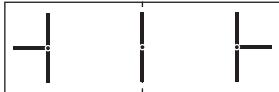
Top Size	Base	Model Number	3P	3K	3W	Rectangle with Y-bases
42 x 60	Static	08TC4260Y36	\$ 1,711	\$ 1,904	\$ 2,011	 
42 x 72	Static	08TC4272Y36	1,808	2,039	2,147	
42 x 84	Static	08TC4284Y36	1,900	2,168	2,278	
42 x 90	Static	08TC4290Y36	1,989	2,294	2,391	
42 x 96 *	Static	08TC4296Y36	1,989	2,294	2,406	
48 x 60	Static	08TC4860Y36	1,737	1,941	2,054	
48 x 72	Static	08TC4872Y36	1,890	2,154	2,253	
48 x 84	Static	08TC4884Y36	1,900	2,168	2,293	
48 x 90	Static	08TC4890Y36	1,990	2,295	2,407	
48 x 96 *	Static	08TC4896Y36	1,990	2,295	2,422	

Top Size	Base	Model Number	3P	3K	3W	Rectangle with Y & T-bases
42 x 120	Static	08TC42120Y36T36	\$ 2,768	\$ 3,220	\$ 3,281	 
42 x 144	Static	08TC42144Y36T36	2,953	3,478	3,543	
48 x 120	Static	08TC48120Y36T36	2,780	3,236	3,308	
48 x 144	Static	08TC48144Y36T36	2,967	3,497	3,573	

LC SH ← ⊗
N/A quote 3 bases:

* \$200 NET surcharge per order for oversized pallet

For Elite series table options, please reference pages 86-87.

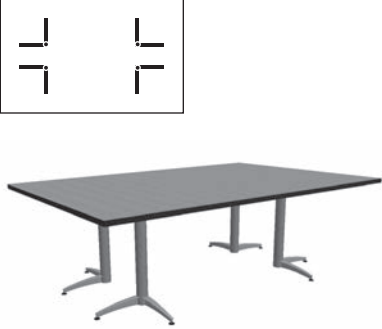
Rectangular with L-bases	Top Size	Base	Model Number	3P	3K	3W
	54 x 60	Static	08TC5460L26	\$ 2,390	\$ 2,638	\$ 2,734
	54 x 72	Static	08TC5472L26	2,514	2,811	2,900
	54 x 84	Static	08TC5484L26	2,638	2,985	3,065
	54 x 90	Static	08TC5490L26	2,700	3,072	3,148
	54 x 96 *	Static	08TC5496L26	2,762	3,158	3,231
	60 x 72	Static	08TC6072L26	2,597	2,927	3,006
	60 x 84	Static	08TC6084L26	2,735	3,120	3,186
	60 x 90	Static	08TC6090L26	2,803	3,216	3,276
	60 x 96 *	Static	08TC6096L26	2,872	3,312	3,367

⊗ → LC SH
4 bases: +190 quote

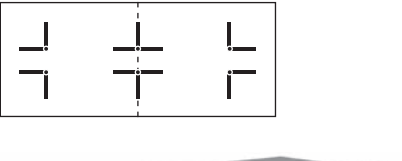
Rectangular with L & Y-bases	Top Size	Base	Model Number	3P	3K	3W
	54 x 120	Static	08TC54120L26Y26	\$ 4,163	\$ 4,724	\$ 4,733
	54 x 144	Static	08TC54144L26Y26	4,410	5,071	5,064
	60 x 120	Static	08TC60120L26Y26	4,279	4,887	4,876
	60 x 144	Static	08TC60144L26Y26	4,575	5,302	5,261

⊗ → LC SH
3 bases: N/A N/A

* \$200 NET surcharge per order for oversized pallet

For Elite series table options, please reference pages 86-87.

Top Size	Base	Model Number	3P	3K	3W	Boat-shaped with T-bases
30 x 42 x 84	Static	08BT3084T26	\$ 1,662	\$ 2,026	\$ 2,020	
30 x 42 x 90	Static	08BT3090T26	1,791	2,207	2,176	
30 x 42 x 96 *	Static	08BT3096T26	1,791	2,207	2,191	

Top Size	Base	Model Number	3P	3K	3W	Boat-shaped with Y-bases
36 x 48 x 84	Static	08BT3684Y26	\$ 2,173	\$ 2,588	\$ 2,551	
36 x 48 x 90	Static	08BT3690Y26	2,320	2,793	2,727	
36 x 48 x 96 *	Static	08BT3696Y26	2,320	2,793	2,742	

Top Size	Base	Model Number	3P	3K	3W	Boat-shaped with Y & T-bases
36 x 48 x 120	Static	08BT36120Y26T32	\$ 3,170	\$ 3,834	\$ 3,700	
36 x 48 x 144	Static	08BT36144Y26T32	3,463	4,246	4,082	





LC N/A SH quote 3 bases: X



Top Size	Base	Model Number	3P	3K	3W	Boat-shaped with L & Y-bases
42 x 54 x 120	Static	08BT42120L26Y26	\$ 4,603	\$ 5,339	\$ 5,159	
42 x 54 x 144	Static	08BT42144L26Y26	4,801	5,617	5,436	
48 x 60 x 120	Static	08BT48120L26Y26	4,635	5,386	5,204	
48 x 60 x 144	Static	08BT48144L26Y26	4,839	5,672	5,487	



LC N/A SH N/A 3 bases: X



* \$200 NET surcharge per order for oversized pallet

For Elite series table options, please reference pages 86-87.

Race rack with T-bases	Top Size	Base	Model Number	3P	3K	3W
   	36 x 60	Static	08RT3660T26	\$1,339	\$1,608	\$1,606
		Nesting	08RT3660T26NE	2,113	2,377	2,373
	36 x 72	Static	08RT3672T26	1,339	1,608	1,635
		Folding	08RT3672T26FD	1,665	1,934	1,961
		Nesting	08RT3672T26NE	2,184	2,448	2,474
	36 x 84	Static	08RT3684T26	1,658	2,022	2,007
		Folding	08RT3684T26FD	1,900	2,262	2,249
	36 x 90	Static	08RT3690T26	1,791	2,207	2,168
		Folding	08RT3690T26FD	2,032	2,447	2,408
	36 x 96 *	Static	08RT3696T26	1,791	2,207	2,182
		Folding	08RT3696T26FD	2,032	2,447	2,424

Race rack with Y-bases	Top Size	Base	Model Number	3P	3K	3W
 	42 x 84	Static	08RT4284Y32	\$2,104	\$2,466	\$2,461
	42 x 90	Static	08RT4290Y32	2,236	2,651	2,620
	42 x 96 *	Static	08RT4296Y32	2,236	2,651	2,636
	48 x 84	Static	08RT4884Y36	2,413	2,887	2,807
	48 x 90	Static	08RT4890Y36	2,413	2,887	2,822
	48 x 96 *	Static	08RT4896Y36	2,413	2,887	2,837

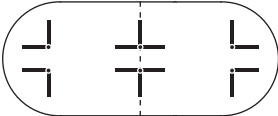
Race rack with Y & T-bases	Top Size	Base	Model Number	3P	3K	3W
  <div style="display: flex; align-items: center; margin-top: 10px;"> X → <div style="display: flex; gap: 5px;"> LC SH </div> </div> <p style="font-size: small; margin-top: 5px;">3 bases: N/A quote</p>	42 x 120	Static	08RT42120Y32T32	\$2,842	\$3,499	\$3,362
	42 x 144	Static	08RT42144Y32T32	3,132	3,906	3,741
	48 x 120	Static	08RT48120Y36T36	2,891	3,555	3,420
	48 x 144	Static	08RT48144Y36T36	3,184	3,966	3,803

Race rack with L & Y-bases	Top Size	Base	Model Number	3P	3K	3W
  <div style="display: flex; align-items: center; margin-top: 10px;"> X → <div style="display: flex; gap: 5px;"> LC SH </div> </div> <p style="font-size: small; margin-top: 5px;">3 bases: N/A N/A</p>	54 x 120	Static	08RT54120L26Y26	\$3,796	\$4,607	\$4,371
	54 x 144	Static	08RT54144L26Y26	4,094	5,024	4,758
	60 x 120	Static	08RT60120L26Y26	3,796	4,607	4,379
	60 x 144	Static	08RT60144L26Y26	4,094	5,024	4,766

* \$200 NET surcharge per order for oversized pallet

For Elite series table options, please reference pages 86-87.

Top Size	Base	Model Number	3P	3K	3W	Elliptical with T-bases
30 x 54	Static	08EL3054T22	\$ 1,080	\$ 1,250	\$ 1,286	
30 x 60	Static	08EL3060T22	1,125	1,313	1,347	
36 x 60	Static	08EL3660T26	1,232	1,457	1,474	
36 x 72	Static	08EL3672T26	1,339	1,608	1,616	
36 x 84	Static	08EL3684T26	1,537	1,851	1,847	
36 x 90	Static	08EL3690T26	1,645	2,001	1,978	
36 x 96 *	Static	08EL3696T26	1,645	2,001	1,989	

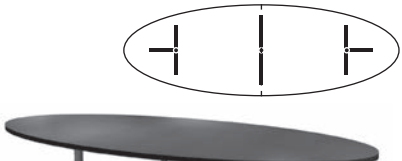

Top Size	Base	Model Number	3P	3K	3W	Elliptical with Y-bases
42 x 72	Static	08EL4272Y26	\$ 1,836	\$ 2,149	\$ 2,135	
42 x 84	Static	08EL4284Y26	2,042	2,405	2,377	
42 x 90	Static	08EL4290Y26	2,176	2,593	2,536	
42 x 96 *	Static	08EL4296Y26	2,176	2,593	2,548	
48 x 72	Static	08EL4872Y32	2,005	2,362	2,327	
48 x 84	Static	08EL4884Y32	2,382	2,855	2,756	
48 x 90	Static	08EL4890Y32	2,382	2,855	2,767	
48 x 96 *	Static	08EL4896Y32	2,382	2,855	2,779	



Top Size	Base	Model Number	3P	3K	3W	Elliptical with Y & T-bases
42 x 120	Static	08EL42120Y26T32	\$ 3,155	\$ 3,812	\$ 3,632	
42 x 144	Static	08EL42144Y26T32	3,444	4,218	3,999	
48 x 120	Static	08EL48120Y26T32	3,170	3,835	3,663	
48 x 144	Static	08EL48144Y26T32	3,464	4,246	4,032	



LC SH ← X
N/A quote 3 bases:

* \$200 NET surcharge per order for oversized pallet

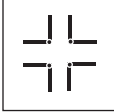

For Elite series table options, please reference pages 86-87.



Square with X-base	Top Size	Base	Model Number	3P	3K	3W
   <p>FT Flip Top X</p>	24 x 24	Static	08SQ2424X22	\$ 659	\$ 704	\$ 789
		Flip Top	08SQ2424X22FT	814	860	944
	30 x 30	Static	08SQ3030X26	822	891	986
		Flip Top	08SQ3030X26FT	890	960	1,055
	36 x 36	Static	08SQ3636X32	838	938	1,041
		Flip Top	08SQ3636X32FT	994	1,094	1,196
	42 x 42	Static	08SQ4242X36	943	1,078	1,185
		Flip Top	08SQ4242X36FT	1,174	1,310	1,416



Square with L-bases	Top Size	Base	Model Number	3P	3K	3W
   <p>LC SH 4 bases: +190 quote</p>	48 x 48	Static	08SQ4848L26	\$ 2,125	\$ 2,300	\$ 2,405
	54 x 54	Static	08SQ5454L26	2,238	2,459	2,560
	60 x 60	Static	08SQ6060L26	2,365	2,636	2,728

Square with TT-bases	Top Size	Base	Model Number	3P	3K	3W
   <p>NE nesting TT</p>	48 x 48	Static	08SQ4848TT32	\$ 1,529	\$ 1,705	\$ 1,811
		Nesting	08SQ4848TT32NE	2,554	2,726	2,829



For Elite series table options, please reference pages 86-87.

Top Size	Base	Model Number	3P	3K	3W	Round with X-base
24 x 24	Static	08RD24X22	\$ 697	\$ 758	\$ 805	 
	Flip Top	08RD24X22FT	852	913	960	
30 x 30	Static	08RD30X26	793	888	934	
	Flip Top	08RD30X26FT	950	1,043	1,089	
36 x 36	Static	08RD36X32	912	1,041	1,083	
	Flip Top	08RD36X32FT	1,067	1,196	1,238	
42 x 42	Static	08RD42X32	1,027	1,204	1,234	
	Flip Top	08RD42X32FT	1,259	1,435	1,465	
48 x 48	Static	08RD48X36	1,078	1,267	1,311	

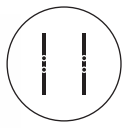

Top Size	Base	Model Number	3P	3K	3W	Round with L-bases
54 x 54	Static	08RD54L26	\$ 1,943	\$ 2,208	\$ 2,218	 
60 x 60	Static	08RD60L26	1,969	2,244	2,271	

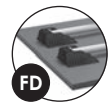

 +142 quote 3 bases:

Top Size	Base	Model Number	3P	3K	3W	Round with TT-base
48 x 48	Static	08RD48TT32	\$ 1,564	\$ 1,753	\$ 1,820	 
	Nesting	08RD48TT32NE	2,588	2,774	2,840	
54 x 54	Static	08RD54TT32	1,754	2,019	2,029	
	Nesting	08RD54TT32NE	2,775	3,034	3,044	
60 x 60	Static	08RD60TT32	1,780	2,055	2,082	
	Folding	08RD60TT32FD	2,499	2,775	2,801	
	Nesting	08RD60TT32NE	2,800	3,070	3,096	





 Folding TT Nesting TT



For Elite series table options, please reference pages 86-87.



D-shaped with T-bases	Top Size	Base	Model Number	3P	3K	3W
	24 x 36	Static	08D2436T22	\$ 879	\$ 969	\$1,037
		Nesting	08D2436T22NE	1,536	1,623	1,690
	24 x 48	Static	08D2448T22	954	1,073	1,149
		Nesting	08D2448T22NE	1,608	1,726	1,799
	24 x 60	Static	08D2460T22	1,028	1,178	1,260
		Nesting	08D2460T22NE	1,682	1,827	1,908
	24 x 72	Static	08D2472T22	1,103	1,281	1,372
		Nesting	08D2472T22NE	1,795	1,970	2,058
 Nesting T	24 x 84	Static	08D2484T22	1,262	1,469	1,567
		Nesting	08D2484T22NE	2,051	2,256	2,351
	24 x 90	Static	08D2490T22	1,298	1,522	1,623
		Nesting	08D2490T22NE	2,088	2,306	2,406
	24 x 96 *	Static	08D2496T22	1,336	1,573	1,678
		Nesting	08D2496T22NE	2,124	2,358	2,461
	30 x 48	Static	08D3048T26	1,040	1,189	1,254
		Nesting	08D3048T26NE	1,693	1,839	1,903
	30 x 60	Static	08D3060T26	1,133	1,319	1,386
		Nesting	08D3060T26NE	1,784	1,967	2,032
	30 x 72	Static	08D3072T26	1,226	1,449	1,518
		Nesting	08D3072T26NE	1,916	2,135	2,202
	30 x 84	Static	08D3084T26	1,403	1,664	1,734
		Nesting	08D3084T26NE	2,191	2,446	2,515
	30 x 90	Static	08D3090T26	1,449	1,729	1,800
		Nesting-Light	08D3090T26NE-LT	2,510	N/A	N/A
	30 x 96 *	Static	08D3096T26	1,497	1,794	1,866
		Nesting-Light	08D3096T26NE-LT	2,574	N/A	N/A
	36 x 48	Static	08D3648T26	1,115	1,293	1,348
		Nesting	08D3648T26NE	1,766	1,941	1,994
	36 x 60	Static	08D3660T26	1,226	1,449	1,500
		Nesting	08D3660T26NE	1,961	2,180	2,230
	36 x 72	Static	08D3672T26	1,338	1,606	1,652
		Nesting	08D3672T26NE	2,182	2,446	2,491
	36 x 84	Static	08D3684T26	1,533	1,846	1,889
		Nesting-Light	08D3684T26NE-LT	2,624	N/A	N/A
	36 x 90	Static	08D3690T26	1,589	1,924	1,965
		Nesting-Light	08D3690T26NE-LT	2,701	N/A	N/A
	36 x 96 *	Static	08D3696T26	1,646	2,003	2,042
		Nesting-Light	08D3696T26NE-LT	2,778	N/A	N/A



* \$200 NET surcharge per order for oversized pallet

For Elite series table options, please reference pages 86-87.

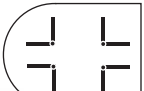
Top Size	Base	Model Number	3P	3K	3W	D-shaped with TT-bases
42 x 60	Static	08D4260TT32	\$ 2,092	\$ 2,492	\$ 2,422	  
	Nesting	08D4260TT32NE	3,106	3,499	3,430	
42 x 72	Static	08D4272TT32	2,092	2,492	2,451	
	Nesting	08D4272TT32NE	3,106	3,499	3,458	
48 x 60	Static	08D4860TT32	2,134	2,551	2,480	
	Nesting	08D4860TT32NE	3,147	3,556	3,485	
48 x 72	Static	08D4872TT32	2,134	2,551	2,509	
	Nesting	08D4872TT32NE	3,147	3,556	3,515	

Top Size	Base	Model Number	3P	3K	3W	D-shaped with Y & T-bases
42 x 60	Static	08D4260Y32T32	\$ 1,962	\$ 2,362	\$ 2,292	 
42 x 72	Static	08D4272Y32T32	1,962	2,362	2,321	
42 x 84	Static	08D4284Y32T32	2,077	2,490	2,469	
42 x 90	Static	08D4290Y32T32	2,152	2,594	2,566	
42 x 96 *	Static	08D4296Y32T32	2,225	2,697	2,661	
48 x 60	Static	08D4860Y36T36	2,056	2,473	2,402	
48 x 72	Static	08D4872Y36T36	2,056	2,473	2,431	
48 x 84	Static	08D4884Y36T36	2,140	2,557	2,545	
48 x 90	Static	08D4890Y36T36	2,215	2,661	2,641	
48 x 96 *	Static	08D4896Y36T36	2,289	2,765	2,738	

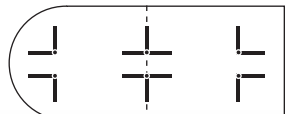

Top Size	Base	Model Number	3P	3K	3W	D-shaped with L-bases
54 x 54	Static	08D5454L26	\$ 2,609	\$ 2,976	\$ 2,938	  <p>LC SH ← ⊗ +190 quote 4 bases:</p>
54 x 60	Static	08D5460L26	2,663	3,054	3,014	
54 x 72	Static	08D5472L26	2,692	3,093	3,074	
54 x 84	Static	08D5484L26	2,971	3,451	3,402	
54 x 90	Static	08D5490L26	2,971	3,451	3,417	
54 x 96 *	Static	08D5496L26	2,971	3,451	3,432	
60 x 60	Static	08D6060L26	2,617	2,990	2,975	
60 x 72	Static	08D6072L26	2,766	3,198	3,168	
60 x 84	Static	08D6084L26	3,055	3,567	3,506	
60 x 90	Static	08D6090L26	3,055	3,567	3,521	
60 x 96 *	Static	08D6096L26	3,055	3,567	3,536	



Top Size	Base	Model Number	3P	3K	3W	D-shaped with L & Y-bases
54 x 120	Static	08D54120L26Y26	\$ 4,743	\$ 5,537	\$ 5,343	  <p>LC SH ← ⊗ N/A N/A 3 bases:</p>
54 x 144	Static	08D54144L26Y26	4,940	5,811	5,617	
60 x 120	Static	08D60120L26Y26	4,777	5,583	5,390	
60 x 144	Static	08D60144L26Y26	4,977	5,864	5,670	

* \$200 NET surcharge per order for oversized pallet

For Elite series table options, please reference pages 86-87.

Half Round with T-bases	Top Size	Base	Model Number	3P	3K	3W
 	24 x 48	Static	08HR2448T18	\$ 957	\$ 1,078	\$ 1,140
		Nesting	08HR2448T18NE	1,612	1,730	1,791
	30 x 60	Static	08HR3060T22	1,123	1,310	1,360
		Nesting	08HR3060T22NE	1,774	1,958	2,007
	36 x 72	Static	08HR3672T26	1,336	1,604	1,632
		Nesting	08HR3672T26NE	2,110	2,372	2,400

Trapezoid with T-bases	Top Size	Base	Model Number	3P	3K	3W
 	24 x 48	Static	08TZ2448T18	\$ 948	\$ 1,064	\$ 1,129
		24 x 72	Static	08TZ2472T18	1,137	1,329
	Nesting		08TZ2472T18NE	1,788	1,976	2,058
	30 x 60	Static	08TZ3060T22	1,074	1,241	1,306
		Nesting	08TZ3060T22NE	1,726	1,889	1,953
	36 x 72	Static	08TZ3672T26	1,310	1,567	1,603
Nesting		08TZ3672T26NE	2,084	2,336	2,370	

Squircle with X-base	Top Size	Base	Model Number	3P	3K	3W
 	24 x 24	Static	08SL24X22	\$ 870	\$ 999	\$ 1,020
		Flip Top	08SL24X22FT	1,025	1,154	1,175
	30 x 30	Static	08SL30X26	939	1,091	1,126
		Flip Top	08SL30X26FT	1,095	1,248	1,281
	36 x 36	Static	08SL36X32	1,032	1,209	1,254
		Flip Top	08SL36X32FT	1,187	1,364	1,410
42 x 42	Static	08SL42X36	1,118	1,322	1,377	
	Flip Top	08SL42X36FT	1,350	1,554	1,608	

For Elite series table options, please reference pages 86-87.

For Elite series table options, please reference pages 86-87.



tablex

17 app
price list
Effective May 16, 2022

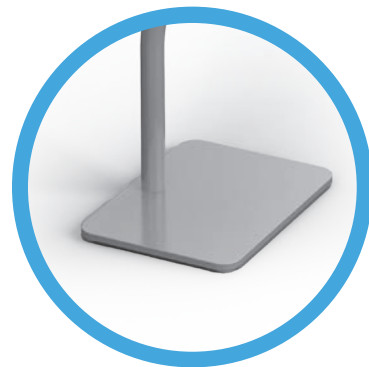

App Styles

Grab your laptop or tablet and pull up the App table. These small, lightweight tables are perfect for casual areas in the workplace or school.

20-lb weight limit.



Height Adjustability

We offer the ultimate in work mobility with our App height adjustable table. The cutaway, crescent-shaped base allows you to pull up close to any seating option, and the smooth, lever-less height adjustment will make the use of your personal device truly comfortable.

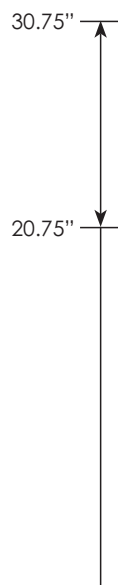

app

CUP Slide-Out Cup Holder can be added for \$60

App Base Styles



QD-B



QD-S



D



C-AH

App .75" Edge Options

(corresponds with 2 columns of pricing)

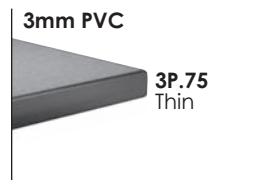

3mm PVC

3P.75
Thin



3mm Wood

3W.75
Thin

App Top Shapes



Soft Rectangle
p.105



Round
p.105

Top Size	Base	Model Number	3P.75	3W.75	Soft Rectangle with Rectangular Base
12 x 18	Static	17RC1218QD912-B	\$ 487	\$ 578	

Overall height: 26"

Top Size	Base	Model Number	3P.75	3W.75	Soft Rectangle with Square Base
12 x 18	Static	17RC1218QD912-S	487	578	

Overall height: 26"

Top Size	Base	Model Number	3P.75	3W.75	Round with Disc Base
18 x 18	Static	17RD18D12	450	534	

Overall height: 26"

Top Size	Base	Model Number	3P.75	3W.75	Soft Rectangle with Crescent Base
12 x 18	Adj.	17RC1218C-AH	780	866	

Overall height range: 20.75-30.75"

Top Size	Base	Model Number	3P.75	3W.75	Round with Crescent Base
18 x 18	Adj.	17RD18C-AH	742	826	

Overall height range: 20.75-30.75"

tablex

33 element
price list
Effective May 16, 2022





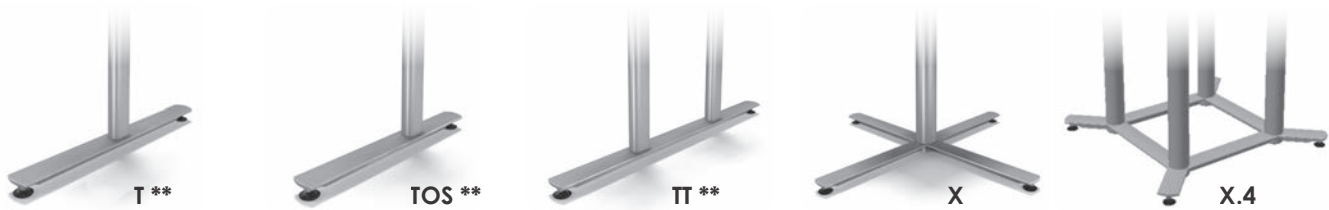

Low profile and lightweight aluminum construction makes Element a great mobile solution. Pair it up with TableX lightweight tops to create table configurations that are easy to handle.

Element Base Styles



** Due to a supply disruption our oval aluminum column as above** will be standard with a 2" round steel column. The main bar, or foot, will remain the same; this only affects the column, and will not affect the price of the table.

Element Options

<p>Standard Plastic Glides</p>  <p>Locking Casters</p>  <p>Concealed Casters</p> 	<p>LC Locking Casters can be added to any table for \$105 per set of four.</p> <p>CCG Concealed Casters available on one T-base for \$130 per table. Standard glides on opposite base.</p> <p>FD Folding Bases priced accordingly with standard glides.</p> <p>NE Nesting Tables priced accordingly with locking casters.</p> <p>FT Flip Tops available on X-based tables and are priced with standard glides.</p>	<p>OS Offset T-bases available for \$37 per table. Offset is not available on 18"d tables or 30"d nesting tables less than 60" wide.</p> <p>CH Chrome Finish is not available on Element tables.</p> <p>WM Wire Management Built-in wire management is not available on Element tables.</p> <p>WM/LC Wire Management Leg Covers Call customer service for available options</p>	<p>SH Special Height can be added to any X-based table: + \$68 per column for heights > 29" - heights < 29" are not available Special heights are not available on T or TT-bases.</p> <p>FR Footring is not available on Element series.</p> <p>PB Powerbox Mounting Plate is not available on Element tables.</p>
--	--	---	--

Element Height Adjustable Options

Height adjustability only available on Element Solo products. See page 118.

Element Top Shapes



Rectangle
p.110

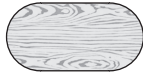

Racetrack
p.112

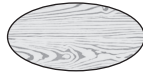

Elliptical
p.112



D-shaped
p.113



Square
p.114



Round
p.115



Half Round
p.116



Trapezoid
p.116



Squircle
p.116

Element Top Options

QG Quick-Connect Ganging Brackets can be added to any table for \$42 (includes 4 connectors per table).

GN Ganging Plates & Knobs can be added to most table shapes for \$42 (includes 2 plates and 8 knobs per table).

GR Grommets can be added to any table for \$42 each. To see specific locations, see page 217.





RC 3" Radius Corners can be added to any table for \$58.

LT Lightweight Tops can be added to any square or rectangular table for \$121.

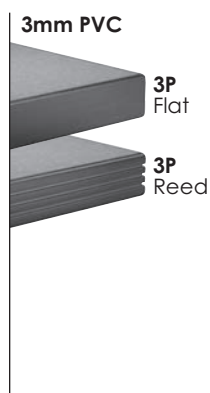



Element Edge Options



(corresponds with 3 columns of pricing)



Rectangular with T-bases	Top Size	Base	Model Number	3P	3K	3W
   	18 x 36	Static	33TC1836T16	\$ 640	\$ 691	\$ 786
		Nesting	33TC1836T18NE	1,300	1,351	1,443
	18 x 48	Static	33TC1848T16	682	749	861
		Folding	33TC1848T16FD	994	1,062	1,174
		Nesting	33TC1848T18NE	1,341	1,407	1,518
	18 x 60	Static	33TC1860T16	723	808	937
		Folding	33TC1860T16FD	1,048	1,133	1,263
		Nesting	33TC1860T18NE	1,382	1,465	1,591
	18 x 72	Static	33TC1872T16	765	866	1,012
		Folding	33TC1872T16FD	1,090	1,191	1,337
		Nesting	33TC1872T18NE	1,647	1,746	1,889
	20 x 36	Static	33TC2036T18	680	748	835
		Nesting	33TC2036T18NE	1,340	1,406	1,493
	20 x 48	Static	33TC2048T18	734	825	926
		Folding	33TC2048T18FD	1,047	1,137	1,237
		Nesting	33TC2048T18NE	1,394	1,481	1,580
	20 x 60	Static	33TC2060T18	761	859	982
		Folding	33TC2060T18FD	1,085	1,185	1,308
Nesting		33TC2060T18NE	1,418	1,516	1,636	
20 x 72	Static	33TC2072T18	808	926	1,064	
	Folding	33TC2072T18FD	1,132	1,251	1,390	
	Nesting	33TC2072T18NE	1,689	1,804	1,940	
24 x 36	Static	33TC2436T22	680	748	846	
	Nesting	33TC2436T22NE	1,340	1,406	1,502	
24 x 48	Static	33TC2448T22	734	825	935	
	Folding	33TC2448T22FD	1,047	1,137	1,248	
	Nesting	33TC2448T22NE	1,394	1,481	1,590	
24 x 60	Static	33TC2460T22	761	859	993	
	Folding	33TC2460T22FD	1,085	1,185	1,318	
	Nesting	33TC2460T22NE	1,418	1,516	1,646	
24 x 72	Static	33TC2472T22	808	926	1,074	
	Folding	33TC2472T22FD	1,132	1,251	1,399	
	Nesting	33TC2472T22NE	1,689	1,804	1,950	
30 x 36	Static	33TC3036T26	724	808	909	
	Nesting	33TC3036T26NE	1,383	1,465	1,564	
30 x 48	Static	33TC3048T26	792	902	1,013	
	Folding	33TC3048T26FD	1,105	1,215	1,325	
	Nesting	33TC3048T26NE	1,449	1,559	1,666	
30 x 60	Static	33TC3060T26	813	933	1,065	
	Folding	33TC3060T26FD	1,139	1,257	1,391	
	Nesting	33TC3060T26NE	1,470	1,587	1,717	

For Element series table options, please reference pages 108-109.

Top Size	Base	Model Number	3P	3K	3W	Rectangular with T-bases
30 x 72	Static	33TC3072T26	\$ 866	\$1,006	\$1,153	   FD Folding T  NE Nesting T
	Folding	33TC3072T26FD	1,191	1,332	1,478	
	Nesting	33TC3072T26NE	1,746	1,884	2,027	
36 x 48	Static	33TC3648T26	846	978	1,086	
	Folding	33TC3648T26FD	1,159	1,290	1,398	
	Nesting	33TC3648T26NE	1,628	1,758	1,864	
36 x 60	Static	33TC3660T26	927	1,090	1,205	
	Folding	33TC3660T26FD	1,252	1,416	1,529	
	Nesting	33TC3660T26NE	1,779	1,941	2,052	
36 x 72	Static	33TC3672T26	977	1,162	1,290	
	Folding	33TC3672T26FD	1,302	1,487	1,615	
	Nesting	33TC3672T26NE	1,855	2,036	2,161	

Top Size	Base	Model Number	3P	3K	3W	Rectangular with TT-bases
42 x 60	Static	33TC4260TT30	\$1,310	\$1,503	\$1,610	 
42 x 72	Static	33TC4272TT30	1,406	1,637	1,746	
48 x 60	Static	33TC4860TT36	1,385	1,588	1,703	
48 x 72	Static	33TC4872TT36	1,538	1,802	1,900	

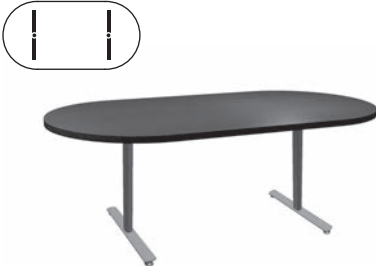

For Element series table options, please reference pages 108-109.

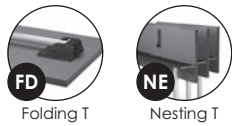

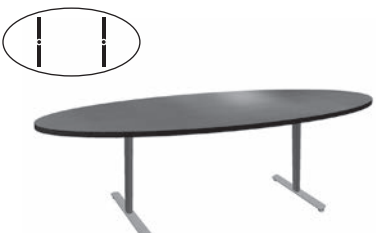
Racetrack with T-bases	Top Size	Base	Model Number	3P	3K	3W
	36 x 60	Static	33RT3660T26	\$ 1,186	\$ 1,455	\$ 1,453
		Nesting	33RT3660T26NE	1,963	2,225	2,223
	36 x 72	Static	33RT3672T26	1,186	1,455	1,482
		Folding	33RT3672T26FD	1,511	1,780	1,808
		Nesting	33RT3672T26NE	2,034	2,298	2,324



Elliptical with T-bases	Top Size	Base	Model Number	3P	3K	3W
	30 x 54	Static	33EL3054T22	\$ 935	\$ 1,105	\$ 1,141
	30 x 60	Static	33EL3060T22	980	1,168	1,202
	36 x 60	Static	33EL3660T26	1,079	1,304	1,321
	36 x 72	Static	33EL3672T26	1,186	1,455	1,463

For Element series table options, please reference pages 108-109.



Top Size	Base	Model Number	3P	3K	3W	D-shaped with T-bases
24 x 36	Static	33D2436T22	\$ 734	\$ 824	\$ 892	  
	Nesting	33D2436T22NE	1,394	1,481	1,548	
24 x 48	Static	33D2448T22	809	928	1,004	
	Nesting	33D2448T22NE	1,466	1,583	1,657	
24 x 60	Static	33D2460T22	884	1,033	1,116	
	Nesting	33D2460T22NE	1,540	1,686	1,767	
24 x 72	Static	33D2472T22	958	1,137	1,227	
	Nesting	33D2472T22NE	1,652	1,827	1,917	
30 x 48	Static	33D3048T26	887	1,036	1,101	
	Nesting	33D3048T26NE	1,543	1,689	1,753	
30 x 60	Static	33D3060T26	980	1,166	1,233	
	Nesting	33D3060T26NE	1,634	1,817	1,882	
30 x 72	Static	33D3072T26	1,074	1,296	1,364	
	Nesting	33D3072T26NE	1,766	1,985	2,052	
36 x 48	Static	33D3648T26	961	1,140	1,194	
	Nesting	33D3648T26NE	1,615	1,791	1,844	
36 x 60	Static	33D3660T26	1,074	1,296	1,347	
	Nesting	33D3660T26NE	1,811	2,030	2,079	
36 x 72	Static	33D3672T26	1,185	1,453	1,499	
	Nesting	33D3672T26NE	2,032	2,296	2,341	

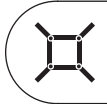

Top Size	Base	Model Number	3P	3K	3W	D-shaped with TT-bases
42 x 60	Static	33D4260TT30	\$ 1,829	\$ 2,229	\$ 2,158	 
42 x 72	Static	33D4272TT30	1,829	2,229	2,188	
48 x 60	Static	33D4860TT36	1,920	2,336	2,264	
48 x 72	Static	33D4872TT36	1,920	2,336	2,295	



Top Size	Base	Model Number	3P	3K	3W	D-shaped with 4-column X-base
54 x 54	Static	33D5454X36.4	\$ 2,251	\$ 2,618	\$ 2,580	 
60 x 60	Static	33D6060X42.4	2,298	2,670	2,656	



SH +272 X.4:

For Element series table options, please reference pages 108-109.



Square with X-base	Top Size	Base	Model Number	3P	3K	3W
   <p>Flip Top X</p>	24 x 24	Static	33SQ2424X22	\$ 679	\$ 724	\$ 808
		Flip Top	33SQ2424X22FT	834	879	964
	30 x 30	Static	33SQ3030X26	755	826	920
		Flip Top	33SQ3030X26FT	911	981	1,077
	36 x 36	Static	33SQ3636X32	845	944	1,047
		Flip Top	33SQ3636X32FT	1,000	1,100	1,203
	42 x 42	Static	33SQ4242X36	964	1,099	1,205
		Flip Top	33SQ4242X36FT	1,195	1,330	1,436



Square with 4-column X-base	Top Size	Base	Model Number	3P	3K	3W
 	48 x 48	Static	33SQ4848X36.4	\$ 1,767	\$ 1,942	\$ 2,047
	54 x 54	Static	33SQ5454X36.4	1,880	2,100	2,202
	60 x 60	Static	33SQ6060X42.4	2,045	2,317	2,409





 X.4: +272

Square with TT-bases	Top Size	Base	Model Number	3P	3K	3W
 	48 x 48	Static	33SQ4848TT26	\$ 1,266	\$ 1,441	\$ 1,546

For Element series table options, please reference pages 108-109.

Top Size	Base	Model Number	3P	3K	3W	Round with X-base
24 x 24	Static	33RD24X22	\$ 717	\$ 777	\$ 825	 
	Flip Top	33RD24X22FT	872	933	980	
30 x 30	Static	33RD30X26	815	909	955	
	Flip Top	33RD30X26FT	971	1,064	1,110	
36 x 36	Static	33RD36X32	918	1,047	1,089	
	Flip Top	33RD36X32FT	1,074	1,203	1,246	
42 x 42	Static	33RD42X32	1,035	1,210	1,241	
	Flip Top	33RD42X32FT	1,266	1,441	1,473	
48 x 48	Static	33RD48X36	1,099	1,288	1,332	



Top Size	Base	Model Number	3P	3K	3W	Round with 4-column X-base
54 x 54	Static	33RD54X36.4	\$ 1,991	\$ 2,256	\$ 2,266	 
60 x 60	Static	33RD60X36.4	2,018	2,293	2,319	

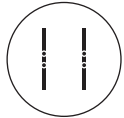

 +272 ← 

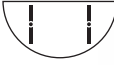

Top Size	Base	Model Number	3P	3K	3W	Round with TT-base
48 x 48	Static	33RD48TT26	\$ 1,300	\$ 1,488	\$ 1,533	 
54 x 54	Static	33RD54TT30	1,489	1,755	1,766	
60 x 60	Static	33RD60TT30	1,517	1,792	1,818	
	Folding	33RD60TT30FD	2,236	2,511	2,537	



For Element series table options, please reference pages 108-109.

Half Round with T-bases	Top Size	Base	Model Number	3P	3K	3W
   <p>Nesting T</p>	18 x 36	Static	33HR1836T16	\$ 745	\$ 838	\$ 882
	24 x 48	Static	33HR2448T16	812	933	995
		Nesting	33HR2448T16NE	1,469	1,588	1,649
	30 x 60	Static	33HR3060T22	978	1,165	1,215
		Nesting	33HR3060T22NE	1,632	1,815	1,864
	36 x 72	Static	33HR3672T26	1,184	1,451	1,479
Nesting		33HR3672T26NE	1,960	2,221	2,249	

Trapezoid with T-bases	Top Size	Base	Model Number	3P	3K	3W
   <p>Nesting T</p>	24 x 48	Static	33TZ2448T18	\$ 803	\$ 919	\$ 984
	24 x 72	Static	33TZ2472T18	992	1,184	1,268
		Nesting	33TZ2472T18NE	1,645	1,834	1,917
	30 x 60	Static	33TZ3060T22	929	1,096	1,161
		Nesting	33TZ3060T22NE	1,584	1,748	1,812
	36 x 72	Static	33TZ3672T26	1,157	1,414	1,449
Nesting		33TZ3672T26NE	1,934	2,186	2,220	

Squircle with X-base	Top Size	Base	Model Number	3P	3K	3W
 	24 x 24	Static	33SL24X22	\$ 889	\$ 1,019	\$ 1,040
		Flip Top	33SL24X22FT	1,044	1,174	1,195
	30 x 30	Static	33SL30X26	960	1,113	1,147
		Flip Top	33SL30X26FT	1,116	1,269	1,302
	36 x 36	Static	33SL36X32	1,039	1,215	1,260
		Flip Top	33SL36X32FT	1,194	1,371	1,416
42 x 42	Static	33SL42X36	1,139	1,343	1,397	
	Flip Top	33SL42X36FT	1,370	1,574	1,628	

For Element series table options, please reference pages 108-109.

For Element series table options, please reference pages 108-109.

Solo Tables: Static, Counterbalanced, and/or Flip Top

Element Solo tables are designed with a single user in mind. Perfect for the classroom, these tables come in a variety of configurations that make them incredibly versatile.

Standard Models:



Static

The standard model is a simple, 29" high table with levelers. Specify with locking casters and the overall height remains 29".



Flip Top

A standard 29" high table with a flip top mechanism for easier storage. Specify with locking casters and the overall height remains 29".



Counterbalanced

A height adjustable column takes this top from 26.75-44.25". Specify with locking casters and the height range increases by 2".



Counterbalanced + Flip Top

A height adjustable column takes this top from 26.75-44.25". Includes a flip top mechanism for easier storage. Specify with locking casters and the height range increases by 1.5".

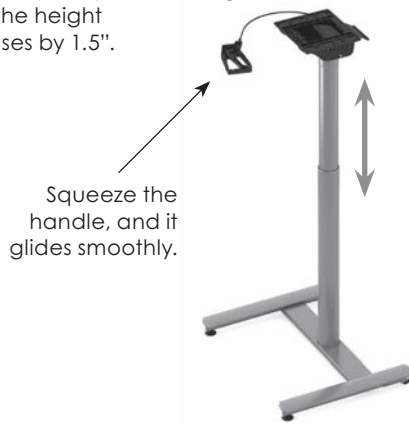

Solo Options

CCG Concealed Caster (non locking) / Glide Combo creates a wheelbarrow effect. Available on Element Solo H-bases for \$130 list.

LC1.5 1.5" Low Profile Locking Casters can be added to any table for \$105 per set of four

MARKER Markerboard Top can be added for \$105 per table (see page 16 for details)

CUP Slide-Out Cup Holder can be added for \$60

FT-GT Flip top w/ 15° tilt lock option add \$31 to the FT Flip Top price

PS Acrylic Pencil Stop for tilt lock option can be added for \$30

Element Solo Top Shapes



Rectangle p.119



Trapezoid p.119

Element Solo Base Styles



H

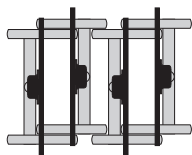





H-base features face-to-face offset nesting

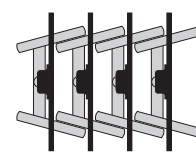









A



A-base features in-line nesting

Top Size	Base	Model Number	3P	3K	3W	Solo Rectangle with H-base
20 x 30	Static	33TC2030H1830	\$ 744	\$ 801	\$ 881	   <p>FT Flip Top X</p>  <p>BL Counter-balanced Ht. Adjustable</p>
	Flip Top	33TC2030H1830FT	974	1,031	1,111	
	Count Bal	33TC2030H1830BL	1,363	1,420	1,501	
	Bal + Flip	33TC2030H1830BLFT	1,491	1,548	1,629	
20 x 36	Static	33TC2036H1830	771	839	927	
	Flip Top	33TC2036H1830FT	1,001	1,068	1,157	
	Count Bal	33TC2036H1830BL	1,391	1,458	1,546	
	Bal + Flip	33TC2036H1830BLFT	1,519	1,587	1,674	
24 x 30	Static	33TC2430H1830	744	801	892	
	Flip Top	33TC2430H1830FT	974	1,031	1,121	
	Count Bal	33TC2430H1830BL	1,363	1,420	1,510	
	Bal + Flip	33TC2430H1830BLFT	1,491	1,548	1,640	
24 x 36	Static	33TC2436H1830	771	839	937	
	Flip Top	33TC2436H1830FT	1,001	1,068	1,166	
	Count Bal	33TC2436H1830BL	1,391	1,458	1,556	
	Bal + Flip	33TC2436H1830BLFT	1,519	1,587	1,684	

Top Size	Base	Model Number	3P	3K	3W	Solo Rectangle with A-base
20 x 30	Static	33TC2030A1830	\$ 744	\$ 801	\$ 881	   <p>FT Flip Top X</p>  <p>BL Counter-balanced Ht. Adjustable</p>
	Flip Top	33TC2030A1830FT	974	1,031	1,111	
	Count Bal	33TC2030A1830BL	1,363	1,420	1,501	
	Bal + Flip	33TC2030A1830BLFT	1,491	1,548	1,629	
24 x 30	Static	33TC2430A1830	744	801	892	
	Flip Top	33TC2430A1830FT	974	1,031	1,121	
	Count Bal	33TC2430A1830BL	1,363	1,420	1,510	
	Bal + Flip	33TC2430A1830BLFT	1,491	1,548	1,640	

Top Size	Base	Model Number	3P	3K	3W	Solo Trapezoid with A-base
24 x 36	Static	33TZ2436A1830	\$ 894	\$ 1,011	\$ 1,071	   <p>FT Flip Top X</p>  <p>BL Counter-balanced Ht. Adjustable</p>
	Flip Top	33TZ2436A1830FT	1,124	1,239	1,300	
	Count Bal	33TZ2436A1830BL	1,512	1,629	1,690	
	Bal + Flip	33TZ2436A1830BLFT	1,642	1,758	1,818	

tablex

40 justice
price list
Effective May 16, 2022



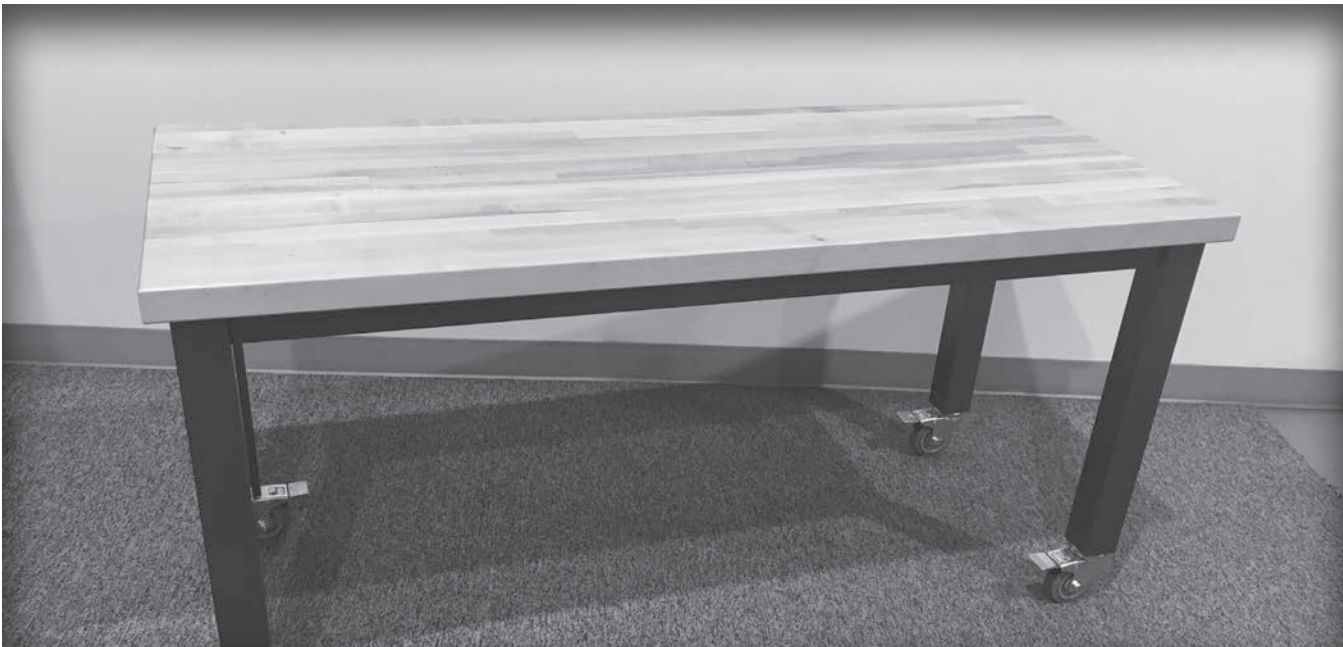

A rigid apron frame and square column legs make Justice a heavy-duty choice when long-lasting durability is a requirement. Its unique design gives it the stability to handle a 500 lb. weight capacity. Justice is available in three different heights and offers mobility when specified with industrial locking casters.

Justice Rigid Frame with Square Column Legs

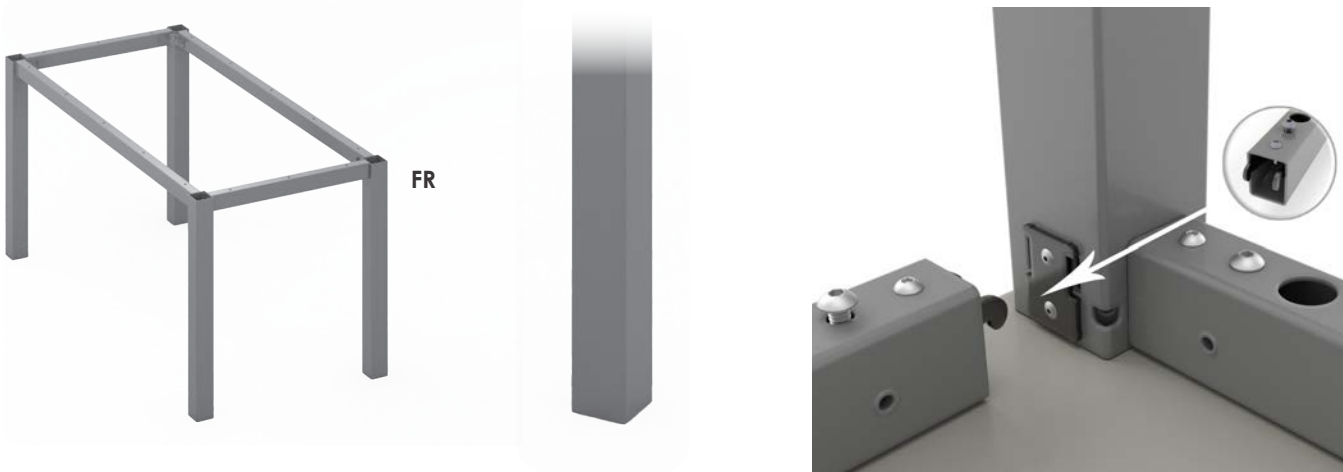

Justice Options

<p>Standard Glides</p> <p>Industrial Locking Casters</p>	<p>ILC Industrial Locking Casters can be added to any Justice table for \$200 per set of four.</p> <p>FD Folding Bases are not available on Justice tables.</p> <p>NE Nesting Tables are not available in the Justice series.</p>	<p>FT Flip Tops are not available on Justice tables.</p> <p>WM Wire Management Built-in wire management is not available on Justice tables.</p> <p>WMLC Magnetic Wire Management Leg Covers Magnetically attaches onto any square leg and are \$67 each.</p>	<p>CH Chrome Finish is not available on Justice tables.</p> <p>SH Special Heights of 36" or 42" are available on Justice tables for \$115 per table.</p> <p>Other custom heights are not available on Justice.</p>
--	--	---	--

Justice Top Shapes

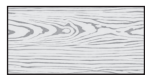

Rectangle
p.124



Square
p.125



Round
p.125



Squircle
p.125



Boat
p.126



Racetrack
p.126



Elliptical
p.126



D-shaped
p.127

Justice Top Options

LT **Lightweight Tops**
can be added to any table for \$121.

GR **Grommets**
can be added to any table for \$42 each. To see specific locations, see page 217. Locations may be adjusted to avoid Justice frame.

BB **Maple Butcher Block**
is 1.75" thick with a food-grade clearcoat finish. Available in specific sizes with no grommets and clamp-on power only. Clamp-on power (Burelé) information can be found on page 209.

call for pricing

Justice Edge Options

(corresponds with 3 columns of pricing)

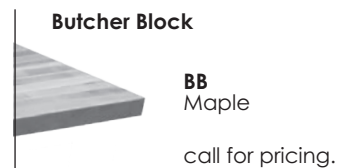
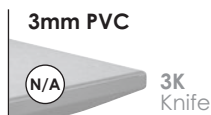







Rectangular with Frame & Columns	Top Size	Base	Model Number	3P	3K	3W
	24 x 36	Static	40TC2436FR2234	1,145	N/A	1,310
	24 x 48	Static	40TC2448FR2246	1,227	N/A	1,427
	24 x 60	Static	40TC2460FR2258	1,258	N/A	1,490
	24 x 72	Static	40TC2472FR2270	1,336	N/A	1,603
	24 x 84	Static	40TC2484FR2270	1,427	N/A	1,733
	24 x 90	Static	40TC2490FR2270	1,482	N/A	1,808
	24 x 96 *	Static	40TC2496FR2270	1,482	N/A	1,822
	30 x 36	Static	40TC3036FR2834	1,192	N/A	1,376
	30 x 48	Static	40TC3048FR2846	1,278	N/A	1,499
	30 x 60	Static	40TC3060FR2858	1,320	N/A	1,572
	30 x 72	Static	40TC3072FR2870	1,403	N/A	1,690
	30 x 84	Static	40TC3084FR2870	1,532	N/A	1,862
	30 x 90	Static	40TC3090FR2870	1,601	N/A	1,951
	30 x 96 *	Static	40TC3096FR2870	1,601	N/A	1,966
	36 x 48	Static	40TC3648FR3446	1,341	N/A	1,582
	36 x 60	Static	40TC3660FR3458	1,449	N/A	1,728
	36 x 72	Static	40TC3672FR3470	1,527	N/A	1,840
	36 x 84	Static	40TC3684FR3470	1,638	N/A	1,991
	36 x 90	Static	40TC3690FR3470	1,718	N/A	2,094
	36 x 96 *	Static	40TC3696FR3470	1,718	N/A	2,109
	42 x 60	Static	40TC4260FR4058	1,511	N/A	1,812
	42 x 72	Static	40TC4272FR4070	1,627	N/A	1,966
	42 x 84	Static	40TC4284FR4070	1,719	N/A	2,097
	42 x 90	Static	40TC4290FR4070	1,809	N/A	2,211
	42 x 96 *	Static	40TC4296FR4070	1,809	N/A	2,225
	48 x 60	Static	40TC4860FR4658	1,562	N/A	1,879
	48 x 72	Static	40TC4872FR4670	1,741	N/A	2,104
	48 x 84	Static	40TC4884FR4670	1,751	N/A	2,144
	48 x 90	Static	40TC4890FR4670	1,842	N/A	2,258
	48 x 96 *	Static	40TC4896FR4670	1,842	N/A	2,273

* \$200 NET surcharge per order for oversized pallet

For all Justice series table options, please reference pages 122-123.

Top Size	Base	Model Number	3P	3K	3W	Square with Frame & Columns
24 x 24	Static	40SQ2424FR2222	\$ 1,071	N/A	\$ 1,202	 
30 x 30	Static	40SQ3030FR2828	1,149	N/A	1,314	
36 x 36	Static	40SQ3636FR3434	1,245	N/A	1,447	
42 x 42	Static	40SQ4242FR4040	1,356	N/A	1,598	
48 x 48	Static	40SQ4848FR4646	1,467	N/A	1,749	
54 x 54	Static	40SQ5454FR4646	1,582	N/A	1,903	
60 x 60	Static	40SQ6060FR4646	1,708	N/A	2,072	

Top Size	Base	Model Number	3P	3K	3W	Round with Frame & Columns
36 x 36	Static	40RD36FR2222	\$ 1,280	N/A	\$ 1,453	 
42 x 42	Static	40RD42FR2828	1,413	N/A	1,620	
48 x 48	Static	40RD48FR2828	1,445	N/A	1,678	
54 x 54	Static	40RD54FR3434	1,657	N/A	1,932	
60 x 60	Static	40RD60FR4040	1,707	N/A	2,008	

Top Size	Base	Model Number	3P	3K	3W	Squircle with Frame & Columns
30 x 30	Static	40SL30FR2222	\$ 1,338	N/A	\$ 1,493	 
36 x 36	Static	40SL36FR2222	1,401	N/A	1,585	
42 x 42	Static	40SL42FR2828	1,485	N/A	1,699	
48 x 48	Static	40SL48FR3434	1,589	N/A	1,835	

For all Justice series table options, please reference pages 122-123.

Boat-shaped with Frame & Columns

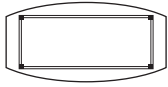

Top Size	Base	Model Number	3P	3K	3W
30 x 42 x 84	Static	40BT3084FR2870	\$ 1,962	N/A	\$ 2,319
30 x 42 x 90	Static	40BT3090FR2870	2,091	N/A	2,476
30 x 42 x 96 *	Static	40BT3096FR2870	2,091	N/A	2,491
36 x 48 x 84	Static	40BT3684FR3470	2,103	N/A	2,481
36 x 48 x 90	Static	40BT3690FR3470	2,250	N/A	2,657
36 x 48 x 96 *	Static	40BT3696FR3470	2,250	N/A	2,672

Racetrack with Frame & Columns

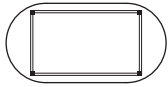

Top Size	Base	Model Number	3P	3K	3W
36 x 72	Static	40RT3672FR2846	\$ 1,673	N/A	\$ 1,969
36 x 84	Static	40RT3684FR2858	1,929	N/A	2,278
36 x 90	Static	40RT3690FR2858	2,061	N/A	2,438
36 x 96 *	Static	40RT3696FR2870	2,091	N/A	2,483
42 x 84	Static	40RT4284FR3458	1,945	N/A	2,302
42 x 90	Static	40RT4290FR3458	2,076	N/A	2,462
42 x 96 *	Static	40RT4296FR3470	2,104	N/A	2,504
48 x 84	Static	40RT4884FR4058	2,214	N/A	2,608
48 x 90	Static	40RT4890FR4058	2,214	N/A	2,622
48 x 96 *	Static	40RT4896FR4070	2,233	N/A	2,656

Elliptical with Frame & Columns

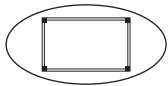

Top Size	Base	Model Number	3P	3K	3W
36 x 72	Static	40EL3672FR2234	\$ 1,648	N/A	\$ 1,924
36 x 84	Static	40EL3684FR2246	1,788	N/A	2,098
36 x 90	Static	40EL3690FR2246	1,896	N/A	2,229
36 x 96 *	Static	40EL3696FR2258	1,902	N/A	2,246
42 x 72	Static	40EL4272FR2834	1,767	N/A	2,066
42 x 84	Static	40EL4284FR2846	1,908	N/A	2,243
42 x 90	Static	40EL4290FR2846	2,043	N/A	2,403
42 x 96 *	Static	40EL4296FR2858	2,063	N/A	2,434
48 x 84	Static	40EL4884FR3446	2,196	N/A	2,570
48 x 90	Static	40EL4890FR3446	2,196	N/A	2,581
48 x 96 *	Static	40EL4896FR3458	2,222	N/A	2,620

* \$200 NET surcharge per order for oversized pallet

For all Justice series table options, please reference pages 122-123.

Top Size	Base	Model Number	3P	3K	3W	D-shaped with Frame & Columns
24 x 36	Static	40D2436FR2222	\$ 1,181	N/A	\$ 1,338	
24 x 48	Static	40D2448FR2234	1,274	N/A	1,468	
24 x 60	Static	40D2460FR2246	1,375	N/A	1,607	
24 x 72	Static	40D2472FR2258	1,456	N/A	1,725	
24 x 84	Static	40D2484FR2270	1,561	N/A	1,866	
24 x 90	Static	40D2490FR2270	1,598	N/A	1,922	
24 x 96 *	Static	40D2496FR2270	1,635	N/A	1,978	
30 x 48	Static	40D3048FR2834	1,355	N/A	1,569	
30 x 60	Static	40D3060FR2846	1,467	N/A	1,719	
30 x 72	Static	40D3072FR2858	1,581	N/A	1,873	
30 x 84	Static	40D3084FR2870	1,704	N/A	2,034	
30 x 90	Static	40D3090FR2870	1,750	N/A	2,100	
30 x 96 *	Static	40D3096FR2870	1,797	N/A	2,167	
36 x 48	Static	40D3648FR2834	1,430	N/A	1,663	
36 x 60	Static	40D3660FR2846	1,560	N/A	1,834	
36 x 72	Static	40D3672FR2858	1,692	N/A	2,007	
36 x 84	Static	40D3684FR2870	1,834	N/A	2,189	
36 x 90	Static	40D3690FR2870	1,889	N/A	2,265	
36 x 96 *	Static	40D3696FR2870	1,945	N/A	2,342	
42 x 72	Static	40D4272FR3458	2,039	N/A	2,398	
42 x 84	Static	40D4284FR3470	2,096	N/A	2,488	
42 x 90	Static	40D4290FR3470	2,171	N/A	2,585	
42 x 96 *	Static	40D4296FR3470	2,244	N/A	2,680	
48 x 72	Static	40D4872FR4646	2,072	N/A	2,447	
48 x 84	Static	40D4884FR4658	2,096	N/A	2,501	
48 x 90	Static	40D4890FR4658	2,170	N/A	2,597	
48 x 96 *	Static	40D4896FR4670	2,272	N/A	2,721	

justice

* \$200 NET surcharge per order for oversized pallet

For all Justice series table options, please reference pages 122-123.



44 primary
price list
Effective May 16, 2022

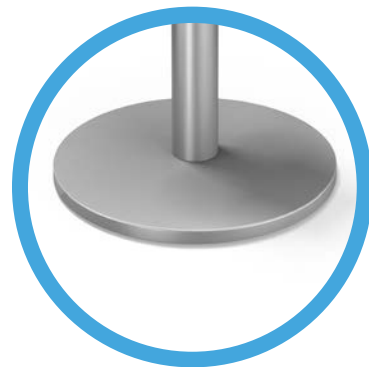



primary

Maximize your foot space with durable traditional column bases. Primary's combination of columns, disc, and drum bases offer alternatives to meet a wide array of applications.

Primary Base Styles

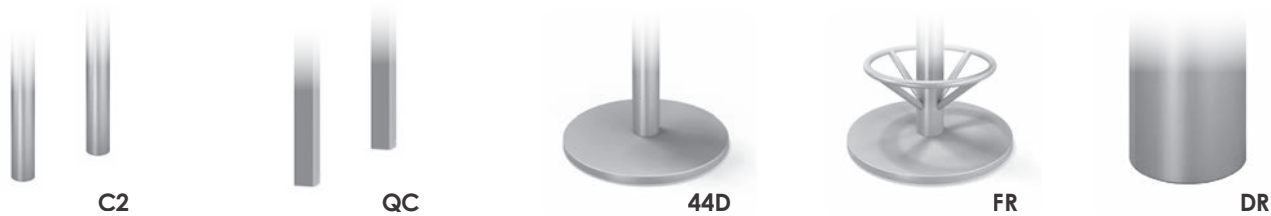

Primary Options

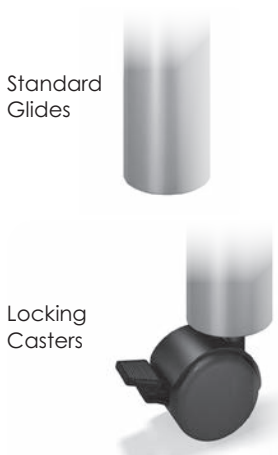

Standard Glides

Locking Casters

COR **Corner Mount Columns** available for \$70 list per table with 2" columns.

LC **Locking Casters** can be added to any table for \$105 per set of four.

QC **Square Columns** are available for an upcharge of \$47 per column.

FD **Folding Bases** are not available on Primary tables.

NE **Nesting Tables** are not available on Primary tables.

FT **Flip Tops** available some disc-based tables and are priced with standard glides.

CH **Chrome Finish** available on 2" columns only for \$45 per column. Upcharge for 44D disc bases is \$420 per base.

WM **Wire Management** Built-in wire management is available for \$132 per column.

WMLC **Wire Management Leg Covers 2"** snap onto round columns and are \$47 each.

MMLC **Magnetic Wire Management Leg Covers** Magnetically attaches onto any square leg and are \$67 each.

SH **Special Height** can be added to any table:
 + \$68 per column for heights > 29"
 + \$47 per column for heights < 29"
 Special height tables with tops larger than 36x72" must be custom quoted.

FR **Footring** available on standing height disc-bases for \$158 per base. Not available in chrome.

PB **Powerbox Mounting Plate** is available on disc bases for \$95.

Primary Height Adjustable Options

- NU Pneumatic** is available on disc bases for \$368 per table. For height option details, see page 19.
- AH Spring Clip** is available on X-bases for \$131 and on round column bases for \$525 per table. Not available in chrome. For height option details, see page 19.
- EX Manual Extended Height** is available on 2" columns for \$295 per table. For height option details, see page 19.
- BL Counterbalanced and Short Balanced** are available on disc bases. Available height adjustable finishes can be found on page 9.

Primary Top Shapes

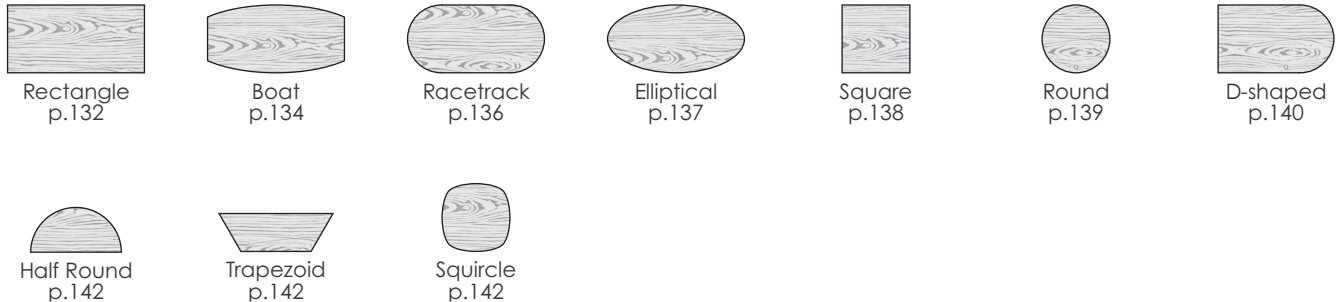



Primary Top Options

- RC 3" Radius Corners** can be added to any table for \$58.
- LT Lightweight Tops** can be added to any square or rectangular table for \$121.
- GR Grommets** can be added to any table for \$42 each. To see specific locations, see page 217.
- GN Ganging Plates & Knobs** can be added to most table shapes for \$42 (includes 2 plates and 8 knobs per table).
- QG Quick-Connect Ganging Brackets** can be added to most table shapes for \$42 (includes 4 connectors per table).

Primary Edge Options

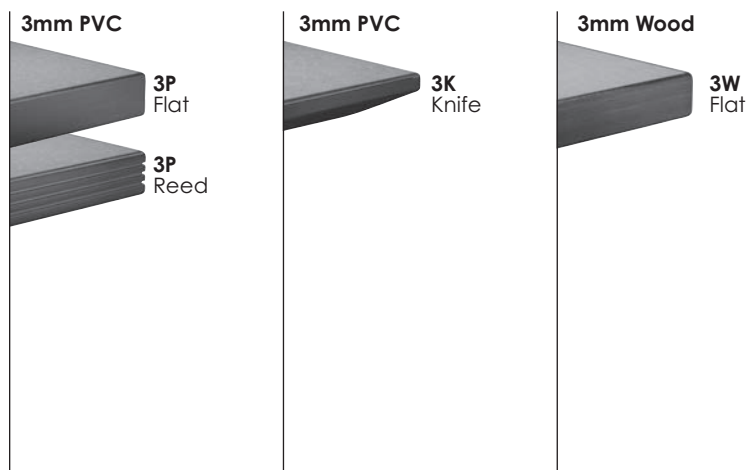
(corresponds with 3 columns of pricing)



Rectangular with Column Bases	Top Size	Base	Model Number	3P	3K	3W
	18 x 36	Static	44TC1836C2	\$ 617	\$ 667	\$ 763
	18 x 48	Static	44TC1848C2	658	726	838
	18 x 60	Static	44TC1860C2	784	869	998
	18 x 72	Static	44TC1872C2	826	927	1,073
	18 x 84	Static	44TC1884C2	867	985	1,148
	18 x 90	Static	44TC1890C2	909	1,043	1,209
	18 x 96 *	Static	44TC1896C2	909	1,043	1,224
	20 x 36	Static	44TC2036C2	657	724	812
	20 x 48	Static	44TC2048C2	711	801	901
	20 x 60	Static	44TC2060C2	821	920	1,043
	20 x 72	Static	44TC2072C2	868	986	1,125
	20 x 84	Static	44TC2084C2	960	1,115	1,255
	20 x 90	Static	44TC2090C2	1,015	1,191	1,330
	20 x 96 *	Static	44TC2096C2	1,015	1,191	1,344
	24 x 36	Static	44TC2436C2	657	724	822
	24 x 48	Static	44TC2448C2	711	801	912
	24 x 60	Static	44TC2460C2	821	920	1,054
	24 x 72	Static	44TC2472C2	868	986	1,134
	24 x 84	Static	44TC2484C2	960	1,115	1,265
	24 x 90	Static	44TC2490C2	1,015	1,191	1,340
	24 x 96 *	Static	44TC2496C2	1,015	1,191	1,355
	30 x 36	Static	44TC3036C2	698	782	881
	30 x 48	Static	44TC3048C2	765	876	985
	30 x 60	Static	44TC3060C2	870	990	1,122
30 x 72	Static	44TC3072C2	923	1,064	1,210	
30 x 84	Static	44TC3084C2	1,053	1,245	1,381	
30 x 90	Static	44TC3090C2	1,120	1,339	1,472	
30 x 96 *	Static	44TC3096C2	1,120	1,339	1,486	
36 x 48	Static	44TC3648C2	818	951	1,059	
36 x 60	Static	44TC3660C2	983	1,148	1,262	
36 x 72	Static	44TC3672C2	1,035	1,220	1,348	
36 x 84	Static	44TC3684C2	1,145	1,374	1,499	
36 x 90	Static	44TC3690C2	1,225	1,486	1,601	
36 x 96 *	Static	44TC3696C2	1,225	1,486	1,615	



* \$200 NET surcharge per order for oversized pallet

For Primary series table options, please reference pages 130-131.

Top Size	Base	Model Number	3P	3K	3W	Rectangular with 2 Disc Bases
24 x 60	Static	44TC2460D20	\$ 1,711	\$ 1,811	\$ 1,944	
24 x 72	Static	44TC2472D20	1,758	1,877	2,025	
24 x 84	Static	44TC2484D20	1,935	2,089	2,239	
24 x 90	Static	44TC2490D20	1,989	2,166	2,315	
24 x 96 *	Static	44TC2496D20	1,989	2,166	2,329	
30 x 60	Static	44TC3060D20	1,760	1,880	2,012	
30 x 72	Static	44TC3072D20	1,814	1,955	2,100	
30 x 84	Static	44TC3084D20	2,027	2,219	2,356	
30 x 90	Static	44TC3090D20	2,094	2,314	2,446	
30 x 96 *	Static	44TC3096D20	2,094	2,314	2,461	
36 x 72	Static	44TC3672D24	2,029	2,214	2,342	
36 x 84	Static	44TC3684D24	2,224	2,453	2,577	
36 x 90	Static	44TC3690D24	2,304	2,565	2,680	
36 x 96 *	Static	44TC3696D24	2,304	2,565	2,695	
42 x 72	Static	44TC4272D32	2,477	2,708	2,817	
42 x 84	Static	44TC4284D32	2,654	2,922	3,032	
42 x 90	Static	44TC4290D32	2,743	3,047	3,145	
42 x 96 *	Static	44TC4296D32	2,743	3,048	3,160	

CH +840
SH +136
← 2 disc bases: ⊗

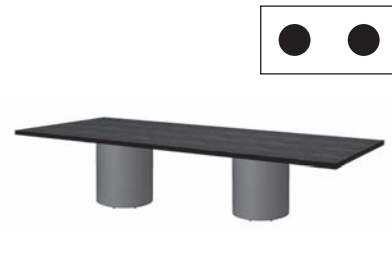
Top Size	Base	Model Number	3P	3K	3W	Rectangular with Drum Bases
30 x 60	Drum	44TC3060DR18	\$ 4,583	\$ 4,702	\$ 4,835	
30 x 72	Drum	44TC3072DR18	4,635	4,776	4,923	
30 x 84	Drum	44TC3084DR18	4,764	4,956	5,094	
30 x 90	Drum	44TC3090DR18	4,917	5,136	5,267	
30 x 96 *	Drum	44TC3096DR18	4,917	5,136	5,282	
36 x 60	Drum	44TC3660DR18	4,696	4,861	4,974	
36 x 72	Drum	44TC3672DR18	4,746	4,931	5,059	
36 x 84	Drum	44TC3684DR18	4,858	5,087	5,211	
36 x 90	Drum	44TC3690DR18	5,022	5,282	5,397	
36 x 96 *	Drum	44TC3696DR18	5,022	5,282	5,412	
42 x 72	Drum	44TC4272DR24	5,126	5,357	5,465	
42 x 84	Drum	44TC4284DR24	5,218	5,486	5,596	
42 x 90	Drum	44TC4290DR24	5,391	5,695	5,792	
42 x 96 *	Drum	44TC4296DR24	5,391	5,695	5,808	
48 x 72	Drum	44TC4872DR24	5,207	5,472	5,570	
48 x 84	Drum	44TC4884DR24	5,218	5,486	5,611	
48 x 90	Drum	44TC4890DR24	5,392	5,697	5,809	
48 x 96 *	Drum	44TC4896DR24	5,392	5,697	5,824	

* \$200 NET surcharge per order for oversized pallet

For Primary series table options, please reference pages 130-131.

primary

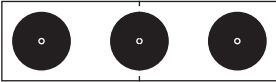
Rectangular with 3 Disc Bases	Top Size	Base	Model Number	3P	3K	3W
	42 x 120	Static	44TC42120D32(3)	\$4,030	\$4,482	\$4,543
	42 x 144	Static	44TC42144D32(3)	4,215	4,740	4,805

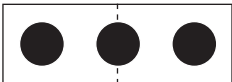

CH SH ← ⊗
 +1,260 +204 3 disc bases:

Rectangular with 3 Drum Bases	Top Size	Base	Model Number	3P	3K	3W
	42 x 120	Drum	44TC42120DR24(3)	\$8,001	\$8,453	\$8,515
	42 x 144	Drum	44TC42144DR24(3)	8,186	8,712	8,777
	48 x 120	Drum	44TC48120DR24(3)	8,013	8,469	8,542
	48 x 144	Drum	44TC48144DR24(3)	8,200	8,730	8,807



CH SH ← ⊗
 N/A N/A Drum bases:

Boat-shaped with 2 Disc Bases	Top Size	Base	Model Number	3P	3K	3W
	30 x 42 x 84	Static	44BT3084D24	\$2,560	\$2,925	\$2,918
	30 x 42 x 90	Static	44BT3090D24	2,690	3,105	3,075
	30 x 42 x 96 *	Static	44BT3096D24	2,690	3,105	3,090
	36 x 48 x 84	Static	44BT3684D32	3,021	3,436	3,399
	36 x 48 x 90	Static	44BT3690D32	3,167	3,641	3,576
	36 x 48 x 96 *	Static	44BT3696D32	3,167	3,641	3,590



⊗ → CH SH
 2 thin disc bases: +840 +136

Boat-shaped with 2 Drum Bases	Top Size	Base	Model Number	3P	3K	3W
	30 x 42 x 84	Drum	44BT3084DR18	\$5,194	\$5,558	\$5,552
	30 x 42 x 90	Drum	44BT3090DR18	5,407	5,823	5,792
	30 x 42 x 96 *	Drum	44BT3096DR18	5,407	5,823	5,807
	36 x 48 x 84	Drum	44BT3684DR24	5,584	5,999	5,963
	36 x 48 x 90	Drum	44BT3690DR24	5,815	6,289	6,224
	36 x 48 x 96 *	Drum	44BT3696DR24	5,815	6,289	6,239



⊗ → CH SH
 Drum bases: N/A N/A

* \$200 NET surcharge per order for oversized pallet

For Primary series table options, please reference pages 130-131.

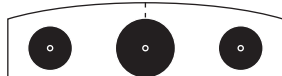
Top Size	Base	Model Number	3P	3K	3W	Boat-shaped with 3 Disc Bases
36 x 48 x 120	Static	44BT36120D243224	\$ 4,230	\$ 4,895	\$ 4,760	
36 x 48 x 144	Static	44BT36144D243224	4,524	5,305	5,142	

CH SH ← ⊗
 +1,260 +204 3 disc bases:



primary

Top Size	Base	Model Number	3P	3K	3W	Boat-shaped with 3 Drum Bases
36 x 48 x 120	Drum	44BT36120DR182418	\$ 8,271	\$ 8,936	\$ 8,802	
36 x 48 x 144	Drum	44BT36144DR182418	8,565	9,347	9,184	

CH SH ← ⊗
 N/A N/A Drum bases:



For Primary series table options, please reference pages 130-131.

Racetrack with 2 Disc Bases	Top Size	Base	Model Number	3P	3K	3W
	36 x 72	Static	44RT3672D20	\$2,134	\$2,403	\$2,429
	36 x 84	Static	44RT3684D20	2,453	2,816	2,802
	36 x 90	Static	44RT3690D20	2,586	3,000	2,961
	36 x 96 *	Static	44RT3696D20	2,586	3,000	2,976
	42 x 84	Static	44RT4284D24	2,557	2,921	2,914
	42 x 90	Static	44RT4290D24	2,690	3,105	3,075
	42 x 96 *	Static	44RT4296D24	2,690	3,105	3,090
	48 x 84	Static	44RT4884D32	3,167	3,641	3,561
	48 x 90	Static	44RT4890D32	3,167	3,641	3,576
	48 x 96 *	Static	44RT4896D32	3,167	3,641	3,590

⊗ → **CH** **SH**
2 disc bases: +840 +136

Racetrack with 2 Drum Bases	Top Size	Base	Model Number	3P	3K	3W
	36 x 72	Drum	44RT3672DR18	\$4,956	\$5,224	\$5,252
	36 x 84	Drum	44RT3684DR18	5,191	5,554	5,539
	36 x 90	Drum	44RT3690DR18	5,407	5,823	5,784
	36 x 96 *	Drum	44RT3696DR18	5,407	5,823	5,799
	42 x 84	Drum	44RT4284DR18	5,191	5,554	5,549
	42 x 90	Drum	44RT4290DR18	5,407	5,823	5,792
	42 x 96 *	Drum	44RT4296DR18	5,407	5,823	5,807
	48 x 84	Drum	44RT4884DR24	5,731	6,205	6,125
	48 x 90	Drum	44RT4890DR24	5,815	6,289	6,224
	48 x 96 *	Drum	44RT4896DR24	5,815	6,289	6,239

⊗ → **CH** **SH**
Drum bases: N/A N/A

Racetrack with 3 Disc Bases	Top Size	Base	Model Number	3P	3K	3W
	42 x 120	Static	44RT42120D24(3)	\$4,047	\$4,706	\$4,567
	42 x 144	Static	44RT42144D24(3)	4,338	5,112	4,946
	48 x 120	Static	44RT48120D32(3)	4,563	5,227	5,093
	48 x 144	Static	44RT48144D32(3)	4,857	5,638	5,475

CH **SH** ← ⊗
+1,260 +204 3 disc bases:

* \$200 NET surcharge per order for oversized pallet

For Primary series table options, please reference pages 130-131.

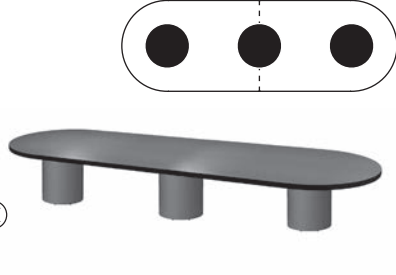
Top Size	Base	Model Number	3P	3K	3W	Racetrack with 3 Drum Bases
42 x 120	Drum	44RT42120DR18(3)	\$ 8,124	\$ 8,782	\$ 8,644	
42 x 144	Drum	44RT42144DR18(3)	8,414	9,189	9,023	
48 x 120	Drum	44RT48120DR24(3)	8,535	9,200	9,065	
48 x 144	Drum	44RT48144DR24(3)	8,829	9,610	9,447	

CH SH ⊗
 N/A N/A Drum bases:

Top Size	Base	Model Number	3P	3K	3W	Elliptical with 2 Disc Bases
36 x 72	Static	44EL3672D20	\$ 2,134	\$ 2,403	\$ 2,410	
36 x 84	Static	44EL3684D20	2,330	2,644	2,642	
36 x 90	Static	44EL3690D20	2,439	2,796	2,772	
36 x 96 *	Static	44EL3696D20	2,439	2,796	2,784	
42 x 72	Static	44EL4272D24	2,351	2,664	2,651	
42 x 84	Static	44EL4284D24	2,557	2,921	2,892	
42 x 90	Static	44EL4290D24	2,692	3,108	3,052	
42 x 96 *	Static	44EL4296D24	2,692	3,108	3,063	
48 x 84	Static	44EL4884D32	3,168	3,642	3,542	
48 x 90	Static	44EL4890D32	3,168	3,642	3,555	
48 x 96 *	Static	44EL4896D32	3,168	3,642	3,566	

⊗ → CH SH
 2 disc bases: +840 +136

Top Size	Base	Model Number	3P	3K	3W	Elliptical with 2 Drum Bases
36 x 72	Drum	44EL3672DR18	\$ 4,956	\$ 5,224	\$ 5,233	
36 x 84	Drum	44EL3684DR18	5,069	5,383	5,380	
36 x 90	Drum	44EL3690DR18	5,261	5,618	5,594	
36 x 96 *	Drum	44EL3696DR18	5,261	5,618	5,605	
42 x 72	Drum	44EL4272DR18	5,069	5,383	5,368	
42 x 84	Drum	44EL4284DR18	5,191	5,554	5,526	
42 x 90	Drum	44EL4290DR18	5,409	5,826	5,769	
42 x 96 *	Drum	44EL4296DR18	5,409	5,826	5,781	
48 x 84	Drum	44EL4884DR24	5,732	6,206	6,106	
48 x 90	Drum	44EL4890DR24	5,816	6,290	6,202	
48 x 96 *	Drum	44EL4896DR24	5,816	6,290	6,213	

⊗ → CH SH
 Drum bases: N/A N/A

* \$200 NET surcharge per order for oversized pallet

For Primary series table options, please reference pages 130-131.

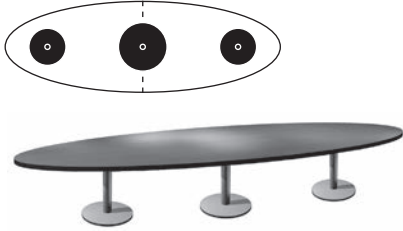
Elliptical with 3 Disc Bases	Top Size	Base	Model Number	3P	3K	3W
	42 x 120	Static	44EL42120D202420	\$ 3,943	\$ 4,601	\$ 4,422
	42 x 144	Static	44EL42144D202420	4,234	5,008	4,787
	48 x 120	Static	44EL48120D243224	4,231	4,895	4,722
	48 x 144	Static	44EL48144D243224	4,524	5,306	5,092

CH SH
+1,260 +204
3 disc bases:

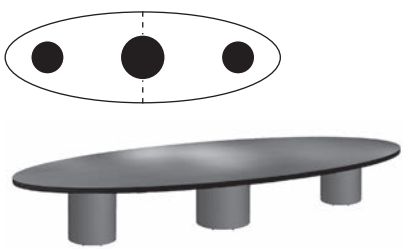
Elliptical with 3 Drum Bases	Top Size	Base	Model Number	3P	3K	3W
	42 x 120	Drum	44EL42120DR182418	\$ 8,256	\$ 8,913	\$ 8,733
	42 x 144	Drum	44EL42144DR182418	8,546	9,320	9,100
	48 x 120	Drum	44EL48120DR182418	8,272	8,936	8,764
	48 x 144	Drum	44EL48144DR182418	8,565	9,348	9,133

CH SH
N/A N/A
Drum bases:

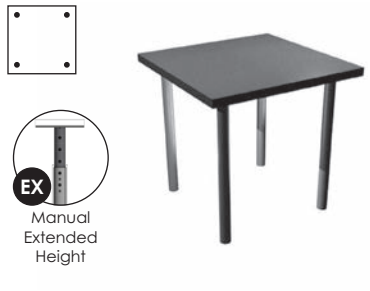
Square with Column Bases	Top Size	Base	Model Number	3P	3K	3W
 <p>EX Manual Extended Height</p>	24 x 24	Static	44SQ2424C2	\$ 602	\$ 648	\$ 732
	30 x 30	Static	44SQ3030C2	663	733	829
	36 x 36	Static	44SQ3636C2	738	837	940
	42 x 42	Static	44SQ4242C2	825	960	1,066
	48 x 48	Static	44SQ4848C2	926	1,101	1,206
	54 x 54	Static	44SQ5454C2	1,039	1,259	1,360
	60 x 60	Static	44SQ6060C2	1,250	1,521	1,613

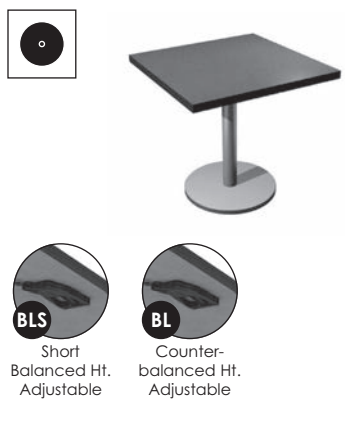
Square with Disc Base	Top Size	Base	Model Number	3P	3K	3W
 <p>BLS Short Balanced Ht. Adjustable</p> <p>BL Counter-balanced Ht. Adjustable</p>	24 x 24	Static	44SQ2424D20	\$ 877	\$ 922	\$ 1,006
		Short Bal	44SQ2424D20BLS	1,464	1,510	1,594
	30 x 30	Static	44SQ3030D24	991	1,061	1,155
		Short Bal	44SQ3030D24BLS	1,869	1,940	2,035
	36 x 36	Static	44SQ3636D24	1,064	1,164	1,267
		Short Bal	44SQ3636D24BLS	1,943	2,044	2,146
		Count Bal	44SQ3636D24BL	1,943	2,044	2,146
	42 x 42	Static	44SQ4242D32	1,318	1,453	1,560
		Short Bal	44SQ4242D32BLS	2,190	2,324	2,430
		Count Bal	44SQ4242D32BL	2,190	2,324	2,430

Disc bases:
CH SH
+420 +68

For Primary series table options, please reference pages 130-131.

Top Size	Base	Model Number	3P	3K	3W	Square with Drum Base
30 x 30	Drum	44SQ3030DR18	\$2,349	\$2,420	\$2,515	
36 x 36	Drum	44SQ3636DR18	2,423	2,524	2,625	
42 x 42	Drum	44SQ4242DR24	2,642	2,777	2,883	
48 x 48	Drum	44SQ4848DR24	2,742	2,917	3,023	
54 x 54	Drum	44SQ5454DR28	3,293	3,514	3,615	
60 x 60	Drum	44SQ6060DR28	3,419	3,690	3,784	

Drum bases: CH N/A SH N/A

primary

Top Size	Base	Model Number	3P	3K	3W	Round with Column Bases
24 x 24	Static	44RD24C2	\$ 640	\$ 701	\$ 748	
30 x 30	Static	44RD30C2	723	817	863	
36 x 36	Static	44RD36C2	811	940	983	
42 x 42	Static	44RD42C2	928	1,103	1,133	
48 x 48	Static	44RD48C2	960	1,148	1,193	
54 x 54	Static	44RD54C2	1,149	1,414	1,425	
60 x 60	Static	44RD60C2	1,176	1,452	1,478	

EX Manual Extended Height

Top Size	Base	Model Number	3P	3K	3W	Round with Disc Base
24 x 24	Static	44RD24D20	\$ 915	\$ 975	\$ 1,023	
	Short Bal	44RD24D20BLS	1,502	1,563	1,610	
30 x 30	Static	44RD30D20	998	1,091	1,138	
	Short Bal	44RD30D20BLS	1,585	1,679	1,726	
36 x 36	Static	44RD36D20	1,085	1,214	1,257	
	Short Bal	44RD36D20BLS	1,673	1,802	1,845	
	Count Bal	44RD36D20BL	1,673	1,802	1,845	
42 x 42	Static	44RD42D24	1,254	1,430	1,461	
	Short Bal	44RD42D24BLS	2,133	2,308	2,340	
	Count Bal	44RD42D24BL	2,133	2,308	2,340	
48 x 48	Static	44RD48D32	1,453	1,642	1,686	
	Short Bal	44RD48D32BLS	2,324	2,512	2,557	
	Count Bal	44RD48D32BL	2,324	2,512	2,557	

BLS Short Balanced Ht. Adjustable
BL Counter-balanced Ht. Adjustable

CH +420 SH +68 Disc bases:

Top Size	Base	Model Number	3P	3K	3W	Round with Drum Base
30 x 30	Drum	44RD30DR18	\$2,409	\$2,503	\$2,549	
36 x 36	Drum	44RD36DR18	2,496	2,625	2,669	
42 x 42	Drum	44RD42DR24	2,744	2,919	2,951	
48 x 48	Drum	44RD48DR24	2,777	2,966	3,010	
54 x 54	Drum	44RD54DR24	2,967	3,231	3,242	
60 x 60	Drum	44RD60DR28	3,430	3,705	3,731	

CH N/A SH N/A Drum bases:

For Primary series table options, please reference pages 130-131.

D-shaped with Column Bases	Top Size	Base	Model Number	3P	3K	3W
	24 x 36	Static	44D2436C2	\$ 711	\$ 801	\$ 869
	24 x 48	Static	44D2448C2	786	905	980
	24 x 60	Static	44D2460C2	860	1,008	1,091
	24 x 72	Static	44D2472C2	1,019	1,197	1,288
	24 x 84	Static	44D2484C2	1,094	1,301	1,399
	24 x 90	Static	44D2490C2	1,130	1,354	1,455
	24 x 96 *	Static	44D2496C2	1,167	1,405	1,510
	30 x 48	Static	44D3048C2	860	1,008	1,074
	30 x 60	Static	44D3060C2	953	1,140	1,206
	30 x 72	Static	44D3072C2	1,130	1,354	1,422
	30 x 84	Static	44D3084C2	1,224	1,484	1,554
	30 x 90	Static	44D3090C2	1,270	1,549	1,620
	30 x 96 *	Static	44D3096C2	1,316	1,614	1,686
	36 x 48	Static	44D3648C2	935	1,113	1,167
	36 x 60	Static	44D3660C2	1,046	1,269	1,319
	36 x 72	Static	44D3672C2	1,242	1,509	1,557
	36 x 84	Static	44D3684C2	1,354	1,666	1,709
	36 x 90	Static	44D3690C2	1,410	1,745	1,785
36 x 96 *	Static	44D3696C2	1,465	1,822	1,861	



D-shaped with 2 Drum Bases	Top Size	Base	Model Number	3P	3K	3W
	30 x 60	Drum	44D3060DR18	\$4,750	\$4,935	\$5,003
	30 x 72	Drum	44D3072DR18	4,843	5,066	5,134
	30 x 84	Drum	44D3084DR18	5,021	5,281	5,350
	30 x 90	Drum	44D3090DR18	5,067	5,345	5,416
	30 x 96 *	Drum	44D3096DR18	5,113	5,410	5,483
	36 x 72	Drum	44D3672DR18	4,954	5,222	5,268
	36 x 84	Drum	44D3684DR18	5,150	5,463	5,506
	36 x 90	Drum	44D3690DR18	5,206	5,541	5,581
	36 x 96 *	Drum	44D3696DR18	5,262	5,619	5,658
	42 x 72	Drum	44D4272DR24	5,548	5,948	5,907
	42 x 84	Drum	44D4284DR24	5,663	6,076	6,055
	42 x 90	Drum	44D4290DR24	5,737	6,179	6,150
	42 x 96 *	Drum	44D4296DR24	5,810	6,282	6,247
	48 x 72	Drum	44D4872DR24	5,590	6,006	5,964
	48 x 84	Drum	44D4884DR24	5,674	6,090	6,078
	48 x 90	Drum	44D4890DR24	5,748	6,194	6,174
	48 x 96 *	Drum	44D4896DR24	5,823	6,298	6,271



* \$200 NET surcharge per order for oversized pallet

For Primary series table options, please reference pages 130-131.

Top Size	Base	Model Number	3P	3K	3W	D-shaped with 2 Disc Bases
24 x 60	Static	44D2460D20	\$ 1,835	\$ 1,984	\$ 2,067	
24 x 72	Static	44D2472D20	1,909	2,088	2,178	
24 x 84	Static	44D2484D20	2,068	2,276	2,373	
24 x 90	Static	44D2490D20	2,105	2,328	2,429	
24 x 96 *	Static	44D2496D20	2,142	2,380	2,485	
30 x 60	Static	44D3060D20	1,927	2,114	2,180	
30 x 72	Static	44D3072D20	2,021	2,244	2,313	
30 x 84	Static	44D3084D20	2,198	2,459	2,529	
30 x 90	Static	44D3090D20	2,244	2,524	2,594	
30 x 96 *	Static	44D3096D20	2,291	2,589	2,660	
36 x 72	Static	44D3672D24	2,237	2,505	2,551	
36 x 84	Static	44D3684D24	2,432	2,745	2,788	
36 x 90	Static	44D3690D24	2,489	2,823	2,864	
36 x 96 *	Static	44D3696D24	2,545	2,902	2,940	
42 x 72	Static	44D4272D32	2,900	3,300	3,259	
42 x 84	Static	44D4284D32	3,015	3,428	3,407	
42 x 90	Static	44D4290D32	3,089	3,531	3,503	
42 x 96 *	Static	44D4296D32	3,163	3,635	3,599	

primary

* \$200 NET surcharge per order for oversized pallet

For Primary series table options, please reference pages 130-131.

Half Round with Column Bases	Top Size	Base	Model Number	3P	3K	3W
	18 x 36	Static	44HR1836C2(3)	\$ 615	\$ 708	\$ 752
	24 x 48	Static	44HR2448C2(3)	683	804	866
	30 x 60	Static	44HR3060C2	955	1,142	1,192
	36 x 72	Static	44HR3672C2	1,241	1,508	1,536



Trapezoid with Column Bases	Top Size	Base	Model Number	3P	3K	3W
	24 x 48	Static	44TZ2448C2	\$ 566	\$ 683	\$ 748
	24 x 72	Static	44TZ2472C2	755	948	1,032
	30 x 60	Static	44TZ3060C2	692	859	924
	36 x 72	Static	44TZ3672C2	917	1,174	1,210



Squircle with Column Bases	Top Size	Base	Model Number	3P	3K	3W
	24 x 24	Static	44SL24C2	\$ 813	\$ 942	\$ 963
	30 x 30	Static	44SL30C2	869	1,021	1,055
	36 x 36	Static	44SL36C2	932	1,108	1,153
	42 x 42	Static	44SL42C2	1,000	1,205	1,258
	48 x 48	Static	44SL48C2	1,082	1,319	1,378



For Primary series table options, please reference pages 130-131.

For Primary series table options, please reference pages 130-131.

tablex

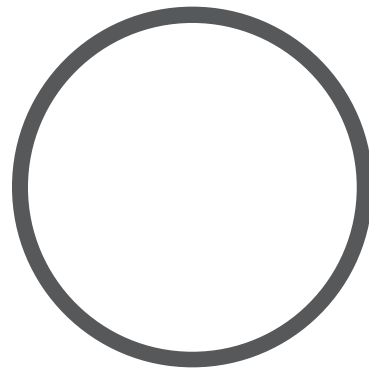

45 puddle
price list
Effective May 16, 2022

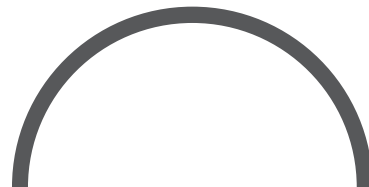



A base that seems to melt into the floor. Puddle is a clean and simple solution. Available on square, round, rectangle, and racetrack tables.

Puddle Base



D

Puddle Options

- LC** **Locking Casters**
are not available on Puddle tables.
- FD** **Folding Bases**
are not available on Puddle tables.
- NE** **Nesting Tables**
are not available on Puddle tables.
- FT** **Flip Tops**
are not available on Puddle tables.
- CH** **Chrome Finish**
available for \$439 per base. Brushed Steel is not available on Puddle tables.
- WM** **Wire Management**
Built-in wire management is available on one leg for \$132 per column.
- WMLC** **Wire Management Leg Covers 3"**
snap onto any leg and are \$75 each.
- SH** **Special Height**
can be added to any table:
+ \$68 per column for heights > 29"
+ \$37 per column for heights < 29"
Special height tables with tops larger than 36x72" must be custom quoted.
- FR** **Footring**
is available on Puddle tables for \$158.
- PB** **Powerbox Mounting Plate**
is available on disc bases for \$95.

Puddle Height Adjustable Options

- AH Spring Clip**
is available on disc bases for \$131 per base. Not available in chrome. For height option details, see page 19.
- BL Counterbalanced and Short Balanced**
are available on single disc bases. Available height adjustable finishes can be found on page 9.
- NU Pneumatic**
is available on X-bases for \$368 and on T-bases for \$735 per table. For height option details, see page 19.

Puddle Top Shapes



Square
p.148



Rectangle
p.148



Round
p.149



Squircle
p.149





Racetrack
p.149

Puddle Top Options

- RC 3" Radius Corners**
can be added to any table for \$58.
- LT Lightweight Tops**
can be added to any square or rectangular table for \$121.
- GR Grommets**
can be added to any table for \$42 each. To see specific locations, see page 217.
- GN Ganging Plates & Knobs**
can be added to most table shapes for \$42 (includes 2 plates and 8 knobs per table).
- QC Quick-Connect Ganging Brackets**
can be added to most table shapes for \$42 (includes 4 connectors per table).

Puddle Edge Options

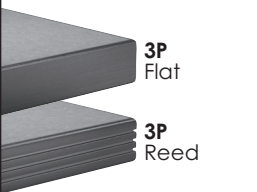
(corresponds with 3 columns of pricing)

3mm PVC	3mm PVC	3mm Wood
 <p>3P Flat</p> <p>3P Reed</p>	 <p>3K Knife</p>	 <p>3W Flat</p>

Square with Disc Base		Top Size	Base	Model Number	3P	3K	3W
	24 x 24	Static		45SQ2424D22	\$ 760	\$ 805	\$ 889
		Short Bal		45SQ2424D22BLS	1,666	1,711	1,795
	30 x 30	Static		45SQ3030D22	821	891	986
		Short Bal		45SQ3030D22BLS	1,727	1,797	1,893
		Count Bal		45SQ3030D22BL	1,727	1,797	1,893
	36 x 36	Static		45SQ3636D26	942	1,042	1,145
Short Bal			45SQ3636D26BLS	2,223	2,324	2,426	
Count Bal			45SQ3636D26BL	2,223	2,324	2,426	

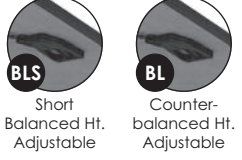

Rectangular with Disc Bases		Top Size	Base	Model Number	3P	3K	3W
	24 x 60	Static		45TC2460D22	\$ 1,477	\$ 1,575	\$ 1,709
	24 x 72	Static		45TC2472D22	1,524	1,642	1,790
	24 x 84	Static		45TC2484D22	1,699	1,854	2,005
	24 x 90	Static		45TC2490D22	1,754	1,930	2,079
	24 x 96 *	Static		45TC2496D22	1,754	1,930	2,094
	30 x 60	Static		45TC3060D22	1,525	1,645	1,777
	30 x 72	Static		45TC3072D22	1,579	1,719	1,865
	30 x 84	Static		45TC3084D22	1,792	1,984	2,121
	30 x 90	Static		45TC3090D22	1,860	2,078	2,211
	30 x 96 *	Static		45TC3096D22	1,860	2,078	2,225
	36 x 72	Static		45TC3672D26	1,785	1,970	2,098
	36 x 84	Static		45TC3684D26	1,981	2,210	2,334
	36 x 90	Static		45TC3690D26	2,061	2,321	2,436
	36 x 96 *	Static		45TC3696D26	2,061	2,321	2,451
	42 x 72	Static		45TC4272D26	1,901	2,132	2,240
	42 x 84	Static		45TC4284D26	2,077	2,345	2,455
	42 x 90	Static		45TC4290D26	2,167	2,471	2,569
	42 x 96 *	Static		45TC4296D26	2,167	2,471	2,583











Rectangular with 3 Disc Bases		Top Size	Base	Model Number	3P	3K	3W
	42 x 120	Static		45TC42120D26(3)	\$ 3,166	\$ 3,617	\$ 3,679
	42 x 144	Static		45TC42144D26(3)	3,351	3,876	3,941



* \$200 NET surcharge per order for oversized pallet

For Puddle series table options, please reference pages 146-147.

Top Size	Base	Model Number	3P	3K	3W	Round with Disc Base
24 x 24	Static	45RD24D22	\$ 797	\$ 857	\$ 906	    <p>Short Balanced Ht. Adjustable</p> <p>Counter- balanced Ht. Adjustable</p>
	Short Bal	45RD24D22BLS	1,704	1,764	1,812	
30 x 30	Static	45RD30D22	880	974	1,020	
	Short Bal	45RD30D22BLS	1,787	1,880	1,926	
36 x 36	Static	45RD36D22	968	1,097	1,140	
	Short Bal	45RD36D22BLS	1,874	2,004	2,046	
	Count Bal	45RD36D22BL	1,874	2,004	2,046	
42 x 42	Static	45RD42D26	1,132	1,308	1,339	
	Short Bal	45RD42D26BLS	2,413	2,589	2,620	
	Count Bal	45RD42D26BL	2,413	2,589	2,620	

Top Size	Base	Model Number	3P	3K	3W	Squircle with Disc Base
24 x 24	Static	45SL24D22	\$ 970	\$ 1,100	\$ 1,121	    <p>Short Balanced Ht. Adjustable</p> <p>Counter- balanced Ht. Adjustable</p>
	Short Bal	45SL24D22BLS	1,876	2,006	2,027	
30 x 30	Static	45SL30D22	1,026	1,179	1,212	
	Short Bal	45SL30D22BLS	1,932	2,085	2,118	
	Count Bal	45SL30D22BL	1,932	2,085	2,118	
36 x 36	Static	45SL36D26	1,137	1,314	1,358	
	Short Bal	45SL36D26BLS	2,418	2,595	2,639	
	Count Bal	45SL36D26BL	2,418	2,595	2,639	

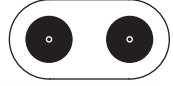
Top Size	Base	Model Number	3P	3K	3W	Racetrack with Disc Base
36 x 72	Static	45RT3672D26	\$ 1,994	\$ 2,263	\$ 2,291	 
36 x 84	Static	45RT3684D26	2,314	2,677	2,662	
36 x 90	Static	45RT3690D26	2,446	2,862	2,823	
36 x 96 *	Static	45RT3696D26	2,446	2,862	2,838	
42 x 84	Static	45RT4284D26	2,314	2,677	2,671	
42 x 90	Static	45RT4290D26	2,446	2,862	2,831	
42 x 96 *	Static	45RT4296D26	2,446	2,862	2,846	

CH ← ⊗
+526 2 disc bases:

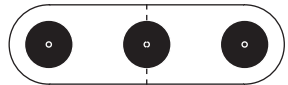
Top Size	Base	Model Number	3P	3K	3W	Racetrack with 3 Disc Base
42 x 120	Static	45RT42120D26(3)	\$ 3,682	\$ 4,340	\$ 4,202	 
42 x 144	Static	45RT42145D26(3)	3,973	4,746	4,581	

CH ← ⊗
+789 3 disc bases:

* \$200 NET surcharge per order for oversized pallet

For Puddle series table options, please reference pages 146-147.

puddle

tablex

71 exclaim
price list
Effective May 16, 2022





Exclaim is both simple, yet sophisticated. These angled square columns build a collection of attractive tables with a variety of base configurations.

Exclaim Base Configurations

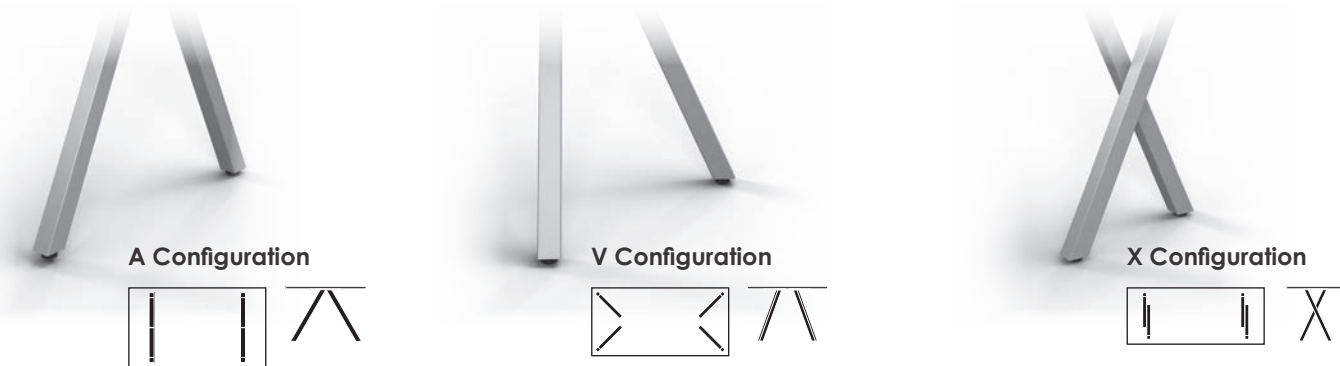

Exclaim Options

Angled 2" Column with Standard Glides

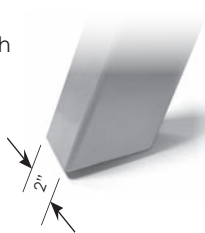

Angled 3" Column with Standard Glides

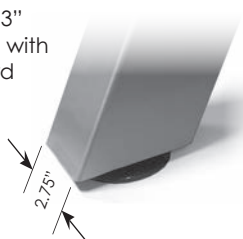

LC **Locking Casters** are not available on Exclaim tables.

FD **Folding Bases** are not available on Exclaim tables.

NE **Nesting Tables** are not available on Exclaim tables.

FT **Flip Tops** are not available on Exclaim tables.

PB **Powerbox Mounting Plate** is not available on Exclaim tables.

CH **Chrome Finish** ONLY available on Exclaim 3" angled columns at Standard or Lounge heights for \$110 per column. (Not available on 2" columns)

WMH **Wire Management Holes** Two built-in wire management mouse holes available for \$32 per leg on the 3" columns only. Not available on chrome.

MMLC **Magnetic Wire Management Leg Covers** Magnetically attaches onto any square leg and are \$67 each.

SH **Special Heights** of 42" are available on all standard Exclaim tables for \$53 per column. Special height of 18" is available on select Exclaim models shown on pages 154-155.

Other custom heights are not available on Exclaim.

Exclaim Top Shapes

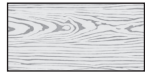

Rectangle
p.156



Boat
p.158



Racetrack
p.159

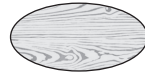

Elliptical
p.160



D-shaped
p.162



Square
p.163



Round
p.163

Exclaim Lounge Height Top Shapes



Square
p.154



Round
p.154



Rectangle
p.155

exclaim

Exclaim Top Options

- RC 3" Radius Corners** can be added to any table for \$58.
- GN Ganging Plates & Knobs** can be added to most table shapes for \$42 (includes 2 plates and 8 knobs per table).
- LT Lightweight Tops** can be added to any square or rectangular table for \$121.
- GR Grommets** can be added to any table for \$42 each. To see specific locations, see page 217.
- QG Quick-Connect Ganging Brackets** can be added to any table for \$42 (includes 4 connectors per table).

Exclaim Edge Options

(corresponds with 3 columns of pricing)

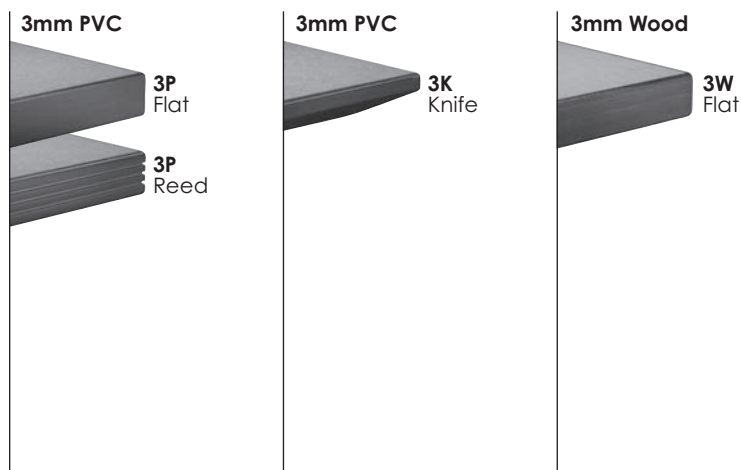

3 Heights Available

Lounge Height of 18" is available on square, round, and rectangular tables. These models are designated with a "-SH.18" in the model number and are listed on the next two pages.

Standard Height of 29" is shown on all standard models in the Exclaim line listed on pages 156-163. Custom heights outside of the three shown here are not available.

Standing Height of 42" is available on any standard Exclaim table. Simply add "-SH.42" to the model number and add \$53 per column to the list prices on pages 156-163.



SH.18 18" Lounge Height

18"H Square with 4 Columns	Top Size	Base	Model Number	3P	3K	3W
	24 x 24	Angled 2"	71SQ2424Q2-SH.18	\$ 887	\$ 932	\$ 1,016
	30 x 30	Angled 2"	71SQ3030Q2-SH.18	948	1,018	1,113
	36 x 36	Angled 2"	71SQ3636Q2-SH.18	1,022	1,122	1,225
	42 x 42	Angled 2"	71SQ4242Q2-SH.18	1,109	1,244	1,350
	48 x 48	Angled 2"	71SQ4848Q2-SH.18	1,210	1,384	1,490

18"H Round with 3 Columns	Top Size	Base	Model Number	3P	3K	3W
	24 x 24	Angled 2"	71RD24Q2(3)-SH.18	\$ 747	\$ 808	\$ 855

18"H Round with 4 Columns	Top Size	Base	Model Number	3P	3K	3W
	30 x 30	Angled 2"	71RD30Q2-SH.18	\$ 1,007	\$ 1,101	\$ 1,147
	36 x 36	Angled 2"	71RD36Q2-SH.18	1,095	1,224	1,267
	42 x 42	Angled 2"	71RD42Q2-SH.18	1,211	1,386	1,418
	48 x 48	Angled 2"	71RD48Q2-SH.18	1,244	1,433	1,477
	54 x 54	Angled 2"	71RD54Q2-SH.18	1,434	1,698	1,709
	60 x 60	Angled 2"	71RD60Q2-SH.18	1,460	1,735	1,761



For Exclaim table options, please reference pages 152-153.



SH.18 18" Lounge Height

Top Size	Base	Model Number	3P	3K	3W	18"H Rectangular with A Configuration
20 x 36	Angled 2"	71TC2036Q2.A-SH.18	\$ 941	\$1,008	\$1,096	
20 x 48	Angled 2"	71TC2048Q2.A-SH.18	996	1,085	1,186	
20 x 60	Angled 2"	71TC2060Q2.A-SH.18	1,021	1,121	1,244	
20 x 72	Angled 2"	71TC2072Q2.A-SH.18	1,068	1,187	1,325	
24 x 36	Angled 2"	71TC2436Q2.A-SH.18	941	1,008	1,106	
24 x 48	Angled 2"	71TC2448Q2.A-SH.18	996	1,085	1,195	
24 x 60	Angled 2"	71TC2460Q2.A-SH.18	1,021	1,121	1,253	
24 x 72	Angled 2"	71TC2472Q2.A-SH.18	1,068	1,187	1,335	
30 x 36	Angled 2"	71TC3036Q2.A-SH.18	981	1,065	1,165	
30 x 48	Angled 2"	71TC3048Q2.A-SH.18	1,049	1,160	1,269	
30 x 60	Angled 2"	71TC3060Q2.A-SH.18	1,070	1,189	1,322	
30 x 72	Angled 2"	71TC3072Q2.A-SH.18	1,123	1,264	1,410	
36 x 48	Angled 2"	71TC3648Q2.A-SH.18	1,103	1,235	1,343	
36 x 60	Angled 2"	71TC3660Q2.A-SH.18	1,184	1,348	1,461	
36 x 72	Angled 2"	71TC3672Q2.A-SH.18	1,234	1,419	1,547	

Top Size	Base	Model Number	3P	3K	3W	18"H Rectangular with V Configuration
24 x 36	Angled 2"	71TC2436Q2.V-SH.18	\$ 941	\$1,008	\$1,106	
24 x 48	Angled 2"	71TC2448Q2.V-SH.18	996	1,085	1,195	
24 x 60	Angled 2"	71TC2460Q2.V-SH.18	1,021	1,121	1,253	
24 x 72	Angled 2"	71TC2472Q2.V-SH.18	1,068	1,187	1,335	
30 x 36	Angled 2"	71TC3036Q2.V-SH.18	981	1,065	1,165	
30 x 48	Angled 2"	71TC3048Q2.V-SH.18	1,049	1,160	1,269	
30 x 60	Angled 2"	71TC3060Q2.V-SH.18	1,070	1,189	1,322	
30 x 72	Angled 2"	71TC3072Q2.V-SH.18	1,123	1,264	1,410	
36 x 48	Angled 2"	71TC3648Q2.V-SH.18	1,103	1,235	1,343	
36 x 60	Angled 2"	71TC3660Q2.V-SH.18	1,184	1,348	1,461	
36 x 72	Angled 2"	71TC3672Q2.V-SH.18	1,234	1,419	1,547	



For Exclaim table options, please reference pages 152-153.



Rectangular with X Configuration	Top Size	Base	Model Number	3P	3K	3W
 	20 x 36	Angled 2"	71TC2036Q2.X	\$ 941	\$ 1,008	\$ 1,096
	20 x 48	Angled 2"	71TC2048Q2.X	996	1,085	1,186
	20 x 60	Angled 2"	71TC2060Q2.X	1,021	1,121	1,244
	20 x 72	Angled 2"	71TC2072Q2.X	1,152	1,271	1,410
	20 x 84	Angled 2"	71TC2084Q2.X	1,244	1,399	1,540
	20 x 90	Angled 2"	71TC2090Q2.X	1,298	1,476	1,614
	20 x 96 *	Angled 2"	71TC2096Q2.X	1,298	1,476	1,629
	24 x 36	Angled 2"	71TC2436Q2.X	941	1,008	1,106
	24 x 48	Angled 2"	71TC2448Q2.X	996	1,085	1,195
	24 x 60	Angled 2"	71TC2460Q2.X	1,021	1,121	1,253
	24 x 72	Angled 2"	71TC2472Q2.X	1,152	1,271	1,419
	24 x 84	Angled 2"	71TC2484Q2.X	1,244	1,399	1,549
	24 x 90	Angled 2"	71TC2490Q2.X	1,298	1,476	1,624
	24 x 96 *	Angled 2"	71TC2496Q2.X	1,298	1,476	1,638
	30 x 36	Angled 2"	71TC3036Q2.X	981	1,065	1,165
	30 x 48	Angled 2"	71TC3048Q2.X	1,049	1,160	1,269
	30 x 60	Angled 2"	71TC3060Q2.X	1,070	1,189	1,322
	30 x 72	Angled 2"	71TC3072Q2.X	1,123	1,264	1,410
30 x 84	Angled 2"	71TC3084Q2.X	1,336	1,528	1,666	
30 x 90	Angled 2"	71TC3090Q2.X	1,404	1,624	1,755	
30 x 96 *	Angled 2"	71TC3096Q2.X	1,404	1,624	1,770	



Rectangular with V Configuration	Top Size	Base	Model Number	3P	3K	3W
 	36 x 48	Angled 2"	71TC3648Q2.V	\$ 1,103	\$ 1,235	\$ 1,343
	36 x 60	Angled 2"	71TC3660Q2.V	1,184	1,348	1,461
	36 x 72	Angled 2"	71TC3672Q2.V	1,234	1,419	1,547
	36 x 84	Angled 2"	71TC3684Q2.V	1,430	1,658	1,782
	36 x 90	Angled 2"	71TC3690Q2.V	1,509	1,770	1,885
	36 x 96 *	Angled 2"	71TC3696Q2.V	1,509	1,770	1,900
	42 x 60	Angled 3"	71TC4260Q3.V	1,279	1,472	1,579
	42 x 72	Angled 3"	71TC4272Q3.V	1,375	1,606	1,714
	42 x 84	Angled 3"	71TC4284Q3.V	1,551	1,820	1,929
	42 x 90	Angled 3"	71TC4290Q3.V	1,642	1,945	2,043
	42 x 96 *	Angled 3"	71TC4296Q3.V	1,642	1,945	2,057
	48 x 60	Angled 3"	71TC4860Q3.V	1,305	1,508	1,623
	48 x 72	Angled 3"	71TC4872Q3.V	1,458	1,722	1,820
	48 x 84	Angled 3"	71TC4884Q3.V	1,551	1,820	1,944
	48 x 90	Angled 3"	71TC4890Q3.V	1,643	1,947	2,060
	48 x 96 *	Angled 3"	71TC4896Q3.V	1,643	1,947	2,074

* \$200 NET surcharge per order for oversized pallet

For Exclaim table options, please reference pages 152-153.



Top Size	Base	Model Number	3P	3K	3W	Rectangular with V6 Configuration
42 x 120	Angled 3"	71TC42120Q3.V6	\$2,462	\$2,912	\$2,974	 
42 x 144	Angled 3"	71TC42144Q3.V6	2,646	3,171	3,237	
48 x 120	Angled 3"	71TC48120Q3.V6	2,472	2,928	3,001	
48 x 144	Angled 3"	71TC48144Q3.V6	2,659	3,189	3,266	



Top Size	Base	Model Number	3P	3K	3W	Rectangular with A Configuration
42 x 60	Angled 3"	71TC4260Q3.A	\$1,279	\$1,472	\$1,579	 
42 x 72	Angled 3"	71TC4272Q3.A	1,375	1,606	1,714	
42 x 84	Angled 3"	71TC4284Q3.A	1,551	1,820	1,929	
42 x 90	Angled 3"	71TC4290Q3.A	1,642	1,945	2,043	
42 x 96 *	Angled 3"	71TC4296Q3.A	1,642	1,945	2,057	
48 x 60	Angled 3"	71TC4860Q3.A	1,305	1,508	1,623	
48 x 72	Angled 3"	71TC4872Q3.A	1,458	1,722	1,820	
48 x 84	Angled 3"	71TC4884Q3.A	1,551	1,820	1,944	
48 x 90	Angled 3"	71TC4890Q3.A	1,643	1,947	2,060	
48 x 96 *	Angled 3"	71TC4896Q3.A	1,643	1,947	2,074	

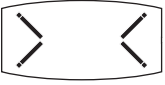

Top Size	Base	Model Number	3P	3K	3W	Rectangular with A6 Configuration
42 x 120	Angled 3"	71TC42120Q3.A6	\$2,462	\$2,912	\$2,974	 
42 x 144	Angled 3"	71TC42144Q3.A6	2,646	3,171	3,237	
48 x 120	Angled 3"	71TC48120Q3.A6	2,472	2,928	3,001	
48 x 144	Angled 3"	71TC48144Q3.A6	2,659	3,189	3,266	



* \$200 NET surcharge per order for oversized pallet

For Exclaim table options, please reference pages 152-153.

Boat-shaped with V Configuration	Top Size	Base	Model Number	3P	3K	3W
 	30 x 42 x 84	Angled 3"	71BT3084Q3.V	\$ 1,791	\$ 2,155	\$ 2,149
	30 x 42 x 90	Angled 3"	71BT3090Q3.V	1,920	2,336	2,305
	30 x 42 x 96 *	Angled 3"	71BT3096Q3.V	1,920	2,336	2,320
	36 x 48 x 84	Angled 3"	71BT3684Q3.V	1,919	2,334	2,298
	36 x 48 x 90	Angled 3"	71BT3690Q3.V	2,066	2,539	2,473
	36 x 48 x 96 *	Angled 3"	71BT3696Q3.V	2,066	2,539	2,489

Boat-shaped with V6 Configuration	Top Size	Base	Model Number	3P	3K	3W
 	36 x 48 x 120	Angled 3"	71BT36120Q3.V6	\$ 2,994	\$ 3,658	\$ 3,523
	36 x 48 x 144	Angled 3"	71BT36144Q3.V6	3,287	4,068	3,905

Boat-shaped with A Configuration	Top Size	Base	Model Number	3P	3K	3W
 	36 x 48 x 84	Angled 3"	71BT3684Q3.A	\$ 1,919	\$ 2,334	\$ 2,298
	36 x 48 x 90	Angled 3"	71BT3690Q3.A	2,066	2,539	2,473
	36 x 48 x 96 *	Angled 3"	71BT3696Q3.A	2,066	2,539	2,489

Boat-shaped with A6 Configuration	Top Size	Base	Model Number	3P	3K	3W
 	36 x 48 x 120	Angled 3"	71BT36120Q3.A6	\$ 2,994	\$ 3,658	\$ 3,523
	36 x 48 x 144	Angled 3"	71BT36144Q3.A6	3,287	4,068	3,905

* \$200 NET surcharge per order for oversized pallet

For Exclaim table options, please reference pages 152-153.

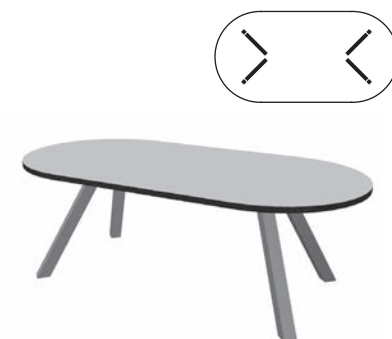
Top Size	Base	Model Number	3P	3K	3W	Racetrack with V Configuration
36 x 60	Angled 2"	71RT3660Q2.V	\$1,443	\$1,712	\$1,710	
36 x 72	Angled 2"	71RT3672Q2.V	1,443	1,712	1,739	
36 x 84	Angled 2"	71RT3684Q2.V	1,762	2,126	2,111	
36 x 90	Angled 2"	71RT3690Q2.V	1,895	2,310	2,272	
36 x 96 *	Angled 2"	71RT3696Q2.V	1,895	2,310	2,286	
42 x 84	Angled 3"	71RT4284Q3.V	1,789	2,151	2,146	
42 x 90	Angled 3"	71RT4290Q3.V	1,920	2,336	2,305	
42 x 96 *	Angled 3"	71RT4296Q3.V	1,920	2,336	2,320	
48 x 84	Angled 3"	71RT4884Q3.V	2,066	2,539	2,459	
48 x 90	Angled 3"	71RT4890Q3.V	2,066	2,539	2,473	
48 x 96 *	Angled 3"	71RT4896Q3.V	2,066	2,539	2,489	

Top Size	Base	Model Number	3P	3K	3W	Racetrack with V6 Configuration
42 x 120	Angled 3"	71RT42120Q3.V6	\$2,977	\$3,636	\$3,497	
42 x 144	Angled 3"	71RT42144Q3.V6	3,268	4,042	3,876	
48 x 120	Angled 3"	71RT48120Q3.V6	2,994	3,659	3,524	
48 x 144	Angled 3"	71RT48144Q3.V6	3,288	4,069	3,906	



Top Size	Base	Model Number	3P	3K	3W	Racetrack with A Configuration
42 x 84	Angled 3"	71RT4284Q3.A	\$1,789	\$2,151	\$2,146	
42 x 90	Angled 3"	71RT4290Q3.A	1,920	2,336	2,305	
42 x 96 *	Angled 3"	71RT4296Q3.A	1,920	2,336	2,320	
48 x 84	Angled 3"	71RT4884Q3.A	2,066	2,539	2,459	
48 x 90	Angled 3"	71RT4890Q3.A	2,066	2,539	2,473	
48 x 96 *	Angled 3"	71RT4896Q3.A	2,066	2,539	2,489	



Top Size	Base	Model Number	3P	3K	3W	Racetrack with A6 Configuration
42 x 120	Angled 3"	71RT42120Q3.A6	\$2,977	\$3,636	\$3,497	
42 x 144	Angled 3"	71RT42144Q3.A6	3,268	4,042	3,876	
48 x 120	Angled 3"	71RT48120Q3.A6	2,994	3,659	3,524	
48 x 144	Angled 3"	71RT48144Q3.A6	3,288	4,069	3,906	



* \$200 NET surcharge per order for oversized pallet

For Exclaim table options, please reference pages 152-153.

exclaim

Elliptical with X Configuration	Top Size	Base	Model Number	3P	3K	3W
	30 x 54	Angled 2"	71EL3054Q2.X	\$ 1,196	\$ 1,365	\$ 1,401
	30 x 60	Angled 2"	71EL3060Q2.X	1,241	1,428	1,462
	36 x 60	Angled 2"	71EL3660Q2.X	1,336	1,561	1,579
	36 x 72	Angled 2"	71EL3672Q2.X	1,443	1,712	1,720
	36 x 84	Angled 2"	71EL3684Q2.X	1,641	1,955	1,951
	36 x 90	Angled 2"	71EL3690Q2.X	1,749	2,105	2,082
	36 x 96 *	Angled 2"	71EL3696Q2.X	1,749	2,105	2,093

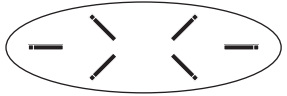
Elliptical with V Configuration	Top Size	Base	Model Number	3P	3K	3W
	42 x 72	Angled 3"	71EL4272Q3.V	\$ 1,582	\$ 1,896	\$ 1,881
	42 x 84	Angled 3"	71EL4284Q3.V	1,789	2,151	2,123
	42 x 90	Angled 3"	71EL4290Q3.V	1,922	2,339	2,282
	42 x 96 *	Angled 3"	71EL4296Q3.V	1,922	2,339	2,294
	48 x 72	Angled 3"	71EL4872Q3.V	1,690	2,046	2,011
	48 x 84	Angled 3"	71EL4884Q3.V	2,066	2,540	2,441
	48 x 90	Angled 3"	71EL4890Q3.V	2,066	2,540	2,452
	48 x 96 *	Angled 3"	71EL4896Q3.V	2,066	2,540	2,464

Elliptical with V6 Configuration	Top Size	Base	Model Number	3P	3K	3W
	42 x 120	Angled 3"	71EL42120Q3.V6	\$ 2,977	\$ 3,636	\$ 3,456
	42 x 144	Angled 3"	71EL42144Q3.V6	3,268	4,042	3,822
	48 x 120	Angled 3"	71EL48120Q3.V6	2,994	3,659	3,485
	48 x 144	Angled 3"	71EL48144Q3.V6	3,288	4,069	3,855

* \$200 NET surcharge per order for oversized pallet

For Exclaim table options, please reference pages 152-153.

exclaim

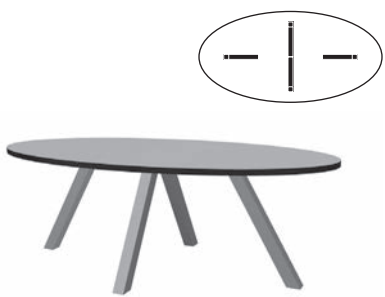

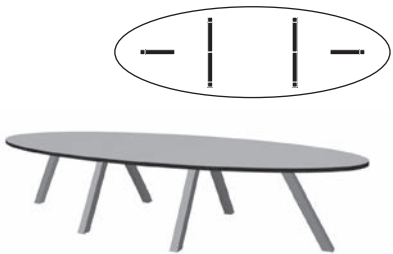
Top Size	Base	Model Number	3P	3K	3W	Elliptical with A Configuration
42 x 72	Angled 3"	71EL4272Q3.A	\$1,582	\$1,896	\$1,881	
42 x 84	Angled 3"	71EL4284Q3.A	1,789	2,151	2,123	
42 x 90	Angled 3"	71EL4290Q3.A	1,922	2,339	2,282	
42 x 96 *	Angled 3"	71EL4296Q3.A	1,922	2,339	2,294	
48 x 72	Angled 3"	71EL4872Q3.A	1,690	2,046	2,011	
48 x 84	Angled 3"	71EL4884Q3.A	2,066	2,540	2,441	
48 x 90	Angled 3"	71EL4890Q3.A	2,066	2,540	2,452	
48 x 96 *	Angled 3"	71EL4896Q3.A	2,066	2,540	2,464	



Top Size	Base	Model Number	3P	3K	3W	Elliptical with A6 Configuration
42 x 120	Angled 3"	71EL42120Q3.A6	\$2,977	\$3,636	\$3,456	
42 x 144	Angled 3"	71EL42144Q3.A6	3,268	4,042	3,822	
48 x 120	Angled 3"	71EL48120Q3.A6	2,994	3,659	3,485	
48 x 144	Angled 3"	71EL48144Q3.A6	3,288	4,069	3,855	

exclaim

* \$200 NET surcharge per order for oversized pallet

For Exclaim table options, please reference pages 152-153.

D-shaped with X Configuration	Top Size	Base	Model Number	3P	3K	3W
 	24 x 36	Angled 2"	71D2436Q2.X	\$ 996	\$ 1,085	\$ 1,153
	24 x 48	Angled 2"	71D2448Q2.X	1,069	1,189	1,265
	24 x 60	Angled 2"	71D2460Q2.X	1,144	1,293	1,376
	24 x 72	Angled 2"	71D2472Q2.X	1,218	1,397	1,487
	24 x 84	Angled 2"	71D2484Q2.X	1,154	1,273	1,438
	24 x 90	Angled 2"	71D2490Q2.X	1,415	1,637	1,739
	24 x 96 *	Angled 2"	71D2496Q2.X	1,452	1,690	1,795
	30 x 48	Angled 2"	71D3048Q2.X	1,144	1,293	1,358
	30 x 60	Angled 2"	71D3060Q2.X	1,237	1,423	1,490
	30 x 72	Angled 2"	71D3072Q2.X	1,330	1,553	1,622
	30 x 84	Angled 2"	71D3084Q2.X	1,507	1,768	1,838
	30 x 90	Angled 2"	71D3090Q2.X	1,554	1,833	1,904
	30 x 96 *	Angled 2"	71D3096Q2.X	1,601	1,898	1,970

D-shaped with V Configuration	Top Size	Base	Model Number	3P	3K	3W
 	36 x 48	Angled 2"	71D3648Q2.V	\$ 1,218	\$ 1,397	\$ 1,452
	36 x 60	Angled 2"	71D3660Q2.V	1,330	1,553	1,604
	36 x 72	Angled 2"	71D3672Q2.V	1,442	1,710	1,756
	36 x 84	Angled 2"	71D3684Q2.V	1,637	1,950	1,993
	36 x 90	Angled 2"	71D3690Q2.V	1,694	2,029	2,069
	36 x 96 *	Angled 2"	71D3696Q2.V	1,750	2,107	2,146
	42 x 60	Angled 3"	71D4260Q3.V	1,798	2,198	2,127
	42 x 72	Angled 3"	71D4272Q3.V	1,798	2,198	2,157
	42 x 84	Angled 3"	71D4284Q3.V	1,913	2,325	2,305
	42 x 90	Angled 3"	71D4290Q3.V	1,987	2,429	2,401
	42 x 96 *	Angled 3"	71D4296Q3.V	2,061	2,532	2,496
	48 x 60	Angled 3"	71D4860Q3.V	1,839	2,256	2,184
	48 x 72	Angled 3"	71D4872Q3.V	1,839	2,256	2,214
	48 x 84	Angled 3"	71D4884Q3.V	1,923	2,340	2,328
	48 x 90	Angled 3"	71D4890Q3.V	1,998	2,445	2,425
	48 x 96 *	Angled 3"	71D4896Q3.V	2,072	2,549	2,522
	54 x 54	Angled 3"	71D5454Q3.V	1,718	2,087	2,048
	60 x 60	Angled 3"	71D6060Q3.V	1,728	2,099	2,085

* \$200 NET surcharge per order for oversized pallet

For Exclaim table options, please reference pages 152-153.

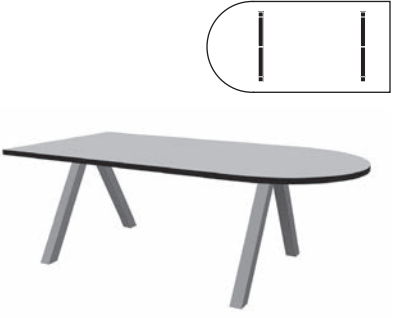
Top Size	Base	Model Number	3P	3K	3W	D-shaped with A Configuration
42 x 60	Angled 3"	71D4260Q3.A	\$ 1,798	\$ 2,198	\$ 2,127	
42 x 72	Angled 3"	71D4272Q3.A	1,798	2,198	2,157	
42 x 84	Angled 3"	71D4284Q3.A	1,913	2,325	2,305	
42 x 90	Angled 3"	71D4290Q3.A	1,987	2,429	2,401	
42 x 96 *	Angled 3"	71D4296Q3.A	2,061	2,532	2,496	
48 x 60	Angled 3"	71D4860Q3.A	1,839	2,256	2,184	
48 x 72	Angled 3"	71D4872Q3.A	1,839	2,256	2,214	
48 x 84	Angled 3"	71D4884Q3.A	1,923	2,340	2,328	
48 x 90	Angled 3"	71D4890Q3.A	1,998	2,445	2,425	
48 x 96 *	Angled 3"	71D4896Q3.A	2,072	2,549	2,522	
54 x 54	Angled 3"	71D5454Q3.A	1,718	2,087	2,048	
60 x 60	Angled 3"	71D6060Q3.A	1,728	2,099	2,085	

Top Size	Base	Model Number	3P	3K	3W	Square with 4 Columns
36 x 36	Angled 2"	71SQ3636Q2	\$ 1,022	\$ 1,122	\$ 1,225	
42 x 42	Angled 2"	71SQ4242Q2	1,109	1,244	1,350	
	Angled 3"	71SQ4242Q3	1,134	1,269	1,376	
48 x 48	Angled 2"	71SQ4848Q2	1,210	1,384	1,490	
	Angled 3"	71SQ4848Q3	1,235	1,410	1,516	
54 x 54	Angled 3"	71SQ5454Q3	1,349	1,569	1,670	
60 x 60	Angled 3"	71SQ6060Q3	1,475	1,746	1,839	

Top Size	Base	Model Number	3P	3K	3W	Round with 3 Columns
42 x 42	Angled 2"	71RD42Q2(3)	\$ 1,034	\$ 1,210	\$ 1,241	
48 x 48	Angled 3"	71RD48Q3(3)	1,085	1,274	1,319	

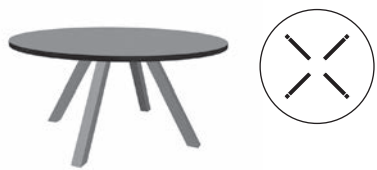
Top Size	Base	Model Number	3P	3K	3W	Round with 4 Columns
48 x 48	Angled 2"	71RD48Q2	\$ 1,244	\$ 1,433	\$ 1,477	
54 x 54	Angled 3"	71RD54Q3	1,459	1,724	1,734	
60 x 60	Angled 3"	71RD60Q3	1,485	1,760	1,787	

* \$200 NET surcharge per order for oversized pallet

For Exclaim table options, please reference pages 152-153.

exclaim



tablex

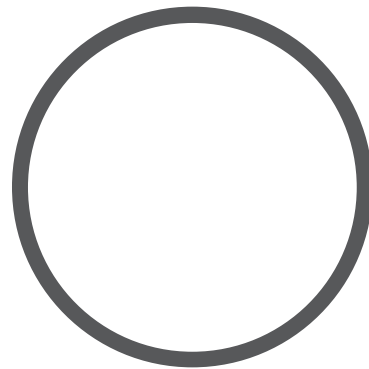

74 vertiGo
price list
Effective May 16, 2022

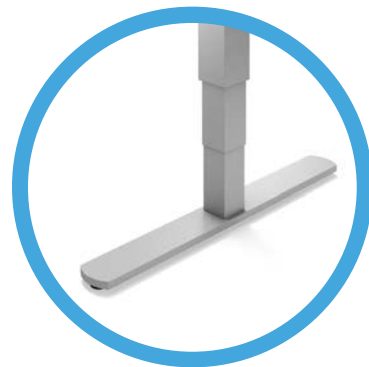



Adjusting one's work surface height has become the most personal and impactful detail within a workspace. VertiGo is designed to go from sit-to-stand, and any height in between, with ease. Match with static or nesting tables for a cohesive look throughout a space.

VertiGo Base Styles

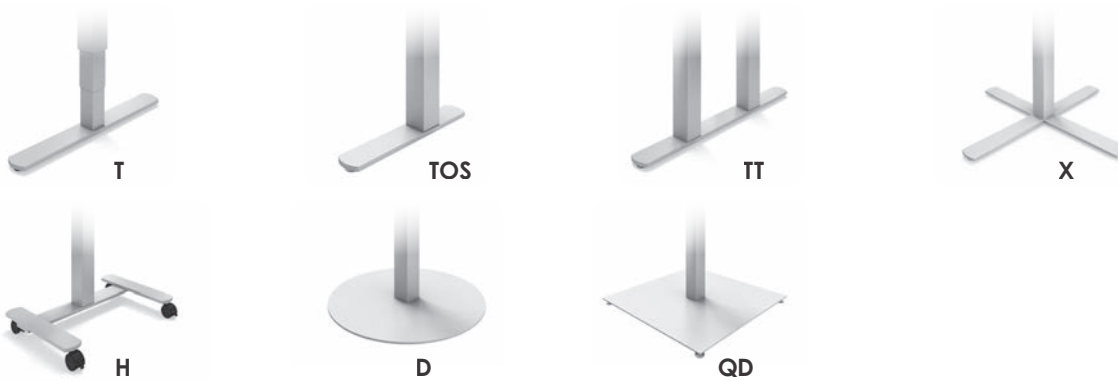

VertiGo Options

Standard Glides



Locking Casters



- LC Locking Casters**
can be added to any table for \$105 per set of four.
- FD Folding Bases**
are not available on VertiGo tables.
- NE Nesting Tables**
priced accordingly with locking casters.
- FT Flip Tops**
available on X-based and H-based tables for \$131. Not available on counterbalanced tables.

- WM Wire Management**
Built-in wire management is not available on VertiGo tables.
- MMLC Magnetic Wire Management Leg Covers**
Magnetically attaches onto any square leg and are \$67 each.
- OS Offset T-bases**
available for \$37 per table. Offset is not available on 18"d tables or 30"d nesting tables less than 60" wide.

- SH Special Height**
can be added to any table:
+ \$68 per column for heights > 29"
+ \$37 per column for heights < 29"
Special height tables with tops larger than 36x72" must be custom quoted.
- FR Footring**
is not available on VertiGo tables.
- CH Chrome Finish**
is not available on VertiGo tables.

VertiGo Height Adjustable Options

RA Ratchet
NE RA is available on T-bases and nesting for \$497 list per table. Available height adjustable finishes can be found on page 9.

CR Hand Crank
NE CR is available on most T-, X-, and L-bases and some nesting models as listed. Available height adjustable finishes can be found on page 9.

BL Counterbalanced and Short Balanced
BLS are available on disc and X-bases. Available height adjustable finishes can be found on page 9.

EH Electric Height is available on T- and TT-bases and are available in two finishes:

- 37 Satin Silver
- 57 Jet

Two-leg counterbalanced units are only available in three finishes:

- 30 Pearl
- 37 Satin Silver
- 57 Jet

VertiGo Top Shapes



Rectangle
p.170, 177



Boat
p.174



Racetrack
p.175



Elliptical
p.176



Kidney Bean
p.177



Square
p.178



Round
p.179



D-shaped
p.180



Half Round
p.182



Trapezoid
p.183



Squirele
p.183

VertiGo Top Options

RC 3" Radius Corners can be added to any table for \$58.

GN Ganging Plates & Knobs can be added to most table shapes for \$42 (includes 2 plates and 8 knobs per table).

LT Lightweight Tops can be added to any square or rectangular table for \$121.

QG Quick-Connect Ganging Brackets can be added to most table shapes for \$42 (includes 4 connectors per table).

GR Grommets can be added to any table for \$42 each. To see specific locations, see page 217.

VertiGo Edge Options

(corresponds with 3 columns of pricing)

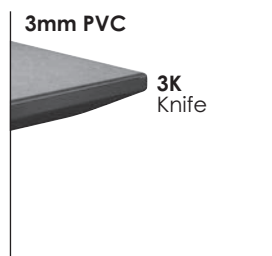
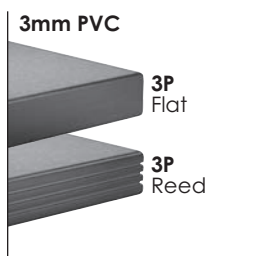

Ratchet Height Adjustability

Ratchet height adjustability is available on most tables in the VertiGo line... T-bases, X-bases, and even disc bases. Simply lift the top near the base's mounting plate, and the ratchet clicks into place. With a range of 9.45" the ratchet works in thirteen increments of .78". To reset to the lowest position just lift past its highest point.

will be adjusted to ensure that the range of mobile tables is consistent with that of static tables.

To specify:
All available ratchet models are priced in the following pages. They are denoted by the "RA" at the end of the model number.

Example:
74TC2060T18RA-3P
20x60" **ratchet** table
\$1,246 List Price

Want to use VertiGo on the go? Casters can be added, and the height of the base

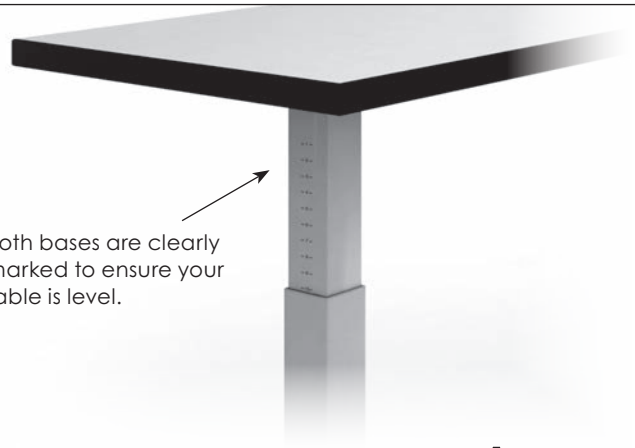

Both bases are clearly marked to ensure your table is level.

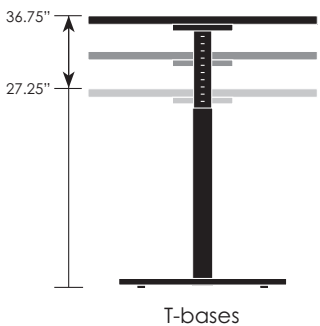

T-bases



X-bases
Disc Bases
H-bases

Nesting Ratchet

Ratchet height adjustability is also available on many of the nesting T-base models in the VertiGo line. All available nesting models are denoted by the "NE" at the end of the model number. To add the ratchet option to those models, change the "NE" to "NERA" and add \$497 to the list price.

Example:
74TC2060T18NERA-3P
20x60" **nesting ratchet** table
\$1,367 + 497 = \$1,864 List Price

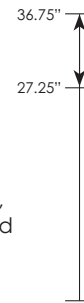
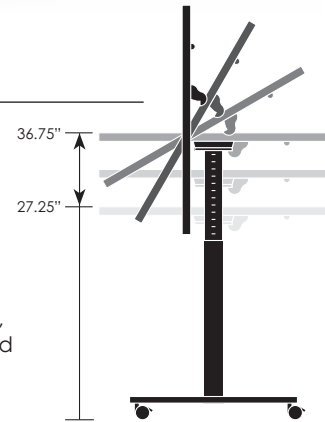

Manual Hand Crank Height Adjustability

Need the flexibility of infinite adjustability without the budget for counterbalanced bases? Our manual hand crank offers a cost-effective alternative.

To specify:
All available hand crank models are priced in the following pages. They are denoted by the

"CR" at the end of the model number.

Example:
74TC2060T18CR-3P
20x60" **hand crank** table
\$1,403 List Price

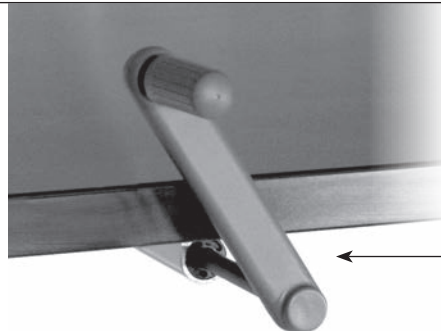

Raise and lower with turn of the crank

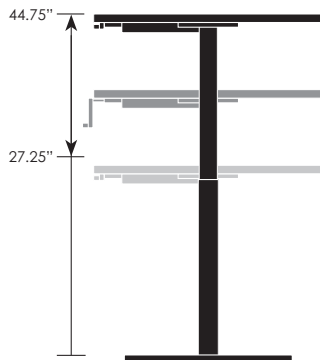

Crank Bases

Nesting Hand Crank

Introducing hand crank height adjustable tables that nest! Only available on rectangular tables 20x60" to 36-72". These models are denoted by the "NECR" at the end of the model number.

Example:
74TC2060T18NECR-3P
20x60" **nesting hand crank** table
\$1,953 List Price



Electric Height Adjustability

Electric height adjustability gives you the ability to adjust tables at the push of a button. The standard memory keypad will remember your four favorite heights. Available on both VertiGo T and TT-bases, this option works great in private offices or even in conference rooms.

To specify:
All available electric models are priced in the following pages. They are denoted by the "EH" at the end of the model number.

Example:
74TC2060T18EH-3P
20x60" **electric height** table
\$2,432 List Price

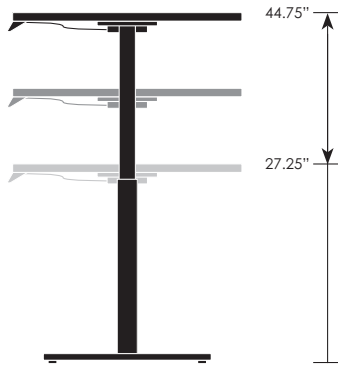

Electric T-bases

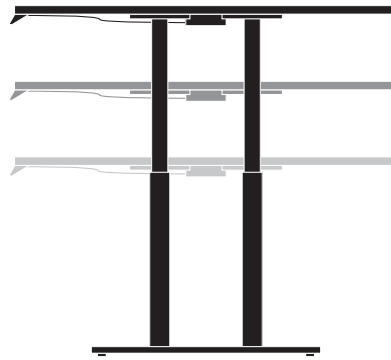

Electric TT-bases

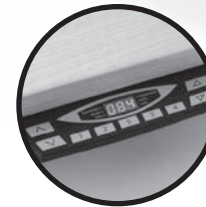

Retractable Memory Keypad

Counterbalanced & Short Balanced Height Adjustability

Counterbalanced tables go from seated-to-standing height, while the short balanced goes from coffee-to-seated height. Available on tables using single column disc or X-bases, these tables are easy to adjust. Simply squeeze the small handle underneath and gently move the top to your desired height. It's that easy.

Want to use VertiGo on the go? Simply add 2" to each vertical measurement to account for the added height of locking casters.

To specify:
All available counterbalanced models are priced in the following pages. They are denoted by the "BL" or "BLS" (for short balanced) at the end of the model number.

Example:
74RD36X32BL-3P
36" round **counterbalanced** table
\$1,366 List Price

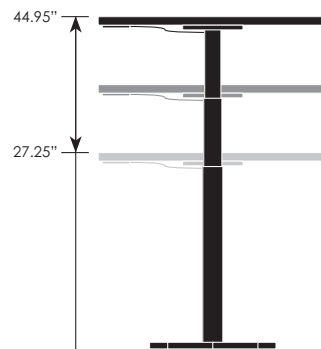
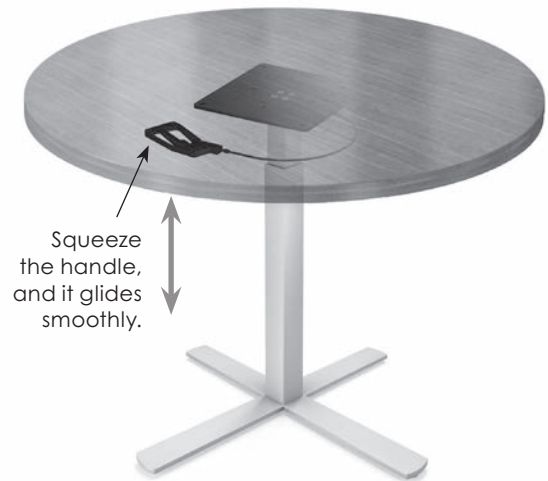

BL Counterbalanced disc or X-bases

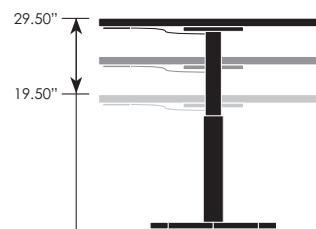

BLS Short balanced disc or X-bases

Rectangular with T-bases	Top Size	Base	Model Number	3P	3K	3W
	20 x 36	Static	74TC2036T18	\$ 698	\$ 766	\$ 853
		Nesting	74TC2036T18NE	1,357	1,424	1,509
		Ratchet	74TC2036T18RA	1,229	1,297	1,384
		Crank	74TC2036T18CR	1,394	1,461	1,548
		Electric	74TC2036T18EH	2,474	2,541	2,629
	20 x 48	Static	74TC2048T18	753	843	943
		Nesting	74TC2048T18NE	1,412	1,499	1,598
		Ratchet	74TC2048T18RA	1,284	1,374	1,474
		Crank	74TC2048T18CR	1,448	1,538	1,638
		Count Bal	74TC2048T18BL	2,517	2,607	2,707
		Electric	74TC2048T18EH	2,529	2,618	2,719
	20 x 60	Static	74TC2060T18	779	877	1,000
		Nesting	74TC2060T18NE	1,436	1,533	1,654
		Ratchet	74TC2060T18RA	1,309	1,409	1,531
		Crank	74TC2060T18CR	1,474	1,573	1,696
Nest/Crank		74TC2060T18NECR	2,051	2,149	2,270	
Count Bal		74TC2060T18BL	2,592	2,692	2,814	
Electric		74TC2060T18EH	2,554	2,654	2,777	
20 x 72	Static	74TC2072T18	826	943	1,082	
	Nesting	74TC2072T18NE	1,706	1,822	1,958	
	Ratchet	74TC2072T18RA	1,441	1,559	1,697	
	Crank	74TC2072T18CR	1,605	1,724	1,861	
	Nest/Crank	74TC2072T18NECR	2,138	2,254	2,389	
	Count Bal	74TC2072T18BL	2,726	2,845	2,984	
	Electric	74TC2072T18EH	2,685	2,804	2,942	
20 x 84	Static	74TC2084T18	1,001	1,157	1,296	
	Nesting	74TC2084T18NE	1,796	1,948	2,086	
	Electric	74TC2084T18EH	2,777	2,932	3,073	
20 x 90	Static	74TC2090T18	1,056	1,232	1,372	
	Nesting	74TC2090T18NE	1,850	2,023	2,159	
	Electric	74TC2090T18EH	2,831	3,009	3,147	
20 x 96 *	Static	74TC2096T18	1,056	1,232	1,386	
	Nesting	74TC2096T18NE	1,850	2,023	2,174	
	Electric	74TC2096T18EH	2,831	3,009	3,162	
24 x 36	Static	74TC2436T22	717	785	882	
	Nesting	74TC2436T22NE	1,376	1,442	1,538	
	Ratchet	74TC2436T22RA	1,248	1,316	1,413	
	Crank	74TC2436T22CR	1,409	1,477	1,574	
	Electric	74TC2436T22EH	2,490	2,557	2,655	
24 x 48	Static	74TC2448T22	771	861	972	
	Nesting	74TC2448T22NE	1,430	1,518	1,626	
	Ratchet	74TC2448T22RA	1,302	1,393	1,503	
	Crank	74TC2448T22CR	1,464	1,553	1,664	
	Count Bal	74TC2448T22BL	2,532	2,621	2,732	
	Electric	74TC2448T22EH	2,545	2,634	2,744	

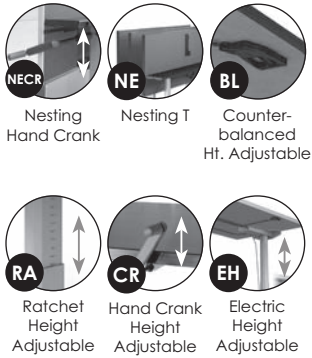

* \$200 NET surcharge per order for oversized pallet

For VertiGo table options, please reference pages 166-167.

Top Size	Base	Model Number	3P	3K	3W
24 x 60	Static	74TC2460T22	\$ 797	\$ 896	\$ 1,029
	Nesting	74TC2460T22NE	1,455	1,552	1,683
	Ratchet	74TC2460T22RA	1,329	1,427	1,561
	Crank	74TC2460T22CR	1,489	1,588	1,721
	Nest/Crank	74TC2460T22NECR	2,068	2,166	2,296
	Count Bal	74TC2460T22BL	2,610	2,708	2,842
	Electric	74TC2460T22EH	2,570	2,670	2,802
	Battery/Nest	74TC2460T22BEHNE	3,640	3,740	3,872
24 x 72	Static	74TC2472T22	845	962	1,110
	Nesting	74TC2472T22NE	1,725	1,841	1,986
	Ratchet	74TC2472T22RA	1,375	1,494	1,642
	Crank	74TC2472T22CR	1,537	1,654	1,802
	Nest/Crank	74TC2472T22NECR	2,155	2,272	2,417
	Count Bal	74TC2472T22BL	2,660	2,778	2,927
	Electric	74TC2472T22EH	2,617	2,736	2,884
	Battery/Nest	74TC2472T22BEHNE	3,915	4,034	4,182
24 x 84	Static	74TC2484T22	1,020	1,175	1,326
	Nesting	74TC2484T22NE	1,814	1,966	2,114
	Electric	74TC2484T22EH	2,792	2,948	3,098
24 x 90	Static	74TC2490T22	1,075	1,251	1,400
	Nesting	74TC2490T22NE	1,867	2,042	2,188
	Electric	74TC2490T22EH	2,847	3,024	3,173
24 x 96 *	Static	74TC2496T22	1,075	1,251	1,415
	Nesting	74TC2496T22NE	1,867	2,042	2,201
	Electric	74TC2496T22EH	2,847	3,024	3,187
30 x 36	Static	74TC3036T26	776	860	960
	Nesting	74TC3036T26NE	1,435	1,517	1,614
	Ratchet	74TC3036T26RA	1,309	1,393	1,493
	Crank	74TC3036T26CR	1,467	1,550	1,651
	Electric	74TC3036T26EH	2,549	2,633	2,734
30 x 48	Static	74TC3048T26	845	955	1,064
	Nesting	74TC3048T26NE	1,501	1,609	1,717
	Ratchet	74TC3048T26RA	1,376	1,487	1,596
	Crank	74TC3048T26CR	1,535	1,646	1,755
	Count Bal	74TC3048T26BL	2,601	2,712	2,821
30 x 60	Static	74TC3060T26	866	984	1,118
	Nesting	74TC3060T26NE	1,522	1,638	1,769
	Ratchet	74TC3060T26RA	1,397	1,517	1,649
	Crank	74TC3060T26CR	1,556	1,675	1,808
	Nest/Crank	74TC3060T26NECR	2,132	2,250	2,380
	Count Bal	74TC3060T26BL	2,632	2,751	2,884
	Electric	74TC3060T26EH	2,638	2,758	2,890
	Battery/Nest	74TC3060T26BEHNE	3,706	3,826	3,958

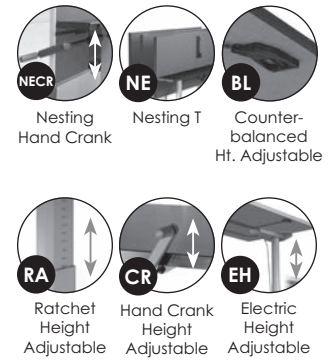

* \$200 NET surcharge per order for oversized pallet

For VertiGo table options, please reference pages 166-167.



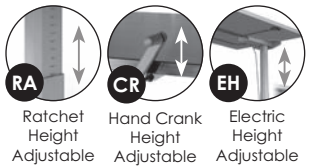
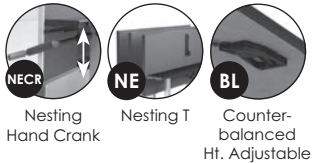

Rectangular with T-bases	Top Size	Base	Model Number	3P	3K	3W	
	30 x 72	Static	74TC3072T26	\$ 918	\$1,059	\$1,205	
		Nesting	74TC3072T26NE	1,797	1,935	2,078	
		Ratchet	74TC3072T26RA	1,451	1,591	1,737	
		Crank	74TC3072T26CR	1,609	1,749	1,896	
		Nest/Crank	74TC3072T26NECR	2,224	2,362	2,506	
		Count Bal	74TC3072T26BL	2,729	2,869	3,016	
		Electric	74TC3072T26EH	2,691	2,831	2,978	
		Battery/Nest	74TC3072T26BEHNE	3,987	4,128	4,274	
		30 x 84	Static	74TC3084T26	1,131	1,323	1,461
			Nesting	74TC3084T26NE	1,924	2,112	2,246
Electric	74TC3084T26EH		2,904	3,096	3,233		
30 x 90	Static	74TC3090T26	1,200	1,419	1,550		
	Nest/Lightwt	74TC3090T26NE-LT	2,205	N/A	2,571		
	Electric	74TC3090T26EH	2,972	3,191	3,323		
30 x 96 *	Static	74TC3096T26	1,200	1,419	1,565		
	Nest/Lightwt	74TC3096T26NE-LT	2,205	N/A	2,586		
	Electric	74TC3096T26EH	2,972	3,191	3,337		
36 x 48	Static	74TC3648T26	898	1,029	1,138		
	Nesting	74TC3648T26NE	1,679	1,809	1,915		
	Ratchet	74TC3648T26RA	1,430	1,562	1,670		
	Crank	74TC3648T26CR	1,588	1,720	1,829		
	Count Bal	74TC3648T26BL	2,655	2,787	2,895		
	Electric	74TC3648T26EH	2,671	2,803	2,911		
36 x 60	Static	74TC3660T26	978	1,143	1,256		
	Nesting	74TC3660T26NE	1,831	1,991	2,104		
	Ratchet	74TC3660T26RA	1,510	1,675	1,789		
	Crank	74TC3660T26CR	1,669	1,834	1,947		
	Nest/Crank	74TC3660T26NECR	2,283	2,445	2,556		
	Count Bal	74TC3660T26BL	2,745	2,909	3,023		
	Electric	74TC3660T26EH	2,751	2,915	3,030		
	Battery/Nest	74TC3660T26BEHNE	4,021	4,186	4,299		
	36 x 72	Static	74TC3672T26	1,029	1,214	1,342	
		Nesting	74TC3672T26NE	1,906	2,088	2,213	
Ratchet		74TC3672T26RA	1,562	1,747	1,875		
Crank		74TC3672T26CR	1,720	1,905	2,032		
Nest/Crank		74TC3672T26NECR	2,334	2,515	2,640		
Count Bal		74TC3672T26BL	2,840	3,026	3,153		
Electric		74TC3672T26EH	2,802	2,987	3,115		
Battery/Nest		74TC3672T26BEHNE	4,099	4,283	4,412		
36 x 84		Static	74TC3684T26	1,225	1,454	1,578	
	Nest/Lightwt	74TC3684T26NE-LT	2,239	N/A	2,609		
	Electric	74TC3684T26EH	2,997	3,226	3,350		
36 x 90	Static	74TC3690T26	1,305	1,565	1,680		
	Nest/Lightwt	74TC3690T26NE-LT	2,349	N/A	2,744		
	Electric	74TC3690T26EH	3,077	3,337	3,453		
36 x 96 *	Static	74TC3696T26	1,305	1,565	1,695		
	Nest/Lightwt	74TC3696T26NE-LT	2,349	N/A	2,758		
	Electric	74TC3696T26EH	3,077	3,337	3,468		





vertiGo

* \$200 NET surcharge per order for oversized pallet



For VertiGo table options, please reference pages 166-167.

Top Size	Base	Model Number	3P	3K	3W	Rectangular with TT-bases
42 x 60	Static	74TC4260TT32	\$ 1,796	\$ 1,989	\$ 2,096	    Nesting TT Electric Height Adjustable
	Nesting	74TC4260TT32NE	2,817	3,006	3,111	
	Electric	74TC4260TT32EH	5,144	5,337	5,444	
42 x 72	Static	74TC4272TT32	1,893	2,124	2,232	
	Nesting	74TC4272TT32NE	2,911	3,137	3,243	
	Electric	74TC4272TT32EH	5,240	5,471	5,579	
42 x 84	Static	74TC4284TT32	2,069	2,337	2,447	
	Electric	74TC4284TT32EH	5,416	5,685	5,794	
42 x 90	Static	74TC4290TT32	2,158	2,463	2,560	
	Electric	74TC4290TT32EH	5,507	5,810	5,908	
42 x 96 *	Static	74TC4296TT32	2,158	2,463	2,575	
	Electric	74TC4296TT32EH	5,507	5,810	5,922	
48 x 60	Static	74TC4860TT36	1,833	2,035	2,150	
	Nesting	74TC4860TT36NE	2,851	3,051	3,162	
	Electric	74TC4860TT36EH	7,441	7,644	7,758	
48 x 72	Static	74TC4872TT36	1,985	2,250	2,347	
	Nesting	74TC4872TT36NE	3,001	3,260	3,356	
	Electric	74TC4872TT36EH	7,594	7,858	7,956	
48 x 84	Static	74TC4884TT36	2,078	2,347	2,471	
	Electric	74TC4884TT36EH	7,688	7,955	8,080	
48 x 90	Static	74TC4890TT36	2,170	2,474	2,587	
	Electric	74TC4890TT36EH	7,779	8,082	8,195	
48 x 96 *	Static	74TC4896TT36	2,170	2,474	2,601	
	Electric	74TC4896TT36EH	7,779	8,082	8,209	

Top Size	Base	Model Number	3P	3K	3W	Rectangular with 3 TT-bases
42 x 120	Static	74TC42120TT32(3)	\$ 3,154	\$ 3,604	\$ 3,666	  
42 x 144	Static	74TC42144TT32(3)	3,338	3,863	3,929	
48 x 120	Static	74TC48120TT36(3)	3,179	3,635	3,708	
48 x 144	Static	74TC48144TT36(3)	3,366	3,896	3,973	



* \$200 NET surcharge per order for oversized pallet

For VertiGo table options, please reference pages 166-167.

Boat-shaped with T-bases	Top Size	Base	Model Number	3P	3K	3W
 	30 x 42 x 84	Static	74BT3084T26	\$ 1,561	\$ 1,925	\$ 1,919
		Electric	74BT3084T26EH	3,333	3,698	3,691
	30 x 42 x 90	Static	74BT3090T26	1,690	2,105	2,075
		Electric	74BT3090T26EH	3,462	3,878	3,848
	30 x 42 x 96 *	Static	74BT3096T26	1,690	2,105	2,090
		Electric	74BT3090T26EH	3,462	3,878	3,862





Electric Height Adjustable

Boat-shaped with TT-bases	Top Size	Base	Model Number	3P	3K	3W
 	36 x 48 x 84	Static	74BT3684TT36	\$2,446	\$2,861	\$2,825
		Electric	74BT3684TT36EH	8,055	8,470	8,433
	36 x 48 x 90	Static	74BT3690TT36	2,593	3,066	3,001
		Electric	74BT3690TT36EH	8,202	8,676	8,609
	36 x 48 x 96 *	Static	74BT3696TT36	2,593	3,066	3,016
		Electric	74BT3696TT36EH	8,202	8,676	8,624





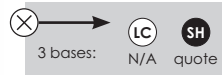







Electric Height Adjustable

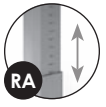
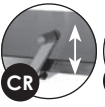

Boat-shaped with 3 TT-bases	Top Size	Base	Model Number	3P	3K	3W
 	36 x 48 x 120	Static	74BT36120TT36(3)	\$3,701	\$4,364	\$4,230
	36 x 48 x 144	Static	74BT36144TT36(3)	3,994	4,775	4,612
	 <p>3 bases: LC N/A SH quote</p>					

* \$200 NET surcharge per order for oversized pallet

For VertiGo table options, please reference pages 166-167.

Top Size	Base	Model Number	3P	3K	3W	Racetrack with T-bases
36 x 60	Static	74RT3672T26	\$1,238	\$1,507	\$1,504	 
	Nesting	74RT3660T26NE	2,013	2,277	2,275	
	Ratchet	74RT3672T26RA	1,771	2,040	2,036	
	Crank	74RT3672T26CR	1,929	2,197	2,195	
	Count Bal	74RT3660T26BL	3,005	3,273	3,271	
	Electric	74RT3672T26EH	3,011	3,280	3,278	
36 x 72	Static	74RT3672T26	1,238	1,507	1,535	
	Nesting	74RT3672T26NE	2,086	2,349	2,376	
	Ratchet	74RT3672T26RA	1,771	2,040	2,066	
	Crank	74RT3672T26CR	1,929	2,197	2,224	
	Count Bal	74RT3672T26BL	3,050	3,317	3,345	
	Electric	74RT3672T26EH	3,011	3,280	3,307	
36 x 84	Static	74RT3684T26	1,558	1,921	1,906	  
	Electric	74RT3684T26EH	3,330	3,693	3,680	
36 x 90	Static	74RT3690T26	1,690	2,105	2,067	  
	Electric	74RT3690T26EH	3,462	3,878	3,839	
36 x 96 *	Static	74RT3696T26	1,690	2,105	2,082	
	Electric	74RT3696T26EH	3,462	3,878	3,854	

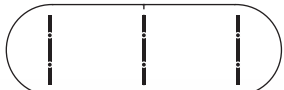

Top Size	Base	Model Number	3P	3K	3W	Racetrack with TT-bases
42 x 84	Static	74RT4284TT32	\$2,305	\$2,669	\$2,662	 
	Electric	74RT4284TT32EH	5,654	6,016	6,011	
42 x 90	Static	74RT4290TT32	2,438	2,853	2,823	
	Electric	74RT4290TT32EH	5,785	6,201	6,170	
42 x 96 *	Static	74RT4296TT32	2,438	2,853	2,838	
	Electric	74RT4296TT32EH	5,785	6,201	6,185	
48 x 84	Static	74RT4884TT36	2,593	3,066	2,986	
	Electric	74RT4884TT36EH	8,202	8,676	8,595	
48 x 90	Static	74RT4890TT36	2,593	3,066	3,001	
	Electric	74RT4890TT36EH	8,202	8,676	8,609	
48 x 96 *	Static	74RT4896TT36	2,593	3,066	3,016	
	Electric	74RT4896TT36EH	8,202	8,676	8,624	

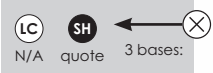

Top Size	Base	Model Number	3P	3K	3W	Racetrack with TT-bases
42 x 120	Static	74RT42120TT32(3)	\$3,669	\$4,328	\$4,189	 
42 x 144	Static	74RT42144TT32(3)	3,960	4,734	4,568	
48 x 120	Static	74RT48120TT36(3)	3,701	4,365	4,231	
48 x 144	Static	74RT48144TT36(3)	3,995	4,776	4,613	

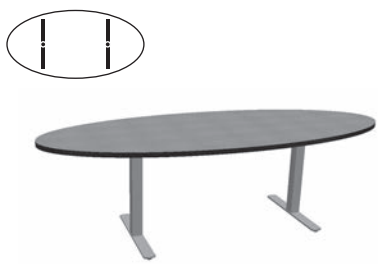
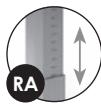

* \$200 NET surcharge per order for oversized pallet

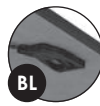
For VertiGo table options, please reference pages 166-167.

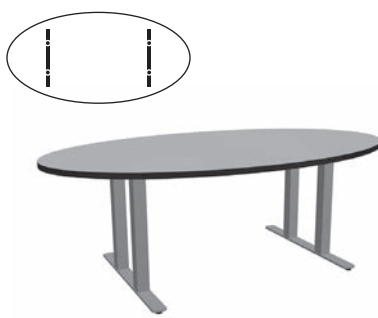
Elliptical with T-bases	Top Size	Base	Model Number	3P	3K	3W
 <div style="display: flex; justify-content: space-around; margin-top: 10px;"> <div style="text-align: center;">  <p>RA Ratchet Height Adjustable</p> </div> <div style="text-align: center;">  <p>EH Electric Height Adjustable</p> </div> <div style="text-align: center;">  <p>BL Counter- balanced Ht. Adjustable</p> </div> </div>	30 x 54	Static	74EL3054T22	\$ 972	\$ 1,142	\$ 1,178
		Ratchet	74EL3054T22RA	1,503	1,673	1,709
		Count Bal	74EL3054T22BL	2,737	2,907	2,987
		Electric	74EL3054T22EH	2,745	2,914	2,950
	30 x 60	Static	74EL3060T22	1,017	1,205	1,238
		Ratchet	74EL3060T22RA	1,548	1,736	1,770
		Count Bal	74EL3060T22BL	2,829	3,017	3,098
		Electric	74EL3060T22EH	2,789	2,977	3,011
	36 x 60	Static	74EL3660T26	1,130	1,356	1,373
		Ratchet	74EL3660T26RA	1,663	1,888	1,905
		Count Bal	74EL3660T26BL	2,897	3,122	3,190
		Electric	74EL3660T26EH	2,904	3,128	3,146
36 x 72	Static	74EL3672T26	1,238	1,507	1,516	
	Ratchet	74EL3672T26RA	1,771	2,040	2,047	
	Count Bal	74EL3672T26BL	3,050	3,317	3,383	
	Electric	74EL3672T26EH	3,011	3,280	3,288	
36 x 84	Static	74EL3684T26	1,436	1,749	1,747	
	Electric	74EL3684T26EH	3,208	3,522	3,519	
36 x 90	Static	74EL3690T26	1,543	1,900	1,877	
	Electric	74EL3690T26EH	3,316	3,673	3,649	
36 x 96 *	Static	74EL3696T26	1,543	1,900	1,888	
	Electric	74EL3696T26EH	3,316	3,673	3,661	

Elliptical with TT-bases	Top Size	Base	Model Number	3P	3K	3W
 <div style="margin-top: 10px;">  <p>EH Electric Height Adjustable</p> </div>	42 x 72	Static	74EL4272TT32	\$2,099	\$ 2,412	\$2,399
		Electric	74EL4272TT32EH	5,447	5,761	5,746
	42 x 84	Static	74EL4284TT32	2,305	2,669	2,640
		Electric	74EL4284TT32EH	5,654	6,016	5,988
	42 x 90	Static	74EL4290TT32	2,440	2,856	2,800
		Electric	74EL4290TT32EH	5,787	6,204	6,147
	42 x 96 *	Static	74EL4296TT32	2,440	2,856	2,811
		Electric	74EL4296TT32EH	5,787	6,204	6,159
	48 x 72	Static	74EL4872TT36	2,217	2,573	2,538
		Electric	74EL4872TT36EH	7,825	8,182	8,147
	48 x 84	Static	74EL4884TT36	2,593	3,068	2,968
		Electric	74EL4884TT36EH	8,202	8,676	8,577
	48 x 90	Static	74EL4890TT36	2,593	3,068	2,979
		Electric	74EL4890TT36EH	8,202	8,676	8,588
	48 x 96 *	Static	74EL4896TT36	2,593	3,068	2,991
		Electric	74EL4896TT36EH	8,202	8,676	8,600

* \$200 NET surcharge per order for oversized pallet

For VertiGo table options, please reference pages 166-167.







Top Size	Base	Model Number	3P	3K	3W	Elliptical with 3 TT-bases
42 x 120	Static	74EL42120TT32(3)	\$ 3,669	\$ 4,328	\$ 4,148	
42 x 144	Static	74EL42144TT32(3)	3,960	4,734	4,514	
48 x 120	Static	74EL48120TT36(3)	3,701	4,365	4,192	
48 x 144	Static	74EL48144TT36(3)	3,995	4,776	4,562	







LC N/A SH quote 3 bases: X





Top Size	Base	Model Number	3P	3K	3W	Rectangle with H-base
18 x 30	Static	74TC1830H1524	\$ 1,002	\$ 1,054	\$ 1,133	
	Ratchet	74TC1830H1524RA	1,197	1,249	1,329	
	Count Bal	74TC1830H1524BL	1,586	1,637	1,717	
18 x 36	Static	74TC1836H1524	1,002	1,054	1,148	
	Ratchet	74TC1836H1524RA	1,197	1,249	1,343	
	Count Bal	74TC1836H1524BL	1,586	1,637	1,733	
20 x 30	Static	74TC2030H1524	1,015	1,071	1,152	
	Ratchet	74TC2030H1524RA	1,211	1,267	1,349	
	Count Bal	74TC2030H1524BL	1,600	1,656	1,737	
20 x 36	Static	74TC2036H1524	1,043	1,110	1,197	
	Ratchet	74TC2036H1524RA	1,238	1,306	1,393	
	Count Bal	74TC2036H1524BL	1,627	1,694	1,782	

Top Size	Base	Model Number	3P	3K	3W	Kidney Bean with H-base
18 x 30	Static	74KB1830H1524	\$ 1,194	\$ 1,322	\$ 1,356	
	Ratchet	74KB1830H1524RA	1,390	1,518	1,551	
	Count Bal	74KB1830H1524BL	1,778	1,906	1,941	
18 x 36	Static	74KB1836H1524	1,207	1,340	1,386	
	Ratchet	74KB1836H1524RA	1,402	1,536	1,582	
	Count Bal	74KB1836H1524BL	1,791	1,924	1,971	
20 x 30	Static	74KB2030H1524	1,196	1,326	1,364	
	Ratchet	74KB2030H1524RA	1,392	1,521	1,560	
	Count Bal	74KB2030H1524BL	1,780	1,909	1,948	
20 x 36	Static	74KB2036H1524	1,211	1,346	1,397	
	Ratchet	74KB2036H1524RA	1,406	1,541	1,592	
	Count Bal	74KB2036H1524BL	1,795	1,930	1,981	

For VertiGo table options, please reference pages 166-167.

Square with X-base		Top Size	Base	Model Number	3P	3K	3W
   Ratchet Height Adjustable  Hand Crank Height Adjustable  Short Balanced Ht. Adjustable  Counter-balanced Ht. Adjustable	24 x 24	Static	74SQ2424X22	\$ 711	\$ 758	\$ 842	
		Ratchet	74SQ2424X22RA	908	953	1,037	
		Crank	74SQ2424X22CR	980	1,025	1,110	
		Short Bal	74SQ2424X22BLS	1,193	1,239	1,323	
	30 x 30	Static	74SQ3030X26	792	863	958	
		Ratchet	74SQ3030X26RA	987	1,058	1,153	
		Crank	74SQ3030X26CR	1,059	1,129	1,225	
		Short Bal	74SQ3030X26BLS	1,270	1,340	1,436	
	36 x 36	Static	74SQ3636X32	886	985	1,088	
		Short Bal	74SQ3636X32BLS	1,362	1,462	1,565	
		Count Bal	74SQ3636X32BL	1,362	1,462	1,565	
	42 x 42	Static	74SQ4242X36	992	1,126	1,232	
Short Bal		74SQ4242X36BLS	1,465	1,600	1,706		
Count Bal		74SQ4242X36BL	1,465	1,600	1,706		

Square with Square Disc Base		Top Size	Base	Model Number	3P	3K	3W
   Short Balanced Ht. Adjustable  Counter-balanced Ht. Adjustable  Ratchet Height Adjustable  Disc base: +68	24 x 24	Static	74SQ2424QD16	\$ 724	\$ 770	\$ 854	
		Ratchet	74SQ2424QD16RA	926	972	1,056	
		Short Bal	74SQ2424QD16BLS	1,370	1,415	1,499	
	30 x 30	Static	74SQ3030QD16	786	855	951	
		Ratchet	74SQ3030QD16RA	986	1,057	1,152	
		Short Bal	74SQ3030QD16BLS	1,431	1,501	1,596	
	36 x 36	Static	74SQ3636QD20	898	998	1,101	
		Short Bal	74SQ3636QD20BLS	1,544	1,645	1,747	
		Count Bal	74SQ3636QD20BL	1,544	1,645	1,747	
	42 x 42	Static	74SQ4242QD26	1,113	1,248	1,354	
		Short Bal	74SQ4242QD26BLS	1,752	1,887	1,993	
		Count Bal	74SQ4242QD26BL	1,752	1,887	1,993	

Square with TT-bases		Top Size	Base	Model Number	3P	3K	3W
   Nesting TT  Electric Height Adjustable	48 x 48	Static	74SQ4848TT36	\$ 1,762	\$ 1,937	\$ 2,043	
		Nesting	74SQ4848TT36NE	2,782	2,954	3,058	
		Electric	74SQ4848TT36EH	7,370	7,546	7,652	

For VertiGo table options, please reference pages 166-167.

Top Size	Base	Model Number	3P	3K	3W	Round with X-base
24 x 24	Static	74RD24X22	\$ 749	\$ 810	\$ 857	
	Ratchet	74RD24X22RA	944	1,005	1,054	
	Crank	74RD24X22CR	1,018	1,079	1,126	
	Short Bal	74RD24X22BLS	1,231	1,292	1,339	
30 x 30	Static	74RD30X26	852	945	992	
	Ratchet	74RD30X26RA	1,047	1,141	1,187	
	Crank	74RD30X26CR	1,119	1,212	1,258	
	Short Bal	74RD30X26BLS	1,330	1,424	1,469	
36 x 36	Static	74RD36X32	958	1,087	1,130	
	Short Bal	74RD36X32BLS	1,435	1,564	1,607	
	Count Bal	74RD36X32BL	1,435	1,564	1,607	
42 x 42	Static	74RD42X32	1,075	1,250	1,281	
	Short Bal	74RD42X32BLS	1,551	1,727	1,758	
	Count Bal	74RD42X32BL	1,551	1,727	1,758	
48 x 48	Static	74RD48X36	1,126	1,315	1,359	
	Short Bal	74RD48X36BLS	1,600	1,789	1,833	
	Count Bal	74RD48X36BL	1,600	1,789	1,833	

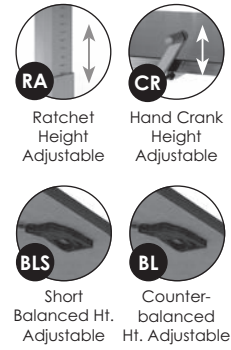



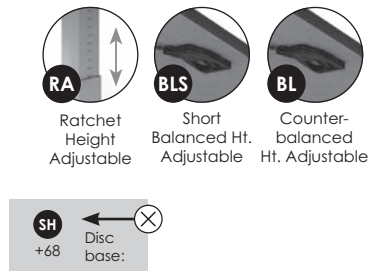

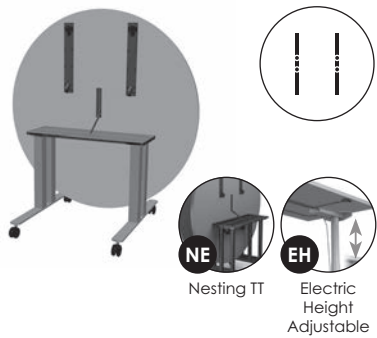



















Top Size	Base	Model Number	3P	3K	3W	Round with Disc Base
24 x 24	Static	74RD24D20	\$ 762	\$ 823	\$ 870	
	Ratchet	74RD24D20RA	963	1,024	1,071	
	Short Bal	74RD24D20BLS	1,350	1,411	1,458	
30 x 30	Static	74RD30D20	845	939	985	
	Ratchet	74RD30D20RA	1,046	1,141	1,186	
	Short Bal	74RD30D20BLS	1,434	1,527	1,573	
36 x 36	Static	74RD36D24	972	1,101	1,143	
	Short Bal	74RD36D24BLS	1,860	1,989	2,032	
	Count Bal	74RD36D24BL	1,860	1,989	2,032	
42 x 42	Static	74RD42D24	1,087	1,264	1,294	
	Short Bal	74RD42D24BLS	1,977	2,152	2,183	
	Count Bal	74RD42D24BL	1,977	2,152	2,183	
48 x 48	Static	74RD48D32	1,248	1,437	1,481	
	Short Bal	74RD48D32BLS	2,131	2,319	2,364	
	Count Bal	74RD48D32BL	2,131	2,319	2,364	



Top Size	Base	Model Number	3P	3K	3W	Round with TT-bases
48 x 48	Static	74RD48TT32	\$ 1,787	\$ 1,976	\$ 2,020	
	Nesting	74RD48TT32NE	2,806	2,992	3,035	
	Electric	74RD48TT32EH	5,134	5,323	5,367	
54 x 54	Static	74RD54TT32	1,977	2,241	2,252	
	Nesting	74RD54TT32NE	2,993	3,252	3,263	
	Electric	74RD54TT32EH	5,324	5,589	5,599	
60 x 60	Static	74RD60TT36	2,012	2,287	2,314	
	Nesting	74RD60TT36NE	3,028	3,299	3,324	
	Electric	74RD60TT36EH	7,621	7,896	7,923	

For VertiGo table options, please reference pages 166-167.

D-shaped with T-bases	Top Size	Base	Model Number	3P	3K	3W
 	24 x 36	Static	74D2436T22	\$ 771	\$ 860	\$ 929
		Nesting	74D2436T22NE	1,430	1,517	1,584
		Ratchet	74D2436T22RA	1,302	1,392	1,460
		Crank	74D2436T22CR	1,463	1,552	1,621
		Electric	74D2436T22EH	2,545	2,634	2,702
 	24 x 48	Static	74D2448T22	846	964	1,041
		Nesting	74D2448T22NE	1,502	1,620	1,693
		Ratchet	74D2448T22RA	1,377	1,496	1,571
		Crank	74D2448T22CR	1,538	1,657	1,733
		Count Bal	74D2448T22BL	2,606	2,725	2,801
		Electric	74D2448T22EH	2,618	2,738	2,813
  	24 x 60	Static	74D2460T22	920	1,069	1,152
		Nesting	74D2460T22NE	1,575	1,721	1,802
		Ratchet	74D2460T22RA	1,452	1,601	1,684
		Crank	74D2460T22CR	1,612	1,761	1,844
		Count Bal	74D2460T22BL	2,733	2,882	2,965
  	24 x 72	Static	74D2472T22	995	1,173	1,264
		Nesting	74D2472T22NE	1,689	1,864	1,952
		Ratchet	74D2472T22RA	1,526	1,705	1,795
		Crank	74D2472T22CR	1,687	1,865	1,956
		Count Bal	74D2472T22BL	2,810	2,989	3,079
		Electric	74D2472T22EH	2,767	2,946	3,036
  	24 x 84	Static	74D2484T22	1,153	1,361	1,459
		Nesting	74D2484T22NE	1,945	2,150	2,245
		Electric	74D2484T22EH	2,926	3,135	3,232
  	24 x 90	Static	74D2490T22	1,190	1,414	1,515
		Nesting	74D2490T22NE	1,982	2,200	2,300
		Electric	74D2490T22EH	2,964	3,186	3,288
  	24 x 96 *	Static	74D2496T22	1,228	1,466	1,570
		Nesting	74D2496T22NE	2,018	2,252	2,355
		Electric	74D2496T22EH	3,000	3,239	3,344
  	30 x 48	Static	74D3048T26	939	1,088	1,153
		Nesting	74D3048T26NE	1,594	1,740	1,803
		Ratchet	74D3048T26RA	1,472	1,621	1,686
		Crank	74D3048T26CR	1,630	1,778	1,843
		Count Bal	74D3048T26BL	2,696	2,845	2,910
		Electric	74D3048T26EH	2,712	2,861	2,926
  	30 x 60	Static	74D3060T26	1,033	1,218	1,286
		Nesting	74D3060T26NE	1,686	1,868	1,934
		Ratchet	74D3060T26RA	1,565	1,751	1,817
		Crank	74D3060T26CR	1,722	1,909	1,976
		Count Bal	74D3060T26BL	2,799	2,985	3,052
		Electric	74D3060T26EH	2,805	2,991	3,058



* \$200 NET surcharge per order for oversized pallet

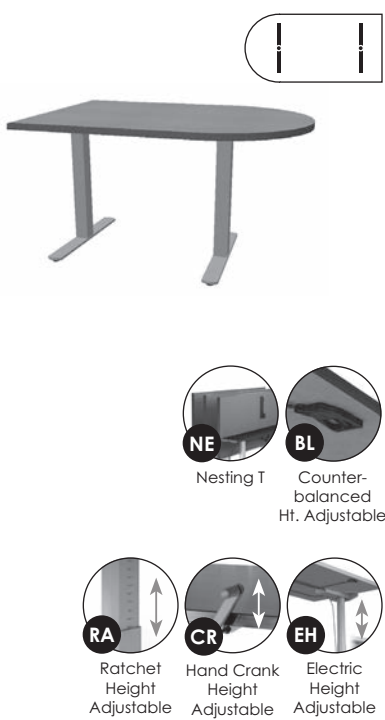

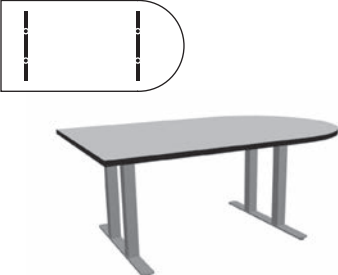

For VertiGo table options, please reference pages 166-167.

Top Size	Base	Model Number	3P	3K	3W	D-shaped with T-bases
30 x 72	Static	74D3072T26	\$ 1,125	\$ 1,349	\$ 1,417	
	Nesting	74D3072T26NE	1,817	2,035	2,103	
	Ratchet	74D3072T26RA	1,657	1,881	1,949	
	Crank	74D3072T26CR	1,816	2,039	2,108	
	Count Bal	74D3072T26BL	2,936	3,159	3,228	
	Electric	74D3072T26EH	2,898	3,121	3,189	
30 x 84	Static	74D3084T26	1,302	1,563	1,633	
	Nesting	74D3084T26NE	2,092	2,347	2,415	
	Electric	74D3084T26EH	3,075	3,336	3,406	
30 x 90	Static	74D3090T26	1,349	1,628	1,699	
	Nesting	74D3090T26NE-LT	2,411	N/A	N/A	
	Electric	74D3090T26EH	3,122	3,400	3,472	
30 x 96 *	Static	74D3096T26	1,396	1,693	1,766	
	Nesting	74D3096T26NE-LT	2,474	N/A	N/A	
	Electric	74D3096T26EH	3,168	3,465	3,538	
36 x 48	Static	74D3648T26	1,014	1,192	1,247	
	Nesting	74D3648T26NE	1,667	1,842	1,896	
	Ratchet	74D3648T26RA	1,546	1,725	1,779	
	Crank	74D3648T26CR	1,704	1,883	1,937	
	Count Bal	74D3648T26BL	2,770	2,949	3,003	
	Electric	74D3648T26EH	2,786	2,965	3,019	
36 x 60	Static	74D3660T26	1,125	1,349	1,399	
	Nesting	74D3660T26NE	1,862	2,082	2,131	
	Ratchet	74D3660T26RA	1,657	1,881	1,931	
	Crank	74D3660T26CR	1,816	2,039	2,089	
	Count Bal	74D3660T26BL	2,892	3,115	3,165	
	Electric	74D3660T26EH	2,898	3,121	3,171	
36 x 72	Static	74D3672T26	1,237	1,505	1,551	
	Nesting	74D3672T26NE	2,084	2,346	2,392	
	Ratchet	74D3672T26RA	1,769	2,037	2,084	
	Crank	74D3672T26CR	1,927	2,195	2,242	
	Count Bal	74D3672T26BL	3,048	3,315	3,381	
	Electric	74D3672T26EH	3,010	3,278	3,324	
36 x 84	Static	74D3684T26	1,433	1,746	1,788	
	Nest/Lightwt	74D3684T26NE-LT	2,526	N/A	N/A	
	Electric	74D3684T26EH	3,205	3,518	3,561	
36 x 90	Static	74D3690T26	1,488	1,823	1,864	
	Nest/Lightwt	74D3690T26NE-LT	2,602	N/A	N/A	
	Electric	74D3690T26EH	3,262	3,597	3,637	
36 x 96 *	Static	74D3696T26	1,544	1,902	1,941	
	Nest/Lightwt	74D3696T26NE-LT	2,679	N/A	N/A	
	Electric	74D3696T26EH	3,317	3,674	3,713	

* \$200 NET surcharge per order for oversized pallet

For VertiGo table options, please reference pages 166-167.



D-shaped with TT-bases	Top Size	Base	Model Number	3P	3K	3W
  Nesting TT  Electric Height Adjustable	42 x 60	Static	74D4260TT32	\$ 2,315	\$ 2,715	\$ 2,644
		Nesting	74D4260TT32NE	3,325	3,717	3,648
		Electric	74D4260TT32EH	5,663	6,063	5,992
	42 x 72	Static	74D4272TT32	2,315	2,715	2,674
		Nesting	74D4272TT32NE	3,325	3,717	3,677
		Electric	74D4272TT32EH	5,663	6,063	6,022
	42 x 84	Static	74D4284TT32	2,430	2,843	2,822
		Electric	74D4284TT32EH	5,778	6,190	6,170
	42 x 90	Static	74D4290TT32	2,505	2,947	2,918
		Electric	74D4290TT32EH	5,852	6,294	6,266
	42 x 96 *	Static	74D4296TT32	2,578	3,050	3,014
		Electric	74D4296TT32EH	5,926	6,397	6,361
48 x 60	Static	74D4860TT36	2,366	2,783	2,712	
	Nesting	74D4860TT32NE	3,375	3,784	3,714	
	Electric	74D4860TT36EH	7,975	8,392	8,321	
48 x 72	Static	74D4872TT36	2,366	2,783	2,741	
	Nesting	74D4872TT32NE	3,375	3,784	3,743	
	Electric	74D4872TT36EH	7,975	8,392	8,350	
48 x 84	Static	74D4884TT36	2,450	2,867	2,855	
	Electric	74D4884TT36EH	8,059	8,476	8,463	
48 x 90	Static	74D4890TT36	2,525	2,972	2,952	
	Electric	74D4890TT36EH	8,134	8,580	8,561	
48 x 96 *	Static	74D4896TT36	2,599	3,076	3,049	
	Electric	74D4896TT36EH	8,208	8,685	8,658	

Half Round with T-bases	Top Size	Base	Model Number	3P	3K	3W
  Counter-balanced Ht. Adjustable  Electric Height Adjustable  Ratchet Height Adjustable  Nesting TT	24 x 48	Static	74HR2448T18	\$ 830	\$ 951	\$ 1,013
		Nesting	74HR2448T18NE	1,487	1,606	1,666
		Ratchet	74HR2448T18RA	1,361	1,482	1,544
		Electric	74HR2448T18EH	2,607	2,726	2,788
	30 x 60	Static	74HR3060T22	1,015	1,202	1,252
		Nesting	74HR3060T22NE	1,668	1,852	1,901
		Ratchet	74HR3060T22RA	1,546	1,733	1,783
		Count Bal	74HR3060T22BL	2,827	3,014	3,064
		Electric	74HR3060T22EH	2,787	2,974	3,024
	36 x 72	Static	74HR3672T26	1,235	1,503	1,530
		Nesting	74HR3672T26NE	2,011	2,273	2,300
		Ratchet	74HR3672T26RA	1,768	2,035	2,063
Count Bal		74HR3672T26BL	3,047	3,313	3,342	
Electric		74HR3672T26EH	3,009	3,275	3,304	

* \$200 NET surcharge per order for oversized pallet

For VertiGo table options, please reference pages 166-167.

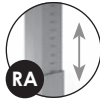
Top Size	Base	Model Number	3P	3K	3W	Trapezoid with T-bases
24 x 48	Static	74TZ2448T18	\$ 821	\$ 937	\$1,002	     
	Ratchet	74TZ2448T18RA	1,352	1,468	1,532	
	Crank	74TZ2448T18CR	1,516	1,632	1,697	
	Electric	74TZ2448T18EH	2,596	2,713	2,778	
24 x 72	Static	74TZ2472T18	1,010	1,202	1,286	
	Nesting	74TZ2472T18NE	1,663	1,852	1,934	
	Ratchet	74TZ2472T18RA	1,541	1,733	1,817	
	Crank	74TZ2472T18CR	1,705	1,897	1,981	
	Count Bal	74TZ2472T18BL	2,841	3,033	3,117	
	Electric	74TZ2472T18EH	2,785	2,977	3,061	
30 x 60	Static	74TZ3060T22	965	1,132	1,197	
	Nesting	74TZ3060T22NE	1,620	1,783	1,847	
	Ratchet	74TZ3060T22RA	1,497	1,664	1,729	
	Crank	74TZ3060T22CR	1,657	1,824	1,889	
	Count Bal	74TZ3060T22BL	2,781	2,948	3,013	
	Electric	74TZ3060T22EH	2,738	2,905	2,970	
36 x 72	Static	74TZ3672T26	1,209	1,466	1,502	
	Nesting	74TZ3672T26NE	1,985	2,237	2,272	
	Ratchet	74TZ3672T26RA	1,741	1,998	2,033	
	Crank	74TZ3672T26CR	1,900	2,156	2,192	
	Count Bal	74TZ3672T26BL	3,019	3,276	3,312	
	Electric	74TZ3672T26EH	2,981	3,239	3,274	

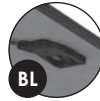
Top Size	Base	Model Number	3P	3K	3W	Squire with X-base
24 x 24	Static	74SL24X22	\$ 922	\$ 1,053	\$ 1,074	   
	Ratchet	74SL24X22RA	1,118	1,248	1,269	
	Short Bal	74SL24X22BLS	1,404	1,533	1,554	
30 x 30	Static	74SL30X26	998	1,150	1,184	
	Ratchet	74SL30X26RA	1,193	1,346	1,379	
	Short Bal	74SL30X26BLS	1,476	1,628	1,662	
36 x 36	Static	74SL36X32	1,079	1,256	1,300	
	Short Bal	74SL36X32BLS	1,556	1,733	1,777	
	Count Bal	74SL36X32BL	1,556	1,733	1,777	
42 x 42	Static	74SL42X36	1,166	1,371	1,424	
	Short Bal	74SL42X36BLS	1,640	1,844	1,898	
	Count Bal	74SL42X36BL	1,640	1,844	1,898	

For VertiGo table options, please reference pages 166-167.

tablex

99 surge
price list
Effective May 16, 2022

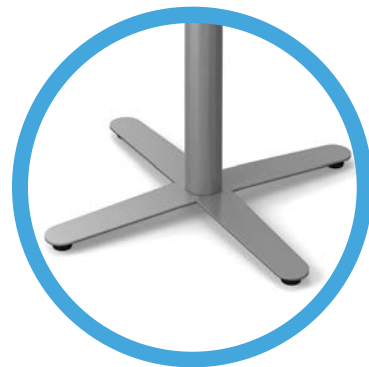



Surge series tables are sleek, stylish, and versatile. With height adjustable options and a variety of top shapes and sizes, Surge provides a sophisticated solution for any space.

Surge Base Styles

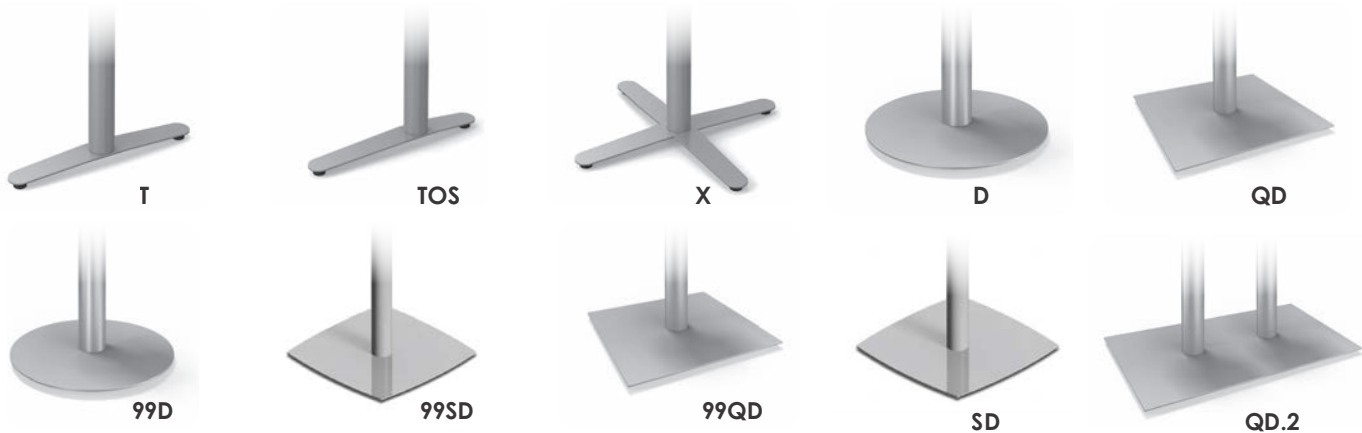

Surge Options

Standard Glides



Locking Casters



- LC Locking Casters**
can be added to any table for \$105 per set of four.
- FD Folding Bases**
priced accordingly with standard glides.
- NE Nesting Tables**
priced accordingly with locking casters.
- FT Flip Tops**
available on disc and X-based tables for \$131. Not available on counterbalanced tables.

- OS Offset T-bases**
available for \$37 per table.
- CH Chrome Finish**
is not available on Surge tables.
- WM Wire Management**
Built-in wire management is not available on Surge tables.
- WMLC Wire Management Leg Covers**
snap onto any round column and are \$47 each for 2" and \$75 each for 3".

- SH Special Height**
can be added to any table:
+ \$68 per column for heights > 29"
+ \$37 per column for heights < 29"
Special height tables with tops larger than 36x72" must be custom quoted.
- FR Footring**
is not available on Surge tables.
- PB Powerbox Mounting Plate**
is available on disc and X-bases for \$95.

Surge Height Adjustable Options

EH Electric Height is available on T-bases and is available in two finishes:

- 37 Satin Silver
- 57 Jet

BL Counterbalanced and Short Balanced are available on disc and X-bases. Available height adjustable finishes can be found on page 9.

Surge Top Shapes



Rectangle
p.190



Boat
p.193



Racetrack
p.194

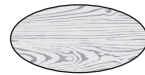

Elliptical
p.195



Squircle
p.196



Square
p.196



Round
p.197



D-shaped
p.198



Half Round
p.200



Trapezoid
p.200

Surge Top Options

QG Quick-Connect Ganging Brackets can be added to most table shapes for \$42 (includes 4 connectors per table).

GN Ganging Plates & Knobs can be added to most table shapes for \$42 (includes 2 plates and 8 knobs per table).

LT Lightweight Tops can be added to any square or rectangular table for \$121.

GR Grommets can be added to any table for \$42 each. To see specific locations, see page 217.

RC 3" Radius Corners can be added to any table for \$58.

Surge Edge Options

(corresponds with 3 columns of pricing)

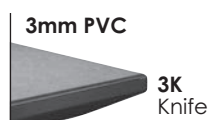
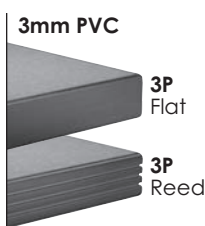

Electric Height Adjustable T-bases

Electric height adjustability gives you the ability to go from sitting to standing height at the push of a button. With a weight capacity of 225 lbs. per table, Surge is strong enough to work in many different applications.

The standard memory keypad will remember your four favorite heights.

Want to use Surge on the go? Simply add 2" to each vertical measurement to account for locking casters.

To specify:
All available electric models are priced in the following pages. They are denoted by the "EH" at the end of the model number.

Example:
99TC2460T22EH-3P
24x60" **electric height** table

\$2,308 List Price

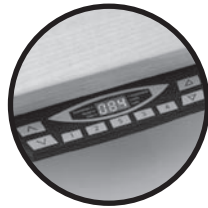

Standard
Memory
Keypad

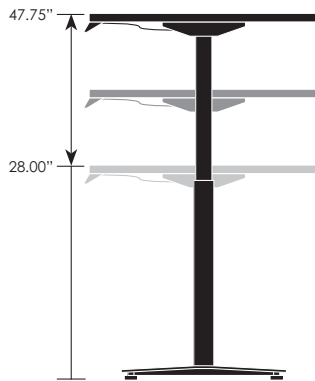

T-bases

Counterbalanced & Short Balanced Height Adjustable Disc & X-bases

Counterbalanced tables go from seated-to-standing height, while the short balanced goes from coffee-to-seated height. Available on tables using single column disc or X-bases, these tables are easy to adjust. Simply squeeze the small handle underneath and gently move the top to your desired height. It's that easy.

Want to use Surge on the go? Simply add 2" to each vertical measurement to account for the added height of locking casters.

To specify:

All available counterbalanced models are priced in the following pages. They are denoted by the "BL" or "BLS" (for short balanced) at the end of the model number.

Example:

99RD36X30BL-3P
36" round **counterbalanced** table
\$1,735 List Price

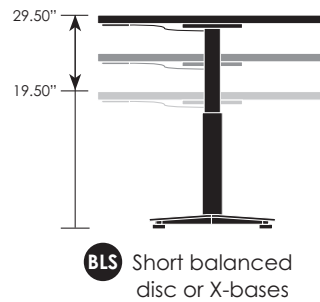
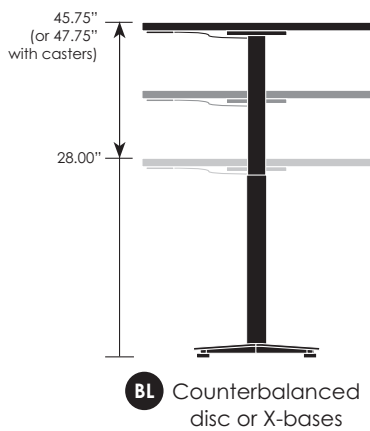
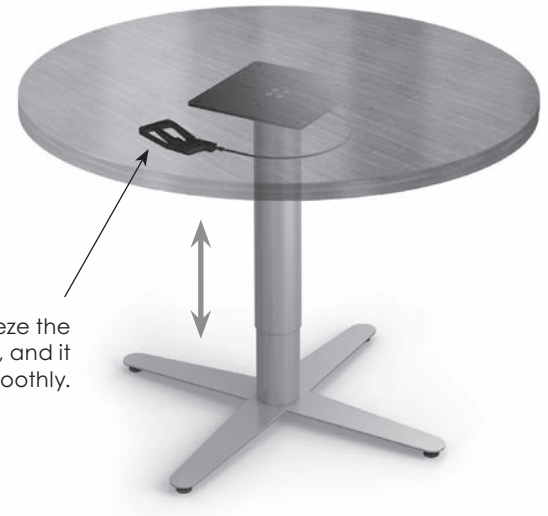

Counterbalanced Height Ranges:

Smaller Surge tables using smaller bases have a 17.75" range, while the larger tables using larger bases have an extended range of 19.75". See the list below for ranges of used on specific top shapes and sizes. All counterbalanced tables have a starting height of 28".

Square	Range	Max Ht.	Round	Range	Max Ht.
36" SQ 42" SQ	19.75"	47.75"	36" RD-X 36" BU	17.75"	45.75"
			36" RD-D 42" RD 48" RD	19.75"	47.75"

Rectangular with T-bases	Top Size	Base	Model Number	3P	3K	3W
    <p>FD Folding T NE Nesting T EH Electric Height Adjustable</p>	24 x 36	Static	99TC2436T22	\$ 749	\$ 817	\$ 914
		Nesting	99TC2436T22NE	1,407	1,474	1,569
		Electric	99TC2436T22EH	2,344	2,411	2,509
	24 x 48	Static	99TC2448T22	804	894	1,004
		Folding	99TC2448T22FD	1,117	1,206	1,317
		Nesting	99TC2448T22NE	1,461	1,549	1,657
		Electric	99TC2448T22EH	2,399	2,488	2,599
	24 x 60	Static	99TC2460T22	829	929	1,062
		Folding	99TC2460T22FD	1,154	1,254	1,386
		Nesting	99TC2460T22NE	1,486	1,584	1,714
		Electric	99TC2460T22EH	2,424	2,524	2,656
	24 x 72	Static	99TC2472T22	876	995	1,143
Folding		99TC2472T22FD	1,202	1,320	1,468	
Nesting		99TC2472T22NE	1,756	1,873	2,018	
Electric		99TC2472T22EH	2,471	2,590	2,738	
24 x 84	Static	99TC2484T22	1,053	1,207	1,358	
	Folding	99TC2484T22FD	1,293	1,448	1,599	
	Nesting	99TC2484T22NE	1,846	1,999	2,146	
24 x 90	Static	99TC2490T22	1,107	1,284	1,433	
	Folding	99TC2490T22FD	1,349	1,525	1,674	
	Nesting	99TC2490T22NE	1,900	2,073	2,219	
24 x 96 *	Static	99TC2496T22	1,107	1,284	1,447	
	Folding	99TC2496T22FD	1,349	1,525	1,689	
	Nesting	99TC2496T22NE	1,900	2,073	2,234	
30 x 36	Static	99TC3036T26	797	881	981	
	Nesting	99TC3036T26NE	1,456	1,538	1,635	
	Electric	99TC3036T26EH	2,394	2,477	2,578	
30 x 48	Static	99TC3048T26	866	976	1,086	
	Folding	99TC3048T26FD	1,179	1,289	1,398	
	Nesting	99TC3048T26NE	1,522	1,630	1,737	
	Electric	99TC3048T26EH	2,462	2,573	2,682	
30 x 60	Static	99TC3060T26	887	1,006	1,139	
	Folding	99TC3060T26FD	1,212	1,331	1,464	
	Nesting	99TC3060T26NE	1,542	1,659	1,790	
	Electric	99TC3060T26EH	2,483	2,602	2,735	
30 x 72	Static	99TC3072T26	939	1,080	1,227	
	Folding	99TC3072T26FD	1,265	1,405	1,551	
	Nesting	99TC3072T26NE	1,818	1,956	2,099	
	Electric	99TC3072T26EH	2,536	2,676	2,823	

* \$200 NET surcharge per order for oversized pallet

For Surge table options, please reference pages 186-189.

Top Size	Base	Model Number	3P	3K	3W	Rectangular with T-bases
30 x 84	Static	99TC3084T26	\$ 1,152	\$ 1,344	\$ 1,482	
	Folding	99TC3084T26FD	1,394	1,586	1,724	
	Nesting	99TC3084T26NE	1,944	2,133	2,267	
30 x 90	Static	99TC3090T26	1,221	1,440	1,571	
	Folding	99TC3090T26FD	1,462	1,682	1,813	
	Nesting-Light	99TC3090T26NE-LT	2,226	N/A	2,592	
30 x 96 *	Static	99TC3096T26	1,221	1,440	1,586	
	Folding	99TC3096T26FD	1,462	1,682	1,827	
	Nesting-Light	99TC3096T26NE-LT	2,226	N/A	2,607	
36 x 48	Static	99TC3648T26	919	1,052	1,160	
	Folding	99TC3648T26FD	1,231	1,363	1,472	
	Nesting	99TC3648T26NE	1,700	1,830	1,936	
	Electric	99TC3648T26EH	2,515	2,648	2,756	
36 x 60	Static	99TC3660T26	1,000	1,164	1,278	
	Folding	99TC3660T26FD	1,326	1,489	1,603	
	Nesting	99TC3660T26NE	1,852	2,012	2,124	
	Electric	99TC3660T26EH	2,596	2,761	2,874	
36 x 72	Static	99TC3672T26	1,050	1,235	1,363	
	Folding	99TC3672T26FD	1,376	1,561	1,689	
	Nesting	99TC3672T26NE	1,927	2,109	2,234	
	Electric	99TC3672T26EH	2,646	2,832	2,959	
36 x 84	Static	99TC3684T26	1,246	1,475	1,599	
	Folding	99TC3684T26FD	1,486	1,716	1,840	
	Nesting-Light	99TC3684T26NE-LT	2,260	N/A	2,630	
36 x 90	Static	99TC3690T26	1,326	1,586	1,701	
	Folding	99TC3690T26FD	1,566	1,827	1,943	
	Nesting-Light	99TC3690T26NE-LT	2,370	N/A	2,764	
36 x 96 *	Static	99TC3696T26	1,326	1,586	1,716	
	Folding	99TC3696T26FD	1,566	1,827	1,958	
	Nesting-Light	99TC3696T26NE-LT	2,370	N/A	2,779	

* \$200 NET surcharge per order for oversized pallet

For Surge table options, please reference pages 186-189.

Rectangular with 2 Thin Disc Bases	Top Size	Base	Model Number	3P	3K	3W
	24 x 60	Static	99TC2460D20	\$ 1,406	\$ 1,505	\$ 1,638
	24 x 72	Static	99TC2472D20	1,454	1,571	1,719
	24 x 84	Static	99TC2484D20	1,545	1,699	1,851
	24 x 90	Static	99TC2490D20	1,684	1,860	2,009
	24 x 96 *	Static	99TC2496D20	1,684	1,860	2,024
	30 x 60	Static	99TC3060D20	1,456	1,574	1,707
	30 x 72	Static	99TC3072D20	1,508	1,649	1,795
	30 x 84	Static	99TC3084D20	1,637	1,830	1,967
	30 x 90	Static	99TC3090D20	1,790	2,008	2,140
	30 x 96 *	Static	99TC3096D20	1,790	2,008	2,155
	36 x 72	Static	99TC3672D24	1,696	1,882	2,009
	36 x 84	Static	99TC3684D24	1,808	2,036	2,160
	36 x 90	Static	99TC3690D24	1,971	2,233	2,347
	36 x 96 *	Static	99TC3696D24	1,971	2,233	2,362
	42 x 72	Static	99TC4272D32	2,068	2,299	2,407
	42 x 84	Static	99TC4284D32	2,159	2,428	2,537
	42 x 90	Static	99TC4290D32	2,334	2,637	2,735
	42 x 96 *	Static	99TC4296D32	2,334	2,637	2,749

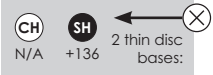

Rectangle with 2-column Disc Base	Top Size	Base	Model Number	3P	3K	3W
	24 x 36	Static	99TC2436QD2032.2	\$ 1,322	\$ 1,390	\$ 1,487
	24 x 48	Static	99TC2448QD2032.2	1,377	1,466	1,577
	30 x 36	Static	99TC3036QD2032.2	1,362	1,446	1,546
	30 x 48	Static	99TC3048QD2032.2	1,431	1,541	1,650
	36 x 48	Static	99TC3648QD2032.2	1,484	1,615	1,724

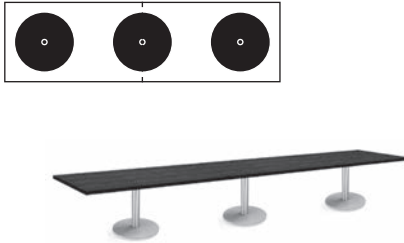
Rectangular with 3 Thin Disc Bases	Top Size	Base	Model Number	3P	3K	3W
	42 x 120	Static	99TC42120D32(3)-TJ	\$ 3,415	\$ 3,867	\$ 3,927
	42 x 144	Static	99TC42144D32(3)-TJ	3,600	4,125	4,190



* \$200 NET surcharge per order for oversized pallet

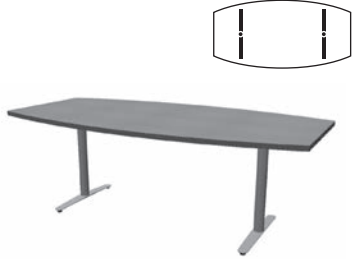

For Surge table options, please reference pages 186-189.

Top Size	Base	Model Number	3P	3K	3W	Boat-shaped with T-bases
30 x 42 x 84	Static	99BT3084T26	\$ 1,582	\$ 1,946	\$ 1,940	
30 x 42 x 90	Static	99BT3090T26	1,711	2,127	2,096	
30 x 42 x 96 *	Static	99BT3096T26	1,711	2,127	2,111	

Top Size	Base	Model Number	3P	3K	3W	Boat-shaped with 2 Thin Disc Bases
30 x 42 x 84	Static	99BT3084D24	\$ 2,144	\$ 2,508	\$ 2,502	
30 x 42 x 90	Static	99BT3090D24	2,357	2,772	2,742	
30 x 42 x 96 *	Static	99BT3096D24	2,357	2,772	2,757	
36 x 48 x 84	Static	99BT3684D32	2,527	2,942	2,906	
36 x 48 x 90	Static	99BT3690D32	2,758	3,231	3,166	
36 x 48 x 96 *	Static	99BT3696D32	2,758	3,231	3,181	

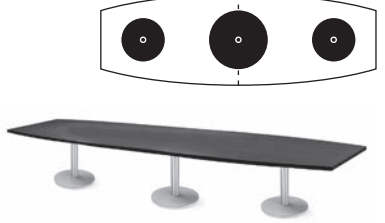
 →
  
 2 thin disc bases: N/A +136





Top Size	Base	Model Number	3P	3K	3W	Boat-shaped with 3 Thin Disc Bases
36 x 48 x 120	Static	99BT36120D243224-TJ	\$3,692	\$4,357	\$4,223	
36 x 48 x 144	Static	99BT36144D243224-TJ	3,986	4,767	4,605	

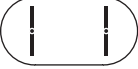

  ← 
 3 thin disc bases: N/A +204

surge 



* \$200 NET surcharge per order for oversized pallet

For Surge table options, please reference pages 186-189.

Racetrack with T-bases	Top Size	Base	Model Number	3P	3K	3W
  <div style="display: flex; justify-content: space-around; margin-top: 10px;"> <div style="text-align: center;">  <p>FD Folding T</p> </div> <div style="text-align: center;">  <p>NE Nesting T</p> </div> <div style="text-align: center;">  <p>EH Electric Height Adjustable</p> </div> </div>	36 x 60	Static	99RT3660T26	\$ 1,259	\$ 1,528	\$ 1,526
		Nesting	99RT3660T26NE	2,034	2,298	2,296
		Electric	99RT3660T26EH	2,847	3,115	3,113
	36 x 72	Static	99RT3672T26	1,259	1,528	1,556
		Folding	99RT3672T26FD	1,585	1,854	1,881
		Nesting	99RT3672T26NE	2,107	2,369	2,397
		Electric	99RT3672T26EH	2,847	3,115	3,142
	36 x 84	Static	99RT3684T26	1,579	1,942	1,927
		Folding	99RT3684T26FD	1,820	2,182	2,169
36 x 90	Static	99RT3690T26	1,711	2,127	2,088	
	Folding	99RT3690T26FD	1,952	2,367	2,329	
36 x 96 *	Static	99RT3696T26	1,711	2,127	2,103	
	Folding	99RT3696T26FD	1,952	2,367	2,344	

Racetrack with 2 Thin Disc Bases	Top Size	Base	Model Number	3P	3K	3W
 	36 x 72	Static	99RT3672D20	\$ 1,829	\$ 2,097	\$ 2,125
	36 x 84	Static	99RT3684D20	2,064	2,426	2,412
	36 x 90	Static	99RT3690D20	2,280	2,695	2,656
	36 x 96 *	Static	99RT3696D20	2,280	2,695	2,672
	42 x 84	Static	99RT4284D24	2,141	2,504	2,498
	42 x 90	Static	99RT4290D24	2,357	2,772	2,742
	42 x 96 *	Static	99RT4296D24	2,357	2,772	2,757
	48 x 84	Static	99RT4884D32	2,674	3,147	3,066
	48 x 90	Static	99RT4890D32	2,758	3,231	3,165
	48 x 96 *	Static	99RT4896D32	2,758	3,231	3,180

CH N/A
 SH +136
 ← X 2 thin disc bases:

Racetrack with 3 Thin Disc Bases	Top Size	Base	Model Number	3P	3K	3W
 	42 x 120	Static	99RT42120D24(3)	\$ 3,548	\$ 4,207	\$ 4,068
	42 x 144	Static	99RT42144D24(3)	3,839	4,613	4,447
	48 x 120	Static	99RT48120D32(3)	3,948	4,612	4,478
	48 x 144	Static	99RT48144D32(3)	4,241	5,024	4,860

CH N/A
 SH +204
 ← X 3 thin disc bases:

* \$200 NET surcharge per order for oversized pallet

For Surge table options, please reference pages 186-189.

Top Size	Base	Model Number	3P	3K	3W	Elliptical with T-bases
30 x 54	Static	99EL3054T22	\$1,004	\$1,174	\$1,210	
	Electric	99EL3054T22EH	2,599	2,769	2,805	
30 x 60	Static	99EL3060T22	1,049	1,237	1,271	
	Electric	99EL3060T22EH	2,644	2,831	2,865	
36 x 60	Static	99EL3660T26	1,152	1,377	1,395	
	Electric	99EL3660T26EH	2,748	2,974	2,991	
36 x 72	Static	99EL3672T26	1,259	1,528	1,537	
	Electric	99EL3672T26EH	2,856	3,124	3,133	
36 x 84	Static	99EL3684T26	1,457	1,771	1,768	
36 x 90	Static	99EL3690T26	1,565	1,921	1,898	
36 x 96 *	Static	99EL3696T26	1,565	1,921	1,909	



Top Size	Base	Model Number	3P	3K	3W	Elliptical with 2 Thin Disc Bases
36 x 72	Static	99EL3672D20	\$1,829	\$2,097	\$2,105	
36 x 84	Static	99EL3684D20	1,941	2,255	2,253	
36 x 90	Static	99EL3690D20	2,133	2,490	2,467	
36 x 96 *	Static	99EL3696D20	2,133	2,490	2,478	
42 x 72	Static	99EL4272D24	2,019	2,333	2,318	
42 x 84	Static	99EL4284D24	2,141	2,504	2,475	
42 x 90	Static	99EL4290D24	2,360	2,776	2,719	
42 x 96 *	Static	99EL4296D24	2,360	2,776	2,730	
48 x 84	Static	99EL4884D32	2,674	3,148	3,049	
48 x 90	Static	99EL4890D32	2,759	3,232	3,144	
48 x 96 *	Static	99EL4896D32	2,759	3,232	3,156	



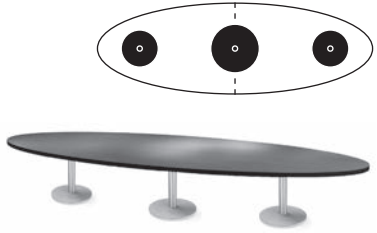







Top Size	Base	Model Number	3P	3K	3W	Elliptical with 3 Thin Disc Bases
42 x 120	Static	99EL42120D24(3)	\$3,548	\$4,207	\$4,027	
42 x 144	Static	99EL42144D24(3)	3,839	4,613	4,394	
48 x 120	Static	99EL48120D32(3)	3,948	4,612	4,440	
48 x 144	Static	99EL48144D32(3)	4,241	5,024	4,809	





* \$200 NET surcharge per order for oversized pallet





For Surge table options, please reference pages 186-189.



Squiracle with X-base	Top Size	Base	Model Number	3P	3K	3W
  Short Balanced Ht. Adjustable  Counter-balanced Ht. Adjustable	24 x 24	Static	99SL24X22	\$ 810	\$ 940	\$ 961
		Short Bal	99SL24X22BLS	1,396	1,526	1,547
	30 x 30	Static	99SL30X26	870	1,022	1,056
		Short Bal	99SL30X26BLS	1,460	1,612	1,647
	36 x 36	Static	99SL36X30	1,021	1,199	1,243
		Short Bal	99SL36X30BLS	1,942	2,119	2,165
		Count Bal	99SL36X30BL	1,942	2,119	2,165
	42 x 42	Static	99SL42X30	1,089	1,294	1,348
		Short Bal	99SL42X30BLS	2,011	2,216	2,270
		Count Bal	99SL42X30BL	2,011	2,216	2,270





Squiracle with Thin Squiracle Disc Base	Top Size	Base	Model Number	3P	3K	3W
  Short Balanced Ht. Adjustable  Counter-balanced Ht. Adjustable  N/A  +68  N/A Thin disc bases:	24 x 24	Static	99SL24SD16	\$ 937	\$ 1,067	\$ 1,088
		Short Bal	99SL24SD16BLS	1,580	1,710	1,731
	30 x 30	Static	99SL30SD16	993	1,146	1,180
		Short Bal	99SL30SD16BLS	1,636	1,789	1,822
	36 x 36	Static	99SL36SD20	1,092	1,269	1,314
		Short Bal	99SL36SD20BLS	1,738	1,916	1,960
		Count Bal	99SL36SD20BL	1,738	1,916	1,960
	42 x 42	Static	99SL42SD26	1,305	1,509	1,563
		Short Bal	99SL42SD26BLS	1,927	2,132	2,186
		Count Bal	99SL42SD26BL	1,927	2,132	2,186

Square with X-base	Top Size	Base	Model Number	3P	3K	3W
  Short Balanced Ht. Adjustable  Counter-balanced Ht. Adjustable	24 x 24	Static	99SQ2424X22	\$ 600	\$ 645	\$ 729
		Short Bal	99SQ2424X22BLS	1,186	1,231	1,315
	30 x 30	Static	99SQ3030X26	664	734	830
		Short Bal	99SQ3030X26BLS	1,255	1,325	1,420
	36 x 36	Static	99SQ3636X30	827	927	1,029
		Short Bal	99SQ3636X30BLS	1,749	1,848	1,951
		Count Bal	99SQ3636X30BL	1,749	1,848	1,951
	42 x 42	Static	99SQ4242X34	935	1,069	1,176
		Short Bal	99SQ4242X34BLS	1,857	1,991	2,097
		Count Bal	99SQ4242X34BL	1,857	1,991	2,097

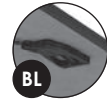

For Surge table options, please reference pages 186-189.

Top Size	Base	Model Number	3P	3K	3W	Square with Thin Square Disc Base
24 x 24	Static	99SQ2424QD16	\$ 724	\$ 770	\$ 854	    <p>Short Balanced Ht. Adjustable</p> <p>Counter-balanced Ht. Adjustable</p> <p>Thin disc bases: CH N/A SH +68 NU N/A</p>
	Short Bal	99SQ2424QD16BLS	1,370	1,415	1,499	
30 x 30	Static	99SQ3030QD16	786	855	951	
	Short Bal	99SQ3030QD16BLS	1,431	1,501	1,596	
36 x 36	Static	99SQ3636QD20	898	998	1,101	
	Short Bal	99SQ3636QD20BLS	1,544	1,645	1,747	
	Count Bal	99SQ3636QD20BL	1,544	1,645	1,747	
42 x 42	Static	99SQ4242QD26	1,113	1,248	1,354	
	Short Bal	99SQ4242QD26BLS	1,752	1,887	1,993	
	Count Bal	99SQ4242QD26BL	1,752	1,887	1,993	

Top Size	Base	Model Number	3P	3K	3W	Round with X-base
24 x 24	Static	99RD24X22	\$ 638	\$ 699	\$ 746	    <p>Short Balanced Ht. Adjustable</p> <p>Counter-balanced Ht. Adjustable</p>
	Short Bal	99RD24X22BLS	1,224	1,285	1,332	
30 x 30	Static	99RD30X26	724	818	864	
	Short Bal	99RD30X26BLS	1,314	1,409	1,455	
36 x 36	Static	99RD36X30	900	1,029	1,073	
	Short Bal	99RD36X30BLS	1,822	1,951	1,993	
	Count Bal	99RD36X30BL	1,822	1,951	1,993	
42 x 42	Static	99RD42X30	1,017	1,192	1,224	
	Short Bal	99RD42X30BLS	1,938	2,114	2,145	
	Count Bal	99RD42X30BL	1,938	2,114	2,145	
48 x 48	Static	99RD48X34	1,069	1,258	1,302	
	Short Bal	99RD48X34BLS	1,991	2,180	2,224	
	Count Bal	99RD48X34BL	1,991	2,180	2,224	

Top Size	Base	Model Number	3P	3K	3W	Round with thin Disc Base
24 x 24	Static	99RD24D20	\$ 762	\$ 823	\$ 870	    <p>Short Balanced Ht. Adjustable</p> <p>Counter-balanced Ht. Adjustable</p> <p>Thin disc bases: CH N/A SH +68 NU N/A</p>
	Short Bal	99RD24D20BLS	1,350	1,411	1,458	
30 x 30	Static	99RD30D20	845	939	985	
	Short Bal	99RD30D20BLS	1,434	1,527	1,573	
36 x 36	Static	99RD36D20	933	1,062	1,105	
	Short Bal	99RD36D20BLS	1,521	1,650	1,693	
	Count Bal	99RD36D20BL	1,521	1,650	1,693	
42 x 42	Static	99RD42D24	1,087	1,264	1,294	
	Short Bal	99RD42D24BLS	1,977	2,152	2,183	
	Count Bal	99RD42D24BL	1,977	2,152	2,183	
48 x 48	Static	99RD48D32	1,248	1,437	1,481	
	Short Bal	99RD48D32BLS	2,131	2,319	2,364	
	Count Bal	99RD48D32BL	2,131	2,319	2,364	

For Surge table options, please reference pages 186-189.

D-shaped with T-bases	Top Size	Base	Model Number	3P	3K	3W
 	24 x 36	Static	99D2436T22	\$ 804	\$ 893	\$ 961
		Nesting	99D2436T22NE	1,461	1,549	1,615
		Electric	99D2436T22EH	2,399	2,488	2,556
	24 x 48	Static	99D2448T22	878	997	1,073
		Nesting	99D2448T22NE	1,535	1,651	1,726
		Electric	99D2448T22EH	2,473	2,592	2,667
	24 x 60	Static	99D2460T22	953	1,102	1,185
		Nesting	99D2460T22NE	1,607	1,753	1,835
		Electric	99D2460T22EH	2,548	2,696	2,779
24 x 72	Static	99D2472T22	1,027	1,206	1,296	
	Nesting	99D2472T22NE	1,720	1,896	1,984	
	Electric	99D2472T22EH	2,621	2,800	2,890	
24 x 84	Static	99D2484T22	1,186	1,394	1,491	
	Nesting	99D2484T22NE	1,977	2,181	2,277	
24 x 90	Static	99D2490T22	1,223	1,446	1,547	
	Nesting	99D2490T22NE	2,013	2,232	2,331	
24 x 96 *	Static	99D2496T22	1,260	1,498	1,603	
	Nesting	99D2496T22NE	2,050	2,283	2,386	
30 x 48	Static	99D3048T26	960	1,109	1,174	
	Nesting	99D3048T26NE	1,615	1,761	1,824	
	Electric	99D3048T26EH	2,557	2,705	2,770	
30 x 60	Static	99D3060T26	1,054	1,239	1,307	
	Nesting	99D3060T26NE	1,707	1,888	1,955	
	Electric	99D3060T26EH	2,650	2,837	2,903	
30 x 72	Static	99D3072T26	1,147	1,370	1,438	
	Nesting	99D3072T26NE	1,838	2,056	2,124	
	Electric	99D3072T26EH	2,743	2,966	3,035	
30 x 84	Static	99D3084T26	1,323	1,585	1,654	
	Nesting	99D3084T26NE	2,112	2,368	2,436	
30 x 90	Static	99D3090T26	1,371	1,649	1,720	
	Nesting	99D3090T26NE	2,431	N/A	N/A	
30 x 96 *	Static	99D3096T26	1,417	1,714	1,787	
	Nesting	99D3096T26NE	2,495	N/A	N/A	
36 x 48	Static	99D3648T26	1,035	1,213	1,268	
	Nesting	99D3648T26NE	1,688	1,863	1,917	
	Electric	99D3648T26EH	2,631	2,810	2,864	
36 x 60	Static	99D3660T26	1,147	1,370	1,420	
	Nesting	99D3660T26NE	1,883	2,102	2,152	
	Electric	99D3660T26EH	2,743	2,966	3,016	
36 x 72	Static	99D3672T26	1,258	1,526	1,572	
	Nesting	99D3672T26NE	2,105	2,367	2,413	
	Electric	99D3672T26EH	2,854	3,122	3,169	

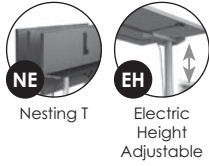

surge

* \$200 NET surcharge per order for oversized pallet

For Surge table options, please reference pages 186-189.

Top Size	Base	Model Number	3P	3K	3W	D-shaped with T-bases
36 x 84	Static	99D3684T26	\$1,454	\$1,767	\$1,810	
	Nesting	99D3684T26NE-LT	2,547	N/A	N/A	
36 x 90	Static	99D3690T26	1,510	1,845	1,885	
	Nesting	99D3690T26NE-LT	2,623	N/A	N/A	
36 x 96 *	Static	99D3696T26	1,566	1,923	1,962	
	Nesting	99D3696T26NE-LT	2,700	N/A	N/A	

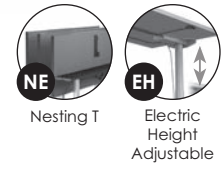

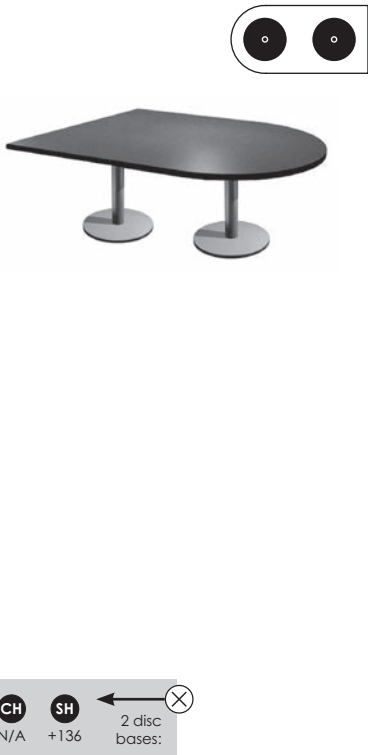
Top Size	Base	Model Number	3P	3K	3W	D-shaped with 2 Disc Bases
24 x 60	Static	99D2460D20	\$1,529	\$1,678	\$1,761	
24 x 72	Static	99D2472D20	1,604	1,782	1,873	
24 x 84	Static	99D2484D20	1,762	1,970	2,068	
24 x 90	Static	99D2490D20	1,799	2,023	2,124	
24 x 96 *	Static	99D2496D20	1,837	2,075	2,179	
30 x 60	Static	99D3060D20	1,623	1,809	1,875	
30 x 72	Static	99D3072D20	1,715	1,939	2,007	
30 x 84	Static	99D3084D20	1,893	2,153	2,223	
30 x 90	Static	99D3090D20	1,939	2,218	2,289	
30 x 96 *	Static	99D3096D20	1,985	2,283	2,355	
36 x 72	Static	99D3672D24	1,904	2,172	2,219	
36 x 84	Static	99D3684D24	2,100	2,412	2,455	
36 x 90	Static	99D3690D24	2,156	2,491	2,532	
36 x 96 *	Static	99D3696D24	2,212	2,569	2,608	
42 x 72	Static	99D4272D32	2,490	2,890	2,849	
42 x 84	Static	99D4284D32	2,606	3,017	2,997	
42 x 90	Static	99D4290D32	2,679	3,121	3,093	
42 x 96 *	Static	99D4296D32	2,753	3,224	3,189	



* \$200 NET surcharge per order for oversized pallet

For Surge table options, please reference pages 186-189.

Half Round with T-bases	Top Size	Base	Model Number	3P	3K	3W
	30 x 60	Static	99HR3060T22	\$ 1,047	\$ 1,234	\$ 1,285
		Nesting	99HR3060T22NE	1,700	1,883	1,932
		Electric	99HR3060T22EH	2,642	2,829	2,879
	36 x 72	Static	99HR3672T26	1,257	1,524	1,552
		Nesting	99HR3672T26NE	2,031	2,294	2,321
		Electric	99HR3672T26EH	2,853	3,120	3,148

Trapezoid with T-bases	Top Size	Base	Model Number	3P	3K	3W
	30 x 60	Static	99TZ3060T22	\$ 998	\$ 1,165	\$ 1,230
		Nesting	99TZ3060T22NE	1,651	1,815	1,879
		Electric	99TZ3060T22EH	2,593	2,760	2,825
	36 x 72	Static	99TZ3672T26	1,230	1,487	1,523
		Nesting	99TZ3672T26NE	2,006	2,257	2,293
		Electric	99TZ3672T26EH	2,817	3,074	3,110



For Surge table options, please reference pages 186-189.

For Surge table options, please reference pages 186-189.

tablex

AC accessories
price list
Effective May 16, 2022

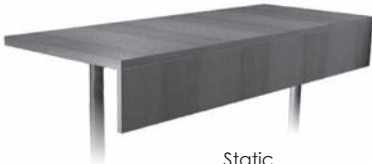

Laminate Modesty Panels	Top Size	Base	Model Number	Hardware	3P	3W
	10 x 36	Static	MP1036	02 Black	\$ 138	\$ 261
		Nesting	MP1036NE	02 Black	228	350
 Static	10 x 48	Static	MP1048	02 Black	165	320
		Nesting	MP1048NE	02 Black	255	409
	10 x 60	Static	MP1060	02 Black	192	378
Folding		MP1060FD	02 Black	351	538	
Nesting		MP1060NE	02 Black	282	469	
 Folding	10 x 72	Static	MP1072	02 Black	234	452
		Folding	MP1072FD	02 Black	377	597
	Nesting	MP1072NE	02 Black	308	528	
 Nesting	10 x 84	Static	MP1084	02 Black	260	512
		Folding	MP1084FD	02 Black	498	750
	Nesting	MP1084NE	02 Black	394	646	
10 x 90	Static	MP1090	02 Black	301	571	
	Folding	MP1090FD	02 Black	525	794	
	Nesting	MP1090NE	02 Black	422	690	
10 x 96 *	Static	MP1096	02 Black	301	585	
	Folding	MP1096FD	02 Black	525	809	
	Nesting	MP1096NE	02 Black	422	705	

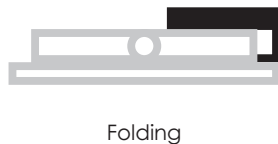

accessories

* \$200 NET surcharge per order for oversized pallet

Top Size	Base	Model Number	Hardware		Price	Frosted Acrylic Modesty Panels
10 x 36	Static or Nesting	MAP1036	-BL	-SV	\$ 370	
10 x 48	Static or Nesting	MAP1048	-BL	-SV	412	
10 x 60	Static or Nesting	MAP1060	-BL	-SV	455	
10 x 66	Static or Nesting	MAP1066	-BL	-SV	476	
10 x 72	Static or Nesting	MAP1072	-BL	-SV	497	
10 x 84	Static or Nesting	MAP1084	-BL	-SV	645	
10 x 90	Static or Nesting	MAP1090	-BL	-SV	687	
10 x 96 *	Static or Nesting	MAP1096	-BL	-SV	687	

Top Size	Basez	Model Number	Finish	Price	Perforated Metal Modesty Panels
9 x 48	Static or Nesting	MMP948	Powdercoated	\$ 489	
9 x 60	Static or Nesting	MMP960	Powdercoated	518	
9 x 72	Static or Nesting	MMP972	Powdercoated	546	

Top Size	Base	Model Number	Color	Price	Mesh Modesty Panels
10 x 36	Static or Nesting	MSP1036	Black mesh	\$ 251	
10 x 48	Static or Nesting	MSP1048	Black mesh	263	
10 x 60	Static or Nesting	MSP1060	Black mesh	278	
10 x 72	Static or Nesting	MSP1072	Black mesh	290	
10 x 84	Static or Nesting	MSP1084	Black mesh	305	
10 x 90	Static or Nesting	MSP1090	Black mesh	309	
10 x 96 *	Static or Nesting	MSP1096	Black mesh	315	

* \$200 NET surcharge per order for oversized pallet

Laminate Privacy Panels	Top Size	Base	Model Number	Hardware	3P	3W
	10 x 36	Static	PP1036	Silver	\$ 220	\$ 343
	10 x 48	Static	PP1048	Silver	247	402
	10 x 60	Static	PP1060	Silver	273	460
	10 x 72	Static	PP1072	Silver	301	519
	10 x 84	Static	PP1084	Silver	383	634
	10 x 90	Static	PP1090	Silver	409	678
	10 x 96 *	Static	PP1096	Silver	409	693

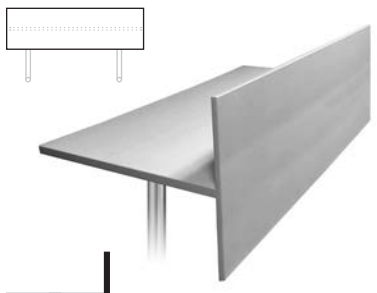
Extended Laminate Privacy Panels	Top Size	Base	Model Number	Hardware	3P	3W
	22 x 36	Static	EPP2236	02 Black	\$ 285	\$ 446
	22 x 48	Static	EPP2248	02 Black	340	535
	22 x 60	Static	EPP2260	02 Black	366	593
	22 x 72	Static	EPP2272	02 Black	413	675
	22 x 84	Static	EPP2284	02 Black	552	852
	22 x 90	Static	EPP2290	02 Black	606	927
	22 x 96 *	Static	EPP2296	02 Black	606	941

accessories

* \$200 NET surcharge per order for oversized pallet

Top Size	Base	Model Number	Hardware	Price	Frosted Acrylic Privacy Panels
10 x 36	Static	PAP1036	Silver	\$ 269	
10 x 48	Static	PAP1048	Silver	311	
10 x 60	Static	PAP1060	Silver	353	
10 x 72	Static	PAP1072	Silver	395	
10 x 84	Static	PAP1084	Silver	494	
10 x 90	Static	PAP1090	Silver	536	
10 x 96 *	Static	PAP1096	Silver	536	

Top Size	Base	Model Number	Hardware	Price	Extended Acrylic Privacy Panels
22 x 36	Static	EPAP2236	Chrome	\$ 374	
22 x 48	Static	EPAP2248	Chrome	454	
22 x 60	Static	EPAP2260	Chrome	533	
22 x 72	Static	EPAP2272	Chrome	613	
22 x 84	Static	EPAP2284	Chrome	739	
22 x 90	Static	EPAP2290	Chrome	779	
22 x 96 *	Static	EPAP2296	Chrome	818	

* \$200 NET surcharge per order for oversized pallet

Metal Pop-up Units

Each of our metal pop-up units feature a single touch door opening which closes when not in use. These units are available in a multitude of configurations balancing your need for conventional (15 amp/125 volt) power with USB power and data jacks. **When ordering electrical components on pages 212-219, it is the responsibility of the customer to ensure the components selected meet local electrical codes.**

Finishes: Choose between Black and Anodized Aluminum.

Cord: Choose between 72" and 120" length. All feature 15 amp/125 volt. Some units require two cords.

Cutout: You do not need to specify a grommet or add any upcharge to your table price. The cost of the cutout is included in the price of the unit.

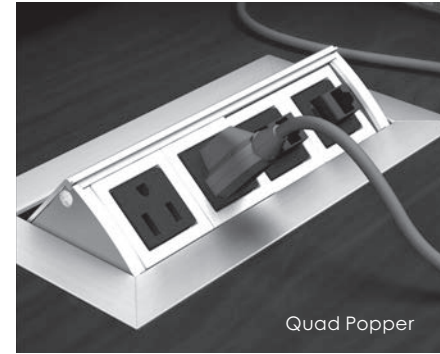

Product	Approx. Size	Configuration	Cord	Model Number	BL	AA
	4 x 5"	2 Power	72"	PD04-2P-72	\$ 256	N/A
			120"	PD04-2P-120	266	N/A
		1 Power + 1 KO	72"	PD04-1P-1D-72	243	N/A
			120"	PD04-1P-1D-120	254	N/A
		1 Power + 2 USB	72"	PD04-1P-2U-72	342	N/A
			120"	PD04-1P-2U-120	353	N/A
	4 x 8"	4 Power	72"	PD06-4P-72	597	467
			120"	PD06-4P-120	607	477
		2 Power + 2 KO	72"	PD06-2P-2D-72	474	372
			120"	PD06-2P-2D-120	484	383
		2 Power + 2 USB + 1 KO	72"	PD06-2P-2U-72	573	472
			120"	PD06-2P-2U-120	584	482
	4 x 11"	6 Power	72"	PD14-6P-72	710	557
			120"	PD14-6P-120	721	567
		3 Power + 3 KO	72"	PD14-3P-3D-72	529	417
			120"	PD14-3P-3D-120	540	427
		4 Power + 2 USB + 1 KO	72"	PD14-4P-2U-72	737	600
			120"	PD14-4P-2U-120	747	610
	8 x 8"	8 Power	72"	PD08-8P-72	1,109	861
			120"	PD08-8P-120	1,130	882
		4 Power + 4 KO	72"	PD08-4P-4D-72	946	735
			120"	PD08-4P-4D-120	967	756
		4 Power + 4 USB + 2 KO	72"	PD08-4P-4U-72	1,145	934
			120"	PD08-4P-4U-120	1,166	955

Where would you like your power units?

For custom locations, please provide a drawing with your order.

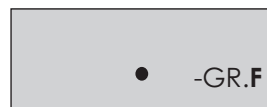
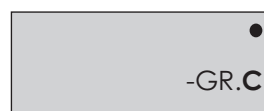

Plastic Units



These units are designed with an eye on the fixed budget. They are available in a multitude of configurations balancing your need for conventional (15 amp/125 volt) power with USB power and data jacks.

Finishes: Choose between Black and White. Other finishes are available for those units marked with "#". Contact TableX customer service for options and pricing.

Cord: Choose between 72" and 120" length. All feature 15 amp/125 volt.

Cutout: You do not need to specify a grommet or add any upcharge to your table price. The cost of the cutout is included in the price of the unit.

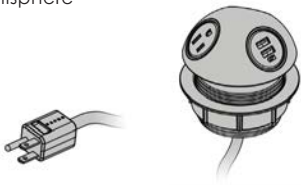

Product	Approx. Size	Configuration	Cord	Model Number	Color	List
	3.75" round	3 Power	72"	PD17-3P-72	-BL -WH -#	\$ 180
			120"	PD17-3P-120	-BL -WH -#	190
		2 Power + 1 USB	72"	PD17-2P-1U-72	-BL -WH -#	260
			120"	PD17-2P-1U-120	-BL -WH -#	270
	5" round	3 Power	72"	PD16-3P-72	-BL -WH	240
			120"	PD16-3P-120	-BL -WH	251
		2 Power + 1 USB	72"	PD16-2P-1U-72	-BL -WH	330
			120"	PD16-2P-1U-120	-BL -WH	340
	2.75 x 7.313 x 2.063"	4 Power	72"	PD18-CO-4P-72	-BL -WH	301
			120"	PD18-CO-4P-120	-BL -WH	312
		2 Power + 2 USB	72"	PD18-CO-2P-2U-72	-BL -WH	369
		+ 1 KO	120"	PD18-CO-2P-2U-120	-BL -WH	380

Additional Outlet Options	Description	Model Number	List
HDMI	- Fits into blank data knockouts with 18" cord	B-HDMI	\$ 110
RJ45/Cat 6	- Fits into blank data knockouts with 120" cord	B-RJ45	\$ 117

p 208-209: Unless specified on order, all USB configurations will be an A+C USB Dual Port.

Villa™ Daisylink™ System

The Villa Daisylink system is a 4 wire, 2 circuit hardwire system which allows for non-sequential plug and play use. Link up to 20 single kits or 10 double kits in a row using one of three power infeed options.

Grommet holes are pre-routed in the top, and each unit comes with a flush grommet cover.

3 finishes available:

- BL: Black grommet, black body
- SV: Silver grommet, silver body
- WH: White grommet, black body

Infeeds: You must specify a power infeed unit for each row or grouping of tables. The number of kits that can be supported per row varies depending on the infeed specified.



Single Kit includes:

- 1 Villa power base
- 1 FM cable
- 1 FF cable
- 4 cable clamps
- 1 grommet (on -L / -F models)



Double Kit includes:

- 2 Villa power bases
- 1 FM cable
- 2 FF cable
- 6 cable clamps
- 2 grommets (on -L / -F models)

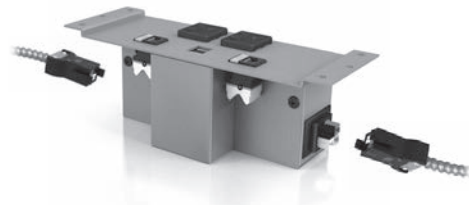

How Does the Villa Daisylink System Work?

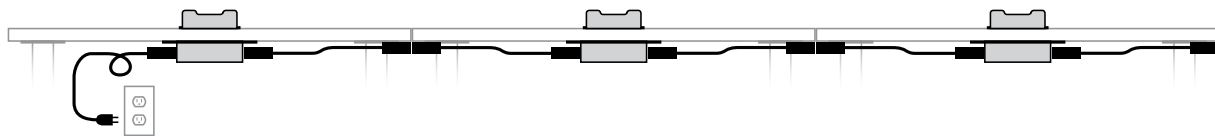



Daisylink Accessories	Description	Visual	Cord	Model Number	Price
20/15 AMP Plug Infeed 	- 20 AMP outlet with standard 15 AMP adapter can be plugged into any standard wall outlet. - Feeds up to 10 units. - 20 total receptacles		72	VAP-72	\$200
Hardwire Infeed 	- 2 circuit system hardwired into wall and plugs into first table in the row. - Feeds up to 20 units.		72	VHW-72	159
			120	VHW-120	228
Quick Disconnect Kit 	- Hardwired wall unit paired with an FF jumper unit which plugs into first table in the row. - Feeds up to 20 units.		72	VQD-72	265
			120	VQD-120	328
FM Jumper Unit 	- Great for linking tables around a corner, face to face, bypassing a non-powered table, or two tables that are not in perfect alignment.		12	VFM-12	86
			24	VFM-24	101
			36	VFM-36	117
			48	VFM-48	133
			60	VFM-60	148
			72	VFM-72	164
Splitter 	- Splits power to feed tables running in different directions			VT-MFM	137

accessories

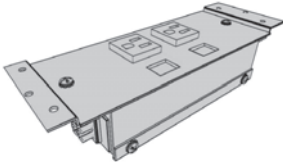
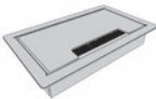
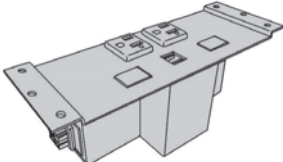
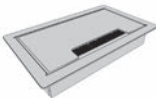
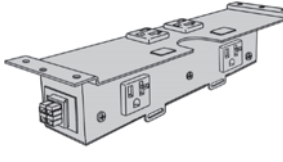
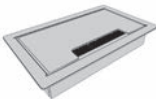
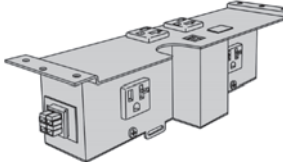
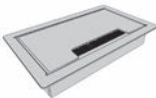
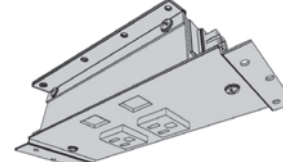
Single Villa Kits	Double Villa Kits
-------------------	-------------------

Villa Daisylink Kits	Grommet Cover	Table Size	Model No.	List	Model No.	List
		36"	V36SP-2P	402	N/A	
		48"	V48SP-2P	402	N/A	
		60"	V60SP-2P	402	V60DP-2P	735
		72"	V72SP-2P	402	V72DP-2P	735
		84"	V84SP-2P	N/A	V84DP-2P	735
		90"	V90SP-2P	N/A	V90DP-2P	
		96"	V96SP-2P	N/A	V96DP-2P	735
		36"	V36SP-2P-1U	533	N/A	
		48"	V48SP-2P-1U	533	N/A	
		60"	V60SP-2P-1U	533	V60DP-2P-1U	998
		72"	V72SP-2P-1U	533	V72DP-2P-1U	998
		84"	V84SP-2P-1U	N/A	V84DP-2P-1U	998
		90"	V90SP-2P-1U	N/A	V90DP-2P-1U	N/A
		96"	V96SP-2P-1U	N/A	V96DP-2P-1U	998
		36"	V36SP-2P-2C	468	N/A	
		48"	V48SP-2P-2C	468	N/A	
		60"	V60SP-2P-2C	468	V60DP-2P-2C	781
		72"	V72SP-2P-2C	468	V72DP-2P-2C	781
		84"	V84SP-2P-2C	N/A	V84DP-2P-2C	781
		90"	V90SP-2P-2C	N/A	V90DP-2P-2C	N/A
		96"	V96SP-2P-2C	N/A	V96DP-2P-2C	781
		36"	V36SP-2P-1U-2C	599	N/A	
		48"	V48SP-2P-1U-2C	599	N/A	
		60"	V60SP-2P-1U-2C	599	V60DP-2P-1U-2C	1,043
		72"	V72SP-2P-1U-2C	599	V72DP-2P-1U-2C	1,043
		84"	V84SP-2P-1U-2C	N/A	V84DP-2P-1U-2C	1,043
		90"	V90SP-2P-1U-2C	N/A	V90DP-2P-1U-2C	N/A
		96"	V96SP-2P-1U-2C	N/A	V96DP-2P-1U-2C	1,043
	None	36"	V36SP-2C	454	N/A	
		48"	V48SP-2C	454	N/A	
		60"	V60SP-2C	454	V60DP-2C	602
		72"	V72SP-2C	454	V72DP-2C	602
		84"	V84SP-2C	454	V84DP-2C	602
		90"	V90SP-2C	N/A	V90DP-2C	N/A
		96"	V96SP-2C	454	V96DP-2C	602

Villa Accessories	Description	Model Number	List
	- Fits into blank data knockouts	V-RJ45	\$ 61
	- Fits into blank data knockouts	V-HDMI	\$ 65

"Villa" and "Daisylink" are trademarks of Electri-Cable Assemblies.

Cove™ Daisylink™ System

The Cove Daisylink system is a 4 wire, 2 circuit hardwire system which allows for non-sequential plug and play use. Link up to 20 single kits or 10 double kits in a row using one of three power infeed options.

Grommet holes are pre-routed in the top. All outlets and body of unit is black.

3 face plate finishes available:

- BL: Black
- SV: Silver
- WH: White

Infeeds: You must specify a power infeed unit for each row or grouping of tables. The number of kits that can be supported per row varies depending on the infeed specified.



Single Cove Kit

Single Kit includes:

- 1 Cove power base
- 1 FM cable
- 1 FF cable
- 4 cable clamps
- 1 grommet (on -L / -F models)



Double Cove Kit

Double Kit includes:

- 2 Cove power bases
- 1 FM cable
- 2 FF cable
- 6 cable clamps
- 2 grommets (on -L / -F models)





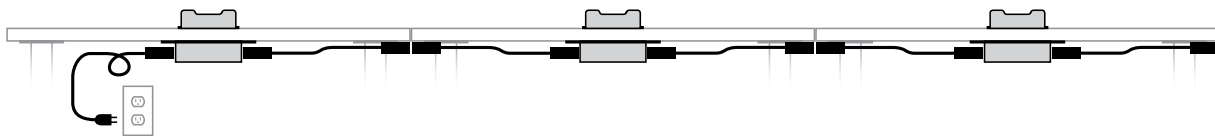





How Does the Cove Daisylink System Work?

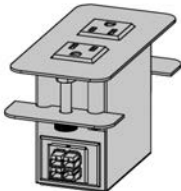

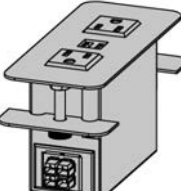
Daisylink Accessories	Description	Visual	Cord	Model Number	Price
20/15 AMP Plug Infeed 	- 20 AMP outlet with standard 15 AMP adapter can be plugged into any standard wall outlet. - Feeds up to 10 units.		72	VAP-72	\$ 200
Hardwire Infeed 	- 2 circuit system hardwired into wall and plugs into first table in the row. - Feeds up to 20 units.		72	VHW-72	159
Quick Disconnect Kit 	- Hardwired wall unit paired with an FF jumper unit which plugs into first table in the row. - Feeds up to 20 units.		72	VQD-72	265
FM Jumper Unit 	- Great for linking tables around a corner, face to face, bypassing a non-powered table, or two tables that are not in perfect alignment.		12	VFM-12	86
			24	VFM-24	101
			36	VFM-36	117
			48	VFM-48	133
			60	VFM-60	148
			72	VFM-72	164
Splitter 	- Splits power to feed tables running in different directions			VT-MFM	137

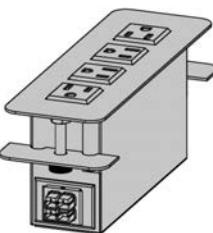
accessories

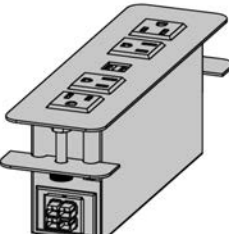
Single Cove Kits	Double Cove Kits
------------------	------------------

Cove Daisylink Kits	Face Plate	Table Size	Model No.	List	Model No.	List
2 Power 	2.5 x 5" 	36"	C36SP-2P	438	N/A	
		48"	C48SP-2P	438	N/A	
		60"	C60SP-2P	438	C60DP-2P	768
		72"	C72SP-2P	438	C72DP-2P	768
		84"	C84SP-2P	N/A	C84DP-2P	768
		96"	C96SP-2P	N/A	C96DP-2P	768
2 Power + 2 USB 	2.5 x 5.75" 	36"	C36SP-2P-2U	570	N/A	
		48"	C48SP-2P-2U	570	NA	
		60"	C60SP-2P-2U	570	C60DP-2P-2U	1,026
		72"	C72SP-2P-2U	570	C72DP-2P-2U	1,026
		84"	C84SP-2P-2U	N/A	C84DP-2P-2U	1,026
		96"	C96SP-2P-2U	N/A	C96DP-2P-2U	1,026
4 Power 	2.5 x 7.75" 	36"	C36SP-4P	632	N/A	
		48"	C48SP-4P	632	NA	
		60"	C60SP-4P	632	C60DP-4P	1,154
		72"	C72SP-4P	632	C72DP-4P	1,154
		84"	C84SP-4P	N/A	C84DP-4P	1,154
		96"	C96SP-4P	N/A	C96DP-4P	1,154
4 Power + 2 USB 	2.5 x 8.75" 	36"	C36SP-4P-2U	763	N/A	
		48"	C48SP-4P-2U	763	NA	
		60"	C60SP-4P-2U	763	C60DP-4P-2U	1,413
		72"	C72SP-4P-2U	763	C72DP-4P-2U	1,413
		84"	C84SP-4P-2U	N/A	C84DP-4P-2U	1,413
		96"	C96SP-4P-2U	N/A	C96DP-4P-2U	1,413

"Cove" & "Daisylink" are trademarks of Electri-Cable Assemblies.

Villa™ Corded System

This system is built with easy plug-and-play capabilities and reconfiguration in mind. Each table can be plugged into the wall separately or can be piggy-backed off of the next table. (Max of 6 units in any run.)

Grommet holes are pre-routed in the top, and each unit comes with a flush grommet cover.

3 finishes available:



- BL: Black grommet, black body
- SV: Silver grommet, silver body
- WH: White grommet, black body

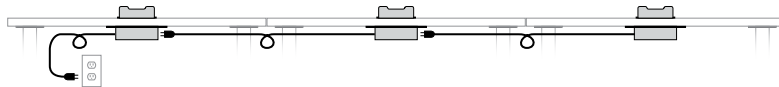

How Does the Villa Corded System Work?

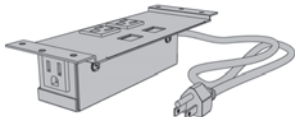
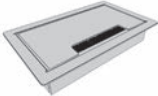
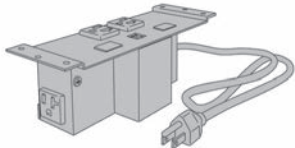
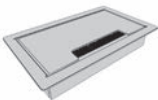
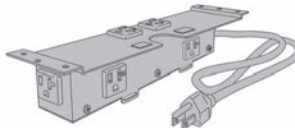
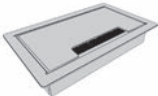
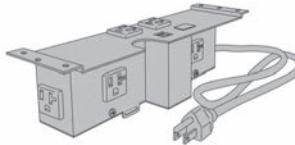
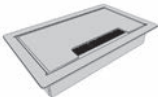
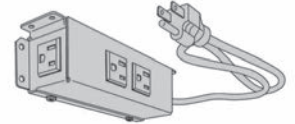

Villa Corded Units	Grommet Cover	Model Number	Cord	Color	List
2 Power + 1 Convenience + 2 KO 	3.25 x 5.5" Flush 	VC-2P-1C-__-__	-36 -72 -108	-BL -SV	\$ 291
2 Power + 2 USB + 1 Convenience + 2 KO 	3.25 x 5.5" Flush 	VC-2P-2U-1C-__-__	-36 -72 -108	-BL -SV	\$ 423
2 Power + 3 Convenience + 2 KO 	3.25 x 5.5" Flush 	VC-2P-3C-__-__	-36 -72 -108	-BL -SV	\$ 339
2 Power + 2 USB + 3 Convenience + 1 KO 	3.25 x 5.5" Flush 	VC-2P-2U-3C-__-__	-36 -72 -108	-BL -SV	\$ 463
3 Convenience Undermount 	None	VC-3C-__-__	-36 -72 -108	-BL -SV	\$ 209

Villa Accessories	Description	Model Number	List
Villa RJ45 Data Keystone 	- Fits into blank data knockouts	V-RJ45	\$ 61
Villa HDMI Keystone 	- Fits into blank data knockouts	V-HDMI	\$ 65

accessories

Cove™ Corded System

Smooth access to power and USB power that runs flush to the table top.











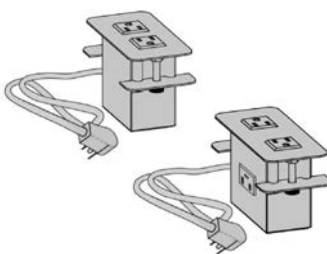

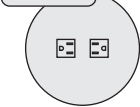
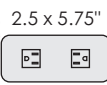
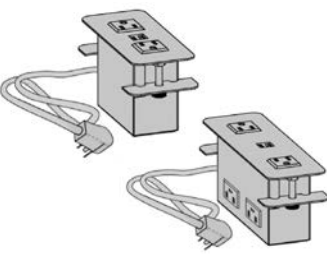

Some models are available with convenience outlets to allow table to be piggy-backed off of the next table. (Max of 6 units in any run.)

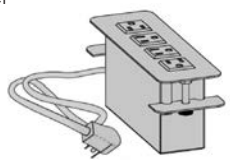
Grommet holes are pre-routed in the top. All outlets and body of unit is black.

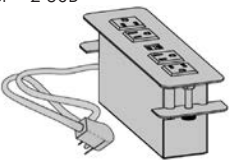
3 face plate finishes available:

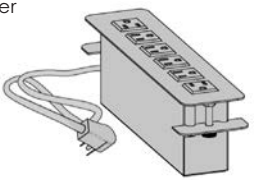

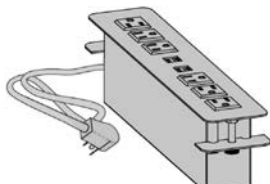
- BL: Black
- SV: Silver
- WH: White





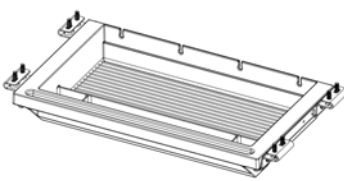

Cove Corded Units	Face Plate	Specs	Model Number	Color	List
	 2.5 x 5"  6"	Rectangle Round	CC108-2P CC108-2P-RD	-BL -SV -BL -SV	\$ 292 \$ 292
	 2.5 x 5.75"	Rectangle +1 Convenience	CC108-2P-1C	-BL -SV	\$ 312
	 2.5 x 5.75"  6"	Rectangle Round	CC108-2P-2U CC108-2P-2U-RD	-BL -SV -BL -SV	\$ 419 \$ 419
	 2.5 x 7.75"	Rectangle +2 Convenience	CC108-2P-2U-2C	-BL -SV	\$ 551
	 2.5 x 7.75"	Rectangle	CC108-4P	-BL -SV	\$ 485
	 2.5 x 8.75"	Rectangle	CC108-4P-2U	-BL -SV	\$ 526
	 2.5 x 10.75"	Rectangle	CC108-6P	-BL -SV	\$ 506
	 2.5 x 13.25"	Rectangle	CC108-6P-4U	-BL -SV	\$ 699

"Cove" is a trademark of Electri-Cable Assemblies.

Product	Description	Length	Model Number	Color	Price
Built-in Wire Management Leg 	1 x 19" steel hinged access door built into one base. Door runs within 2.5" of top plate and bottom of base. Door height varies depending on series and options. Not available on all series. Check series intro for compatibility. Upcharge is \$132 per table.	N/A	-WM	matches base color	+\$ 132 - - -
Snap-on Wire Management Leg Cover 	Snaps on to round columns and offers coverage of wires down the leg. Check series intro for compatibility. Powdercoated steel to match base color (not available in chrome). Available for 2" and 3" columns.	N/A	-WMLC.2 -WMLC.3	matches base color	47 75 - -
Magnetic Wire Management Leg Cover 	Magnetically attaches to rectangular and square bases, offering coverage of wires down the leg. Check series intro for compatibility. Powdercoated steel to match base color.	N/A	-MMLC	matches base color	67 - - -
Vertical Spine Management 3 x 1.5 	Oval spine conceals and carries wires from under desk to floor. Single channel on each side to keep cords separate where code requires. Screws to under side of worksurface with weighted base. Available in Silver Metallic.	30" 42"	WMH WMH-SH	Silver Silver	165 229 - -
J-Channel Management 3.25 x 1" 	Ideal when cords need to be moved often. Can be attached to underside of the table or to a modesty panel. Self adhesive tape applied for easy installation. Black plastic.	12" 36" 60" 72"	WMA1 WMA3 WMA5 WMA6	Black Black Black Black	102 132 181 195 -
Cable Gripper 3.62 x 2.62 x 1.5" 	This cable manager features an intelligent design that allows wires to slip into the unit. Place these grips anywhere you need to get wires under control. Simple to install with only four screws, users can easily move to different positions as their work environment changes.	N/A	CG4	Black	17

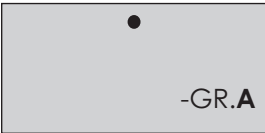
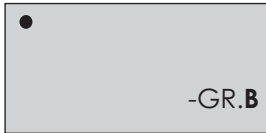
Product	Description	Length	Model Number	Color	Price
Vertebrae Management 3.125 x 1" 	Contains four separate channels. Two main channels and two smaller which allow wires to sit in a .5" trough. Black plastic.	36"	WMD3	Black	\$ 108
Grommet 2.75 x 2.75" 	Add grommets to any table top for \$42 each. Use chart below to select grommet location. For example, add "-GR.D" at the end of the model number for a table needing two grommets in location D and add \$84 to the list price. Black plastic.	N/A	-GR.---	Black	+42 ea.
MINI Drawer 13.6"w x 8"d x 2"h 	A thin-profile, non-locking drawer with ball bearing slides designed to fit underneath work surfaces, especially height-adjustable tables. The MINI drawer is only 8" in depth and features a tray that can slide across the drawer and can also be removed and placed on the work surface to hold accessories or personal items. The tray also allows for easy-access storage inside the drawer. Wire management slots on the backside of the MINI allow the user to place items such as their mobile phone inside and then draw the charging cord out the back.	N/A	-MD	Black	\$99

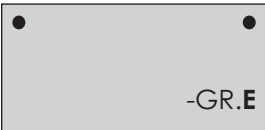
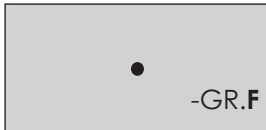
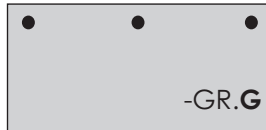
Where Would You Like Your Grommets? For custom locations, please provide a drawing with your order.

 -GR.A	 -GR.B	 -GR.C	 -GR.D
 -GR.E	 -GR.F	 -GR.G	 -GR.DF

Please note: GR.F and GR.DF are NOT available on nesting tables

accessories