

table 

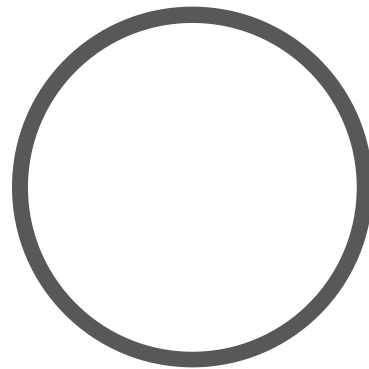

99 surge
price list
Effective January 1, 2023

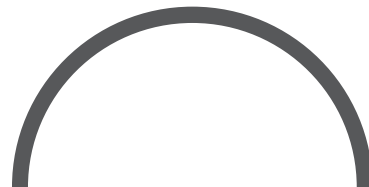



Surge series tables are sleek, stylish, and versatile. With height adjustable options and a variety of top shapes and sizes, Surge provides a sophisticated solution for any space.

Surge Base Styles

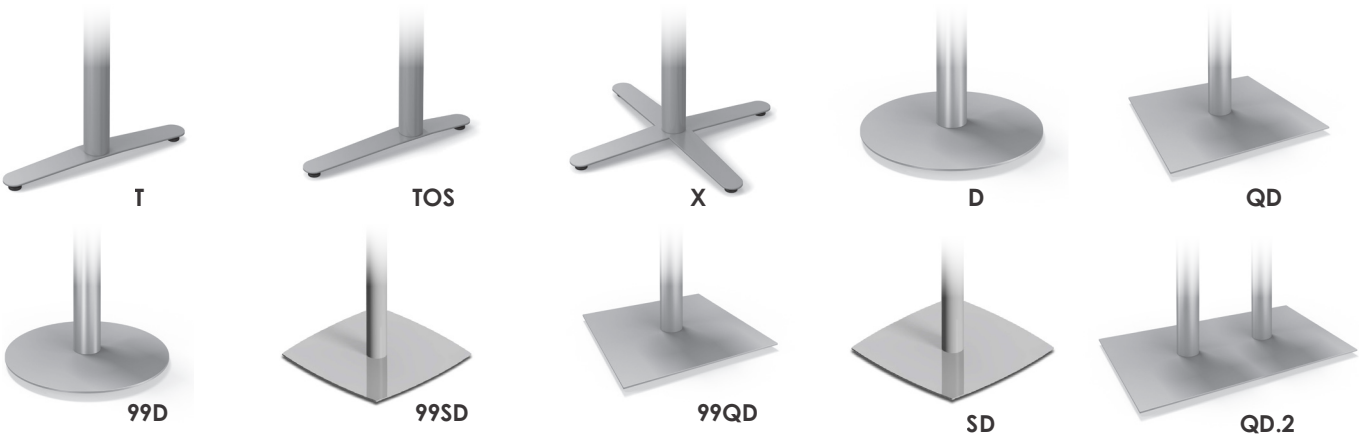

Surge Options

Standard Glides



Locking Casters



- LC Locking Casters**
can be added to any table for \$111 per set of four.
- FD Folding Bases**
priced accordingly with standard glides.
- NE Nesting Tables**
priced accordingly with locking casters.
- FT Flip Tops**
available on disc and X-based tables for \$138. Not available on counterbalanced tables.

- OS Offset T-bases**
available for \$39 per table.
- CH Chrome Finish**
is not available on Surge tables.
- WM Wire Management**
Built-in wire management is not available on Surge tables.
- WMLC Wire Management Leg Covers**
snap onto any round column and are \$50 each for 2" and \$79 each for 3".

- SH Special Height**
can be added to any table:
+ \$72 per column for heights > 29"
+ \$39 per column for heights < 29"
Special height tables with tops larger than 36x72" must be custom quoted.
- FR Footring**
is not available on Surge tables.
- PB Powerbox Mounting Plate**
is available on disc and X-bases for \$100.

Surge Height Adjustable Options

EH Electric Height is available on T-bases and is available in two finishes:

- 37 Satin Silver
- 57 Jet

BL Counterbalanced and Short Balanced are available on disc and X-bases. Available height adjustable finishes can be found on page 9.

Surge Top Shapes

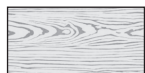

Rectangle
p.200



Boat
p.203



Racetrack
p.204



Elliptical
p.205



Squircle
p.206



Square
p.206



Round
p.207



D-shaped
p.208



Half Round
p.210



Trapezoid
p.210

Surge Top Options

GG Quick-Connect Ganging Brackets can be added to any table for \$45 (includes 4 connectors per table).

GN Ganging Plates & Knobs can be added to most table shapes for \$45 (includes 2 plates & 8 knobs per table).

RC 3" Radius Corners can be added to any table for \$61.

GR Grommets can be added to any table for \$45 each. To see specific locations, see page 227.

Surge Edge Options

(corresponds with 3 columns of pricing)

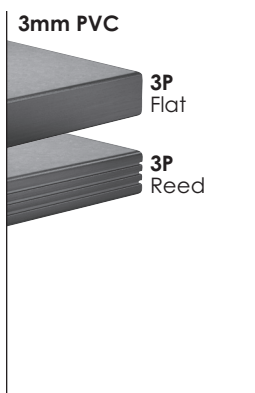

Electric Height Adjustable T-bases

Electric height adjustability gives you the ability to go from sitting to standing height at the push of a button. With a weight capacity of 225 lbs. per table, Surge is strong enough to work in many different applications.

The standard memory keypad will remember your four favorite heights.

Want to use Surge on the go? Simply add 2" to each vertical measurement to account for locking casters.

To specify:
All available electric models are priced in the following pages. They are denoted by the "EH" at the end of the model number.

Example:
99TC2460T22EH-3P
24x60" **electric height** table

\$2,424 List Price

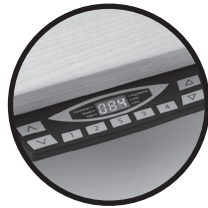

Standard Memory Keypad

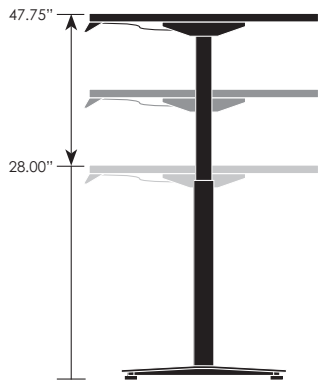

T-bases

Counterbalanced & Short Balanced Height Adjustable Disc & X-bases

Counterbalanced tables go from seated-to-standing height, while the short balanced goes from coffee-to-seated height. Available on tables using single column disc or X-bases, these tables are easy to adjust. Simply squeeze the small handle underneath and gently move the top to your desired height. It's that easy.

Want to use Surge on the go? Simply add 2" to each vertical measurement to account for the added height of locking casters.

To specify:

All available counterbalanced models are priced in the following pages. They are denoted by the "BL" or "BLS" (for short balanced) at the end of the model number.

Example:

99RD36X30BL-3P
36" round **counterbalanced** table
\$1,914 List Price

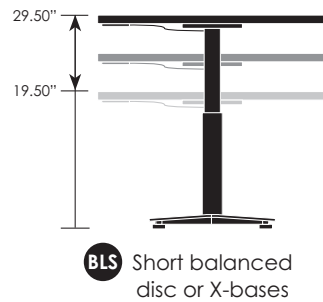
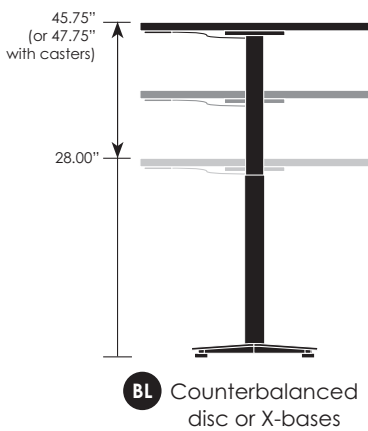
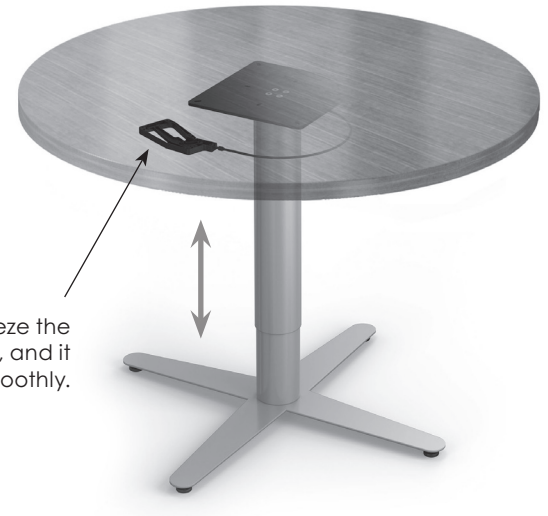

Counterbalanced Height Ranges:

Smaller Surge tables using smaller bases have a 17.75" range, while the larger tables using larger bases have an extended range of 19.75". See the list below for ranges of used on specific top shapes and sizes. All counterbalanced tables have a starting height of 28".

Square	Range	Max Ht.	Round	Range	Max Ht.
36" SQ	19.75"	47.75"	36" RD-X	17.75"	45.75"
42" SQ			36" BU		
			36" RD-D	19.75"	47.75"
			42" RD		
			48" RD		

surge

Rectangular with T-bases	Top Size	Base	Model Number	3P	3K	3W
    <p>Folding T Nesting T Electric Height Adjustable</p>	24 x 36	Static	99TC2436T22	\$ 787	\$ 858	\$ 960
		Nesting	99TC2436T22NE	1,478	1,548	1,648
		Electric	99TC2436T22EH	2,462	2,532	2,635
	24 x 48	Static	99TC2448T22	845	939	1,055
		Folding	99TC2448T22FD	1,173	1,267	1,383
		Nesting	99TC2448T22NE	1,535	1,627	1,740
		Electric	99TC2448T22EH	2,519	2,613	2,729
	24 x 60	Static	99TC2460T22	871	976	1,116
		Folding	99TC2460T22FD	1,212	1,317	1,456
		Nesting	99TC2460T22NE	1,561	1,664	1,800
		Electric	99TC2460T22EH	2,546	2,651	2,789
	24 x 72	Static	99TC2472T22	920	1,045	1,201
Folding		99TC2472T22FD	1,263	1,386	1,542	
Nesting		99TC2472T22NE	1,844	1,967	2,119	
Electric		99TC2472T22EH	2,595	2,720	2,875	
24 x 84	Static	99TC2484T22	1,106	1,268	1,426	
	Folding	99TC2484T22FD	1,358	1,521	1,679	
	Nesting	99TC2484T22NE	1,939	2,099	2,254	
24 x 90	Static	99TC2490T22	1,163	1,349	1,505	
	Folding	99TC2490T22FD	1,417	1,602	1,758	
	Nesting	99TC2490T22NE	1,995	2,177	2,330	
24 x 96 *	Static	99TC2496T22	1,163	1,349	1,520	
	Folding	99TC2496T22FD	1,417	1,602	1,774	
	Nesting	99TC2496T22NE	1,995	2,177	2,346	
30 x 36	Static	99TC3036T26	837	926	1,031	
	Nesting	99TC3036T26NE	1,529	1,615	1,717	
	Electric	99TC3036T26EH	2,514	2,601	2,707	
30 x 48	Static	99TC3048T26	910	1,025	1,141	
	Folding	99TC3048T26FD	1,238	1,354	1,468	
	Nesting	99TC3048T26NE	1,599	1,712	1,824	
	Electric	99TC3048T26EH	2,586	2,702	2,817	
30 x 60	Static	99TC3060T26	932	1,057	1,196	
	Folding	99TC3060T26FD	1,273	1,398	1,538	
	Nesting	99TC3060T26NE	1,620	1,742	1,880	
	Electric	99TC3060T26EH	2,608	2,733	2,872	
30 x 72	Static	99TC3072T26	986	1,134	1,289	
	Folding	99TC3072T26FD	1,329	1,476	1,629	
	Nesting	99TC3072T26NE	1,909	2,054	2,204	
	Electric	99TC3072T26EH	2,663	2,810	2,965	

* \$200 NET surcharge per order for oversized pallet

For Surge table options, please reference pages 196-199.

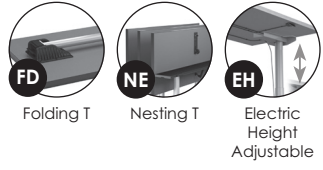
Top Size	Base	Model Number	3P	3K	3W	Rectangular with T-bases	
30 x 84	Static	99TC3084T26	\$ 1,210	\$ 1,412	\$ 1,557		
	Folding	99TC3084T26FD	1,464	1,666	1,811		
	Nesting	99TC3084T26NE	2,042	2,240	2,381		
30 x 90	Static	99TC3090T26	1,283	1,512	1,650		
	Folding	99TC3090T26FD	1,536	1,767	1,904		
30 x 96 *	Static	99TC3096T26	1,283	1,512	1,666		
	Folding	99TC3096T26FD	1,536	1,767	1,919		
36 x 48	Static	99TC3648T26	965	1,105	1,218		
	Folding	99TC3648T26FD	1,293	1,432	1,546		
	Nesting	99TC3648T26NE	1,785	1,922	2,033		
	Electric	99TC3648T26EH	2,641	2,781	2,894		
36 x 60	Static	99TC3660T26	1,050	1,223	1,342		
	Folding	99TC3660T26FD	1,393	1,564	1,684		
	Nesting	99TC3660T26NE	1,945	2,113	2,231		
	Electric	99TC3660T26EH	2,726	2,900	3,018		
36 x 72	Static	99TC3672T26	1,103	1,297	1,432		
	Folding	99TC3672T26FD	1,445	1,640	1,774		
	Nesting	99TC3672T26NE	2,024	2,215	2,346		
	Electric	99TC3672T26EH	2,779	2,974	3,107		
36 x 84	Static	99TC3684T26	1,309	1,549	1,679		
	Folding	99TC3684T26FD	1,561	1,802	1,932		
36 x 90	Static	99TC3690T26	1,393	1,666	1,787		
	Folding	99TC3690T26FD	1,645	1,919	2,041		
36 x 96 *	Static	99TC3696T26	1,393	1,666	1,802		
	Folding	99TC3696T26FD	1,645	1,919	2,056		

* \$200 NET surcharge per order for oversized pallet

For Surge table options, please reference pages 196-199.

Rectangular with 2 Thin Disc Bases	Top Size	Base	Model Number	3P	3K	3W
	24 x 60	Static	99TC2460D20	\$ 1,477	\$ 1,581	\$ 1,720
	24 x 72	Static	99TC2472D20	1,527	1,650	1,805
	24 x 84	Static	99TC2484D20	1,623	1,784	1,944
	24 x 90	Static	99TC2490D20	1,769	1,953	2,110
	24 x 96 *	Static	99TC2496D20	1,769	1,953	2,126
	30 x 60	Static	99TC3060D20	1,529	1,653	1,793
	30 x 72	Static	99TC3072D20	1,584	1,732	1,885
	30 x 84	Static	99TC3084D20	1,719	1,922	2,066
	30 x 90	Static	99TC3090D20	1,880	2,109	2,247
	30 x 96 *	Static	99TC3096D20	1,880	2,109	2,263
	36 x 72	Static	99TC3672D24	1,781	1,977	2,110
	36 x 84	Static	99TC3684D24	1,899	2,138	2,268
	36 x 90	Static	99TC3690D24	2,070	2,345	2,465
	36 x 96 *	Static	99TC3696D24	2,070	2,345	2,481
	42 x 72	Static	99TC4272D32	2,172	2,414	2,528
	42 x 84	Static	99TC4284D32	2,267	2,550	2,664
	42 x 90	Static	99TC4290D32	2,451	2,769	2,872
	42 x 96 *	Static	99TC4296D32	2,451	2,769	2,887

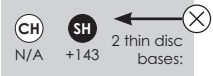

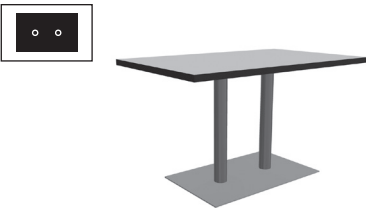
Rectangle with 2-column Disc Base	Top Size	Base	Model Number	3P	3K	3W
	24 x 36	Static	99TC2436QD2032.2	\$ 1,389	\$ 1,460	\$ 1,562
	24 x 48	Static	99TC2448QD2032.2	1,446	1,540	1,656
	30 x 36	Static	99TC3036QD2032.2	1,431	1,519	1,624
	30 x 48	Static	99TC3048QD2032.2	1,503	1,619	1,733
	36 x 48	Static	99TC3648QD2032.2	1,559	1,696	1,811

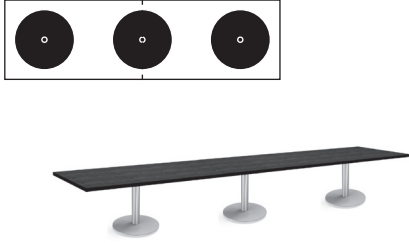
Rectangular with 3 Thin Disc Bases	Top Size	Base	Model Number	3P	3K	3W
	42 x 120	Static	99TC42120D32(3)-TJ	\$3,586	\$ 4,061	\$ 4,124
	42 x 144	Static	99TC42144D32(3)-TJ	3,780	4,332	4,400



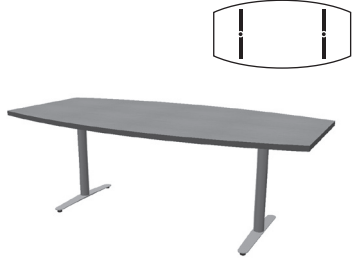

* \$200 NET surcharge per order for oversized pallet

For Surge table options, please reference pages 196-199.

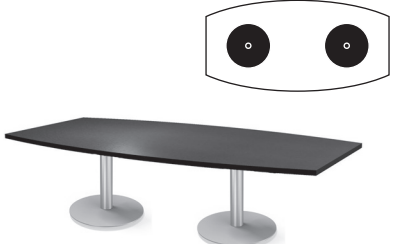



Top Size	Base	Model Number	3P	3K	3W	Boat-shaped with T-bases
30 x 42 x 84	Static	99BT3084T26	\$1,662	\$2,044	\$2,037	
30 x 42 x 90	Static	99BT3090T26	1,797	2,234	2,201	
30 x 42 x 96 *	Static	99BT3096T26	1,797	2,234	2,217	

Top Size	Base	Model Number	3P	3K	3W	Boat-shaped with 2 Thin Disc Bases
30 x 42 x 84	Static	99BT3084D24	\$2,252	\$2,634	\$2,628	
30 x 42 x 90	Static	99BT3090D24	2,475	2,911	2,880	
30 x 42 x 96 *	Static	99BT3096D24	2,475	2,911	2,895	
36 x 48 x 84	Static	99BT3684D32	2,654	3,090	3,052	
36 x 48 x 90	Static	99BT3690D32	2,896	3,393	3,325	
36 x 48 x 96 *	Static	99BT3696D32	2,896	3,393	3,341	

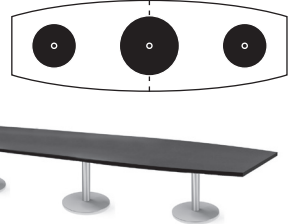







 2 thin disc bases: N/A +143

Top Size	Base	Model Number	3P	3K	3W	Boat-shaped with 3 Thin Disc Bases
36 x 48 x 120	Static	99BT36120D243224-TJ	\$3,877	\$4,575	\$4,435	
36 x 48 x 144	Static	99BT36144D243224-TJ	4,186	5,006	4,836	







 3 thin disc bases: N/A +215

* \$200 NET surcharge per order for oversized pallet

For Surge table options, please reference pages 196-199.



Racetrack with T-bases	Top Size	Base	Model Number	3P	3K	3W
    <p>Folding T Nesting T Electric Height Adjustable</p>	36 x 60	Static	99RT3660T26	\$ 1,322	\$ 1,605	\$ 1,603
		Nesting	99RT3660T26NE	2,136	2,413	2,411
		Electric	99RT3660T26EH	2,990	3,271	3,269
	36 x 72	Static	99RT3672T26	1,322	1,605	1,634
		Folding	99RT3672T26FD	1,665	1,947	1,976
		Nesting	99RT3672T26NE	2,213	2,488	2,517
		Electric	99RT3672T26EH	2,990	3,271	3,300
	36 x 84	Static	99RT3684T26	1,658	2,040	2,024
		Folding	99RT3684T26FD	1,911	2,292	2,278
	36 x 90	Static	99RT3690T26	1,797	2,234	2,193
		Folding	99RT3690T26FD	2,050	2,486	2,446
	36 x 96 *	Static	99RT3696T26	1,797	2,234	2,209
Folding		99RT3696T26FD	2,050	2,486	2,462	

Racetrack with 2 Thin Disc Bases	Top Size	Base	Model Number	3P	3K	3W
	36 x 72	Static	99RT3672D20	\$ 1,921	\$ 2,202	\$ 2,232
	36 x 84	Static	99RT3684D20	2,168	2,548	2,533
	36 x 90	Static	99RT3690D20	2,394	2,830	2,789
	36 x 96 *	Static	99RT3696D20	2,394	2,830	2,806
	42 x 84	Static	99RT4284D24	2,249	2,630	2,623
	42 x 90	Static	99RT4290D24	2,475	2,911	2,880
	42 x 96 *	Static	99RT4296D24	2,475	2,911	2,895
	48 x 84	Static	99RT4884D32	2,808	3,305	3,220
	48 x 90	Static	99RT4890D32	2,896	3,393	3,324
	48 x 96 *	Static	99RT4896D32	2,896	3,393	3,339

 N/A +143 2 thin disc bases:

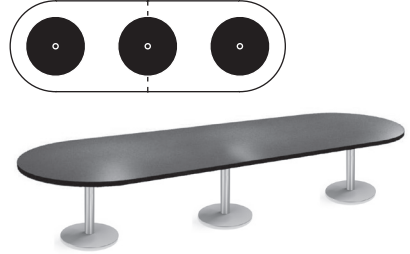
Racetrack with 3 Thin Disc Bases	Top Size	Base	Model Number	3P	3K	3W
	42 x 120	Static	99RT42120D24(3)	\$ 3,726	\$ 4,418	\$ 4,272
	42 x 144	Static	99RT42144D24(3)	4,031	4,844	4,670
	48 x 120	Static	99RT48120D32(3)	4,146	4,843	4,702
	48 x 144	Static	99RT48144D32(3)	4,454	5,276	5,103

 N/A +215 3 thin disc bases:

* \$200 NET surcharge per order for oversized pallet

For Surge table options, please reference pages 196-199.

Top Size	Base	Model Number	3P	3K	3W	Elliptical with T-bases
30 x 54	Static	99EL3054T22	\$ 1,055	\$ 1,233	\$ 1,271	
	Electric	99EL3054T22EH	2,729	2,908	2,946	
30 x 60	Static	99EL3060T22	1,102	1,299	1,335	
	Electric	99EL3060T22EH	2,777	2,973	3,009	
36 x 60	Static	99EL3660T26	1,210	1,446	1,465	
	Electric	99EL3660T26EH	2,886	3,123	3,141	
36 x 72	Static	99EL3672T26	1,322	1,605	1,614	
	Electric	99EL3672T26EH	2,999	3,281	3,290	
36 x 84	Static	99EL3684T26	1,530	1,860	1,857	
36 x 90	Static	99EL3690T26	1,644	2,018	1,993	
36 x 96 *	Static	99EL3696T26	1,644	2,018	2,005	



Top Size	Base	Model Number	3P	3K	3W	Elliptical with 2 Thin Disc Bases
36 x 72	Static	99EL3672D20	\$ 1,921	\$ 2,202	\$ 2,211	
36 x 84	Static	99EL3684D20	2,039	2,368	2,366	
36 x 90	Static	99EL3690D20	2,240	2,615	2,591	
36 x 96 *	Static	99EL3696D20	2,240	2,615	2,602	
42 x 72	Static	99EL4272D24	2,120	2,450	2,434	
42 x 84	Static	99EL4284D24	2,249	2,630	2,599	
42 x 90	Static	99EL4290D24	2,478	2,915	2,855	
42 x 96 *	Static	99EL4296D24	2,478	2,915	2,867	
48 x 84	Static	99EL4884D32	2,808	3,306	3,202	
48 x 90	Static	99EL4890D32	2,897	3,394	3,302	
48 x 96 *	Static	99EL4896D32	2,897	3,394	3,314	

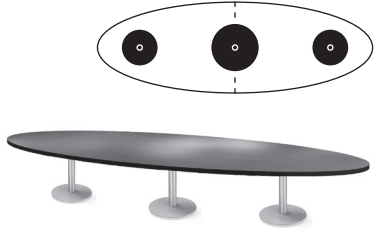

⊗ → CH SH
2 thin disc bases: N/A +143







Top Size	Base	Model Number	3P	3K	3W	Elliptical with 3 Thin Disc Bases
42 x 120	Static	99EL42120D24(3)	\$ 3,726	\$ 4,418	\$ 4,229	
42 x 144	Static	99EL42144D24(3)	4,031	4,844	4,614	
48 x 120	Static	99EL48120D32(3)	4,146	4,843	4,662	
48 x 144	Static	99EL48144D32(3)	4,454	5,276	5,050	



⊗ → CH SH
3 thin disc bases: N/A +215

* \$200 NET surcharge per order for oversized pallet





For Surge table options, please reference pages 196-199.



Squiracle with X-base	Top Size	Base	Model Number	3P	3K	3W
  Short Balanced Ht. Adjustable  Counter-balanced Ht. Adjustable	24 x 24	Static	99SL24X22	\$ 851	\$ 987	\$ 1,010
		Short Bal	99SL24X22BLS	1,466	1,603	1,625
	30 x 30	Static	99SL30X26	914	1,074	1,109
		Short Bal	99SL30X26BLS	1,533	1,693	1,730
	36 x 36	Static	99SL36X30	1,073	1,259	1,306
		Short Bal	99SL36X30BLS	2,040	2,225	2,274
		Count Bal	99SL36X30BL	2,040	2,225	2,274
	42 x 42	Static	99SL42X30	1,144	1,359	1,416
		Short Bal	99SL42X30BLS	2,112	2,327	2,384
		Count Bal	99SL42X30BL	2,112	2,327	2,384





Squiracle with Thin Squiracle Disc Base	Top Size	Base	Model Number	3P	3K	3W
  Short Balanced Ht. Adjustable  Counter-balanced Ht. Adjustable  N/A  +72  N/A Thin disc bases:	24 x 24	Static	99SL24SD16	\$ 984	\$ 1,121	\$ 1,143
		Short Bal	99SL24SD16BLS	1,659	1,796	1,818
	30 x 30	Static	99SL30SD16	1,043	1,204	1,239
		Short Bal	99SL30SD16BLS	1,718	1,879	1,914
	36 x 36	Static	99SL36SD20	1,147	1,333	1,380
		Short Bal	99SL36SD20BLS	1,825	2,012	2,058
		Count Bal	99SL36SD20BL	1,825	2,012	2,058
	42 x 42	Static	99SL42SD26	1,371	1,585	1,642
		Short Bal	99SL42SD26BLS	2,024	2,239	2,296
		Count Bal	99SL42SD26BL	2,024	2,239	2,296

Square with X-base	Top Size	Base	Model Number	3P	3K	3W
  Short Balanced Ht. Adjustable  Counter-balanced Ht. Adjustable	24 x 24	Static	99SQ2424X22	\$ 630	\$ 678	\$ 766
		Short Bal	99SQ2424X22BLS	1,246	1,293	1,381
	30 x 30	Static	99SQ3030X26	698	771	872
		Short Bal	99SQ3030X26BLS	1,318	1,392	1,491
	36 x 36	Static	99SQ3636X30	869	974	1,081
		Short Bal	99SQ3636X30BLS	1,837	1,941	2,049
		Count Bal	99SQ3636X30BL	1,837	1,941	2,049
	42 x 42	Static	99SQ4242X34	982	1,123	1,235
		Short Bal	99SQ4242X34BLS	1,950	2,091	2,202
		Count Bal	99SQ4242X34BL	1,950	2,091	2,202

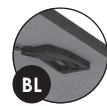
For Surge table options, please reference pages 196-199.

Top Size	Base	Model Number	3P	3K	3W	Square with Thin Square Disc Base
24 x 24	Static	99SQ2424QD16	\$ 761	\$ 809	\$ 897	    <p>Short Balanced Ht. Adjustable</p> <p>Counter-balanced Ht. Adjustable</p> <p>Thin disc bases: CH N/A SH +72 NU N/A</p>
	Short Bal	99SQ2424QD16BLS	1,439	1,486	1,574	
30 x 30	Static	99SQ3030QD16	826	898	999	
	Short Bal	99SQ3030QD16BLS	1,503	1,577	1,676	
36 x 36	Static	99SQ3636QD20	943	1,048	1,157	
	Short Bal	99SQ3636QD20BLS	1,622	1,728	1,835	
	Count Bal	99SQ3636QD20BL	1,622	1,728	1,835	
42 x 42	Static	99SQ4242QD26	1,169	1,311	1,422	
	Short Bal	99SQ4242QD26BLS	1,840	1,982	2,093	
	Count Bal	99SQ4242QD26BL	1,840	1,982	2,093	

Top Size	Base	Model Number	3P	3K	3W	Round with X-base
24 x 24	Static	99RD24X22	\$ 670	\$ 734	\$ 784	    <p>Short Balanced Ht. Adjustable</p> <p>Counter-balanced Ht. Adjustable</p>
	Short Bal	99RD24X22BLS	1,286	1,350	1,399	
30 x 30	Static	99RD30X26	761	859	908	
	Short Bal	99RD30X26BLS	1,380	1,480	1,528	
36 x 36	Static	99RD36X30	945	1,081	1,127	
	Short Bal	99RD36X30BLS	1,914	2,049	2,093	
	Count Bal	99RD36X30BL	1,914	2,049	2,093	
42 x 42	Static	99RD42X30	1,068	1,252	1,286	
	Short Bal	99RD42X30BLS	2,035	2,220	2,253	
	Count Bal	99RD42X30BL	2,035	2,220	2,253	
48 x 48	Static	99RD48X34	1,123	1,321	1,368	
	Short Bal	99RD48X34BLS	2,091	2,289	2,336	
	Count Bal	99RD48X34BL	2,091	2,289	2,336	

Top Size	Base	Model Number	3P	3K	3W	Round with thin Disc Base
24 x 24	Static	99RD24D20	\$ 801	\$ 865	\$ 914	    <p>Short Balanced Ht. Adjustable</p> <p>Counter-balanced Ht. Adjustable</p> <p>Thin disc bases: CH N/A SH +72 NU N/A</p>
	Short Bal	99RD24D20BLS	1,418	1,482	1,531	
30 x 30	Static	99RD30D20	888	986	1,035	
	Short Bal	99RD30D20BLS	1,506	1,604	1,652	
36 x 36	Static	99RD36D20	980	1,116	1,161	
	Short Bal	99RD36D20BLS	1,598	1,733	1,778	
	Count Bal	99RD36D20BL	1,598	1,733	1,778	
42 x 42	Static	99RD42D24	1,142	1,328	1,359	
	Short Bal	99RD42D24BLS	2,076	2,260	2,293	
	Count Bal	99RD42D24BL	2,076	2,260	2,293	
48 x 48	Static	99RD48D32	1,311	1,509	1,556	
	Short Bal	99RD48D32BLS	2,238	2,435	2,483	
	Count Bal	99RD48D32BL	2,238	2,435	2,483	

For Surge table options, please reference pages 196-199.

D-shaped with T-bases	Top Size	Base	Model Number	3P	3K	3W
 	24 x 36	Static	99D2436T22	\$ 845	\$ 938	\$ 1,010
		Nesting	99D2436T22NE	1,535	1,627	1,696
		Electric	99D2436T22EH	2,519	2,613	2,684
	24 x 48	Static	99D2448T22	922	1,047	1,127
		Nesting	99D2448T22NE	1,612	1,734	1,813
		Electric	99D2448T22EH	2,597	2,722	2,801
	24 x 60	Static	99D2460T22	1,001	1,158	1,245
		Nesting	99D2460T22NE	1,688	1,841	1,927
		Electric	99D2460T22EH	2,676	2,831	2,918
24 x 72	Static	99D2472T22	1,079	1,267	1,361	
	Nesting	99D2472T22NE	1,806	1,991	2,084	
	Electric	99D2472T22EH	2,753	2,940	3,035	
24 x 84	Static	99D2484T22	1,246	1,464	1,566	
	Nesting	99D2484T22NE	2,076	2,291	2,391	
24 x 90	Static	99D2490T22	1,285	1,519	1,625	
	Nesting	99D2490T22NE	2,114	2,344	2,448	
24 x 96 *	Static	99D2496T22	1,323	1,573	1,684	
	Nesting	99D2496T22NE	2,153	2,398	2,506	
30 x 48	Static	99D3048T26	1,008	1,165	1,233	
	Nesting	99D3048T26NE	1,696	1,850	1,916	
	Electric	99D3048T26EH	2,685	2,841	2,909	
30 x 60	Static	99D3060T26	1,107	1,301	1,373	
	Nesting	99D3060T26NE	1,793	1,983	2,053	
	Electric	99D3060T26EH	2,783	2,979	3,049	
30 x 72	Static	99D3072T26	1,205	1,439	1,510	
	Nesting	99D3072T26NE	1,930	2,159	2,231	
	Electric	99D3072T26EH	2,881	3,115	3,187	
30 x 84	Static	99D3084T26	1,390	1,665	1,737	
	Nesting	99D3084T26NE	2,218	2,487	2,558	
30 x 90	Static	99D3090T26	1,440	1,732	1,806	
30 x 96 *	Static	99D3096T26	1,488	1,800	1,877	
36 x 48	Static	99D3648T26	1,087	1,274	1,332	
	Nesting	99D3648T26NE	1,773	1,957	2,013	
	Electric	99D3648T26EH	2,763	2,951	3,008	

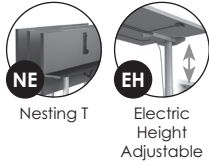

surge

* \$200 NET surcharge per order for oversized pallet

For Surge table options, please reference pages 196-199.

Top Size	Base	Model Number	3P	3K	3W	D-shaped with T-bases
36 x 60	Static	99D3660T26	\$1,205	\$1,439	\$1,491	
	Nesting	99D3660T26NE	1,978	2,208	2,260	
	Electric	99D3660T26EH	2,881	3,115	3,167	
36 x 72	Static	99D3672T26	1,321	1,603	1,651	
	Nesting	99D3672T26NE	2,211	2,486	2,534	
	Electric	99D3672T26EH	2,997	3,279	3,328	
36 x 84	Static	99D3684T26	1,527	1,856	1,901	
36 x 90	Static	99D3690T26	1,586	1,938	1,980	
36 x 96 *	Static	99D3696T26	1,645	2,020	2,061	

Top Size	Base	Model Number	3P	3K	3W	D-shaped with 2 Disc Bases
24 x 60	Static	99D2460D20	\$1,606	\$1,762	\$1,850	
24 x 72	Static	99D2472D20	1,685	1,872	1,967	
24 x 84	Static	99D2484D20	1,851	2,069	2,172	
24 x 90	Static	99D2490D20	1,889	2,125	2,231	
24 x 96 *	Static	99D2496D20	1,929	2,179	2,288	
30 x 60	Static	99D3060D20	1,705	1,900	1,969	
30 x 72	Static	99D3072D20	1,801	2,036	2,108	
30 x 84	Static	99D3084D20	1,988	2,261	2,335	
30 x 90	Static	99D3090D20	2,036	2,329	2,404	
30 x 96 *	Static	99D3096D20	2,085	2,398	2,473	
36 x 72	Static	99D3672D24	2,000	2,281	2,330	
36 x 84	Static	99D3684D24	2,205	2,533	2,578	
36 x 90	Static	99D3690D24	2,264	2,616	2,659	
36 x 96 *	Static	99D3696D24	2,323	2,698	2,739	
42 x 72	Static	99D4272D32	2,615	3,035	2,992	
42 x 84	Static	99D4284D32	2,737	3,168	3,147	
42 x 90	Static	99D4290D32	2,813	3,278	3,248	
42 x 96 *	Static	99D4296D32	2,891	3,386	3,349	

* \$200 NET surcharge per order for oversized pallet

For Surge table options, please reference pages 196-199.

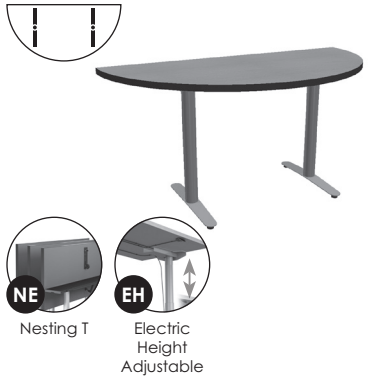
Half Round with T-bases	Top Size	Base	Model Number	3P	3K	3W
 <p>NE Nesting T</p> <p>EH Electric Height Adjustable</p>	30 x 60	Static	99HR3060T22	\$ 1,100	\$ 1,296	\$ 1,350
		Nesting	99HR3060T22NE	1,785	1,978	2,029
		Electric	99HR3060T22EH	2,775	2,971	3,023
	36 x 72	Static	99HR3672T26	1,320	1,601	1,630
		Nesting	99HR3672T26NE	2,133	2,409	2,438
		Electric	99HR3672T26EH	2,996	3,276	3,306

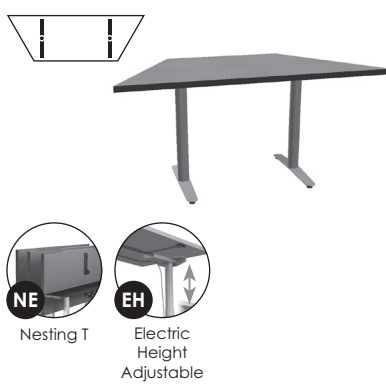
Trapezoid with T-bases	Top Size	Base	Model Number	3P	3K	3W
 <p>NE Nesting T</p> <p>EH Electric Height Adjustable</p>	30 x 60	Static	99TZ3060T22	\$ 1,048	\$ 1,224	\$ 1,292
		Nesting	99TZ3060T22NE	1,734	1,906	1,973
		Electric	99TZ3060T22EH	2,723	2,898	2,967
	36 x 72	Static	99TZ3672T26	1,292	1,562	1,600
		Nesting	99TZ3672T26NE	2,107	2,370	2,408
		Electric	99TZ3672T26EH	2,958	3,228	3,266

For Surge table options, please reference pages 196-199.