



table~~x~~



price list

Effective January 1, 2023





TableX Customer Service:
877.481.1177
sales@tablex.com

Welcome to our 2023 TableX price list. We have made a number of important product additions and several deletions to this most recent price book update. More table solutions are forthcoming, so please confirm you have the most current TableX product details and list prices by visiting: www.tablex.com/pricing.

If you have any questions, or need something above and beyond the standard solutions shown in this book, please don't hesitate to contact us. We welcome custom requests and are here to help you.

Introduction	Page
Pricing Comparison	p. 2
Terms & Conditions	p. 4
<ul style="list-style-type: none"> • Pricing • Orders • Order Acknowledgements • Terms • Lead Times • Modified Product • Cancellations & Returns 	
Freight	p. 5
<ul style="list-style-type: none"> • Freight Charges • Shipping 	
Sample Purchase Order	p. 6
Warranty	p. 7
Surface Materials	p. 8
<ul style="list-style-type: none"> • High Pressure Laminates • Powdercoat Base Colors • 3mm PVC Edges • 3mm PVC Knife Edges • Wood Edges (3mm only) • Coordinating Finishes 	
Table Options	p. 12
<ul style="list-style-type: none"> • Nesting Tables • Folding Tables • Flip Top Tables • Folding Tables • Top Options • Base Options • Custom Height Options • Height Adjustable Options 	
Seating Capacities	p. 20

Product Pricing	Page
TableXpress Quickship Program	p. 22
00 - Ultra Series	p. 28
01 - Foundation Series	p. 36
02 - Fundamental Series	p. 52
06 - Stretch Series	p. 68
08 - Elite Series	p. 84
09 - Revel Series	p. 102
17 - App Series	p. 106
33 - Element Series	p. 110
40 - Justice Series	p. 124
43 - Artisan Series	p. 132
44 - Primary Series	p. 138
45 - Puddle Series	p. 144
71 - Exclaim Series	p. 164
74 - VertiGo Series	p. 174
99 - Surge Series	p. 194
Table Accessories	p. 212
<ul style="list-style-type: none"> • Modesty Panels • Privacy Panels 	
Power / Data	p. 218
<ul style="list-style-type: none"> • Metal Pop-up Units • Budget Units • Daisylink Systems • Corded Systems 	
Wire Management	p. 226

24x60" Rectangles

Something as simple as a 24x60" rectangular table can be specified many different ways. With 12 different standard series of bases, TableX has you covered. Use the matrix below to compare list pricing of each series, using a static, 24x60" rectangular table with a 3P (3mm PVC) edge.



Ultra

p.32



\$1,050 List

Foundation

p.40

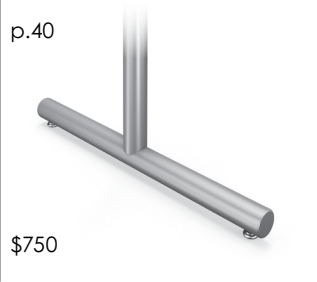

\$750

Fundamental

p.56

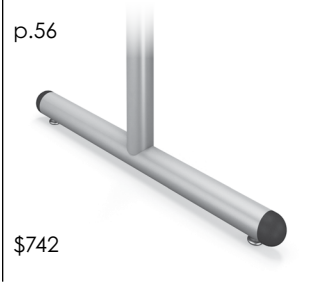

\$742

Stretch

p.72



\$800

Elite

p.88



\$952

Revel

p.105



\$927

Element

p.114



\$800

Justice

p.128



\$1,321

Artisan

p.136



\$1,610

Primary

p.136

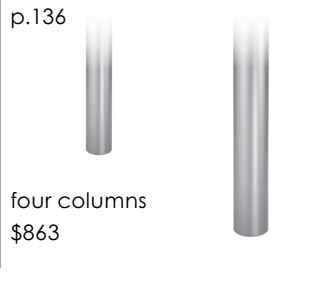

four columns
\$863

Primary

p.137

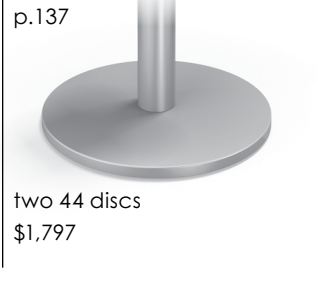

two 44 discs
\$1,797

Puddle

p.158



two 45 discs
\$1,551

Exclaim

p.164



\$1,073

VertiGo

p.181

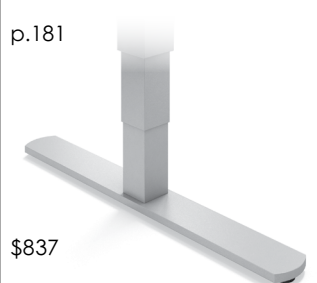

\$837

Surge

p.200

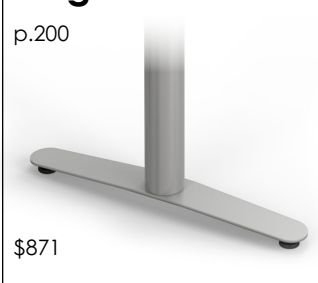

\$871

Surge

p.202

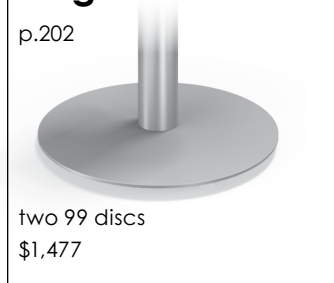

two 99 discs
\$1,477

36" Rounds

Cafe and lounge tables are being utilized everywhere. TableX offers a wide variety of bases that give you plenty of choices. Use the matrix below to compare list pricing of each series, using a static, 36" round table with a 3P (3mm PVC) edge.



<p>Foundation p.47</p> <p>\$783 List</p>	<p>Fundamental p.63</p> <p>\$744</p>	<p>Stretch p.79</p> <p>\$1,000</p>	<p>Elite p.97</p> <p>\$958</p>
<p>Element p.119</p> <p>\$964</p>	<p>Primary p.149</p> <p>four columns \$852</p>	<p>Primary p.149</p> <p>44 disc \$1,140</p>	<p>Puddle p.159</p> <p>45 disc \$1,017</p>
<p>VertiGo p.189</p> <p>\$1,006</p>	<p>VertiGo p.189</p> <p>74 disc \$1,021</p>	<p>Surge p.207</p> <p>\$945</p>	<p>Surge p.207</p> <p>99 disc \$980</p>

Pricing

All prices quoted are list prices, FOB our warehouse. All documentation and literature is based on the most recent information available at the time of this publication. We reserve the right to make product improvements and design enhancements at any time, without notice. Prices are subject to change without notification.

Orders

All orders must be received in writing with complete information. See page 6 for a sample purchase order and a checklist of information that is required to place an order.

E-mail orders to:
sales@tablex.com

Fax orders to:
812.481.1178

Duplicate orders that are not marked as such are the responsibility of the customer.

Order Acknowledgements

Orders are acknowledged upon receipt at TableX. No order shall be binding upon TableX until we confirm it with an acknowledgement. The customer bears sole responsibility for order correctness. All orders will be manufactured and invoiced in accordance with the acknowledgement. Customers must notify TableX in writing of any discrepancy **within 5 days**. Any subsequent change order is dependent upon our ability to accommodate the specification, terms and status of the order in production, and may be subject to additional charges for labor, material and other costs involved.

Terms

Terms are Net 30 days from the date of invoice. Payment is due when invoice is issued and is considered delinquent if not paid within 30 days. Interest will be charged at the rate of 1.5% per month on delinquent accounts. TableX does not create or provide statements.

Lead Times

Lead times can vary based on product availability, fluctuations in busy season, and national holidays. Please contact customer service at 877.481.1177 for current lead times.

Note: Selecting certain options (3mm wood edges, chrome bases, or solid surface tops) can impact lead time. Below are estimated lead times based on normal business conditions.

Laminate	Edge	Base	Standard Lead Time
<i>TableXpress Program</i>			<i>7-10 day quickship</i>
standard	3mm PVC	standard	4-5 weeks
solid surface tops			4-6 weeks
3mm wood			6-8 weeks
chrome			8 weeks

Modified Product

TableX prides itself on providing you with product that exceeds your expectations. Sometimes your needs are outside the standard product offering. Our flexibility as a smaller company allows us to accommodate requests for non-cataloged product. Contact Customer Service at 877.481.1177 to discuss your unique product requirements and we'll help you meet your needs.

Cancellations & Returns

Our acceptance of an order is final and binding and not subject to cancellation by the customer. No merchandise may be returned without the written consent of TableX. When ordering electrical components on pages 228-235, it is the responsibility of the customer to ensure the components selected meet local electrical codes. Electrical components are made-to-order and cannot be returned.

Freight Charges

TableX is located in Jasper, Indiana. All shipping zones are based on proximity to our facility.

Minimum Orders

Standard freight charges apply to any order under \$3,000 total list price shipping within the continental United States. The standard charge for each zone is shown below, based on the total list price of the order.

Tiered Freight Program

These freight charges are reduced or waived on orders based on their total list price. The qualifying list prices for each zone are shown below.

Shipping

All shipments are F.O.B., dock-to-dock from our warehouse. Charges for additional services such as lift gates, non-commercial deliveries, inside deliveries, oversized pallets (pallets used for single table tops 96" or longer), and call before delivery are the responsibility of the buyer and may be charged to the buyer after the date of delivery.

Legal responsibility for the product transfers to the buyer upon acceptance by the carrier. Damaged, lost or shorted shipments are the responsibility of the carrier. Inspect all shipments promptly upon arrival and note any damage or loss on the delivery receipt. If damage is concealed, keep the packing and notify the carrier immediately for an inspection. Carriers require such reports within 5 days of delivery. Failure to report damage or loss is the consignee's responsibility. The freight charges may be collect to the receiver, billed to the purchaser, or prepaid by TableX.

Freight Claims

Legal title to merchandise passes to the buyer upon acceptance by the carrier. All cartons must be carefully inspected upon delivery for visible and concealed damage. If concealed damage has occurred, the carrier must be notified within (5) days. All of our product is thoroughly inspected before it leaves the factory, therefore it is the buyer's responsibility to seek recourse against the carrier.

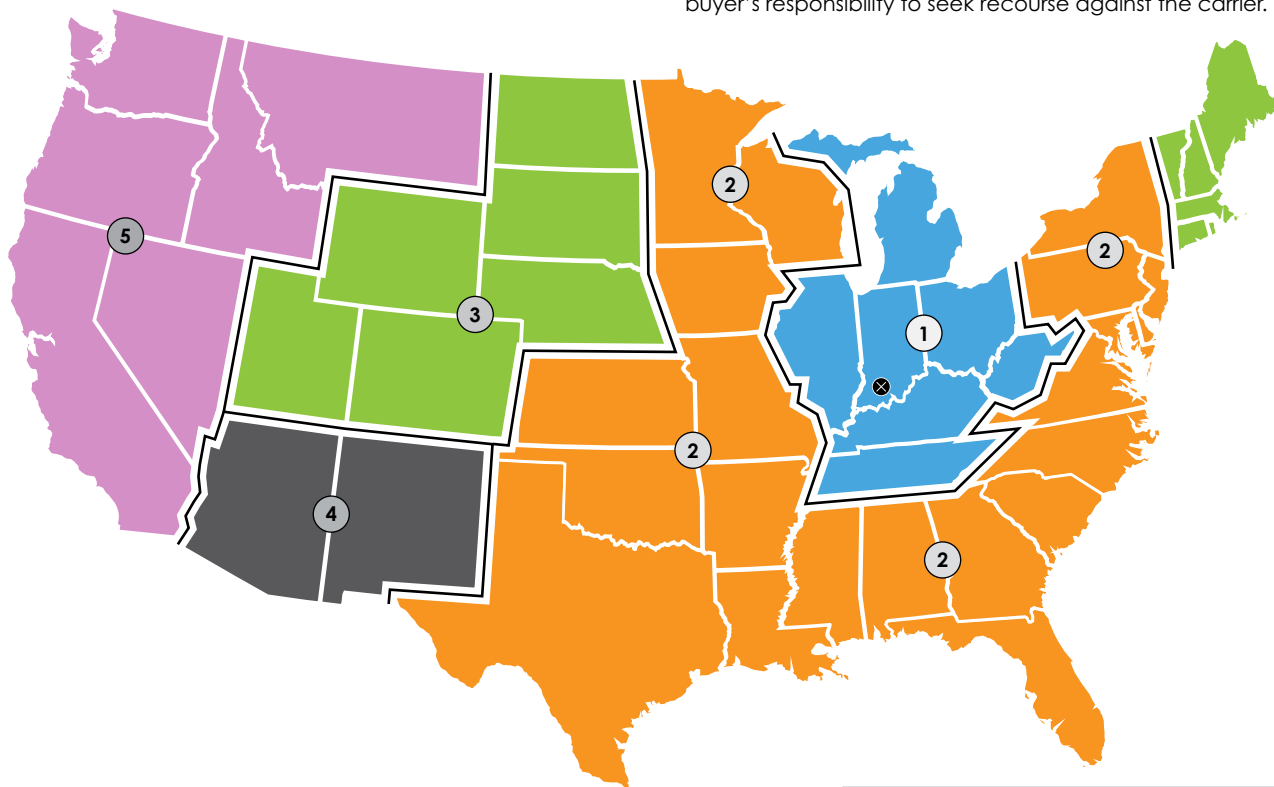

Zone	Destination State	Total List Price / Freight Charge				
		< \$3K	> \$3K	> \$5K	> \$7.5K	> \$10K
1	IL, IN, KY, MI, OH, TN, WV	\$150	free freight			
2	AL, AR, DE, FL, GA, IA, KS, LA, MD, MN, MO, MS, NC, NJ, NY, OK, PA, SC, TX, VA, WI	\$250	\$150	free freight		
3	CO, CT, MA, ME, ND, NE, NH, RI, SD, UT, VT, WY	\$300	\$250	\$150	free freight	
4	AZ, NM	\$350	\$300	\$250	\$150	free
5	CA, ID, MT, NV, OR, WA	freight charge must be quoted				

Email orders to:
sales@tablex.com

Fax orders to:
812.481.1178

When sending in a purchase order, please be sure to include the following items. Each of these is important to ensure that your order is processed accurately and in a timely manner.



Furniture Dealer
123 Main St.
Middletown, US 12345

ph. 123.456.7890
fax 123.456.7890

PURCHASE ORDER

page 1 of 1

PO #	Date
12-34567-89	01 / 03 / 2023

TO: TableX
555 Cathy Lane
Jasper, IN 47546

SHIP TO: Furniture Dealer
123 Main St.
Middletown, US 12345

Line	Quantity	Model # / Description	Unit Price	Ext. Price
		Special Instructions: Call 24 hours before delivery: James Abbott, 123.456.7890 Dealer contact: Peter Gray, 123.456.7890		
1	12	01TC2460T22NE-3P-GR.A - 7960K-18/3021/37 Foundation 24x60" rectangular table with 22" wide T-bases. NE: nesting with locking casters GR.A: 1 grommet in location A List Price: \$1,487 Discount: 50/10 Laminate: Wilsonart 7960K-18 Studio Teak 3P: 3MM EDGE: 3021 Espresso BASE: 37 Satin Silver TAG: training room	669.15	8,029.80
2	5	08RD48X36-3W - 7054-60/NG/21 Elite 48" round table with 36" wide X-base. List Price: \$1,377 Discount: 50/10 Laminate: Wilsonart 7054-60 Wild Cherry 3mm Wood - NG-Nutmeg BASE: 21 Silver Frost TAG: break room	619.65	3,098.25
Freight			0.00	0.00
Total order amount				11,128.05

Your PO #

We will include this on your order acknowledgement for easy tracking.

'Ship To' Address

Check page 5 to see how location will affect freight charges.

Special Instructions

This includes but is not limited to a requested delivery date, call before delivery, dealer contact, and tagging instructions.

Complete Model #

include any options and your surface materials.

List Price & Discount

This is important so that we can double check any options and upcharges.

Surface Materials

Double check to make sure these are included. this is the piece most often left off of a PO.

Freight Charges

Many larger orders qualify for free freight. reference the chart on page 5 to verify your costs.

Line Item #

Makes cross referencing much easier if we have any questions.

Quantity

Exactly how many of these do you need?

Product Tagging

We will include this on the label underneath each table.



Warranty

Effective April 15, 2020

TableX merchandise limited warranty on the original purchase covers normal use for 50 years from date of shipment against defect regarding workmanship and materials.

Electrical components are covered for 1 year. Moving components; such as, but not exclusive to; casters, flip top mechanisms and height adjustment mechanisms are covered for 5 years. Note of exception on Nesting Extrusions, warranty is 10 years.

Formica, Wilsonart, Pionite, and Nevamar laminates are covered by the specified surface manufacturer under their particular warranty only. TableX does not promote laminate "self edge" tops due to their tendency to be damaged during everyday use. Self edge and butcher block tops are done by special request only and are covered for 1 year.

Finishes, when exposed to ultraviolet rays, may change color. Desktop accessories with rubber or plastic feet can penetrate or burn a finish. These issues are not warranted and will not be the responsibility of TableX.

- Exclusions include:**
- Normal wear and tear over course of ownership or abuse beyond originally intended use of product.
 - Modifications or additions to the product, or final product assembly that is not TableX approved.
 - Product used for rental purposes
 - Damage caused by misapplication of cleaning chemicals or improper use of core and cleaning procedures.
 - Surface materials damaged by excessive humidity or dryness in an uncontrolled environment.

When ordering tops or bases ONLY; TableX will not be held liable for any tops or bases used in conjunction with any other manufacturer's products.

Any repairs or modifications by the customer must receive specific written authorization from TableX prior to being executed, or warranty may be voided.

In no event shall liability under this warranty exceed the original purchase price of the product.

All TableX products are tested to meet or exceed BIFMA standards.

High Pressure Laminates

Standard Laminates

TableX stocks over 40 laminates. With a large selection of patterns, solids, and woodgrains, these laminates are all available at standard pricing.

Special Laminates

TableX also offers Wilsonart, Nevamar, Pionite, and Formica laminates. Please contact customer service to confirm pricing and availability of any non-standard laminates.

TableXpress Quickship Program

When ordering TableXpress quickship products, you must select from our standard list of stocked laminates.

Samples

Laminate samples are available by request. Scans of these laminates are also available on tablex.com for reference, but because of variations in monitor and printer calibration we do not suggest specifying without seeing a physical sample.

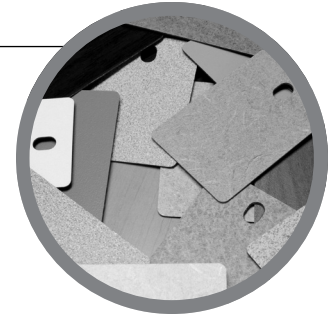

Pattern Laminates		Solid Laminates		Woodgrain Laminates	
299-58	Ebony Oxide	D96-60	Shadow*	7054-60	Wild Cherry *
4621-60	White Nebula*	D315-60	Platinum*	7122K-07	Empire Mahogany *
4622-60	Grey Nebula	D354-60	Designer White*	7933K-07	Cafelle *
4623-60	Graphite Nebula*	D355-60	Gunmetal*	7943K-07	Colombian Walnut *
4656-60	Bronze Legacy*	D439-60	Wallaby*	7946-38	Brazilwood *
4668-60	Mushroom Tigris	1500-60	Grey*	7960K-18	Studio Teak *
4779-60	Pewter Brush	1573-60	Frosty White*	7965K-12	Walnut Heights *
4783-60	White Tigris*	1595-60	Black*	10776-60	Kensington Maple *
4810-60	Titanium Ev*	D91-60	Slate Gray*		
4811-60	Silicon Ev	D381-60	Fashion Grey*		
4813-60	Nickel Ev	D431-60	Alabaster		
4814-60	Tungsten Ev*	899-58	Desert Beige		
4820-60	Carbon Ev*	928-58	Mouse		
4841-60	Desert Zephyr	7197-58	Dover White		
4842-60	Canyon Zephyr	8751-58	Mojave		
4843-60	Misted Zephyr				
4844-60	Loden Zephyr				
4846-60	Morro Zephyr				
4876-38	Sheer Mesh				
4879-38	Steel Mesh				
4942-38	Crisp Linen				
6220-58	Smoke Quarstone				
6729-58	Paloma Bisque				
7708-58	Flax Gauze				
8830-58	Elemental Concrete				

* Matching standard 3mm edge available.

Powdercoat Base Colors

Standard Powdercoat Finishes

TableX offers over 30 different powdercoat finishes. Most product lines are available in the full offering of powdercoat colors. Check the series intro for any product specific limitations.

Chrome

Chrome is available on several of our table lines for a standard upcharge per table. Please check the series intro for availability. Also note that chrome bases add 4 weeks to the standard leadtime.

Samples

Paint samples are available by request. Scans of these paint colors are also available on tablex.com for reference, but because of variations in monitor and printer calibration we do not suggest specifying without seeing a physical sample.

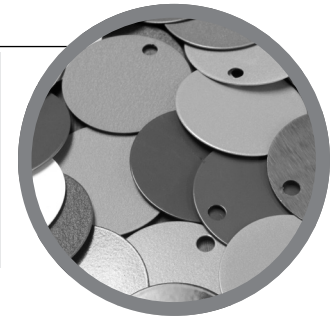

Standard Powdercoat Finishes

01	Structured Black	37	Satin Silver	49	Dolphin
02	Black	39	Poppy	50	Cannon
05	Structured Slate	40	Rosey	51	Glitz
17	Creme	41	Scarlet	53	Fawn
21	Silver Frost	42	Kiwi	54	Nickel
23	Phantom	43	Kale	55	Pewter
24	Linen	44	Evergreen	56	Kona
25	Storm	45	Horizon	57	Jet
29	Flint	46	Lagoon	58	Cinder
30	Pearl	47	Moonlight	59	Bronze
35	Sand	48	Arctic		

Premium Finishes

CH	Chrome
----	--------

Height Adjustable Finishes

21	Silver Frost	40	Rosey	47	Moonlight
25	Storm	41	Scarlet	55	Pewter
29	Flint	42	Kiwi	56	Kona
30	Pearl	43	Kale	57	Jet
35	Sand	44	Evergreen	59	Bronze
37	Satin Silver	45	Horizon		
39	Poppy	46	Lagoon		

Note

Counterbalance height adjustable tables are only available in 30 Pearl, 57 Jet, or 37 Satin Silver. Electric height adjustable tables are only available in 57 Jet or 37 Satin Silver.

3mm PVC Edges

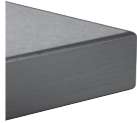

3P
Flat

Standard Edges

TableX stocks 9 solid edge colors and 18 woodgrain edges. Seven of those woodgrain edges are also available as a reeded edge.

TableXpress Quickship Program: When ordering TableXpress quickship products, you must select from our standard list of 3mm PVC edges. Knife edge is not available.

Samples

Edge samples are available by request. Scans of these edges are also available on Tablex.com for reference, but because of variations in monitor and printer calibration we do not suggest specifying without seeing a physical sample.



3P
Reed

Solid 3mm PVC Edges

001	Medium Grey *
015	Charcoal *
016	Haze *
D354	Designer White *
1096	Pepperdust
480	Antique White *
2416	Black *
3020	Iron Alloy
7044	Foundry

Woodgrain PVC Edges

TX093	Amaretto Maple	FTX087	Coastal Maple
TX095	Bramble Walnut	FTX089	Colombian Walnut *
TX098	Dusk Walnut	F3022	Warm Cherry
TX103	Walnut Heights *	F3023	Empire Mahogany *
TX104	Studio Teak *	F3024	Traditional Cherry
TX108	Cashew Rift	F3025-2	Blonde Maple 2
TX109	Chestnut Rift	F3026	Cafelle *
TX110	Ashen Rift		
7054	Wild Cherry *		
7946	Brazilwood		
10776	Kensington Maple *		

Woodgrain Reed Edges

RTX087	Coastal Maple
RTX089	Colombian Walnut *
R3022	Warm Cherry
R3023	Empire Mahogany *
R3024	Traditional Cherry
R3025-2	Blonde Maple 2
R3026	Cafelle *

* Matching standard laminate available.

3mm PVC Knife Edges



3K
Knife

Knife Edges

Any standard 3mm edge is available as a knife edge. Simply specify the 3mm edge and also specify the paint color for the angled MDF core. There are six colors available. Each is based on a Wilsonart solid laminate color of the same name.

PVC Knife Edges Core Colors

K91	Slate Grey
K315	Platinum
K354	Designer White
K439	Wallaby
K495	Coffee Bean
K1595	Black



2P
Acrylic

2mm 3D Acrylic Edges

3D Acrylic Edges

For uses in especially high traffic areas that are prone to impact. 2mm acrylic is designed to be long-lasting and resistant to impact and scratches. Provides a metal edge 'look' without the denting of real metal. **5% upcharge for this edge option.**

Acrylic Edge Options

3DT	3D Titanium
3DA	3D Aluminum

Wood Edges

Please check top shape for availability. Also note that 3mm wood edges add 2-4 weeks to the standard leadtime.

TableXpress

Wood edged tops are not available on our TableXpress Quickship Program.

Care & Maintenance

Clean all surfaces with water-dampened soft cloth in the direction of the grain. Quickly buff dry.

Immediately remove any liquids that come in contact with the wood surfaces using a blotting action to absorb the liquid. Lift objects to move them. Never pull them across the finished surface.

Avoid exposing furniture to extreme heat and cold or to wide humidity variances. Avoid exposing furniture to strong sunlight. Exposure to sunlight over time will cause finish variation. Do not use soaps, commercial cleaners or harsh solvents as they will cause finish deterioration. If using a protective glass top, place spacer pads under the glass top to allow the wood to breathe.

3W
Flat



Samples

Wood finish samples are available by request. Scans of these finishes are also available on tablex.com for reference, but because of variations in monitor and printer calibration we do not suggest specifying without seeing a physical sample.

Wood Edge Finishes					
AD	Almond	CI	Cocoa Infusion	NG	Nutmeg
BH	Butterscotch	CT	Chestnut	SE	Spice
BV	Black Velvet				

Coordinating Solid Finishes

Standard Base Colors		Solid Laminates		Solid 3mm PVC Edges		PVC Knife Edges Colors	
02	Black	1595-60	Black	2416	Black	K1595	Black
23	Phantom			3018	Shark	K91	Slate Grey
24	Linen			354	Designer White	K354	Designer White
35	Sand			1096	Pepperdust		
		1572-60	Antique White	1572	Antique White		

Coordinating Woodgrain Finishes

Woodgrain Laminates		Woodgrain PVC Edges		Reed Woodgrain PVC Edges	
7122K-07	Empire Mahogany	F3023	Empire Mahogany	R3023	Empire Mahogany
10776-60	Kensington Maple	10776	Kensington Maple		
7933K-07	Cafelle	F3026	Cafelle	R3026	Cafelle
7943-07	Colombian Walnut	FTX089	Colombian Walnut	RTX089	Colombian Walnut
7054-60	Wild Cherry	7054-60	Wild Cherry		
7946-60	Brazilwood	7946-60	Brazilwood		
7965K-12	Walnut Heights	TX103	Walnut Heights		
7960K-18	Studio Teak	TX104	Studio Teak		

Nesting T-bases

Rectangular and half-round tables nest and stow with ease. These tables are noted in the pricer by an "NE" at the end of the model number.

Top sizes and shapes vary slightly by series. Rectangular nesting tables larger than 30x66" use a two-handed release.

Locking casters

All nesting T-base models are already priced to include 2" locking casters.

Offset bases not available on 18"d nesting tables.

Staggered Nesting Dimensions

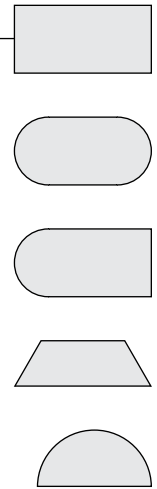
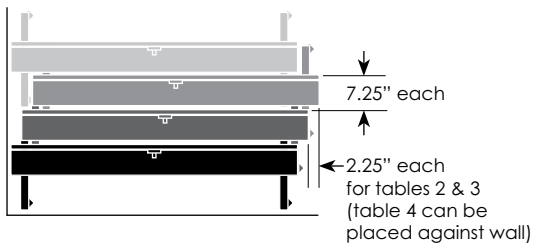

00 - Ultra	01 - Foundation	02 - Fundamental	06 - Stretch	08 - Elite	09 - Revel	33 - Element	44 - Primary	45 - Puddle	71 - Exclaim	74 - VeriGo	99 - Surge
------------	-----------------	------------------	--------------	------------	------------	--------------	--------------	-------------	--------------	-------------	------------

Nesting Options											
Nesting T	•	•	•	•	•	•				•	•

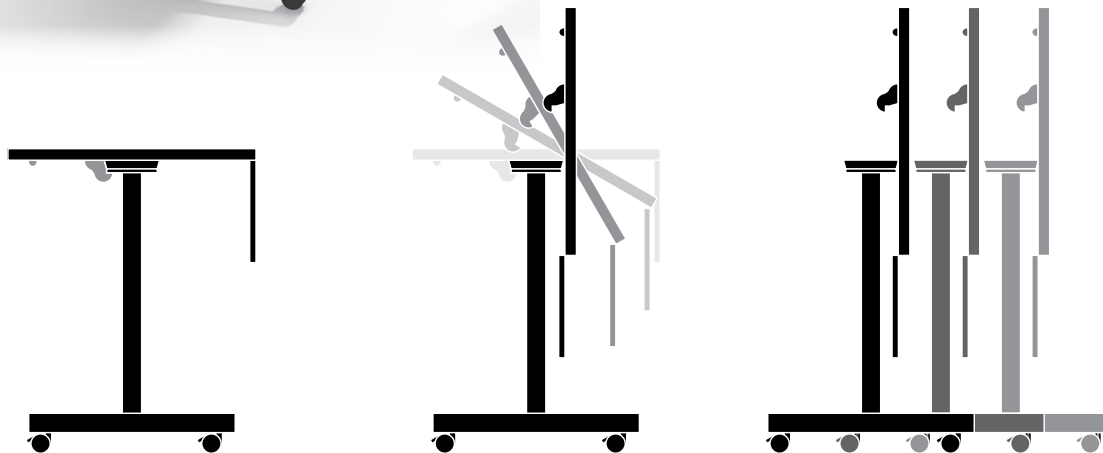

Nesting TT-bases

Large square and round tables don't have to be cumbersome. These tables become easily mobile using our two-handed TT nesting. These tables are noted in the pricer by an "NE" at the end of the model number.

This mechanism is used on 60" & 54" rounds, 48" squares, and 42x60" - 48x72" rectangles & D-shapes. Availability varies slightly by base series.

Locking casters

All nesting TT-base models are already priced to include 3" locking casters.

Staggered Nesting Dimensions

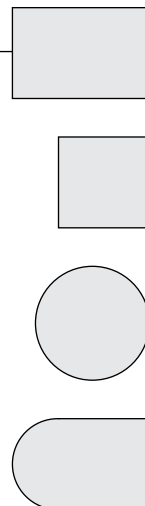
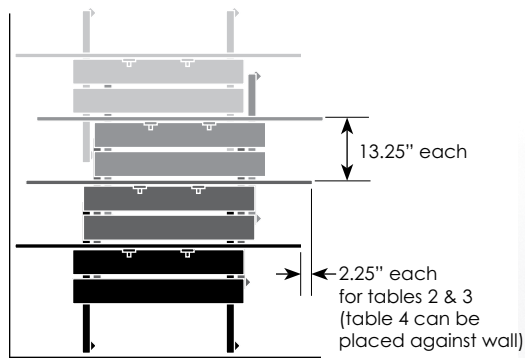

	00 - Ultra	01 - Foundation	02 - Fundamental	06 - Stretch	08 - Elite	33 - Element	44 - Primary	45 - Puddle	71 - Exclaim	74 - VeriGo	99 - Surge
Nesting Options											
Nesting TT	•	•	•	•	•					•	

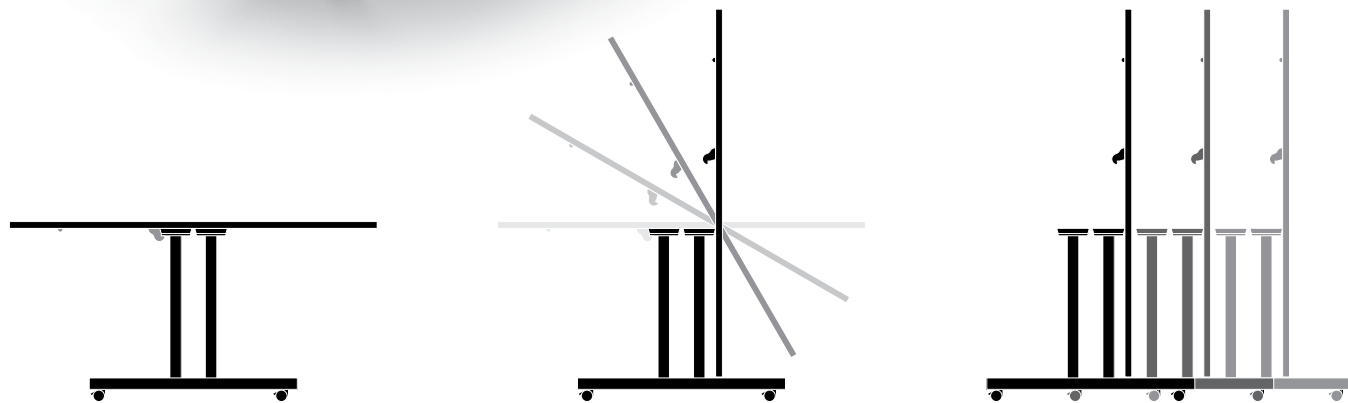

Flip Top X-bases and H-bases

Flip top tables can be a great space saver. These tables are noted in the pricer by an "FT" at the end of the model number.

Round & Square

Availability varies by series. Other options, such as casters, may dictate which sizes are available.

Rectangle & Kidney Bean

Available on VertiGo series H-based tables.



Nesting Options	
00 - Ultra	
01 - Foundation	•
02 - Fundamental	•
06 - Stretch	•
08 - Elite	•
33 - Element	
44 - Primary	
45 - Puddle	
71 - Exclaim	
74 - VertiGo	•
99 - Surge	•

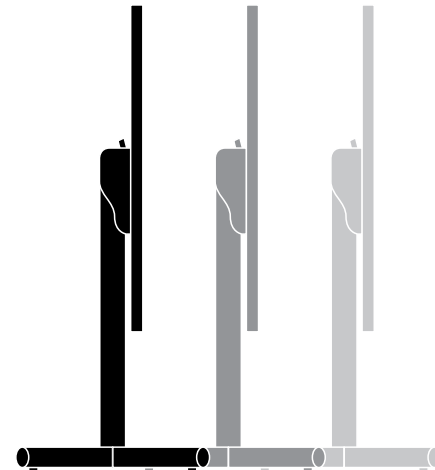
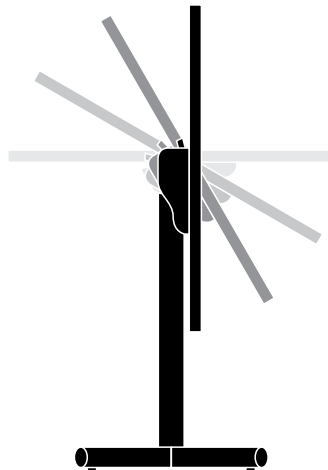
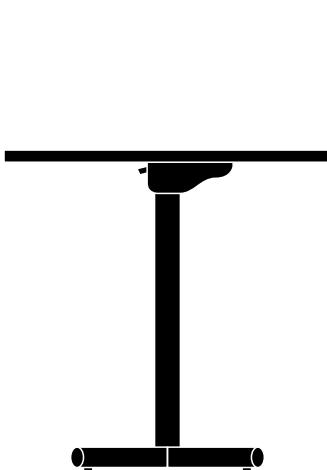

Folding T-bases and TT-bases

Rectangular, racetrack, and some round tables fold for easy storage. These tables are noted in the pricer by an "FD" at the end of the model number.

Standard Folding

Racetrack and rectangular tables 60" and longer use two standard folding mechanisms. Bases fold toward each other and end up toe-to-toe for a total thickness of 4.75" per table.

Short Folding

All round tables and any rectangular tables 48" long or less use a short fold mechanism. Bases fold one over the other for a total thickness of 6.75" per table.

Storage Table Carts

Carts to help store and move tables are available. See pricing below.

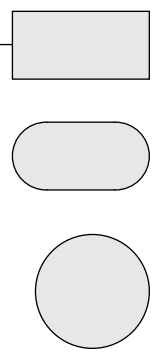
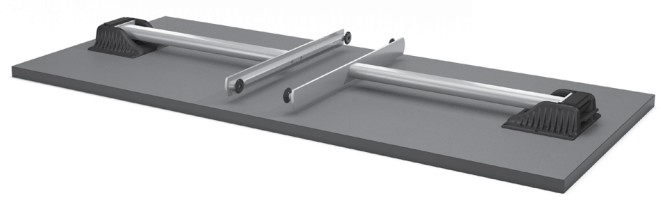

	00 - Ultra	01 - Foundation	02 - Fundamental	06 - Stretch	08 - Elite	33 - Element	44 - Primary	45 - Puddle	71 - Exclaim	74 - VerfiGo	99 - Surge
Folding Options											
Folding T	•	•	•	•	•	•					•
Folding TT	•	•	•	•	•	•					

Standard Folding

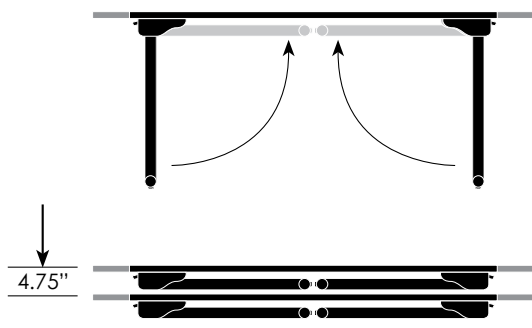

Short Folding

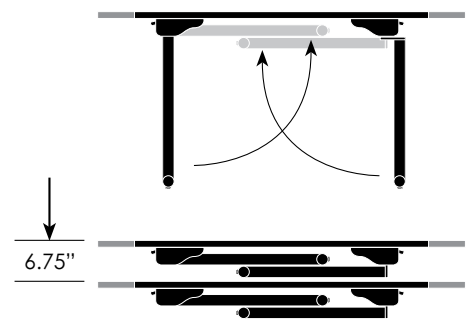

Folding Table Carts

Table Shape	Max Table	Capacity	Model Number	Finish	Price	Mobile Carts
Round	60"	Four short-fold tables	STC-RD60	01 Structured Black	\$ 1,690	
Rectangle	30 x 60"	Six folding tables	STC-TC60	01 Structured Black	1,683	
	30 x 72"	Six folding tables	STC-TC72	01 Structured Black	1,873	
	30 x 84"	Six folding tables	STC-TC84	01 Structured Black	1,903	
	30 x 96 **	Six folding tables	STC-TC96	01 Structured Black	2,045	

RC 3" Radius Corners

3" radius corners soften the corner of tables to give them a smooth feel. Upcharge is \$61 per table.

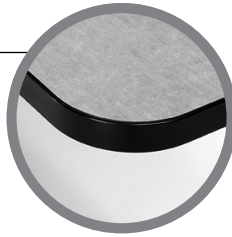

MARKER Markerboard Laminates

White markerboard laminate can be specified on any table for an upcharge of \$111 per table. We suggest pairing this with a dark 3mm edge. Call customer service for custom quotes on other markerboard laminates.



GR Grommets

Grommets can be added to most table shapes for an upcharge of \$45 each. Simply add "-GR" to your model number. 60 mm radius hole. Available in black. See page 227 for location details.

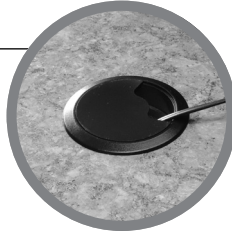

MP Modesty & Privacy Panels

Modesty & privacy panels can be added to many table sizes, and some can also be used on folding and nesting models.

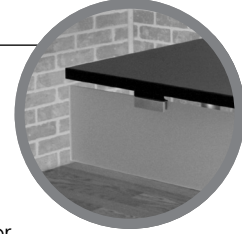

Available in laminate, metal, frosted acrylic, and mesh. See pages 204-207 for complete selection and pricing.

SOLID Solid Surface Tops

Need something a little more substantial? We can offer solid surface tops on many of our tables. These are quite popular on disc and X-based cafe tables. Call customer service for a custom quote. Leadtime on solid surface is usually around 6 weeks.

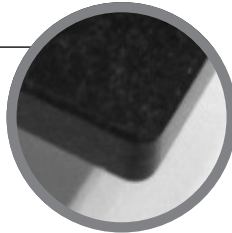

LOGO Custom Logo Tops

Make your laminate table top the focal point of any room by adding your logo in full color. Working with Wilsonart, we can add logos that utilize standard laminates into the background and integrate them into the logos themselves.



This process requires a custom quote, and does require an extended leadtime, but the final results are worth it.

QG Quick-Connect Ganging Brackets

Easily connect and disconnect tables or tables of any shape for simple room configurations. Quick to install and built to last, these table connectors will provide clients with durability and functionality for years to come. These allow for seamless assembly and handling with a low profile design. Upcharge is \$45 (includes 4 connectors per table).



LC Locking Casters

2" locking casters can be added to most tables for an upcharge of \$111 per set of four. Check product details for availability.

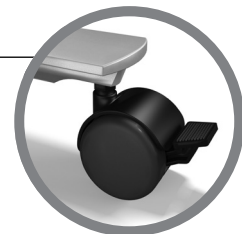

Note: nesting tables are priced with locking casters included.

PHK Bag Hooks

Accessory hooks are great for hanging coats and purses. This is a simple add on item that works on practically any table. \$12 list each.

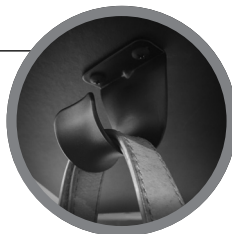

CCG Concealed Casters

Concealed casters can be specified on one side of a T-based table. Other side will have standard glides. Overall height remains at 29". Upcharge is \$137 per table.

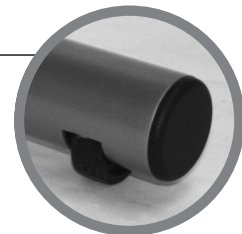

Only available on Foundation, Fundamental, & Element series. (Foundation uses black end cap as pictured.)

OS Offset T-bases

Most T-bases can be upgraded to offset T-bases. The standard offset is 3". Check product details for availability. Upcharges vary based on series.

Not available on any 18"d tables.
Not available on 30"d nesting tables less than 60" wide.

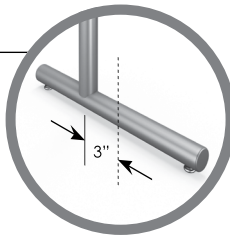

WM/VC Snap-on Wire Management Leg Cover

Snaps on to round columns and offers coverage of wires down the leg. Powdercoated steel to match base color. Check series details for compatibility. Upcharge is \$50 for 2" and \$79 for 3" (Surge & Puddle Series). See page 226 for details. Not available in chrome.

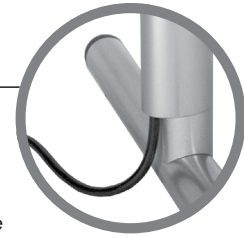

EM Edge Mounted T-bases

T-bases and TT-bases can be specified as edge mounted bases on most static models for \$76. Bases on tables 36-48" in length are already edge mounted.

The position of bases on folding and nesting tables cannot be adjusted.

Table Length	EM
36-48"	standard
60-96"	\$76

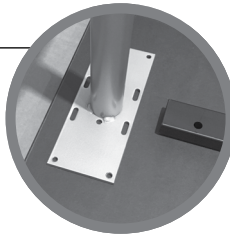

MM/VC Magnetic Wire Management Leg Cover

Magnetically attaches to rectangular and square columns and offers coverage of wires down the leg. Powdercoated steel to match base color. Check series details for compatibility. Upcharge is \$71 each. See page 226 for details.

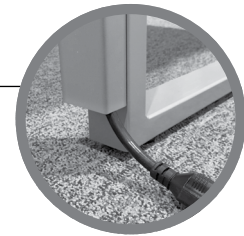

CH Chrome Finish

Chrome finish is a premium finish available on select models. Check product details for availability. Upcharges vary based on series and number of bases.

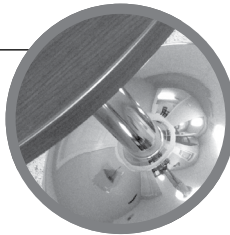

PB Powerbox Mounting Plate

The powerbox is ideal for round and square tables that have a power unit centered in the top. This U-shaped mounting plate allows 2.75x8x12" for the unit itself, wire management through the column, and a hole out the side and bottom of the column. Available on most X-bases and disc bases for \$100 upcharge. \$132 list upcharge on BWE - Bottom Cord Exit on 44 or 99 disc bases.

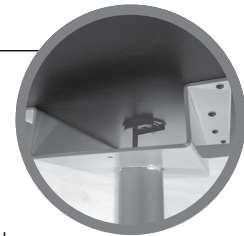

FM/LB Floor Mount Leveler Brackets

These brackets are available only as an add-on to our bases and are not for individual sale. Floor mounting hardware not included. Upcharge is \$100 per table.

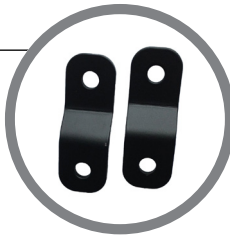

BWE Bottom Cord Exit

Wires are slipped through the column from the mounting plate to the floor. Only available on 44 or 99 disc bases. Upcharge is \$132.

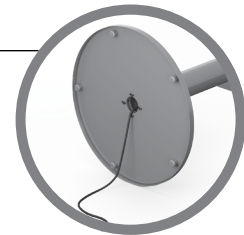

WM Built-in Wire Management

One of two T-bases will have a 1x19" steel access door with self closing hinges. Door height can vary depending on other specified options. Check series details for availability. Upcharge is \$139 per column. See page 226 for details. Not available in chrome.



SH Special Height

Special height tables can be specified in most series. Standard height is 29". Upcharges vary based on base and height needed.

Tables larger than 36x72" will need a stretcher bar between the bases. Contact customer service to quote these tables.

When specifying, include your custom height in the model number. For example: (-SH.42) for special height of 42".

Upcharges vary based on base and height needed, see individual series for pricing.

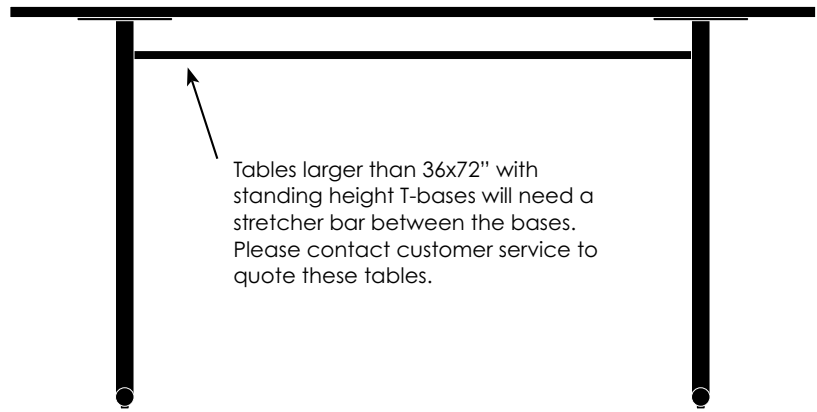
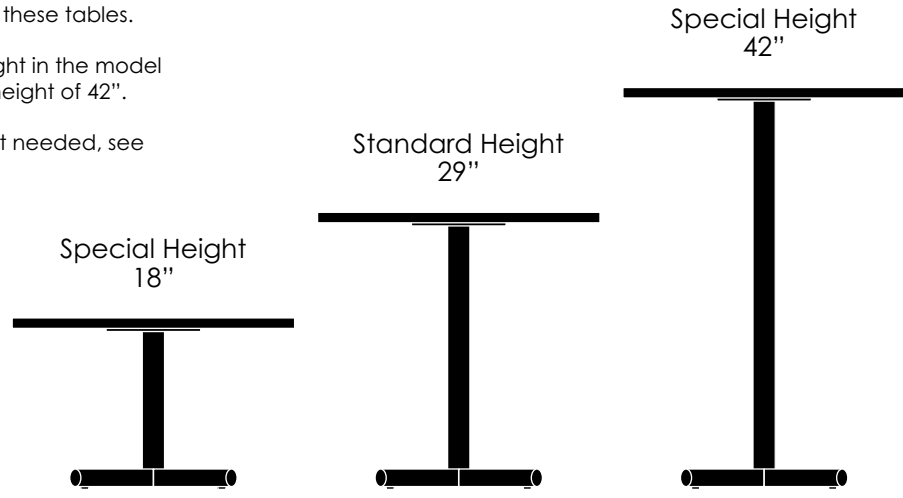

Tables larger than 36x72" with standing height T-bases will need a stretcher bar between the bases. Please contact customer service to quote these tables.

FR Footring

A footring is available on disc bases and select X-bases that are at standing height. Check product details for availability. Upcharge is \$166 per base. Not available in chrome.

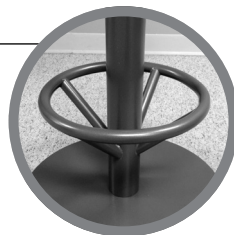



	00 - Ultra	01 - Foundation	02 - Fundamental	06 - Stretch	08 - Elite	33 - Element	44 - Primary	45 - Puddle	71 - Exclaim	74 - VeriGo	99 - Surge
--	------------	-----------------	------------------	--------------	------------	--------------	--------------	-------------	--------------	-------------	------------

Height Adjustable Options											
Spring Clip		•	•	•	•		•	•			
Ratchet		•	•							•	
Counterbal.							•	•		•	•
Short Bal.							•	•		•	•
Pneumatic		•	•				•	•			
Hand Crank										•	
Electric										•	•
Man. Ext. Ht.		•	•				•				

EH Electric Height

Electric height adjustability gives you the height range of the counterbalanced option, but is available in a wider variety of top shapes and sizes. The memory keypad remembers your four favorite heights. Available in both VeriGo and Surge.

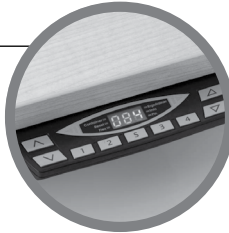

EX Manual Extended Height

This base has the ability to manually change height in 1" increments by removing and re-inserting its bolts. Table height range of 26-42". Available in Foundation (T-bases), Fundamental (T-bases), and Primary series (2" column only).

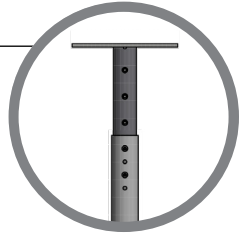

BL Counterbalanced

Need to get the most out of your height adjustable tables? The counterbalanced option is the way to go. Simply squeeze the small handle underneath and gently move the top to your desired height. With a range over 17" and unlimited choices in between, it's just that easy.

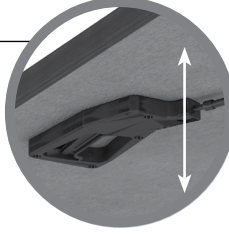

BLS Short Balanced

Go from coffee table height to standard height with the Short Balanced. Simply squeeze the small handle underneath and gently move the top to your desired height. Approximately 18-29".

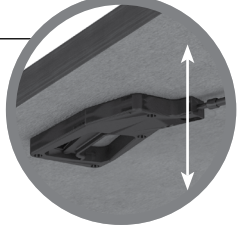

CR Hand Crank

Need the flexibility of infinite adjustability without the budget for counterbalanced bases? Our manual hand crank offers a cost-effective alternative. Only available in the VeriGo series and available on some nesting models.

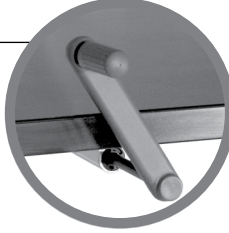

NU Pneumatic

Most square (max 36") and round (max 42") tables are available with pneumatic height adjustability. 12" range in 1" increments. Upcharge is \$387 on X and disc bases. Also available on select T-bases in Foundation & Fundamental for \$772, including some nesting models.

Base	NU
X-base	\$387
T-base	\$772

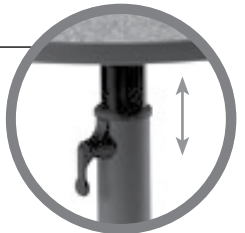

RA Ratchet

Ratchet height adjustability is available on select VeriGo, Foundation, & Fundamental tables. With a range of 9.45," the ratchet works in thirteen increments of .78". To reset to the lowest position, just lift past its highest point. Ratchet height adjustable bases are also available on some nesting tables.

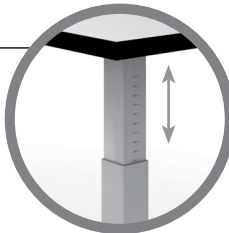

AH Spring Clip

A spring clip height adjustment mechanism is available on most tubular bases. See each series for availability. Height adjustment range is 26-32". Not available on tables larger than 42" round or 36" square.

Base	AH
X-base	\$139
T-base	\$277
4 columns	\$555

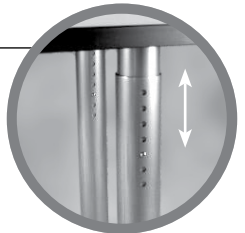

General Guidelines for Seating Capacities

- Allow about 30"/person
- Allow 48" for aisles between tables. ADA has 36" min.
- Allow 96"-120" between presenter and front row.
- Rooms with only one entrance are restricted to accommodate a maximum of 50 people (per fire code).
- Space required for single wheelchair passage is 36" min. and 60" min. for double wheelchair.
- Space required to turn a wheelchair is 60" dia.
- Newer wheelchair arms are designed to fit under standard 29"h tables (older models require an extra 2.5" of clearance)
- ADA Minimum table depth of 24".
- Ganging Wedges are not recommended for seating if top is not supported by a base.
- Capacities are based upon a 30" minimum width per seat. This chart is only a guideline which can vary based upon seating design and table layout.

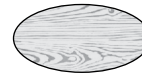

Rectangle						Racetrack				Elliptical			
18 x 30	1												
18 x 36	1	30 x 36	2										
18 x 48	1	30 x 48	2 - 4										
										30 x 54	4		
18 x 60	2	30 x 60	4	48 x 60	6	36 x 60	4			30 x 60	4		
18 x 72	3	30 x 72	6	48 x 72	6 - 8	36 x 72	4					42 x 72	6
18 x 84	4	30 x 84	6	48 x 84	6 - 8	36 x 84	6					42 x 84	6 - 8
18 x 90	4	30 x 90	6	48 x 90	8	36 x 90	8					42 x 90	8
18 x 96	4 - 5	30 x 96	8	48 x 96	8 - 10	36 x 96	6 - 8					42 x 96	8 - 10
				48 x 120	10 - 12			54 x 120	10 - 12			42 x 120	10 - 12
				48 x 144	12			54 x 144	12			42 x 144	12
20 x 36	2												
20 x 48	2	36 x 48	2 - 4										
20 x 60	2 - 3	36 x 60	4 - 6	54 x 60	6					36 x 60	4		
20 x 72	3	36 x 72	6 - 8	54 x 72	8					36 x 72	4	48 x 72	6
20 x 84	4	36 x 84	6 - 8	54 x 84	8	42 x 84	6 - 8			36 x 84	6	48 x 84	6 - 8
20 x 90	4	36 x 90	8	54 x 90	8	42 x 90	8			36 x 90	8	48 x 90	8
20 x 96	4 - 5	36 x 96	8 - 10	54 x 96	8 - 10	42 x 96	8 - 10			36 x 96	6 - 8	48 x 96	8 - 10
				54 x 120	10 - 12	42 x 120	10 - 12	60 x 120	10 - 12			48 x 120	10 - 12
				54 x 144	12	42 x 144	12	60 x 144	12			48 x 144	12
24 x 36	1												
24 x 48	1												
24 x 60	2	42 x 60	6 - 8										
24 x 72	3	42 x 72	6 - 8	60 x 72	8								
24 x 84	4	42 x 84	6 - 8	60 x 84	8	48 x 84	6 - 8						
24 x 90	4	42 x 90	8	60 x 90	8	48 x 90	8						
24 x 96	4 - 5	42 x 96	8 - 10	60 x 96	8 - 10	48 x 96	8 - 10						
				42 x 120	10 - 12	48 x 120	10 - 12						
				42 x 144	12	48 x 144	12						



Square		Round	
24 x 24	2	24 x 24	2
30 x 30	2	30 x 30	2
36 x 36	4	36 x 36	3
42 x 42	4	42 x 42	4
48 x 48	4	48 x 48	4 - 5
54 x 54	4 - 8	54 x 54	5
60 x 60	4 - 8	60 x 60	6 - 7



D-shaped

24 x 36	1	42 x 60	5 - 7
24 x 48	1	42 x 72	5 - 7
24 x 60	2	42 x 84	5 - 7
24 x 72	3	42 x 90	7
24 x 84	3	42 x 96	7 - 9
24 x 90	3	48 x 60	5 - 7
24 x 96	2 - 3	48 x 72	5 - 7
30 x 48	2 - 3	48 x 84	5 - 7
30 x 60	3	48 x 90	7
30 x 72	5	48 x 96	7 - 9
30 x 84	5	54 x 54	4
30 x 90	5	54 x 60	6
30 x 96	7	54 x 72	8
36 x 48	2 - 3	54 x 84	8
36 x 60	3 - 5	54 x 90	8
36 x 72	5 - 7	54 x 96	8 - 10
36 x 84	5 - 7	54 x 120	10 - 12
36 x 90	7	54 x 144	12
36 x 96	7 - 9	60 x 60	6
		60 x 72	8
		60 x 84	8
		60 x 90	8
		60 x 96	8 - 10
		60 x 120	10 - 12
		60 x 144	12



Boat-shaped

30 x 42 x 84	6 - 8
30 x 42 x 90	8
30 x 42 x 96	8 - 10
36 x 48 x 84	6 - 8
36 x 48 x 90	8
36 x 48 x 96	8 - 10
36 x 48 x 120	10 - 12
36 x 48 x 144	12
48 x 54 x 120	10 - 12
48 x 54 x 144	12
54 x 60 x 120	10 - 12
54 x 60 x 144	12



Squirle

24 x 24	2
30 x 30	2
36 x 36	4
42 x 42	4
48 x 48	4



Half Round

18 x 36	1 - 2
24 x 48	2
30 x 60	3
36 x 72	4



Trapezoid

24 x 48	4 - 5
24 x 72	4 - 5
30 x 60	4 - 5
36 x 72	4 - 5

tableX

QS tableXPRESS

price list

Effective January 1, 2023





Need tables quickly? TableX can ship the following models in just 7-10 business days after receipt of clean order. We now offer silver powder coated Foundation T-bases, Surge disc or Primary square column bases, and you may choose any of our standard laminates and 3mm PVC edges to create the look your client is seeking. (Maximum order = 25 tables)

Foundation T, Surge Disc & Primary square column

Base Standards

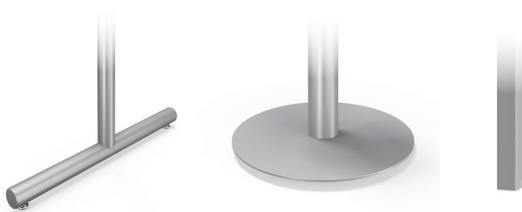

Standard Glides



Edge Options

Standard Finish Options

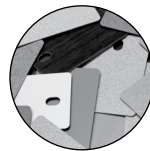
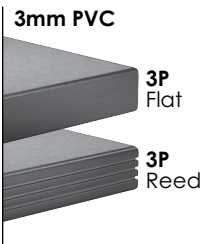

Laminates:
All standards are available. See pages 8-9 for current list.

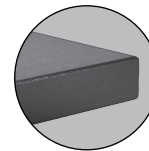

3mm Edges:
All standards are available. See page 10 for current list.

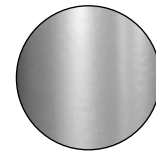

Bases:
37 Satin Silver

Top Shapes



Rectangle p.25



Racetrack p.26



Square p.25



Round p.25



Modesty Panels p.27



Rectangular with T-bases

Top Size	Base	Model Number	3P
24 x 36	Static	QS-01TC2436T20-3P	667
24 x 48	Static	QS-01TC2448T20-3P	724
24 x 60	Static	QS-01TC2460T20-3P	750
24 x 72	Static	QS-01TC2472T20-3P	801
24 x 84	Static	QS-01TC2484T20-3P	984
30 x 60	Static	QS-01TC3060T26-3P	806
30 x 72	Static	QS-01TC3072T26-3P	863
30 x 84	Static	QS-01TC3084T26-3P	1,086
36 x 60	Static	QS-01TC3660T26-3P	924
36 x 72	Static	QS-01TC3672T26-3P	978
36 x 84	Static	QS-01TC3684T26-3P	1,183

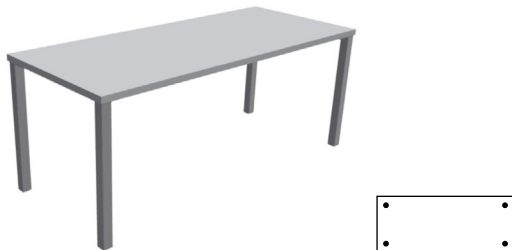

Rectangular with corner-mount square columns

Top Size	Base	Model Number	3P
24 x 36	Static	QS-44TC2436QC.2COR-3P	960
24 x 48	Static	QS-44TC2448QC.2COR-3P	1,018
24 x 60	Static	QS-44TC2460QC.2COR-3P	1,132
24 x 72	Static	QS-44TC2472QC.2COR-3P	1,182
30 x 60	Static	QS-44TC3060QC.2COR-3P	1,184
30 x 72	Static	QS-44TC3072QC.2COR-3P	1,239
36 x 60	Static	QS-44TC3660QC.2COR-3P	1,304
36 x 72	Static	QS-44TC3672QC.2COR-3P	1,356
36 x 84	Static	QS-44TC3684QC.2COR-3P	1,473



Square with thin round disc

Top Size	Base	Model Number	3P
30 x 30	Static	QS-99SQ3030D24-3P	866
30 x 30	Static	QS-99SQ3030D24-3P-SH.42	957
36 x 36	Static	QS-99SQ3636D24-3P	943
36 x 36	Static	QS-99SQ3636D24-3P-SH.42	1,035



Round with thin round disc

Top Size	Base	Model Number	3P
36 x 36	Static	QS-99RD36D24-3P	1,021
36 x 36	Static	QS-99RD36D24-3P-SH.42	1,112
42 x 42	Static	QS-99RD42D24-3P	1,142
42 x 42	Static	QS-99RD42D24-3P-SH.42	1,233

tableXpress



Square with corner mount square columns

Top Size	Base	Model Number	3P
30 x 30	Static	QS-44SQ3030QC.2COR-3P	966
36 x 36	Static	QS-44SQ3636QC.2COR-3P	1,045
42 x 42	Static	QS-44SQ4242QC.2COR-3P	1,137
48 x 48	Static	QS-44SQ4848QC.2COR-3P	1,243
60 x 60	Static	QS-44SQ6060QC.2COR-3P	1,582



Round with corner mount square columns

Top Size	Base	Model Number	3P
30 x 30	Static	QS-44RD30QC.2COR-3P	1,029
36 x 36	Static	QS-44RD36QC.2COR-3P	1,121
42 x 42	Static	QS-44RD42QC.2COR-3P	1,244
48 x 48	Static	QS-44RD48QC.2COR-3P	1,277
60 x 60	Static	QS-44RD60QC.2COR-3P	1,593



Racetrack with T-bases

Top Size	Base	Model Number	3P
36 x 72	Static	QS-01RT3672T26-3P	1,199
36 x 84	Static	QS-01RT3684T26-3P	1,533



Racetrack with disc bases

Top Size	Base	Model Number	3P
36 x 72	Static	QS-99RT3672D24-3P	2,002
36 x 72	Static	QS-99RT3672D24-3P-SH.42	2,183
36 x 84	Static	QS-99RT3684D24-3P	2,249
36 x 84	Static	QS-99RT3684D24-3P-SH.42	2,431



Adjustable height laptop table

Top Size	Base	Model Number	3P
12 x 18	Adjustable	QS-17RC1218C-AH-3P	819

Specifications:

Wilsonart D354-60 Designer White laminate
 D354 Designer White 3mm PVC edge
 or
 Wilsonart 7965K-12 Walnut Heights laminate
 Matching 3mm pvc edge



Laminate Modesty Panels

Size	Base	Model Number	3P
10 x 36	Static	QS-MP1036	138
10 x 48	Static	QS-MP1048	165
10 x 60	Static	QS-MP1060	192
10 x 72	Static	QS-MP1072	234
10 x 84	Static	QS-MP1084	260

tableXPRESS

tablex

ultra

00 ultra
price list

Effective January 1, 2023

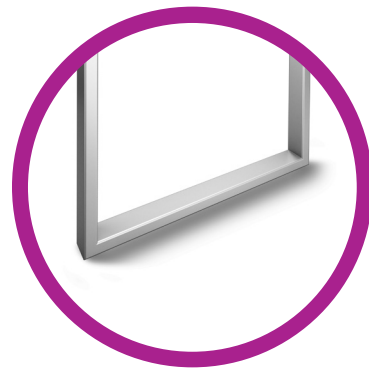



Sleek rectangular U-frame bases make a bold statement in our Ultra series. This stylish offering looks the part in a multitude of configurations, including a standing height option and locking casters.

Ultra Base Styles



U

Ultra Options

Standard Glides



Locking Casters



- LC Locking Casters**
can be added to any table for \$111 per set of four.
- FD Folding Bases**
are not available on Ultra tables.
- NE Nesting Tables**
are not available in the Ultra series.
- FT Flip Tops**
are not available on Ultra tables.
- FM Floor Mount Leveler Brackets**
are available for \$47 per table.
- OS Offset T-bases**
are not available on Ultra tables. Offset is not available on 18"d tables or 30"d nesting tables less than 60" wide.
- CH Chrome Finish**
is not available on Ultra tables.
- WM Wire Management**
Built-in wire management is not available on Ultra tables.
- MM/TC Magnetic Wire Management Leg Covers**
Magnetically attaches onto any square leg and are \$71 each.
- SH Special Height**
can be added to any table:
+ \$153 per base
Maximum height is 41".

Special height tables with tops larger than 36x72" must be custom quoted.

Ultra Top Shapes



Rectangle
p.32



Round
p.33



Boat
p.33



D-shaped
p.34

Ultra Top Options

GR Grommets
can be added to any table for \$45 each. To see specific locations, see page 227.

BB Maple Butcher Block
is 1.5" thick with food-grade clearcoat finish. Available in specific sizes with no grommets and clamp-on power only. Clamp-on power information can be found on page 219.

Call for pricing.

Edge Options

(corresponds with 3 columns of pricing)

3mm PVC

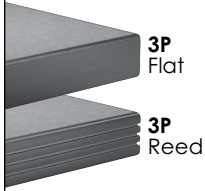

3P Flat

3P Reed

3mm PVC



N/A

3K Knife

3mm Wood



3W Flat

Butcher Block

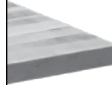

BB Maple

Call for pricing.

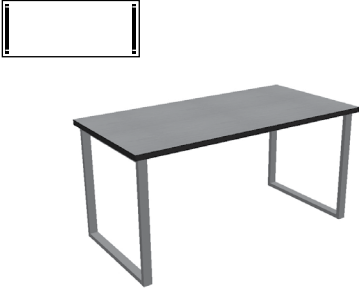

Rectangular with U-bases	Top Size	Base	Model Number	3P	3K	3W
	20 x 36	Static	00TC2036U18	\$ 877	\$ NA	\$1,133
	20 x 48	Static	00TC2048U18	935	NA	1,164
	20 x 60	Static	00TC2060U18	1,050	NA	1,284
	20 x 72	Static	00TC2072U18	1,100	NA	1,370
	20 x 84	Static	00TC2084U18	1,196	NA	1,506
	20 x 90	Static	00TC2090U18	1,253	NA	1,585
	20 x 96 *	Static	00TC2096U18	1,253	NA	1,601
	24 x 36	Static	00TC2436U22	903	NA	1,078
	24 x 48	Static	00TC2448U22	961	NA	1,172
	24 x 60	Static	00TC2460U22	1,077	NA	1,320
	24 x 72	Static	00TC2472U22	1,127	NA	1,406
	24 x 84	Static	00TC2484U22	1,223	NA	1,543
	24 x 90	Static	00TC2490U22	1,279	NA	1,622
	24 x 96 *	Static	00TC2496U22	1,279	NA	1,637
	30 x 36	Static	00TC3036U28	974	NA	1,166
	30 x 48	Static	00TC3048U28	1,044	NA	1,275
	30 x 60	Static	00TC3060U28	1,155	NA	1,420
	30 x 72	Static	00TC3072U28	1,210	NA	1,511
	30 x 84	Static	00TC3084U28	1,346	NA	1,692
	30 x 90	Static	00TC3090U28	1,418	NA	1,785
	30 x 96 *	Static	00TC3096U28	1,418	NA	1,801
	36 x 48	Static	00TC3648U34	1,127	NA	1,379
	36 x 60	Static	00TC3660U34	1,299	NA	1,592
	36 x 72	Static	00TC3672U34	1,354	NA	1,683
36 x 84	Static	00TC3684U34	1,469	NA	1,841	
36 x 90	Static	00TC3690U34	1,553	NA	1,949	
36 x 96 *	Static	00TC3696U34	1,553	NA	1,965	
42 x 60	Static	00TC4260U40	1,400	NA	1,715	
42 x 72	Static	00TC4272U40	1,502	NA	1,858	
42 x 84	Static	00TC4284U40	1,599	NA	1,995	
42 x 90	Static	00TC4290U40	1,692	NA	2,114	
42 x 96 *	Static	00TC4296U40	1,692	NA	2,130	
48 x 60	Static	00TC4860U46	1,454	NA	1,787	
48 x 72	Static	00TC4872U46	1,615	NA	1,995	
48 x 84	Static	00TC4884U46	1,625	NA	2,037	
48 x 90	Static	00TC4890U46	1,719	NA	2,157	
48 x 96 *	Static	00TC4896U46	1,719	NA	2,173	



Tables 36x72" and larger:  quote

* \$200 NET surcharge per order for oversized pallet

For Ultra table options, please reference pages 30-31.

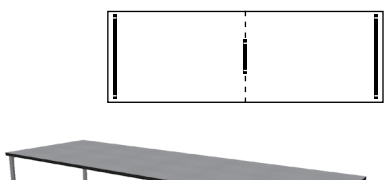
Top Size	Base	Model Number	3P	3K	3W	Rectangular with 3 U-bases
42 x 120	Static	00TC42120U40U18	\$ 2,661	\$ NA	\$ 3,201	
42 x 144	Static	00TC42144U40U18	2,855	NA	3,475	
48 x 120	Static	00TC48120U46U18	2,700	NA	3,255	
48 x 144	Static	00TC48144U46U18	2,896	NA	3,534	

LC SH ← ⊗
N/A quote 3 bases:

Top Size	Base	Model Number	3P	3K	3W	Round with 4 U-bases
48 x 48	Static	00RD48U18(4)	\$ 1,831	NA	\$ 2,076	
54 x 54	Static	00RD54U18(4)	2,029	NA	2,320	
60 x 60	Static	00RD60U18(4)	2,058	NA	2,375	

LC SH ← ⊗
N/A quote 4 bases:

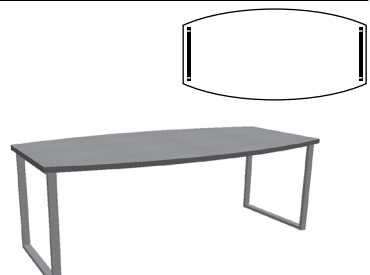
Top Size	Base	Model Number	3P	3K	3W	Boat-shaped with U-bases
30 x 42 x 84	Static	00BT3084U28	\$ 1,797	NA	\$ 2,172	
30 x 42 x 90	Static	00BT3090U28	1,932	NA	2,336	
30 x 42 x 96 *	Static	00BT3096U28	1,932	NA	2,352	
36 x 48 x 84	Static	00BT3684U34	1,957	NA	2,355	
36 x 48 x 90	Static	00BT3690U34	2,111	NA	2,540	
36 x 48 x 96 *	Static	00BT3696U34	2,111	NA	2,555	

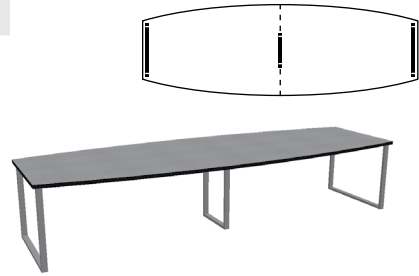
Top Size	Base	Model Number	3P	3K	3W	Boat-shaped with 3 U-bases
36 x 48 x 120	Static	00BT36120U34U18	\$ 3,194	NA	\$ 3,751	
36 x 48 x 144	Static	00BT36144U34U18	3,502	NA	4,152	

⊗ → LC SH
3 bases: N/A quote

* \$200 NET surcharge per order for oversized pallet

For Ultra table options, please reference pages 30-31.

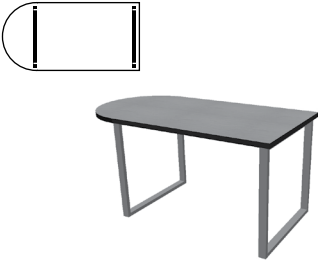
D-shaped with U-bases	Top Size	Base	Model Number	3P	3K	3W
	24 x 36	Static	00D2436U22	\$ 961	NA	\$ 1,127
	24 x 48	Static	00D2448U22	1,040	NA	1,245
	24 x 60	Static	00D2460U22	1,206	NA	1,449
	24 x 72	Static	00D2472U22	1,285	NA	1,566
	24 x 84	Static	00D2484U22	1,362	NA	1,684
	24 x 90	Static	00D2490U22	1,401	NA	1,741
	24 x 96 *	Static	00D2496U22	1,441	NA	1,800
	30 x 48	Static	00D3048U28	1,144	NA	1,370
	30 x 60	Static	00D3060U28	1,331	NA	1,596
	30 x 72	Static	00D3072U28	1,427	NA	1,734
	30 x 84	Static	00D3084U28	1,526	NA	1,873
	30 x 90	Static	00D3090U28	1,574	NA	1,943
	30 x 96 *	Static	00D3096U28	1,623	NA	2,011
	36 x 48	Static	00D3648U34	1,249	NA	1,494
	36 x 60	Static	00D3660U34	1,454	NA	1,741
	36 x 72	Static	00D3672U34	1,572	NA	1,902
	36 x 84	Static	00D3684U34	1,689	NA	2,062
	36 x 90	Static	00D3690U34	1,748	NA	2,142
36 x 96 *	Static	00D3696U34	1,805	NA	2,221	
42 x 72	Static	00D4272U40	1,945	NA	2,322	
42 x 84	Static	00D4284U40	1,978	NA	2,389	
42 x 90	Static	00D4290U40	2,055	NA	2,490	
42 x 96 *	Static	00D4296U40	2,132	NA	2,591	
48 x 72	Static	00D4872U46	2,015	NA	2,409	
48 x 84	Static	00D4884U46	2,015	NA	2,440	
48 x 90	Static	00D4890U46	2,093	NA	2,541	
48 x 96 *	Static	00D4896U46	2,172	NA	2,642	



Tables 36x72" and larger: **SH** quote

* \$200 NET surcharge per order for oversized pallet

For Ultra table options, please reference pages 30-31.



For Ultra table options, please reference pages 30-31.

tablex

01 foundation
price list
Effective January 1, 2023





foundation

Any traditional table function can be accommodated with our competitively priced and cleanly styled Foundation tables. This series is perfect for any application and stands the test of time.

Foundation Base Styles

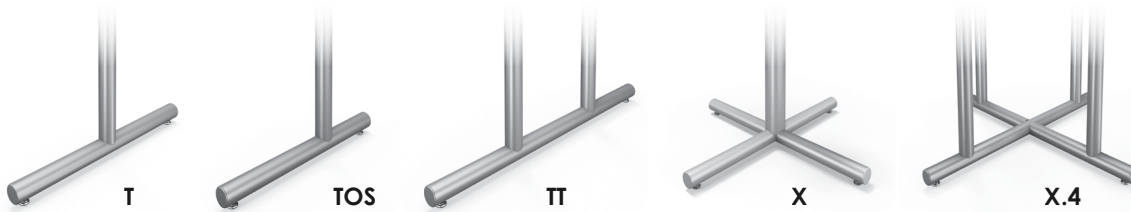

Foundation Options

- LC** **Locking Casters** can be added to any table for \$111 per set of four.
- CGG** **Concealed Casters** available on one T-base for \$137 per table. Standard glides on opposite base.
- BN** **Bullnose End** available on all Foundation bases for \$73 per table.
- FD** **Folding Bases** priced accordingly with standard glides.
- NE** **Nesting Tables** priced accordingly with locking casters.
- FM** **Floor Mount Leveler Brackets** are available for \$47 per table.
- FT** **Flip Tops** available on X-based tables and are priced with standard glides.
- OS** **Offset T-bases** available for \$39 per table. Offset is not available on 18"d tables or 30"d nesting tables less than 60" wide.
- CH** **Chrome Finish** available for \$130 on most models. Upcharge for disc bases is \$499.
- WM** **Wire Management** Built-in wire management is available for \$139 per column. Specify inside or outside of column.
- WM LC** **Wire Management Leg Covers 2"** snap onto any leg and are \$50 each.
- SH** **Special Height** can be added to any table:
 - + \$72 per column for heights > 29"
 - + \$39 per column for heights < 29"
 Special height tables with tops larger than 36x72" must be custom quoted.
- FR** **Footring** available on standing height disc-bases for \$166 per base. Not available in chrome.
- PB** **Powerbox Mounting Plate** is available on disc & X-bases for \$100.

Foundation Height Adjustable Options

- NU Pneumatic** is available on X-bases for \$387 and on T-bases for \$772 per table. For height option details, see page 19.
- AH Spring Clip** is available on X-bases for \$139 and on T-bases for \$277 per table. For height option details, see page 19.
- RA Ratchet** is available on T-bases and nesting for \$507 per table. Available height adjustable finishes can be found on page 9.
- EX Manual Extended Height** is available on T-bases for \$205 per table. For height option details, see page 19.

Foundation Top Shapes

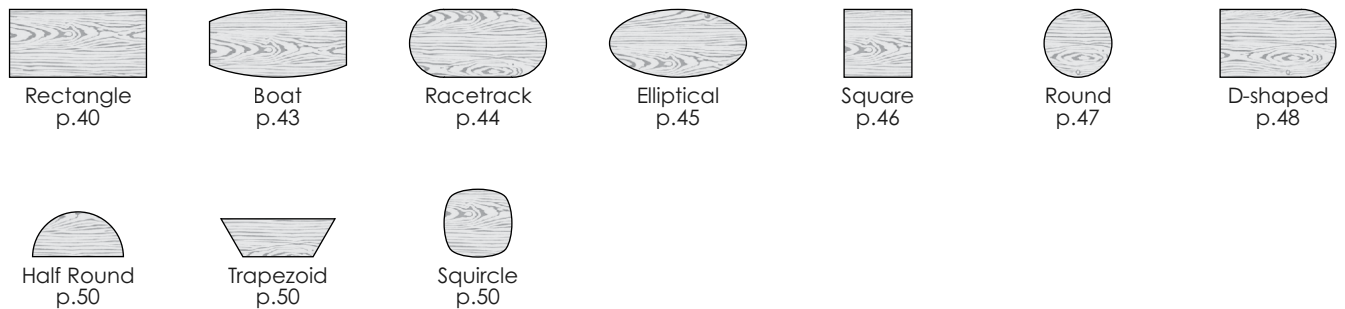

foundation





Foundation Top Options

- QG Quick-Connect Ganging Brackets** can be added to any table for \$45 (includes 4 connectors per table).
- RC 3" Radius Corners** can be added to any table for \$61.
- GR Grommets** can be added to any table for \$45 each. To see specific locations, see page 227.

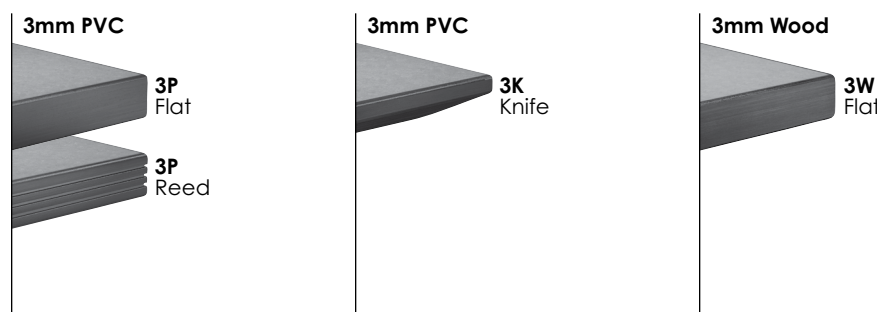
Foundation Edge Options

(corresponds with 3 columns of pricing)



Rectangular with T-bases	Top Size	Base	Model Number	3P	3K	3W
   	18 x 36	Static	01TC1836T16	\$ 621	\$ 675	\$ 774
		Nesting	01TC1836T18NE	1,315	1,368	1,465
	18 x 48	Static	01TC1848T16	665	735	853
		Folding	01TC1848T16FD	992	1,064	1,182
		Nesting	01TC1848T18NE	1,358	1,427	1,543
	18 x 60	Static	01TC1860T16	708	797	933
		Folding	01TC1860T16FD	1,049	1,139	1,274
		Nesting	01TC1860T18NE	1,401	1,488	1,621
	18 x 72	Static	01TC1872T16	752	857	1,011
		Folding	01TC1872T16FD	1,094	1,200	1,353
		Nesting	01TC1872T18NE	1,678	1,782	1,934
	18 x 84	Static	01TC1884T16	885	1,007	1,180
		Folding	01TC1884T16FD	1,137	1,262	1,432
		Nesting	01TC1884T18NE	1,720	1,843	2,011
	18 x 90	Static	01TC1890T16	927	1,068	1,243
		Folding	01TC1890T16FD	1,181	1,321	1,496
		Nesting	01TC1890T18NE	1,763	1,903	2,073
	18 x 96 *	Static	01TC1896T16	927	1,068	1,257
Folding		01TC1896T16FD	1,181	1,321	1,511	
Nesting		01TC1896T18NE	1,763	1,903	2,088	
20 x 36	Static	01TC2036T18	662	734	826	
	Nesting	01TC2036T20NE	1,360	1,430	1,520	
20 x 48	Static	01TC2048T18	720	814	920	
	Folding	01TC2048T18FD	1,048	1,142	1,248	
	Nesting	01TC2048T20NE	1,417	1,508	1,612	
20 x 60	Static	01TC2060T18	747	851	980	
	Folding	01TC2060T18FD	1,088	1,193	1,321	
	Nesting	01TC2060T20NE	1,442	1,544	1,671	
20 x 72	Static	01TC2072T18	797	920	1,066	
	Folding	01TC2072T18FD	1,138	1,263	1,407	
	Nesting	01TC2072T20NE	1,727	1,847	1,990	
20 x 84	Static	01TC2084T18	981	1,144	1,291	
	Folding	01TC2084T18FD	1,234	1,397	1,544	
	Nesting	01TC2084T20NE	1,820	1,980	2,125	
20 x 90	Static	01TC2090T18	1,039	1,224	1,371	
	Folding	01TC2090T18FD	1,292	1,477	1,623	
	Nesting	01TC2090T20NE	1,877	2,058	2,201	
20 x 96 *	Static	01TC2096T18	1,039	1,224	1,385	
	Folding	01TC2096T18FD	1,292	1,477	1,638	
	Nesting	01TC2096T20NE	1,877	2,058	2,217	

* \$200 NET surcharge per order for oversized pallet

For Foundation series table options, please reference pages 38-39.



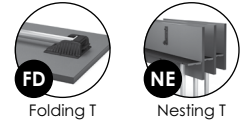

Top Size	Base	Model Number	3P	3K	3W	Rectangular with T-bases
24 x 36	Static	01TC2436T20	\$ 667	\$ 738	\$ 840	
	Nesting	01TC2436T22NE	1,360	1,430	1,530	
24 x 48	Static	01TC2448T20	724	818	934	
	Folding	01TC2448T20FD	1,052	1,146	1,263	
	Nesting	01TC2448T22NE	1,417	1,508	1,623	
24 x 60	Static	01TC2460T20	750	855	995	
	Folding	01TC2460T20FD	1,092	1,196	1,336	
	Nesting	01TC2460T22NE	1,442	1,544	1,682	
24 x 72	Static	01TC2472T20	801	924	1,080	
	Folding	01TC2472T20FD	1,142	1,266	1,421	
	Nesting	01TC2472T22NE	1,727	1,847	2,001	
24 x 84	Static	01TC2484T20	984	1,147	1,306	
	Folding	01TC2484T20FD	1,238	1,400	1,559	
	Nesting	01TC2484T22NE	1,820	1,980	2,134	
24 x 90	Static	01TC2490T20	1,042	1,228	1,383	
	Folding	01TC2490T20FD	1,295	1,481	1,637	
	Nesting	01TC2490T22NE	1,877	2,058	2,212	
24 x 96 *	Static	01TC2496T20	1,042	1,228	1,399	
	Folding	01TC2496T20FD	1,295	1,481	1,652	
	Nesting	01TC2496T22NE	1,877	2,058	2,226	
30 x 36	Static	01TC3036T26	713	801	907	
	Nesting	01TC3036T26NE	1,405	1,491	1,595	
30 x 48	Static	01TC3048T26	784	900	1,015	
	Folding	01TC3048T26FD	1,112	1,228	1,342	
	Nesting	01TC3048T26NE	1,475	1,590	1,703	
30 x 60	Static	01TC3060T26	806	932	1,070	
	Folding	01TC3060T26FD	1,147	1,273	1,412	
	Nesting	01TC3060T26NE	1,497	1,620	1,756	
30 x 72	Static	01TC3072T26	863	1,008	1,163	
	Folding	01TC3072T26FD	1,203	1,351	1,505	
	Nesting	01TC3072T26NE	1,785	1,930	2,082	
30 x 84	Static	01TC3084T26	1,086	1,287	1,431	
	Folding	01TC3084T26FD	1,338	1,540	1,685	
	Nesting	01TC3084T26NE	1,919	2,116	2,258	
30 x 90	Static	01TC3090T26	1,157	1,386	1,525	
	Folding	01TC3090T26FD	1,410	1,641	1,778	
30 x 96 *	Static	01TC3096T26	1,157	1,386	1,541	
	Folding	01TC3096T26FD	1,410	1,641	1,794	





foundation

* \$200 NET surcharge per order for oversized pallet



For Foundation series table options, please reference pages 38-39.

Rectangular with T-bases	Top Size	Base	Model Number	3P	3K	3W
   	36 x 48	Static	01TC3648T26	\$ 840	\$ 979	\$ 1,092
		Folding	01TC3648T26FD	1,168	1,308	1,421
		Nesting	01TC3648T26NE	1,663	1,799	1,910
	36 x 60	Static	01TC3660T26	924	1,098	1,217
		Folding	01TC3660T26FD	1,267	1,439	1,559
		Nesting	01TC3660T26NE	1,821	1,991	2,108
	36 x 72	Static	01TC3672T26	978	1,173	1,307
		Folding	01TC3672T26FD	1,319	1,514	1,648
		Nesting	01TC3672T26NE	1,901	2,091	2,222
	36 x 84	Static	01TC3684T26	1,183	1,423	1,554
		Folding	01TC3684T26FD	1,437	1,676	1,806
	36 x 90	Static	01TC3690T26	1,267	1,541	1,662
		Folding	01TC3690T26FD	1,520	1,794	1,915
	36 x 96 *	Static	01TC3696T26	1,267	1,541	1,676
		Folding	01TC3696T26FD	1,520	1,794	1,930



Rectangular with TT-bases	Top Size	Base	Model Number	3P	3K	3W
  	42 x 60	Static	01TC4260TT34	\$ 1,223	\$ 1,424	\$ 1,538
		Nesting	01TC4260TT34NE	2,306	2,505	2,615
	42 x 72	Static	01TC4272TT34	1,323	1,566	1,680
		Nesting	01TC4272TT34NE	2,406	2,642	2,754
	42 x 84	Static	01TC4284TT34	1,509	1,791	1,906
	42 x 90	Static	01TC4290TT34	1,603	1,922	2,024
	42 x 96 *	Static	01TC4296TT34	1,603	1,922	2,041
	48 x 60	Static	01TC4860TT36	1,250	1,463	1,583
		Nesting	01TC4860TT36NE	2,333	2,543	2,659
	48 x 72	Static	01TC4872TT36	1,410	1,688	1,791
		Nesting	01TC4872TT36NE	2,490	2,763	2,863
	48 x 84	Static	01TC4884TT36	1,509	1,791	1,922
	48 x 90	Static	01TC4890TT36	1,604	1,924	2,042
	48 x 96 *	Static	01TC4896TT36	1,604	1,924	2,057

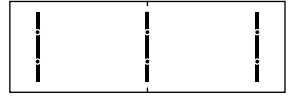

* \$200 NET surcharge per order for oversized pallet

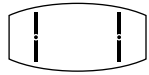

For Foundation series table options, please reference pages 38-39.

Top Size	Base	Model Number	3P	3K	3W	Rectangular with 3 TT-bases
42 x 120	Static	01TC42120TT34(3)	\$ 2,315	\$ 2,789	\$ 2,853	 
42 x 144	Static	01TC42144TT34(3)	2,509	3,060	3,128	
48 x 120	Static	01TC48120TT36(3)	2,327	2,806	2,882	
48 x 144	Static	01TC48144TT36(3)	2,524	3,080	3,160	

LC CH SH ⊗
 N/A +171 quote 3 bases:

Top Size	Base	Model Number	3P	3K	3W	Boat-shaped with T-bases
30 x 42 x 84	Static	01BT3084T26	\$ 1,536	\$ 1,918	\$ 1,911	 
30 x 42 x 90	Static	01BT3090T26	1,671	2,108	2,076	
30 x 42 x 96 *	Static	01BT3096T26	1,671	2,108	2,091	

Top Size	Base	Model Number	3P	3K	3W	Boat-shaped with TT-bases
36 x 48 x 84	Static	01BT3684TT34	\$ 1,894	\$ 2,329	\$ 2,292	 
36 x 48 x 90	Static	01BT3690TT34	2,048	2,546	2,477	
36 x 48 x 96 *	Static	01BT3696TT34	2,048	2,546	2,492	



Top Size	Base	Model Number	3P	3K	3W	Boat-shaped with 3 TT-bases
36 x 48 x 120	Static	01BT36120TT36(3)	\$ 2,874	\$ 3,570	\$ 3,430	 
36 x 48 x 144	Static	01BT36144TT36(3)	3,182	4,003	3,831	

LC CH SH ⊗
 N/A +171 quote 3 bases:



* \$200 NET surcharge per order for oversized pallet

For Foundation series table options, please reference pages 38-39.

foundation

Racetrack with T-bases	Top Size	Base	Model Number	3P	3K	3W
   	36 x 60	Static	01RT3660T26	\$ 1,199	\$ 1,480	\$ 1,477
		Nesting	01RT3660T26NE	2,014	2,289	2,287
	36 x 72	Static	01RT3672T26	1,199	1,480	1,508
		Folding	01RT3672T26FD	1,539	1,821	1,850
		Nesting	01RT3672T26NE	2,089	2,366	2,393
	36 x 84	Static	01RT3684T26	1,533	1,914	1,900
		Folding	01RT3684T26FD	1,785	2,168	2,152
	36 x 90	Static	01RT3690T26	1,671	2,108	2,067
		Folding	01RT3690T26FD	1,925	2,362	2,321
	36 x 96 *	Static	01RT3696T26	1,671	2,108	2,083
		Folding	01RT3696T26FD	1,925	2,362	2,336

Racetrack with TT-bases	Top Size	Base	Model Number	3P	3K	3W
 	42 x 84	Static	01RT4284TT34	\$ 1,757	\$ 2,137	\$ 2,132
	42 x 90	Static	01RT4290TT34	1,895	2,331	2,300
	42 x 96 *	Static	01RT4296TT34	1,895	2,331	2,315
	48 x 84	Static	01RT4884TT34	2,048	2,546	2,462
	48 x 90	Static	01RT4890TT34	2,048	2,546	2,477
	48 x 96 *	Static	01RT4896TT34	2,048	2,546	2,492

Racetrack with 3 TT-bases	Top Size	Base	Model Number	3P	3K	3W
 	42 x 120	Static	01RT42120TT34(3)	\$ 2,858	\$ 3,547	\$ 3,404
	42 x 144	Static	01RT42144TT34(3)	3,162	3,975	3,800
	48 x 120	Static	01RT48120TT36(3)	2,874	3,572	3,431
	48 x 144	Static	01RT48144TT36(3)	3,183	4,004	3,832

 →
 LC CH SH
 3 bases: N/A +171 quote

* \$200 NET surcharge per order for oversized pallet

For Foundation series table options, please reference pages 38-39.

Top Size	Base	Model Number	3P	3K	3W	Elliptical with T-bases
30 x 54	Static	01EL3054T22	\$ 935	\$ 1,112	\$ 1,150	
30 x 60	Static	01EL3060T22	981	1,179	1,213	
36 x 60	Static	01EL3660T26	1,085	1,321	1,339	
36 x 72	Static	01EL3672T26	1,199	1,480	1,488	
36 x 84	Static	01EL3684T26	1,404	1,734	1,731	
36 x 90	Static	01EL3690T26	1,518	1,893	1,867	
36 x 96 *	Static	01EL3696T26	1,518	1,893	1,880	

Top Size	Base	Model Number	3P	3K	3W	Elliptical with TT-bases
42 x 72	Static	01EL4272TT26	\$ 1,464	\$ 1,794	\$ 1,779	
42 x 84	Static	01EL4284TT26	1,682	2,062	2,033	
42 x 90	Static	01EL4290TT26	1,822	2,259	2,200	
42 x 96 *	Static	01EL4296TT26	1,822	2,259	2,213	
48 x 72	Static	01EL4872TT30	1,617	1,992	1,956	
48 x 84	Static	01EL4884TT30	2,013	2,510	2,406	
48 x 90	Static	01EL4890TT30	2,013	2,510	2,418	
48 x 96 *	Static	01EL4896TT30	2,013	2,510	2,431	



Top Size	Base	Model Number	3P	3K	3W	Elliptical with 3 TT-bases
42 x 120	Static	01EL42120TT34(3)	\$ 2,858	\$ 3,547	\$ 3,359	
42 x 144	Static	01EL42144TT34(3)	3,162	3,975	3,744	
48 x 120	Static	01EL48120TT36(3)	2,874	3,572	3,391	
48 x 144	Static	01EL48144TT36(3)	3,183	4,004	3,779	



LC CH SH ← ⊗
 N/A +171 quote 3 bases:



* \$200 NET surcharge per order for oversized pallet

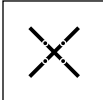

For Foundation series table options, please reference pages 38-39.

foundation

Square with X-base		Top Size	Base	Model Number	3P	3K	3W
   <p>Flip Top X</p>	24 x 24	Static	01SQ2424X22	\$ 535	\$ 582	\$ 670	
		Flip Top	01SQ2424X22FT	698	745	833	
	30 x 30	Static	01SQ3030X26	606	680	781	
		Flip Top	01SQ3030X26FT	769	844	943	
	36 x 36	Static	01SQ3636X32	708	812	920	
		Flip Top	01SQ3636X32FT	871	976	1,084	
	42 x 42	Static	01SQ4242X36	816	958	1,069	
		Flip Top	01SQ4242X36FT	1,059	1,201	1,313	
	48 x 48	Static	01SQ4848X38	947	1,131	1,243	

Square with 4-column X-base		Top Size	Base	Model Number	3P	3K	3W
 	54 x 54	Static	01SQ5454X36.4	\$ 1,323	\$ 1,556	\$ 1,662	
	60 x 60	Static	01SQ6060X42.4	1,499	1,783	1,882	

 →
  
 X.4: N/A +286

Square with TT-bases		Top Size	Base	Model Number	3P	3K	3W
   <p>Nesting TT</p>	48 x 48	Static	01SQ4848TT34	\$ 1,175	\$ 1,359	\$ 1,470	
		Nesting	01SQ4848TT34NE	2,260	2,440	2,549	



For Foundation series table options, please reference pages 38-39.

Top Size	Base	Model Number	3P	3K	3W	Round with X-base
24 x 24	Static	01RD24X22	\$ 574	\$ 638	\$ 688	
	Flip Top	01RD24X22FT	738	802	851	
30 x 30	Static	01RD30X26	669	768	815	
	Flip Top	01RD30X26FT	832	932	979	
36 x 36	Static	01RD36X30	783	918	962	
	Flip Top	01RD36X30FT	945	1,081	1,125	
42 x 42	Static	01RD42X32	907	1,091	1,123	
	Flip Top	01RD42X32FT	1,149	1,334	1,365	
48 x 48	Static	01RD48X36	958	1,157	1,203	

Top Size	Base	Model Number	3P	3K	3W	Round with 4-column X-base
54 x 54	Static	01RD54X32.4	\$ 1,376	\$ 1,653	\$ 1,665	
60 x 60	Static	01RD60X36.4	1,467	1,756	1,783	





Top Size	Base	Model Number	3P	3K	3W	Round with TT-bases
48 x 48	Static	01RD48TT26	\$ 1,137	\$ 1,335	\$ 1,381	
	Nesting	01RD48TT26NE	2,221	2,415	2,462	
54 x 54	Static	01RD54TT30	1,376	1,653	1,665	
	Nesting	01RD54TT30NE	2,456	2,728	2,740	
60 x 60	Static	01RD60TT34	1,440	1,729	1,756	
	Folding	01RD60TT34FD	2,195	2,484	2,511	
	Nesting	01RD60TT34NE	2,519	2,803	2,829	

For Foundation series table options, please reference pages 38-39.

D-shaped with T-bases	Top Size	Base	Model Number	3P	3K	3W
 	24 x 36	Static	01D2436T20	\$ 723	\$ 816	\$ 890
		Nesting	01D2436T20NE	1,417	1,508	1,579
	24 x 48	Static	01D2448T20	802	927	1,006
		Nesting	01D2448T20NE	1,493	1,615	1,693
	24 x 60	Static	01D2460T20	879	1,036	1,123
		Nesting	01D2460T20NE	1,570	1,724	1,808
	24 x 72	Static	01D2472T20	958	1,145	1,241
		Nesting	01D2472T20NE	1,688	1,872	1,966
 Nesting T	24 x 84	Static	01D2484T20	1,124	1,342	1,445
		Nesting	01D2484T20NE	1,958	2,172	2,272
	24 x 90	Static	01D2490T20	1,163	1,398	1,504
		Nesting	01D2490T20NE	1,995	2,225	2,329
	24 x 96 *	Static	01D2496T20	1,203	1,453	1,563
		Nesting	01D2496T20NE	2,034	2,280	2,387
	30 x 48	Static	01D3048T26	882	1,040	1,108
		Nesting	01D3048T26NE	1,573	1,727	1,794
	30 x 60	Static	01D3060T26	981	1,176	1,247
		Nesting	01D3060T26NE	1,669	1,861	1,929
	30 x 72	Static	01D3072T26	1,079	1,313	1,384
		Nesting	01D3072T26NE	1,806	2,037	2,107
	30 x 84	Static	01D3084T26	1,266	1,539	1,612
		Nesting	01D3084T26NE	2,095	2,364	2,435
	30 x 90	Static	01D3090T26	1,314	1,607	1,682
	30 x 96 *	Static	01D3096T26	1,362	1,674	1,751
	36 x 48	Static	01D3648T26	961	1,149	1,206
		Nesting	01D3648T26NE	1,649	1,834	1,889
	36 x 60	Static	01D3660T26	1,079	1,313	1,365
		Nesting	01D3660T26NE	1,855	2,085	2,136
	36 x 72	Static	01D3672T26	1,196	1,477	1,526
		Nesting	01D3672T26NE	2,087	2,364	2,411
	36 x 84	Static	01D3684T26	1,401	1,730	1,775
	36 x 90	Static	01D3690T26	1,461	1,813	1,855
36 x 96 *	Static	01D3696T26	1,519	1,894	1,935	

* \$200 NET surcharge per order for oversized pallet

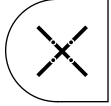
For Foundation series table options, please reference pages 38-39.

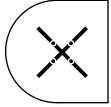

Top Size	Base	Model Number	3P	3K	3W	D-shaped with TT-bases	
42 x 60	Static	01D4260TT34	\$ 1,768	\$ 2,188	\$ 2,113	 	
	Nesting	01D4260TT34NE	2,840	3,252	3,180		
42 x 72	Static	01D4272TT34	1,768	2,188	2,145		
	Nesting	01D4272TT34NE	2,840	3,252	3,210		
42 x 84	Static	01D4284TT34	1,888	2,322	2,300		
42 x 90	Static	01D4290TT34	1,966	2,430	2,400		
42 x 96 *	Static	01D4296TT34	2,043	2,538	2,502		
48 x 60	Static	01D4860TT36	1,812	2,247	2,173		  
	Nesting	01D4860TT36NE	2,883	3,312	3,239		
48 x 72	Static	01D4872TT36	1,812	2,247	2,204		
	Nesting	01D4872TT36NE	2,883	3,312	3,269		
48 x 84	Static	01D4884TT36	1,900	2,337	2,324		
48 x 90	Static	01D4890TT36	1,978	2,446	2,425		
48 x 96 *	Static	01D4896TT36	2,055	2,555	2,527		



Top Size	Base	Model Number	3P	3K	3W	D-shaped with 4-column X-base
54 x 54	Static	01D5454X36.4	\$ 1,712	\$ 2,099	\$ 2,073	 
60 x 60	Static	01D6060X42.4	1,764	2,155	2,139	

CH	SH	←	⊗
N/A	+286	X.4:	

* \$200 NET surcharge per order for oversized pallet

For Foundation series table options, please reference pages 38-39.

Half Round with T-bases	Top Size	Base	Model Number	3P	3K	3W
  Nesting T	18 x 36	Static	01HR1836T16	\$ 731	\$ 829	\$ 875
	24 x 48	Static	01HR2448T16	802	929	993
		Nesting	01HR2448T16NE	1,493	1,617	1,680
	30 x 60	Static	01HR3060T20	979	1,175	1,228
		Nesting	01HR3060T22NE	1,667	1,859	1,910
	36 x 72	Static	01HR3672T26	1,195	1,475	1,505
		Nesting	01HR3672T26NE	2,011	2,285	2,314

Trapezoid with T-bases	Top Size	Base	Model Number	3P	3K	3W
  Nesting T	24 x 48	Static	01TZ2448T18	\$ 791	\$ 914	\$ 982
	24 x 72	Static	01TZ2472T18	990	1,191	1,279
		Nesting	01TZ2472T18NE	1,676	1,875	1,962
	30 x 60	Static	01TZ3060T22	927	1,102	1,171
		Nesting	01TZ3060T22NE	1,616	1,789	1,856
	36 x 72	Static	01TZ3672T26	1,166	1,437	1,474
		Nesting	01TZ3672T26NE	1,983	2,247	2,284

Squircle with X-base	Top Size	Base	Model Number	3P	3K	3W
	24 x 24	Static	01SL24X22	\$ 755	\$ 892	\$ 914
		Flip Top	01SL24X22FT	918	1,055	1,077
	30 x 30	Static	01SL30X26	823	982	1,018
		Flip Top	01SL30X26FT	985	1,145	1,181
	36 x 36	Static	01SL36X32	911	1,097	1,144
		Flip Top	01SL36X32FT	1,074	1,260	1,308
	42 x 42	Static	01SL42X36	1,000	1,215	1,271
		Flip Top	01SL42X36FT	1,243	1,458	1,515
	48 x 48	Static	01SL48X38	1,111	1,360	1,422

For Foundation series table options, please reference pages 38-39.

For Foundation series table options, please reference pages 38-39.

tablex

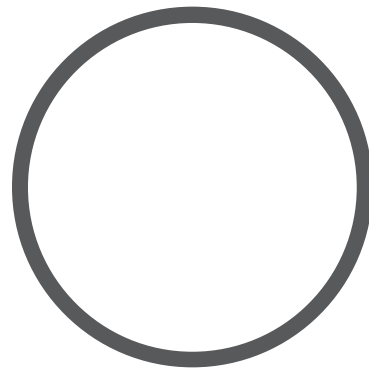

02 fundamental
price list
Effective January 1, 2023

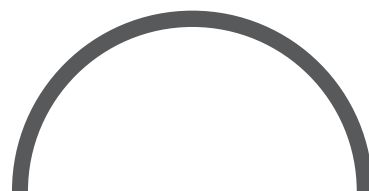





Large installations often dictate the need for a durable, versatile, and budget conscious table option. Fundamental meets these needs in addition to making installations easy.

Fundamental Base Styles

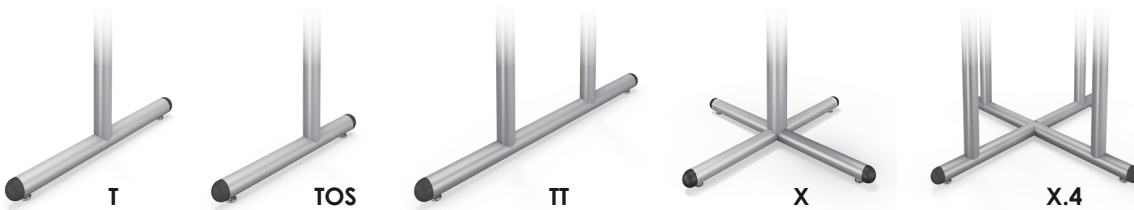
fundamental

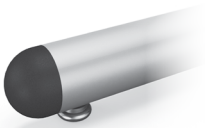

Fundamental Options

<p>Standard Glides</p> 	<p>LC Locking Casters can be added to any table for \$111 per set of four.</p>	<p>OS Offset T-bases available for \$39 per table. Offset is not available on 18" d tables or 30" d nesting tables less than 60" wide.</p>	<p>FM Floor Mount Leveler Brackets are available for \$47 per table.</p>
<p>Locking Casters</p> 	<p>CCG Concealed Casters available on one T-base for \$137 per table. Standard glides on opposite base.</p>	<p>CH Chrome Finish available for \$130 on most models. Upcharge for disc bases is \$499.</p>	<p>SH Special Height can be added to any table: + \$72 per column for heights > 29" + \$39 per column for heights < 29" Special height tables with tops larger than 36x72" must be custom quoted.</p>
<p>Concealed Casters</p> 	<p>FD Folding Bases priced accordingly with standard glides.</p> <p>NE Nesting Tables priced accordingly with locking casters.</p> <p>FT Flip Tops available on X-based tables and are priced with standard glides.</p>	<p>WM Wire Management Built-in wire management is available for \$139 per column. Specify inside or outside of column.</p> <p>WM/LC Wire Management Leg Covers 2" snap onto any leg and are \$50 each.</p>	<p>FR Footring available on standing height disc-bases for \$166 per base. Not available in chrome.</p> <p>PB Powerbox Mounting Plate is available on disc & X-bases for \$100.</p>

Fundamental Height Adjustable Options

- NU Pneumatic** is available on X-bases for \$387 and on T-bases for \$772 per table. For height option details, see page 19.
- AH Spring Clip** is available on X-bases for \$139 and on T-bases for \$277 per table. For height option details, see page 19.
- RA Ratchet** is available on T-bases and nesting for \$507 per table. Available height adjustable finishes can be found on page 9.
- EX Manual Extended Height** is available on T-bases for \$205 per table. For height option details, see page 19.

Fundamental Top Shapes

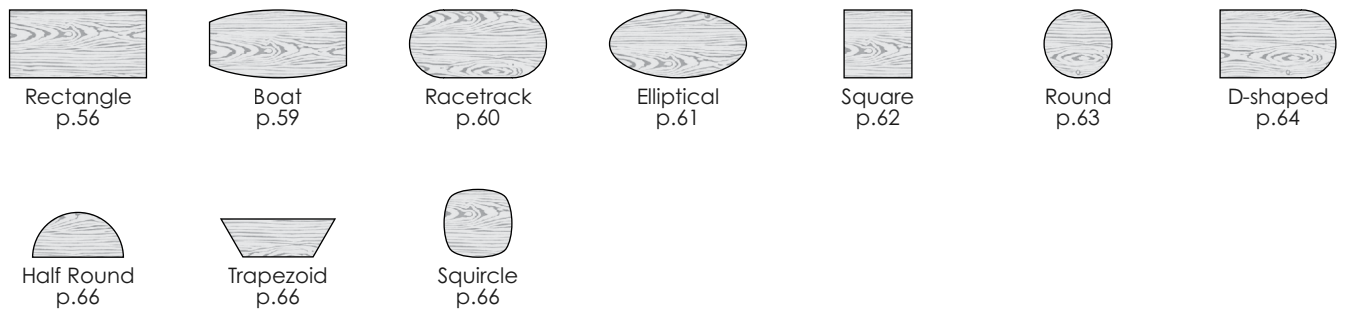

fundamental





Fundamental Top Options

- QG Quick-Connect Ganging Brackets** can be added to any table for \$45 (includes 4 connectors per table).
- RC 3" Radius Corners** can be added to any table for \$61.
- GR Grommets** can be added to any table for \$45 each. To see specific locations, see page 227.

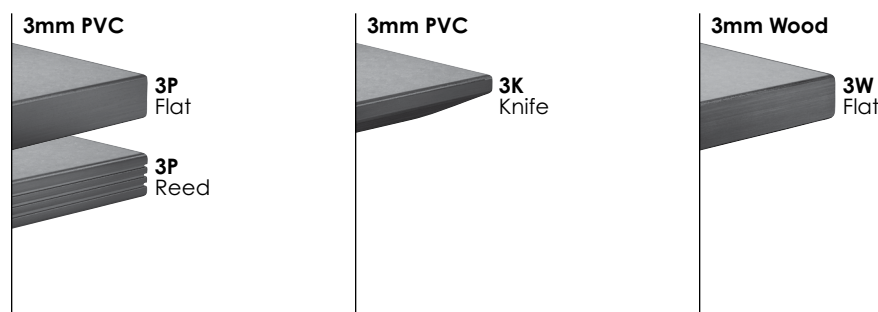
Fundamental Edge Options





(corresponds with 3 columns of pricing)



Rectangular with T-bases	Top Size	Base	Model Number	3P	3K	3W
    <p>Folding T Nesting T</p>	18 x 36	Static	O2TC1836T16	\$ 611	\$ 665	\$ 764
		Nesting	O2TC1836T18NE	1,306	1,358	1,456
	18 x 48	Static	O2TC1848T16	655	726	844
		Folding	O2TC1848T16FD	983	1,055	1,172
		Nesting	O2TC1848T18NE	1,349	1,419	1,533
	18 x 60	Static	O2TC1860T16	699	787	922
		Folding	O2TC1860T16FD	1,041	1,129	1,265
		Nesting	O2TC1860T18NE	1,392	1,478	1,612
	18 x 72	Static	O2TC1872T16	742	849	1,002
		Folding	O2TC1872T16FD	1,084	1,190	1,343
		Nesting	O2TC1872T18NE	1,669	1,774	1,924
	18 x 84	Static	O2TC1884T16	874	999	1,169
		Folding	O2TC1884T16FD	1,128	1,251	1,423
		Nesting	O2TC1884T18NE	1,712	1,834	2,002
	18 x 90	Static	O2TC1890T16	918	1,059	1,233
		Folding	O2TC1890T16FD	1,171	1,313	1,486
		Nesting	O2TC1890T18NE	1,755	1,894	2,064
	18 x 96 *	Static	O2TC1896T16	918	1,059	1,249
	Folding	O2TC1896T16FD	1,171	1,313	1,502	
	Nesting	O2TC1896T18NE	1,755	1,894	2,079	
20 x 36	Static	O2TC2036T18	654	724	816	
	Nesting	O2TC2036T20NE	1,352	1,421	1,511	
20 x 48	Static	O2TC2048T18	711	805	911	
	Folding	O2TC2048T18FD	1,040	1,133	1,239	
	Nesting	O2TC2048T20NE	1,407	1,499	1,603	
20 x 60	Static	O2TC2060T18	738	843	971	
	Folding	O2TC2060T18FD	1,079	1,184	1,313	
	Nesting	O2TC2060T20NE	1,433	1,536	1,663	
20 x 72	Static	O2TC2072T18	787	912	1,056	
	Folding	O2TC2072T18FD	1,129	1,253	1,398	
	Nesting	O2TC2072T20NE	1,717	1,839	1,981	
20 x 84	Static	O2TC2084T18	971	1,134	1,283	
	Folding	O2TC2084T18FD	1,225	1,388	1,535	
	Nesting	O2TC2084T20NE	1,812	1,971	2,115	
20 x 90	Static	O2TC2090T18	1,028	1,215	1,360	
	Folding	O2TC2090T18FD	1,283	1,468	1,614	
	Nesting	O2TC2090T20NE	1,867	2,049	2,193	
20 x 96 *	Static	O2TC2096T18	1,028	1,215	1,376	
	Folding	O2TC2096T18FD	1,283	1,468	1,629	
	Nesting	O2TC2096T20NE	1,867	2,049	2,209	

* \$200 NET surcharge per order for oversized pallet





For Fundamental series table options, please reference pages 54-55.



Top Size	Base	Model Number	3P	3K	3W	Rectangular with T-bases
24 x 36	Static	02TC2436T20	\$ 657	\$ 728	\$ 831	   
	Nesting	02TC2436T22NE	1,352	1,421	1,521	
24 x 48	Static	02TC2448T20	716	809	924	
	Folding	02TC2448T20FD	1,043	1,137	1,253	
	Nesting	02TC2448T22NE	1,407	1,499	1,614	
24 x 60	Static	02TC2460T20	742	846	985	
	Folding	02TC2460T20FD	1,084	1,187	1,328	
	Nesting	02TC2460T22NE	1,433	1,536	1,672	
24 x 72	Static	02TC2472T20	791	915	1,070	
	Folding	02TC2472T20FD	1,132	1,256	1,412	
	Nesting	02TC2472T22NE	1,717	1,839	1,992	
24 x 84	Static	02TC2484T20	976	1,139	1,296	
	Folding	02TC2484T20FD	1,229	1,392	1,549	
	Nesting	02TC2484T22NE	1,812	1,971	2,126	
24 x 90	Static	02TC2490T20	1,033	1,218	1,375	
	Folding	02TC2490T20FD	1,287	1,472	1,628	
	Nesting	02TC2490T22NE	1,867	2,049	2,202	
24 x 96 *	Static	02TC2496T20	1,033	1,218	1,390	
	Folding	02TC2496T20FD	1,287	1,472	1,644	
	Nesting	02TC2496T22NE	1,867	2,049	2,218	
30 x 36	Static	02TC3036T26	703	791	896	
	Nesting	02TC3036T26NE	1,397	1,483	1,586	
30 x 48	Static	02TC3048T26	775	891	1,006	
	Folding	02TC3048T26FD	1,103	1,220	1,334	
	Nesting	02TC3048T26NE	1,466	1,581	1,693	
30 x 60	Static	02TC3060T26	797	922	1,062	
	Folding	02TC3060T26FD	1,139	1,264	1,403	
	Nesting	02TC3060T26NE	1,488	1,610	1,748	
30 x 72	Static	02TC3072T26	852	1,000	1,154	
	Folding	02TC3072T26FD	1,194	1,341	1,495	
	Nesting	02TC3072T26NE	1,777	1,922	2,072	
30 x 84	Static	02TC3084T26	1,076	1,277	1,422	
	Folding	02TC3084T26FD	1,330	1,531	1,675	
	Nesting	02TC3084T26NE	1,910	2,108	2,249	
30 x 90	Static	02TC3090T26	1,147	1,378	1,516	
	Folding	02TC3090T26FD	1,401	1,631	1,770	
30 x 96 *	Static	02TC3096T26	1,147	1,378	1,531	
	Folding	02TC3096T26FD	1,401	1,631	1,784	

fundamental

* \$200 NET surcharge per order for oversized pallet



For Fundamental series table options, please reference pages 54-55.

Rectangular with T-bases	Top Size	Base	Model Number	3P	3K	3W
   	36 x 48	Static	02TC3648T26	\$ 831	\$ 970	\$ 1,084
		Folding	02TC3648T26FD	1,160	1,297	1,411
		Nesting	02TC3648T26NE	1,653	1,791	1,902
	36 x 60	Static	02TC3660T26	916	1,088	1,208
		Folding	02TC3660T26FD	1,257	1,430	1,549
		Nesting	02TC3660T26NE	1,813	1,982	2,099
	36 x 72	Static	02TC3672T26	969	1,163	1,297
		Folding	02TC3672T26FD	1,311	1,505	1,640
		Nesting	02TC3672T26NE	1,892	2,083	2,214
	36 x 84	Static	02TC3684T26	1,174	1,415	1,544
		Folding	02TC3684T26FD	1,426	1,668	1,798
	36 x 90	Static	02TC3690T26	1,257	1,531	1,652
		Folding	02TC3690T26FD	1,510	1,784	1,906
	36 x 96 *	Static	02TC3696T26	1,257	1,531	1,668
		Folding	02TC3696T26FD	1,510	1,784	1,922



Rectangular with TT-bases	Top Size	Base	Model Number	3P	3K	3W
  	42 x 60	Static	02TC4260TT34	\$ 1,229	\$ 1,432	\$ 1,544
		Nesting	02TC4260TT34NE	2,313	2,511	2,621
	42 x 72	Static	02TC4272TT34	1,331	1,573	1,687
		Nesting	02TC4272TT34NE	2,412	2,651	2,762
	42 x 84	Static	02TC4284TT34	1,516	1,797	1,913
	42 x 90	Static	02TC4290TT34	1,609	1,928	2,032
	42 x 96 *	Static	02TC4296TT34	1,609	1,929	2,047
	48 x 60	Static	02TC4860TT36	1,256	1,469	1,590
		Nesting	02TC4860TT36NE	2,340	2,549	2,666
	48 x 72	Static	02TC4872TT36	1,418	1,694	1,798
		Nesting	02TC4872TT36NE	2,497	2,769	2,870
	48 x 84	Static	02TC4884TT36	1,516	1,797	1,928
	48 x 90	Static	02TC4890TT36	1,610	1,930	2,048
	48 x 96 *	Static	02TC4896TT36	1,610	1,930	2,064



* \$200 NET surcharge per order for oversized pallet

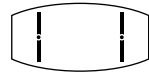

For Fundamental series table options, please reference pages 54-55.

Top Size	Base	Model Number	3P	3K	3W	Rectangular with 3 TT-bases
42 x 120	Static	02TC42120TT34(3)	\$ 2,325	\$ 2,799	\$ 2,864	 
42 x 144	Static	02TC42144TT34(3)	2,519	3,071	3,139	
48 x 120	Static	02TC48120TT36(3)	2,337	2,816	2,892	
48 x 144	Static	02TC48144TT36(3)	2,533	3,091	3,170	

LC CH SH ⊗
 N/A +171 quote 3 bases:

Top Size	Base	Model Number	3P	3K	3W	Boat-shaped with T-bases
30 x 42 x 84	Static	02BT3084T26	\$ 1,527	\$ 1,909	\$ 1,903	 
30 x 42 x 90	Static	02BT3090T26	1,663	2,099	2,067	
30 x 42 x 96 *	Static	02BT3096T26	1,663	2,099	2,083	

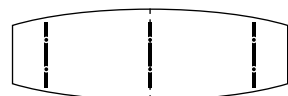
Top Size	Base	Model Number	3P	3K	3W	Boat-shaped with TT-bases
36 x 48 x 84	Static	02BT3684TT34	\$ 1,902	\$ 2,337	\$ 2,299	 
36 x 48 x 90	Static	02BT3690TT34	2,055	2,552	2,484	
36 x 48 x 96 *	Static	02BT3696TT34	2,055	2,552	2,499	

Top Size	Base	Model Number	3P	3K	3W	Boat-shaped with 3 TT-bases
36 x 48 x 120	Static	02BT36120TT36(3)	\$ 2,884	\$ 3,582	\$ 3,440	 
36 x 48 x 144	Static	02BT36144TT36(3)	3,192	4,013	3,842	



LC CH SH ⊗
 N/A +171 quote 3 bases:



* \$200 NET surcharge per order for oversized pallet

For Fundamental series table options, please reference pages 54-55.

fundamental

Race-track with T-bases	Top Size	Base	Model Number	3P	3K	3W
   	36 x 60	Static	02RT3660T26	\$ 1,188	\$ 1,470	\$ 1,468
		Nesting	02RT3660T26NE	2,005	2,281	2,279
	36 x 72	Static	02RT3672T26	1,188	1,470	1,499
		Folding	02RT3672T26FD	1,530	1,813	1,841
		Nesting	02RT3672T26NE	2,081	2,357	2,385
	36 x 84	Static	02RT3684T26	1,524	1,905	1,889
		Folding	02RT3684T26FD	1,777	2,157	2,144
	36 x 90	Static	02RT3690T26	1,663	2,099	2,058
		Folding	02RT3690T26FD	1,916	2,351	2,312
	36 x 96 *	Static	02RT3696T26	1,663	2,099	2,073
		Folding	02RT3696T26FD	1,916	2,351	2,327

Race-track with TT-bases	Top Size	Base	Model Number	3P	3K	3W
 	42 x 84	Static	02RT4284TT34	\$ 2,092	\$ 2,474	\$ 2,467
	42 x 90	Static	02RT4290TT34	2,232	2,667	2,636
	42 x 96 *	Static	02RT4296TT34	2,232	2,667	2,652
	48 x 84	Static	02RT4884TT34	2,385	2,882	2,797
	48 x 90	Static	02RT4890TT34	2,385	2,882	2,812
	48 x 96 *	Static	02RT4896TT34	2,385	2,882	2,828

Race-track with 3 TT-bases	Top Size	Base	Model Number	3P	3K	3W
 	42 x 120	Static	02RT42120TT34(3)	\$ 2,867	\$ 3,558	\$ 3,413
	42 x 144	Static	02RT42144TT34(3)	3,173	3,985	3,811
	48 x 120	Static	02RT48120TT36(3)	2,885	3,583	3,440
	48 x 144	Static	02RT48144TT36(3)	3,192	4,014	3,842
						

* \$200 NET surcharge per order for oversized pallet

For Fundamental series table options, please reference pages 54-55.

Top Size	Base	Model Number	3P	3K	3W	Elliptical with T-bases
30 x 54	Static	02EL3054T22	\$ 926	\$ 1,103	\$ 1,141	
30 x 60	Static	02EL3060T22	973	1,169	1,205	
36 x 60	Static	02EL3660T26	1,076	1,312	1,331	
36 x 72	Static	02EL3672T26	1,188	1,470	1,480	
36 x 84	Static	02EL3684T26	1,396	1,726	1,722	
36 x 90	Static	02EL3690T26	1,509	1,884	1,859	
36 x 96 *	Static	02EL3696T26	1,509	1,884	1,871	

Top Size	Base	Model Number	3P	3K	3W	Elliptical with TT-bases
42 x 72	Static	02EL4272TT26	\$ 1,482	\$ 1,811	\$ 1,796	
42 x 84	Static	02EL4284TT26	1,697	2,079	2,049	
42 x 90	Static	02EL4290TT26	1,839	2,277	2,217	
42 x 96 *	Static	02EL4296TT26	1,839	2,277	2,230	
48 x 72	Static	02EL4872TT30	1,594	1,969	1,932	
48 x 84	Static	02EL4884TT30	1,990	2,487	2,384	
48 x 90	Static	02EL4890TT30	1,990	2,487	2,396	
48 x 96 *	Static	02EL4896TT30	1,990	2,487	2,408	

Top Size	Base	Model Number	3P	3K	3W	Elliptical with 3 TT-bases
42 x 120	Static	02EL42120TT34(3)	\$ 2,867	\$ 3,558	\$ 3,370	
42 x 144	Static	02EL42144TT34(3)	3,173	3,985	3,754	
48 x 120	Static	02EL48120TT36(3)	2,885	3,583	3,401	
48 x 144	Static	02EL48144TT36(3)	3,192	4,014	3,789	



LC CH SH ← ⊗
 N/A +171 quote 3 bases:



* \$200 NET surcharge per order for oversized pallet

For Fundamental series table options, please reference pages 54-55.



fundamental

Square with X-base		Top Size	Base	Model Number	3P	3K	3W
   <p>FT Flip Top X</p>	24 x 24	Static	02SQ2424X22	\$ 494	\$ 541	\$ 630	
		Flip Top	02SQ2424X22FT	657	704	793	
	30 x 30	Static	02SQ3030X26	567	642	742	
		Flip Top	02SQ3030X26FT	731	805	905	
	36 x 36	Static	02SQ3636X32	675	780	888	
		Flip Top	02SQ3636X32FT	837	942	1,050	
	42 x 42	Static	02SQ4242X36	779	919	1,031	
		Flip Top	02SQ4242X36FT	1,021	1,162	1,273	
	48 x 48	Static	02SQ4848X38	905	1,088	1,200	



Square with 4-column X-base		Top Size	Base	Model Number	3P	3K	3W
  	54 x 54	Static	02SQ5454X36.4	\$ 1,284	\$ 1,515	\$ 1,621	
	60 x 60	Static	02SQ6060X42.4	1,554	1,839	1,937	

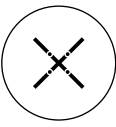

Square with TT-bases		Top Size	Base	Model Number	3P	3K	3W
   <p>NE nesting TT</p>	48 x 48	Static	02SQ4848TT34	\$ 1,183	\$ 1,367	\$ 1,478	
		Nesting	02SQ4848TT34NE	2,267	2,447	2,556	

For Fundamental series table options, please reference pages 54-55.

Top Size	Base	Model Number	3P	3K	3W	Round with X-base
24 x 24	Static	02RD24X22	\$ 534	\$ 598	\$ 647	 
	Flip Top	02RD24X22FT	697	761	810	
30 x 30	Static	02RD30X26	630	728	777	
	Flip Top	02RD30X26FT	793	892	940	
36 x 36	Static	02RD36X30	744	879	923	
	Flip Top	02RD36X30FT	908	1,043	1,087	
42 x 42	Static	02RD42X32	873	1,058	1,090	
	Flip Top	02RD42X32FT	1,117	1,300	1,334	
48 x 48	Static	02RD48X36	919	1,118	1,164	

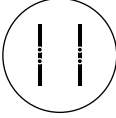
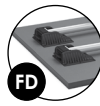

Top Size	Base	Model Number	3P	3K	3W	Round with 4-column X-base
54 x 54	Static	02RD54X32.4	\$ 1,335	\$ 1,613	\$ 1,625	 
60 x 60	Static	02RD60X36.4	1,426	1,715	1,742	

 N/A
  +286
  X.4:

Top Size	Base	Model Number	3P	3K	3W	Round with TT-base	
48 x 48	Static	02RD48TT26	\$ 1,153	\$ 1,352	\$ 1,398	 	
	Nesting	02RD48TT26NE	2,238	2,432	2,478		
54 x 54	Static	02RD54TT30	1,353	1,630	1,642		
	Nesting	02RD54TT30NE	2,433	2,706	2,718		
60 x 60	Static	02RD60TT34	1,446	1,735	1,762		 
	Folding	02RD60TT34FD	2,201	2,490	2,518		
	Nesting	02RD60TT34NE	2,526	2,809	2,835		



For Fundamental series table options, please reference pages 54-55.



fundamental

D-shaped with T-bases	Top Size	Base	Model Number	3P	3K	3W
	24 x 36	Static	02D2436T20	\$ 714	\$ 808	\$ 879
		Nesting	02D2436T20NE	1,407	1,499	1,570
	24 x 48	Static	02D2448T20	792	918	998
		Nesting	02D2448T20NE	1,484	1,606	1,685
	24 x 60	Static	02D2460T20	871	1,027	1,115
		Nesting	02D2460T20NE	1,561	1,714	1,799
	24 x 72	Static	02D2472T20	949	1,137	1,231
		Nesting	02D2472T20NE	1,679	1,863	1,957
	24 x 84	Static	02D2484T20	1,116	1,334	1,437
		Nesting	02D2484T20NE	1,949	2,163	2,263
	24 x 90	Static	02D2490T20	1,154	1,389	1,495
		Nesting	02D2490T20NE	1,987	2,217	2,321
	24 x 96 *	Static	02D2496T20	1,194	1,444	1,553
		Nesting	02D2496T20NE	2,025	2,271	2,378
	30 x 48	Static	02D3048T26	874	1,031	1,099
		Nesting	02D3048T26NE	1,564	1,717	1,784
	30 x 60	Static	02D3060T26	973	1,167	1,238
		Nesting	02D3060T26NE	1,661	1,852	1,921
	30 x 72	Static	02D3072T26	1,070	1,305	1,376
		Nesting	02D3072T26NE	1,798	2,028	2,098
	30 x 84	Static	02D3084T26	1,255	1,530	1,603
		Nesting	02D3084T26NE	2,087	2,355	2,426
	30 x 90	Static	02D3090T26	1,306	1,598	1,672
	30 x 96 *	Static	02D3096T26	1,354	1,666	1,741
	36 x 48	Static	02D3648T26	953	1,140	1,197
		Nesting	02D3648T26NE	1,641	1,824	1,881
	36 x 60	Static	02D3660T26	1,070	1,305	1,357
		Nesting	02D3660T26NE	1,845	2,076	2,128
	36 x 72	Static	02D3672T26	1,187	1,468	1,517
		Nesting	02D3672T26NE	2,078	2,355	2,402
	36 x 84	Static	02D3684T26	1,393	1,720	1,767
	36 x 90	Static	02D3690T26	1,452	1,803	1,845
36 x 96 *	Static	02D3696T26	1,510	1,885	1,926	

* \$200 NET surcharge per order for oversized pallet

For Fundamental series table options, please reference pages 54-55.

Top Size	Base	Model Number	3P	3K	3W	D-shaped with TT-bases
42 x 60	Static	02D4260TT34	\$ 1,774	\$ 2,194	\$ 2,120	 
	Nesting	02D4260TT34NE	2,847	3,259	3,186	
42 x 72	Static	02D4272TT34	1,774	2,194	2,151	
	Nesting	02D4272TT34NE	2,847	3,259	3,217	
42 x 84	Static	02D4284TT34	1,895	2,328	2,306	
42 x 90	Static	02D4290TT34	1,972	2,436	2,408	
42 x 96	Static	02D4296TT34	2,049	2,546	2,508	
48 x 60	Static	02D4860TT36	1,818	2,256	2,180	
	Nesting	02D4860TT36NE	2,889	3,318	3,246	
48 x 72	Static	02D4872TT36	1,818	2,256	2,212	
	Nesting	02D4872TT36NE	2,889	3,318	3,275	
48 x 84	Static	02D4884TT36	1,906	2,344	2,330	
48 x 90	Static	02D4890TT36	1,984	2,453	2,432	
48 x 96	Static	02D4896TT36	2,063	2,562	2,533	

Top Size	Base	Model Number	3P	3K	3W	D-shaped with 4-column X-base
54 x 54	Static	02D5454X36.4	\$ 1,671	\$ 2,058	\$ 2,034	 
60 x 60	Static	02D6060X42.4	1,820	2,211	2,195	

CH N/A	SH +286	X.4: X
-----------	------------	-----------

fundamental

* \$200 NET surcharge per order for oversized pallet

For Fundamental series table options, please reference pages 54-55.

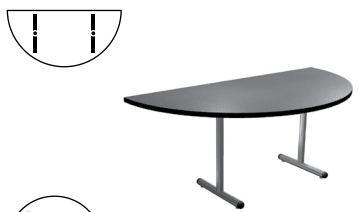
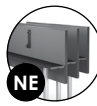
Half Round with T-bases	Top Size	Base	Model Number	3P	3K	3W
 	18 x 36	Static	O2HR1836T16	\$ 721	\$ 819	\$ 866
	24 x 48	Static	O2HR2448T16	792	919	983
		Nesting	O2HR2448T16NE	1,484	1,607	1,671
	30 x 60	Static	O2HR3060T20	970	1,166	1,220
		Nesting	O2HR3060T22NE	1,658	1,850	1,902
	36 x 72	Static	O2HR3672T26	1,186	1,466	1,496
		Nesting	O2HR3672T26NE	2,002	2,277	2,305

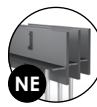
Trapezoid with T-bases	Top Size	Base	Model Number	3P	3K	3W
 	24 x 48	Static	O2TZ2448T18	\$ 782	\$ 903	\$ 973
	24 x 72	Static	O2TZ2472T18	980	1,182	1,271
		Nesting	O2TZ2472T18NE	1,668	1,865	1,952
	30 x 60	Static	O2TZ3060T22	918	1,094	1,162
		Nesting	O2TZ3060T22NE	1,607	1,779	1,846
	36 x 72	Static	O2TZ3672T26	1,158	1,427	1,465
		Nesting	O2TZ3672T26NE	1,974	2,239	2,276

Squircle with X-base	Top Size	Base	Model Number	3P	3K	3W
	24 x 24	Static	O2SL24X22	\$ 714	\$ 851	\$ 873
		Flip Top	O2SL24X22FT	878	1,014	1,036
	30 x 30	Static	O2SL30X26	784	943	979
		Flip Top	O2SL30X26FT	947	1,107	1,142
	36 x 36	Static	O2SL36X32	877	1,064	1,111
		Flip Top	O2SL36X32FT	1,042	1,227	1,274
	42 x 42	Static	O2SL42X36	961	1,176	1,232
		Flip Top	O2SL42X36FT	1,204	1,419	1,475
	48 x 48	Static	O2SL48X38	1,068	1,317	1,379

For Fundamental series table options, please reference pages 54-55.

For Fundamental series table options, please reference pages 54-55.

table~~x~~

06 stretch
price list

Effective January 1, 2023

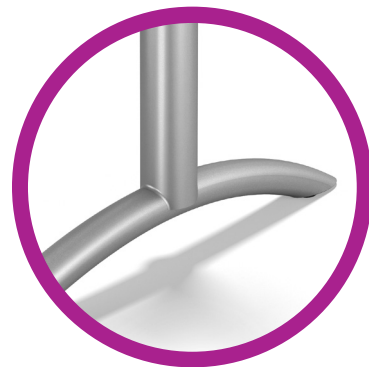



The smoothly curved and sleek look of Stretch makes it a great option for classrooms and training rooms. Its tubular steel construction provides strength and a contemporary design aesthetic.

Stretch Base Styles

stretch

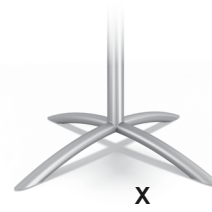
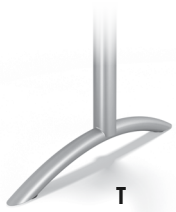

Stretch Options



- LC Locking Casters**
can be added to any table for \$111 per set of four.
- FD Folding Bases**
priced accordingly with standard glides.
- NE Nesting Tables**
priced accordingly with locking casters.
- FT Flip Tops**
available on X-based tables and are priced with standard glides.
- OS Offset T-bases**
available for \$39 per table. Offset is not available on 18"d tables or 30"d nesting tables less than 60" wide.

- CH Chrome Finish**
available for \$130 on most models.
- WM Wire Management**
Built-in wire management is available for \$139 per column. Specify inside or outside of column.
- WM/LC Wire Management Leg Covers**
snap onto any leg and are \$50 each.

- SH Special Height**
can be added to any table:
+ \$72 per column for heights > 29"
+ \$39 per column for heights < 29"
Special height tables with tops larger than 36x72" must be custom quoted.
- FR Footring**
is not available on the Stretch series.
- PB Powerbox Mounting Plate**
is available on X-bases for \$100.

Stretch Height Adjustable Options

AH Spring Clip is available on X-bases for \$139 and on T-bases for \$277 per table. For height option details, see page 19.

Stretch Top Shapes



Rectangle p.72



Boat p.75



Racetrack p.76

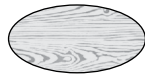

Elliptical p.77



Square p.78



Round p.79



D-shaped p.80



Half Round p.82



Trapezoid p.82



Squircle p.82

Stretch Top Options

QG Quick-Connect Ganging Brackets can be added to any table for \$45 (includes 4 connectors per table).



RC 3" Radius Corners can be added to any table for \$61.

GR Grommets can be added to any table for \$45 each. To see specific locations, see page 227.

Stretch Edge Options

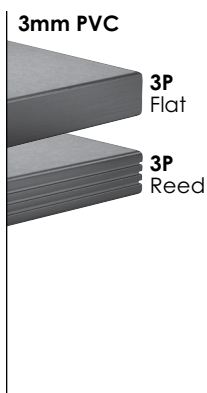
(corresponds with 3 columns of pricing)



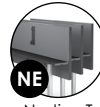



Rectangular with T-bases	Top Size	Base	Model Number	3P	3K	3W
   	20 x 36	Static	06TC2036T18	\$ 714	\$ 786	\$ 877
		Nesting	06TC2036T18NE	1,407	1,477	1,568
	20 x 48	Static	06TC2048T18	771	867	973
		Folding	06TC2048T18FD	1,100	1,194	1,299
		Nesting	06TC2048T18NE	1,464	1,556	1,659
	20 x 60	Static	06TC2060T18	800	902	1,032
		Folding	06TC2060T18FD	1,140	1,245	1,374
		Nesting	06TC2060T18NE	1,489	1,592	1,718
	20 x 72	Static	06TC2072T18	849	973	1,118
		Folding	06TC2072T18FD	1,189	1,314	1,460
		Nesting	06TC2072T18NE	1,774	1,895	2,037
	20 x 84	Static	06TC2084T18	1,033	1,196	1,342
		Folding	06TC2084T18FD	1,287	1,448	1,596
		Nesting	06TC2084T18NE	1,867	2,027	2,172
	20 x 90	Static	06TC2090T18	1,090	1,275	1,422
		Folding	06TC2090T18FD	1,343	1,529	1,674
		Nesting	06TC2090T18NE	1,924	2,106	2,249
	20 x 96 *	Static	06TC2096T18	1,090	1,275	1,438
Folding		06TC2096T18FD	1,343	1,529	1,690	
Nesting		06TC2096T18NE	1,924	2,106	2,264	
24 x 36	Static	06TC2436T22	714	786	889	
	Nesting	06TC2436T22NE	1,407	1,477	1,578	
24 x 48	Static	06TC2448T22	771	867	982	
	Folding	06TC2448T22FD	1,100	1,194	1,311	
	Nesting	06TC2448T22NE	1,464	1,556	1,670	
24 x 60	Static	06TC2460T22	800	902	1,043	
	Folding	06TC2460T22FD	1,140	1,245	1,384	
	Nesting	06TC2460T22NE	1,489	1,592	1,729	
24 x 72	Static	06TC2472T22	849	973	1,128	
	Folding	06TC2472T22FD	1,189	1,314	1,469	
	Nesting	06TC2472T22NE	1,774	1,895	2,048	
24 x 84	Static	06TC2484T22	1,033	1,196	1,354	
	Folding	06TC2484T22FD	1,287	1,448	1,606	
	Nesting	06TC2484T22NE	1,867	2,027	2,181	
24 x 90	Static	06TC2490T22	1,090	1,275	1,432	
	Folding	06TC2490T22FD	1,343	1,529	1,686	
	Nesting	06TC2490T22NE	1,924	2,106	2,259	
24 x 96 *	Static	06TC2496T22	1,090	1,275	1,447	
	Folding	06TC2496T22FD	1,343	1,529	1,701	
	Nesting	06TC2496T22NE	1,924	2,106	2,275	

* \$200 NET surcharge per order for oversized pallet

For Stretch series table options, please reference pages 70-71.



stretch

Top Size	Base	Model Number	3P	3K	3W	Rectangular with T-bases
30 x 36	Static	06TC3036T26	\$ 761	\$ 849	\$ 955	   
	Nesting	06TC3036T26NE	1,453	1,539	1,643	
30 x 48	Static	06TC3048T26	832	948	1,064	
	Folding	06TC3048T26FD	1,161	1,276	1,392	
	Nesting	06TC3048T26NE	1,522	1,637	1,750	
30 x 60	Static	06TC3060T26	854	980	1,119	
	Folding	06TC3060T26FD	1,196	1,320	1,461	
	Nesting	06TC3060T26NE	1,544	1,667	1,803	
30 x 72	Static	06TC3072T26	910	1,057	1,211	
	Folding	06TC3072T26FD	1,251	1,399	1,552	
	Nesting	06TC3072T26NE	1,834	1,979	2,129	
30 x 84	Static	06TC3084T26	1,133	1,335	1,480	
	Folding	06TC3084T26FD	1,386	1,588	1,733	
	Nesting	06TC3084T26NE	1,967	2,165	2,306	
30 x 90	Static	06TC3090T26	1,205	1,436	1,573	
	Folding	06TC3090T26FD	1,459	1,689	1,826	
30 x 96 *	Static	06TC3096T26	1,205	1,436	1,588	
	Folding	06TC3096T26FD	1,459	1,689	1,842	
36 x 48	Static	06TC3648T26	889	1,027	1,141	
	Folding	06TC3648T26FD	1,217	1,355	1,468	
	Nesting	06TC3648T26NE	1,710	1,846	1,958	
36 x 60	Static	06TC3660T26	974	1,145	1,266	
	Folding	06TC3660T26FD	1,315	1,487	1,606	
	Nesting	06TC3660T26NE	1,868	2,039	2,155	
36 x 72	Static	06TC3672T26	1,026	1,221	1,355	
	Folding	06TC3672T26FD	1,368	1,562	1,696	
	Nesting	06TC3672T26NE	1,948	2,138	2,270	
36 x 84	Static	06TC3684T26	1,231	1,472	1,602	
	Folding	06TC3684T26FD	1,485	1,726	1,856	
36 x 90	Static	06TC3690T26	1,315	1,588	1,710	
	Folding	06TC3690T26FD	1,568	1,842	1,963	
36 x 96 *	Static	06TC3696T26	1,315	1,588	1,726	
	Folding	06TC3696T26FD	1,568	1,842	1,979	



* \$200 NET surcharge per order for oversized pallet

For Stretch series table options, please reference pages 70-71.

stretch

Rectangular with TT-bases	Top Size	Base	Model Number	3P	3K	3W
   <p>Nesting TT</p>	42 x 60	Static	06TC4260TT32	\$ 1,376	\$ 1,579	\$ 1,691
		Nesting	06TC4260TT32NE	2,456	2,655	2,765
	42 x 72	Static	06TC4272TT32	1,477	1,719	1,834
		Nesting	06TC4272TT32NE	2,555	2,793	2,905
	42 x 84	Static	06TC4284TT32	1,663	1,944	2,060
	42 x 90	Static	06TC4290TT32	1,756	2,075	2,178
	42 x 96 *	Static	06TC4296TT32	1,756	2,075	2,194
	48 x 60	Static	06TC4860TT36	1,640	1,852	1,972
		Nesting	06TC4860TT36NE	2,715	2,924	3,040
	48 x 72	Static	06TC4872TT36	1,799	2,077	2,179
		Nesting	06TC4872TT36NE	2,872	3,143	3,245
	48 x 84	Static	06TC4884TT36	1,897	2,179	2,309
	48 x 90	Static	06TC4890TT36	1,993	2,313	2,431
	48 x 96 *	Static	06TC4896TT36	1,993	2,313	2,446

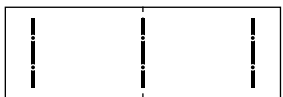
stretch

Rectangular with 3 TT-bases	Top Size	Base	Model Number	3P	3K	3W
  <div style="display: flex; align-items: center; gap: 10px;"> ⊗ → LC CH SH </div> <p>3 bases: N/A +171 quote</p>	42 x 120	Static	06TC42120TT32(3)	\$ 2,546	\$ 3,018	\$ 3,083
	42 x 144	Static	06TC42144TT32(3)	2,739	3,291	3,359
	48 x 120	Static	06TC48120TT36(3)	2,910	3,389	3,465
	48 x 144	Static	06TC48144TT36(3)	3,106	3,664	3,743

* \$200 NET surcharge per order for oversized pallet

For Stretch series table options, please reference pages 70-71.

Top Size	Base	Model Number	3P	3K	3W	Boat-shaped with T-bases
30 x 42 x 84	Static	06BT3084T26	\$ 1,584	\$ 1,967	\$ 1,960	
30 x 42 x 90	Static	06BT3090T26	1,719	2,156	2,125	
30 x 42 x 96 *	Static	06BT3096T26	1,719	2,156	2,139	

Top Size	Base	Model Number	3P	3K	3W	Boat-shaped with TT-bases
36 x 48 x 84	Static	06BT3684TT32	\$ 2,047	\$ 2,483	\$ 2,445	
36 x 48 x 90	Static	06BT3690TT32	2,201	2,699	2,631	
36 x 48 x 96 *	Static	06BT3696TT32	2,201	2,699	2,645	

Top Size	Base	Model Number	3P	3K	3W	Boat-shaped with 3 TT-bases
36 x 48 x 120	Static	06BT36120TT36(3)	\$ 3,457	\$ 4,155	\$ 4,014	
36 x 48 x 144	Static	06BT36144TT36(3)	3,765	4,586	4,415	



LC CH SH ← ⊗
 N/A +171 quote 3 bases:



stretch

* \$200 NET surcharge per order for oversized pallet

For Stretch series table options, please reference pages 70-71.

Racetrack with T-bases	Top Size	Base	Model Number	3P	3K	3W
   FD Folding T  NE Nesting T	36 x 60	Static	06RT3660T26	\$ 1,246	\$ 1,528	\$ 1,526
		Nesting	06RT3660T26NE	2,062	2,337	2,335
	36 x 72	Static	06RT3672T26	1,246	1,528	1,557
		Folding	06RT3672T26FD	1,587	1,869	1,899
		Nesting	06RT3672T26NE	2,136	2,413	2,441
	36 x 84	Static	06RT3684T26	1,581	1,962	1,948
		Folding	06RT3684T26FD	1,835	2,215	2,200
	36 x 90	Static	06RT3690T26	1,719	2,156	2,115
		Folding	06RT3690T26FD	1,973	2,409	2,369
	36 x 96 *	Static	06RT3696T26	1,719	2,156	2,131
		Folding	06RT3696T26FD	1,973	2,409	2,385

Racetrack with TT-bases	Top Size	Base	Model Number	3P	3K	3W
 	42 x 84	Static	06RT4284TT32	\$ 1,910	\$ 2,291	\$ 2,285
	42 x 90	Static	06RT4290TT32	2,049	2,485	2,453
	42 x 96 *	Static	06RT4296TT32	2,049	2,485	2,468
	48 x 84	Static	06RT4884TT36	2,438	2,935	2,850
	48 x 90	Static	06RT4890TT36	2,438	2,935	2,866
	48 x 96 *	Static	06RT4896TT36	2,438	2,935	2,882

Racetrack with 3 TT-bases	Top Size	Base	Model Number	3P	3K	3W
 	42 x 120	Static	06RT42120TT32(3)	\$ 3,086	\$ 3,778	\$ 3,632
	42 x 144	Static	06RT42144TT32(3)	3,392	4,205	4,030
	48 x 120	Static	06RT48120TT36(3)	3,457	4,155	4,014
	48 x 144	Static	06RT48144TT36(3)	3,766	4,587	4,416

 → **LC** **CH** **SH**
 3 bases: N/A +171 quote

* \$200 NET surcharge per order for oversized pallet

For Stretch series table options, please reference pages 70-71.

stretch

Top Size	Base	Model Number	3P	3K	3W	Elliptical with T-bases
30 x 54	Static	06EL3054T22	\$ 982	\$ 1,161	\$ 1,199	
30 x 60	Static	06EL3060T22	1,029	1,227	1,263	
36 x 60	Static	06EL3660T26	1,133	1,370	1,388	
36 x 72	Static	06EL3672T26	1,246	1,528	1,537	
36 x 84	Static	06EL3684T26	1,453	1,782	1,779	
36 x 90	Static	06EL3690T26	1,566	1,941	1,916	
36 x 96 *	Static	06EL3696T26	1,566	1,941	1,928	

Top Size	Base	Model Number	3P	3K	3W	Elliptical with TT-bases
42 x 72	Static	06EL4272TT26	\$ 1,693	\$ 2,023	\$ 2,007	
42 x 84	Static	06EL4284TT26	1,910	2,291	2,262	
42 x 90	Static	06EL4290TT26	2,051	2,488	2,430	
42 x 96 *	Static	06EL4296TT26	2,051	2,488	2,442	
48 x 72	Static	06EL4872TT32	1,806	2,181	2,145	
48 x 84	Static	06EL4884TT32	2,202	2,700	2,595	
48 x 90	Static	06EL4890TT32	2,202	2,700	2,608	
48 x 96 *	Static	06EL4896TT32	2,202	2,700	2,619	



Top Size	Base	Model Number	3P	3K	3W	Elliptical with 3 TT-bases
42 x 120	Static	06EL42120TT26(3)	\$ 3,086	\$ 3,778	\$ 3,589	
42 x 144	Static	06EL42144TT26(3)	3,392	4,205	3,975	
48 x 120	Static	06EL48120TT36(3)	3,457	4,155	3,975	
48 x 144	Static	06EL48144TT36(3)	3,766	4,587	4,362	

LC CH SH ← ⊗
 N/A +171 quote 3 bases:



* \$200 NET surcharge per order for oversized pallet

For Stretch series table options, please reference pages 70-71.

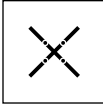

stretch

Square with X-base	Top Size	Base	Model Number	3P	3K	3W
 	24 x 24	Static	06SQ2424X22	\$ 726	\$ 774	\$ 864
		Flip Top	06SQ2424X22FT	890	937	1,026
	30 x 30	Static	06SQ3030X26	792	867	966
		Flip Top	06SQ3030X26FT	956	1,029	1,130
	36 x 36	Static	06SQ3636X32	923	1,028	1,137
		Flip Top	06SQ3636X32FT	1,087	1,191	1,299

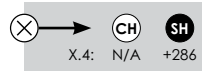

Square with 4-column X-base	Top Size	Base	Model Number	3P	3K	3W
 	42 x 42	Static	06SQ4242X36.4	\$ 1,706	\$ 1,846	\$ 1,958
	48 x 48	Static	06SQ4848X36.4	1,812	1,994	2,106
	54 x 54	Static	06SQ5454X36.4	1,930	2,161	2,267







Square with TT-bases	Top Size	Base	Model Number	3P	3K	3W
 	48 x 48	Static	06SQ4848TT32	\$ 1,330	\$ 1,514	\$ 1,624
		Nesting	06SQ4848TT32NE	2,411	2,591	2,700





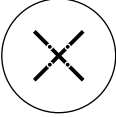

For Stretch series table options, please reference pages 70-71.

stretch

Top Size	Base	Model Number	3P	3K	3W	Round with X-base
24 x 24	Static	06RD24X22	\$ 766	\$ 830	\$ 879	  
	Flip Top	06RD24X22FT	930	993	1,043	
30 x 30	Static	06RD30X26	855	954	1,002	
	Flip Top	06RD30X26FT	1,019	1,117	1,165	
36 x 36	Static	06RD36X32	1,000	1,136	1,181	
	Flip Top	06RD36X32FT	1,163	1,298	1,343	
42 x 42	Static	06RD42X32	1,122	1,307	1,339	
	Flip Top	06RD42X32FT	1,364	1,550	1,582	

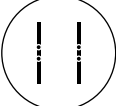

Top Size	Base	Model Number	3P	3K	3W	Round with 4-column X-base
48 x 48	Static	06RD48X36.4	\$ 1,846	\$ 2,045	\$ 2,091	 
54 x 54	Static	06RD54X36.4	2,046	2,324	2,335	
60 x 60	Static	06RD60X36.4	2,073	2,363	2,390	

 N/A
  +286
  X.4:

Top Size	Base	Model Number	3P	3K	3W	Round with TT-base
48 x 48	Static	06RD48TT26	\$ 1,365	\$ 1,563	\$ 1,610	   
	Nesting	06RD48TT26NE	2,446	2,640	2,686	
54 x 54	Static	06RD54TT32	1,564	1,843	1,855	
	Nesting	06RD54TT32NE	2,641	2,914	2,926	
60 x 60	Static	06RD60TT32	1,593	1,882	1,909	
	Folding	06RD60TT32FD	2,348	2,637	2,664	
	Nesting	06RD60TT32NE	2,669	2,952	2,979	



For Stretch series table options, please reference pages 70-71.

stretch

D-shaped with T-bases	Top Size	Base	Model Number	3P	3K	3W
	24 x 36	Static	06D2436T22	\$ 771	\$ 866	\$ 937
		Nesting	06D2436T22NE	1,464	1,556	1,626
	24 x 48	Static	06D2448T22	850	975	1,055
		Nesting	06D2448T22NE	1,540	1,663	1,740
	24 x 60	Static	06D2460T22	929	1,085	1,172
		Nesting	06D2460T22NE	1,617	1,771	1,856
	24 x 72	Static	06D2472T22	1,006	1,194	1,289
		Nesting	06D2472T22NE	1,735	1,919	2,013
 NE Nesting T	24 x 84	Static	06D2484T22	1,173	1,392	1,494
		Nesting	06D2484T22NE	2,005	2,219	2,320
	24 x 90	Static	06D2490T22	1,211	1,446	1,552
		Nesting	06D2490T22NE	2,043	2,274	2,377
	24 x 96 *	Static	06D2496T22	1,251	1,502	1,610
		Nesting	06D2496T22NE	2,082	2,327	2,434
	30 x 48	Static	06D3048T26	932	1,088	1,157
		Nesting	06D3048T26NE	1,621	1,774	1,841
	30 x 60	Static	06D3060T26	1,029	1,225	1,295
		Nesting	06D3060T26NE	1,716	1,908	1,977
	30 x 72	Static	06D3072T26	1,128	1,361	1,433
		Nesting	06D3072T26NE	1,855	2,085	2,155
	30 x 84	Static	06D3084T26	1,313	1,587	1,661
		Nesting	06D3084T26NE	2,144	2,411	2,484
	30 x 90	Static	06D3090T26	1,362	1,654	1,730
	30 x 96 *	Static	06D3096T26	1,411	1,724	1,799
	36 x 48	Static	06D3648T26	1,010	1,197	1,254
		Nesting	06D3648T26NE	1,696	1,881	1,937
	36 x 60	Static	06D3660T26	1,128	1,361	1,415
		Nesting	06D3660T26NE	1,902	2,132	2,183
	36 x 72	Static	06D3672T26	1,245	1,526	1,574
		Nesting	06D3672T26NE	2,134	2,411	2,459
	36 x 84	Static	06D3684T26	1,449	1,778	1,823
	36 x 90	Static	06D3690T26	1,509	1,861	1,903
36 x 96 *	Static	06D3696T26	1,568	1,943	1,983	

* \$200 NET surcharge per order for oversized pallet

For Stretch series table options, please reference pages 70-71.

Top Size	Base	Model Number	3P	3K	3W	D-shaped with TT-bases
42 x 60	Static	06D4260TT32	\$ 1,921	\$ 2,341	\$ 2,266	 
	Nesting	06D4260TT32NE	2,990	3,402	3,329	
42 x 72	Static	06D4272TT32	1,921	2,341	2,298	
	Nesting	06D4272TT32NE	2,990	3,402	3,360	
42 x 84	Static	06D4284TT32	2,042	2,475	2,453	
42 x 90	Static	06D4290TT32	2,119	2,583	2,553	
42 x 96 *	Static	06D4296TT32	2,196	2,691	2,655	
48 x 60	Static	06D4860TT36	2,199	2,637	2,562	
	Nesting	06D4860TT36NE	3,264	3,693	3,620	
48 x 72	Static	06D4872TT36	2,199	2,637	2,593	
	Nesting	06D4872TT36NE	3,264	3,693	3,650	
48 x 84	Static	06D4884TT36	2,287	2,725	2,713	
48 x 90	Static	06D4890TT36	2,366	2,835	2,814	
48 x 96 *	Static	06D4896TT36	2,444	2,945	2,916	

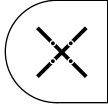
Top Size	Base	Model Number	3P	3K	3W	D-shaped with 4-column X-base
54 x 54	Static	06D5454X36.4	\$ 2,319	\$ 2,705	\$ 2,680	 

CH	SH	←	⊗
N/A	+286	X.4:	

stretch

* \$200 NET surcharge per order for oversized pallet

For Stretch series table options, please reference pages 70-71.

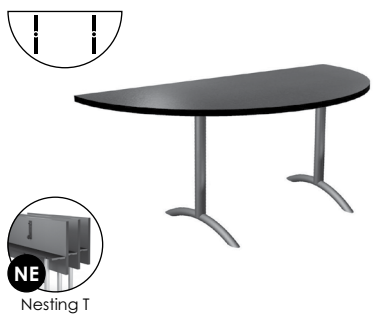
Half Round with T-bases	Top Size	Base	Model Number	3P	3K	3W
 <p>NE Nesting T</p>	24 x 48	Static	06HR2448T18	\$ 853	\$ 980	\$ 1,045
		Nesting	06HR2448T18NE	1,543	1,668	1,732
	30 x 60	Static	06HR3060T22	1,027	1,224	1,276
		Nesting	06HR3060T22NE	1,714	1,906	1,958
	36 x 72	Static	06HR3672T26	1,244	1,524	1,553
		Nesting	06HR3672T26NE	2,058	2,333	2,362

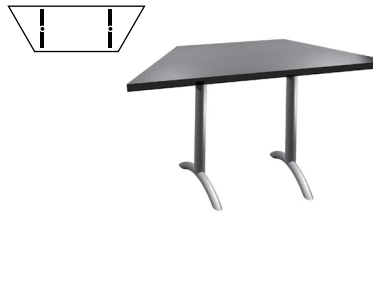
Trapezoid with T-bases	Top Size	Base	Model Number	3P	3K	3W
	24 x 48	Static	06TZ2448T18	\$ 844	\$ 965	\$ 1,034
	24 x 72	Static	06TZ2472T18	1,042	1,244	1,332
		Nesting	06TZ2472T18NE	1,728	1,926	2,013
	30 x 60	Static	06TZ3060T22	976	1,151	1,220
		Nesting	06TZ3060T22NE	1,664	1,836	1,903
	36 x 72	Static	06TZ3672T26	1,215	1,485	1,522
Nesting		06TZ3672T26NE	1,993	2,258	2,294	

Sqircle with X-base	Top Size	Base	Model Number	3P	3K	3W
	24 x 24	Static	06SL24X22	\$ 947	\$ 1,084	\$ 1,106
		Flip Top	06SL24X22FT	1,110	1,247	1,269
	30 x 30	Static	06SL30X26	1,008	1,168	1,204
		Flip Top	06SL30X26FT	1,172	1,332	1,367
	36 x 36	Static	06SL36X32	1,127	1,313	1,359
		Flip Top	06SL36X32FT	1,290	1,476	1,524
42 x 42	Static	06SL42X32	1,199	1,414	1,469	
	Flip Top	06SL42X32FT	1,441	1,656	1,713	

For Stretch series table options, please reference pages 70-71.

For Stretch series table options, please reference pages 70-71.

table 

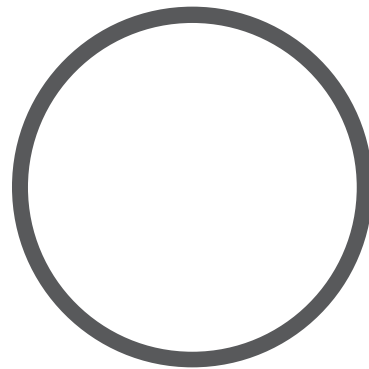

08 elite
price list
Effective January 1, 2023

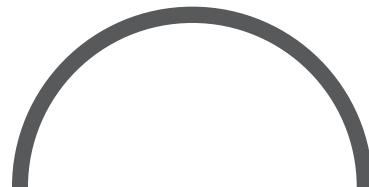



Elite exudes a contemporary style and provides you with our most flexible offering. Its welded base construction delivers lasting functionality without sacrificing beauty.

Elite Base Styles

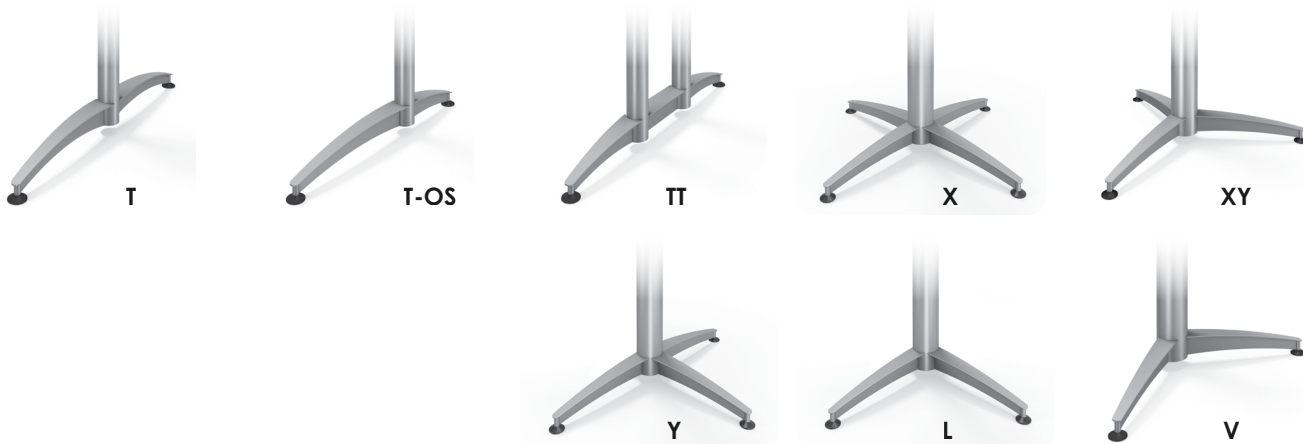

Elite Options

Standard Plastic Glides



Locking Casters



LC **Locking Casters**
can be added to any table for \$111 per set of four.

FD **Folding Bases**
priced accordingly with standard glides.

NE **Nesting Tables**
priced accordingly with locking casters.

FT **Flip Tops**
available on X-based tables and are priced with standard glides.

CH **Chrome Finish**
is not available on Elite tables.

WM **Wire Management**
Built-in wire management is available for \$139 per column. Specify inside or outside of column.

WM LC **2" Wire Management Leg Covers**
snap onto any leg and are \$50 each.

WM LC **3" Wire Management Leg Covers**
snap onto any leg and are \$79 each. 3" required for X, XY, Y, L base styles.

PB **Powerbox Mounting Plate**
is available on X-bases for \$100.

FR **Footring**
is not available on the Elite series.

OS **Offset T-bases**
available for \$39 per table. Offset is not available on 18"d tables or 30"d nesting tables less than 60" wide.

SH **Special Height**
can be added to any table:
+ \$72 per column for heights > 29"
+ \$39 per column for heights < 29"
Special height tables with tops larger than 36x72" must be custom quoted.

elite

Elite Height Adjustable Options

AH Spring Clip is available on X-bases for \$139 and on T-bases for \$277 per table. For height option details, see page 19.

Elite Top Shapes



Rectangle
p.88



Boat
p.93

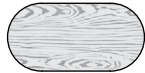

Racetrack
p.94

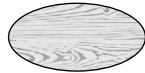

Elliptical
p.95



Square
p.96



Round
p.97

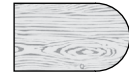

D-shaped
p.98



Half Round
p.100



Trapezoid
p.100



Squircle
p.100

Elite Top Options

QG Quick-Connect Ganging Brackets can be added to any table for \$45 (includes 4 connectors per table).

RC 3" Radius Corners can be added to any table for \$61.

GR Grommets can be added to any table for \$45 each. To see specific locations, see page 227.

Elite Edge Options

(corresponds with 3 columns of pricing)

3mm PVC

3P Flat





3P Reed

3mm PVC

3K Knife





3mm Wood

3W Flat

Rectangular with T-bases	Top Size	Base	Model Number	3P	3K	3W
   	20 x 36	Static	08TC2036T18	\$ 867	\$ 938	\$1,029
		Nesting	08TC2036T18NE	1,557	1,626	1,716
	20 x 48	Static	08TC2048T18	923	1,019	1,124
		Folding	08TC2048T18FD	1,252	1,346	1,452
		Nesting	08TC2048T18NE	1,613	1,706	1,809
	20 x 60	Static	08TC2060T18	952	1,055	1,184
		Folding	08TC2060T18FD	1,292	1,397	1,526
		Nesting	08TC2060T18NE	1,640	1,741	1,867
	20 x 72	Static	08TC2072T18	1,001	1,124	1,270
		Folding	08TC2072T18FD	1,341	1,466	1,612
		Nesting	08TC2072T18NE	1,923	2,045	2,188
	20 x 84	Static	08TC2084T18	1,185	1,349	1,495
		Folding	08TC2084T18FD	1,439	1,601	1,749
		Nesting	08TC2084T18NE	2,016	2,176	2,321
	20 x 90	Static	08TC2090T18	1,243	1,427	1,574
		Folding	08TC2090T18FD	1,496	1,682	1,826
		Nesting	08TC2090T18NE	2,072	2,256	2,398
	20 x 96 *	Static	08TC2096T18	1,243	1,427	1,590
Folding		08TC2096T18FD	1,496	1,682	1,842	
Nesting		08TC2096T18NE	2,072	2,256	2,413	
24 x 36	Static	08TC2436T22	867	938	1,040	
	Nesting	08TC2436T22NE	1,557	1,626	1,727	
24 x 48	Static	08TC2448T22	923	1,019	1,134	
	Folding	08TC2448T22FD	1,252	1,346	1,463	
	Nesting	08TC2448T22NE	1,613	1,706	1,819	
24 x 60	Static	08TC2460T22	952	1,055	1,195	
	Folding	08TC2460T22FD	1,292	1,397	1,537	
	Nesting	08TC2460T22NE	1,640	1,741	1,879	
24 x 72	Static	08TC2472T22	1,001	1,124	1,279	
	Folding	08TC2472T22FD	1,341	1,466	1,622	
	Nesting	08TC2472T22NE	1,923	2,045	2,197	
24 x 84	Static	08TC2484T22	1,185	1,349	1,506	
	Folding	08TC2484T22FD	1,439	1,601	1,758	
	Nesting	08TC2484T22NE	2,016	2,176	2,331	
24 x 90	Static	08TC2490T22	1,243	1,427	1,584	
	Folding	08TC2490T22FD	1,496	1,682	1,838	
	Nesting	08TC2490T22NE	2,072	2,256	2,409	
24 x 96 *	Static	08TC2496T22	1,243	1,427	1,600	
	Folding	08TC2496T22FD	1,496	1,682	1,853	
	Nesting	08TC2496T22NE	2,072	2,256	2,423	



* \$200 NET surcharge per order for oversized pallet

For Elite series table options, please reference pages 86-87.

Top Size	Base	Model Number	3P	3K	3W	Rectangular with T-bases
30 x 36	Static	08TC3036T26	\$ 921	\$ 1,010	\$ 1,115	   
	Nesting	08TC3036T26NE	1,610	1,696	1,800	
30 x 48	Static	08TC3048T26	993	1,109	1,224	
	Folding	08TC3048T26FD	1,320	1,438	1,552	
30 x 60	Nesting	08TC3048T26NE	1,680	1,795	1,907	
	Static	08TC3060T26	1,015	1,140	1,279	
	Folding	08TC3060T26FD	1,357	1,482	1,622	
30 x 72	Nesting	08TC3060T26NE	1,703	1,824	1,961	
	Static	08TC3072T26	1,070	1,218	1,372	
	Folding	08TC3072T26FD	1,412	1,560	1,713	
30 x 84	Nesting	08TC3072T26NE	1,991	2,136	2,286	
	Static	08TC3084T26	1,294	1,496	1,641	
	Folding	08TC3084T26FD	1,548	1,750	1,894	
30 x 90	Nesting	08TC3084T26NE	2,125	2,322	2,464	
	Static	08TC3090T26	1,365	1,596	1,734	
	Folding	08TC3090T26FD	1,620	1,848	1,988	
30 x 96 *	Static	08TC3096T26	1,365	1,596	1,750	
	Folding	08TC3096T26FD	1,620	1,848	2,003	
36 x 48	Static	08TC3648T26	1,049	1,188	1,301	
	Folding	08TC3648T26FD	1,377	1,516	1,629	
	Nesting	08TC3648T26NE	1,867	2,004	2,115	
36 x 60	Static	08TC3660T26	1,134	1,307	1,425	
	Folding	08TC3660T26FD	1,475	1,648	1,768	
	Nesting	08TC3660T26NE	2,026	2,196	2,313	
36 x 72	Static	08TC3672T26	1,187	1,381	1,516	
	Folding	08TC3672T26FD	1,529	1,724	1,858	
	Nesting	08TC3672T26NE	2,106	2,297	2,428	
36 x 84	Static	08TC3684T26	1,393	1,632	1,762	
	Folding	08TC3684T26FD	1,645	1,886	2,016	
	Nesting	08TC3684T26NE	1,476	1,750	1,871	
36 x 90	Static	08TC3690T26	1,729	2,003	2,125	
	Folding	08TC3690T26FD	1,476	1,750	1,886	
36 x 96 *	Static	08TC3696T26	1,729	2,003	2,139	
	Folding	08TC3696T26FD	1,646	1,907	2,037	



* \$200 NET surcharge per order for oversized pallet



For Elite series table options, please reference pages 86-87.

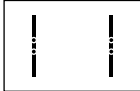

Rectangular with V-bases	Top Size	Base	Model Number	3P	3K	3W
 	24 x 48	Static	08TC2448V22	\$ 1,111	\$ 1,205	\$ 1,320
		Nesting	08TC2448V22NE	1,796	1,888	2,002
	24 x 60	Static	08TC2460V22	1,138	1,243	1,381
		Nesting	08TC2460V22NE	1,822	1,925	2,062
	24 x 72	Static	08TC2472V22	1,187	1,312	1,467
		Nesting	08TC2472V22NE	2,106	2,228	2,380
	24 x 84	Static	08TC2484V22	1,372	1,535	1,692
		Nesting	08TC2484V22NE	2,199	2,359	2,514
	24 x 90	Static	08TC2490V22	1,428	1,615	1,771
		Nesting	08TC2490V22NE	2,256	2,439	2,592
	24 x 96 *	Static	08TC2496V22	1,428	1,615	1,785
		Nesting	08TC2496V22NE	2,256	2,439	2,607
	30 x 48	Static	08TC3048V26	1,210	1,327	1,441
		Nesting	08TC3036V26NE	1,893	2,007	2,120
	30 x 60	Static	08TC3060V26	1,232	1,357	1,497
		Nesting	08TC3060V26NE	1,915	2,039	2,174
	30 x 72	Static	08TC3072V26	1,288	1,436	1,588
		Nesting	08TC3072V26NE	2,204	2,349	2,501
	30 x 84	Static	08TC3084V26	1,511	1,713	1,858
		Nesting	08TC3084V26NE	2,337	2,535	2,677
	30 x 90	Static	08TC3090V26	1,583	1,814	1,951
	30 x 96 *	Static	08TC3096V26	1,583	1,814	1,967
	36 x 48	Static	08TC3648V32	1,339	1,478	1,592
		Nesting	08TC3648V32NE	2,153	2,288	2,400
	36 x 60	Static	08TC3660V32	1,424	1,598	1,716
		Nesting	08TC3660V32NE	2,310	2,481	2,597
	36 x 72	Static	08TC3672V32	1,478	1,672	1,805
		Nesting	08TC3672V32NE	2,391	2,580	2,713
	36 x 84	Static	08TC3684V32	1,683	1,923	2,054
	36 x 90	Static	08TC3690V32	1,767	2,041	2,160
	36 x 96 *	Static	08TC3696V32	1,767	2,041	2,176

* \$200 NET surcharge per order for oversized pallet

For Elite series table options, please reference pages 86-87.

Top Size	Base	Model Number	3P	3K	3W	Rectangle with TT-bases
42 x 60	Static	08TC4260TT32	\$ 1,652	\$ 1,856	\$ 1,968	  
	Nesting	08TC4260TT32NE	2,727	2,926	3,037	
42 x 72	Static	08TC4272TT32	1,754	1,997	2,110	
	Nesting	08TC4272TT32NE	2,827	3,064	3,176	
42 x 84	Static	08TC4284TT32	1,939	2,220	2,336	
42 x 90	Static	08TC4290TT32	2,033	2,351	2,455	
42 x 96 *	Static	08TC4296TT32	2,033	2,351	2,470	
48 x 60	Static	08TC4860TT32	1,680	1,893	2,013	
	Nesting	08TC4860TT32NE	2,755	2,964	3,081	
48 x 72	Static	08TC4872TT32	1,841	2,117	2,221	
	Nesting	08TC4872TT32NE	2,911	3,184	3,285	
48 x 84	Static	08TC4884TT32	1,939	2,220	2,351	
48 x 90	Static	08TC4890TT32	2,034	2,354	2,472	
48 x 96 *	Static	08TC4896TT32	2,034	2,354	2,487	

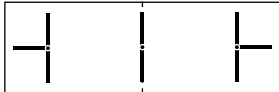
Top Size	Base	Model Number	3P	3K	3W	Rectangle with Y-bases
42 x 60	Static	08TC4260Y36	\$ 1,797	\$ 2,000	\$ 2,112	 
42 x 72	Static	08TC4272Y36	1,899	2,141	2,255	
42 x 84	Static	08TC4284Y36	1,995	2,277	2,392	
42 x 90	Static	08TC4290Y36	2,089	2,409	2,511	
42 x 96 *	Static	08TC4296Y36	2,089	2,409	2,527	
48 x 60	Static	08TC4860Y36	1,824	2,039	2,157	
48 x 72	Static	08TC4872Y36	1,985	2,262	2,366	
48 x 84	Static	08TC4884Y36	1,995	2,277	2,408	
48 x 90	Static	08TC4890Y36	2,090	2,410	2,528	
48 x 96 *	Static	08TC4896Y36	2,090	2,410	2,544	

Top Size	Base	Model Number	3P	3K	3W	Rectangle with Y & T-bases
42 x 120	Static	08TC42120Y36T36	\$ 2,907	\$ 3,381	\$ 3,446	 
42 x 144	Static	08TC42144Y36T36	3,101	3,652	3,721	
48 x 120	Static	08TC48120Y36T36	2,919	3,398	3,474	
48 x 144	Static	08TC48144Y36T36	3,116	3,672	3,752	

LC SH ← ⊗
N/A quote 3 bases:

* \$200 NET surcharge per order for oversized pallet

For Elite series table options, please reference pages 86-87.

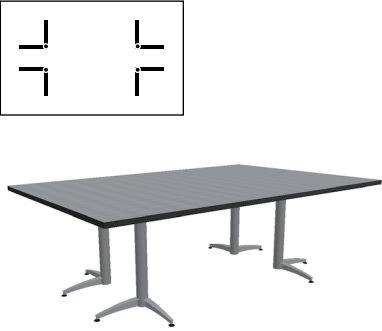
Rectangular with L-bases	Top Size	Base	Model Number	3P	3K	3W
	54 x 60	Static	08TC5460L26	\$ 2,510	\$ 2,770	\$ 2,871
	54 x 72	Static	08TC5472L26	2,640	2,952	3,045
	54 x 84	Static	08TC5484L26	2,770	3,135	3,219
	54 x 90	Static	08TC5490L26	2,835	3,226	3,306
	54 x 96 *	Static	08TC5496L26	2,901	3,316	3,393
	60 x 72	Static	08TC6072L26	2,727	3,074	3,157
	60 x 84	Static	08TC6084L26	2,872	3,276	3,346
	60 x 90	Static	08TC6090L26	2,944	3,377	3,440
	60 x 96 *	Static	08TC6096L26	3,016	3,478	3,536

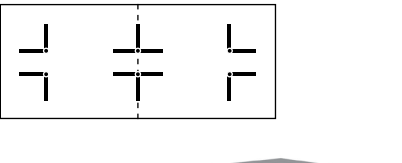

⊗ → LC SH
4 bases: +200 quote

Rectangular with L & Y-bases	Top Size	Base	Model Number	3P	3K	3W
	54 x 120	Static	08TC54120L26Y26	\$ 4,372	\$ 4,961	\$ 4,970
	54 x 144	Static	08TC54144L26Y26	4,631	5,325	5,318
	60 x 120	Static	08TC60120L26Y26	4,493	5,132	5,120
	60 x 144	Static	08TC60144L26Y26	4,804	5,568	5,525

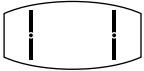

⊗ → LC SH
3 bases: N/A N/A

* \$200 NET surcharge per order for oversized pallet



For Elite series table options, please reference pages 86-87.

Top Size	Base	Model Number	3P	3K	3W	Boat-shaped with T-bases
30 x 42 x 84	Static	08BT3084T26	\$ 1,746	\$ 2,128	\$ 2,121	 
30 x 42 x 90	Static	08BT3090T26	1,881	2,318	2,285	
30 x 42 x 96 *	Static	08BT3096T26	1,881	2,318	2,301	

Top Size	Base	Model Number	3P	3K	3W	Boat-shaped with Y-bases
36 x 48 x 84	Static	08BT3684Y26	\$ 2,282	\$ 2,718	\$ 2,679	 
36 x 48 x 90	Static	08BT3690Y26	2,436	2,933	2,864	
36 x 48 x 96 *	Static	08BT3696Y26	2,436	2,933	2,880	

Top Size	Base	Model Number	3P	3K	3W	Boat-shaped with Y & T-bases
36 x 48 x 120	Static	08BT36120Y26T32	\$ 3,329	\$ 4,026	\$ 3,885	 
36 x 48 x 144	Static	08BT36144Y26T32	3,637	4,459	4,287	

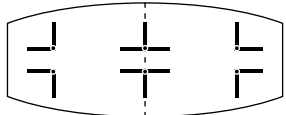
LC SH ← X
N/A quote 3 bases:

Top Size	Base	Model Number	3P	3K	3W	Boat-shaped with L & Y-bases
42 x 54 x 120	Static	08BT42120L26Y26	\$ 4,834	\$ 5,606	\$ 5,417	 
42 x 54 x 144	Static	08BT42144L26Y26	5,042	5,898	5,708	
48 x 60 x 120	Static	08BT48120L26Y26	4,867	5,656	5,465	
48 x 60 x 144	Static	08BT48144L26Y26	5,081	5,956	5,762	



LC SH ← X
N/A N/A 3 bases:



* \$200 NET surcharge per order for oversized pallet

For Elite series table options, please reference pages 86-87.

Race rack with T-bases	Top Size	Base	Model Number	3P	3K	3W
   	36 x 60	Static	08RT3660T26	\$1,406	\$1,689	\$1,687
		Nesting	08RT3660T26NE	2,219	2,496	2,492
	36 x 72	Static	08RT3672T26	1,406	1,689	1,717
		Folding	08RT3672T26FD	1,749	2,031	2,060
		Nesting	08RT3672T26NE	2,294	2,571	2,598
	36 x 84	Static	08RT3684T26	1,741	2,124	2,108
		Folding	08RT3684T26FD	1,995	2,376	2,362
	36 x 90	Static	08RT3690T26	1,881	2,318	2,277
		Folding	08RT3690T26FD	2,134	2,570	2,529
	36 x 96 *	Static	08RT3696T26	1,881	2,318	2,292
		Folding	08RT3696T26FD	2,134	2,570	2,546

Race rack with Y-bases	Top Size	Base	Model Number	3P	3K	3W
 	42 x 84	Static	08RT4284Y32	\$2,210	\$2,590	\$2,585
	42 x 90	Static	08RT4290Y32	2,348	2,784	2,751
	42 x 96 *	Static	08RT4296Y32	2,348	2,784	2,768
	48 x 84	Static	08RT4884Y36	2,534	3,032	2,948
	48 x 90	Static	08RT4890Y36	2,534	3,032	2,964
	48 x 96 *	Static	08RT4896Y36	2,534	3,032	2,979

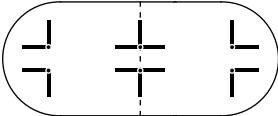
Race rack with Y & T-bases	Top Size	Base	Model Number	3P	3K	3W
  	42 x 120	Static	08RT42120Y32T32	\$2,985	\$3,674	\$3,531
	42 x 144	Static	08RT42144Y32T32	3,289	4,102	3,929
	48 x 120	Static	08RT48120Y36T36	3,036	3,733	3,591
	48 x 144	Static	08RT48144Y36T36	3,344	4,165	3,994

Race rack with L & Y-bases	Top Size	Base	Model Number	3P	3K	3W
  	54 x 120	Static	08RT54120L26Y26	\$3,986	\$4,838	\$4,590
	54 x 144	Static	08RT54144L26Y26	4,299	5,276	4,996
	60 x 120	Static	08RT60120L26Y26	3,986	4,838	4,598
	60 x 144	Static	08RT60144L26Y26	4,299	5,276	5,005

* \$200 NET surcharge per order for oversized pallet

For Elite series table options, please reference pages 86-87.

Top Size	Base	Model Number	3P	3K	3W	Elliptical with T-bases
30 x 54	Static	08EL3054T22	\$ 1,134	\$ 1,313	\$ 1,351	
30 x 60	Static	08EL3060T22	1,182	1,379	1,415	
36 x 60	Static	08EL3660T26	1,294	1,530	1,548	
36 x 72	Static	08EL3672T26	1,406	1,689	1,697	
36 x 84	Static	08EL3684T26	1,614	1,944	1,940	
36 x 90	Static	08EL3690T26	1,728	2,102	2,077	
36 x 96 *	Static	08EL3696T26	1,728	2,102	2,089	

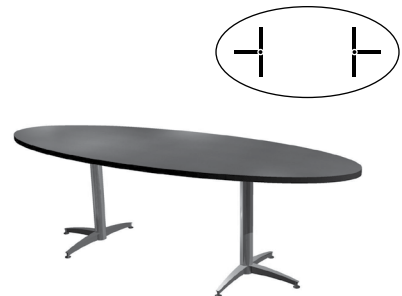
Top Size	Base	Model Number	3P	3K	3W	Elliptical with Y-bases
42 x 72	Static	08EL4272Y26	\$ 1,928	\$ 2,257	\$ 2,242	
42 x 84	Static	08EL4284Y26	2,145	2,526	2,496	
42 x 90	Static	08EL4290Y26	2,285	2,723	2,663	
42 x 96 *	Static	08EL4296Y26	2,285	2,723	2,676	
48 x 72	Static	08EL4872Y32	2,106	2,481	2,444	
48 x 84	Static	08EL4884Y32	2,502	2,998	2,894	
48 x 90	Static	08EL4890Y32	2,502	2,998	2,906	
48 x 96 *	Static	08EL4896Y32	2,502	2,998	2,918	

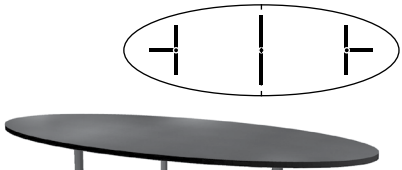
Top Size	Base	Model Number	3P	3K	3W	Elliptical with Y & T-bases
42 x 120	Static	08EL42120Y26T32	\$ 3,313	\$ 4,003	\$ 3,814	
42 x 144	Static	08EL42144Y26T32	3,617	4,429	4,199	
48 x 120	Static	08EL48120Y26T32	3,329	4,027	3,847	
48 x 144	Static	08EL48144Y26T32	3,638	4,459	4,234	



LC SH ← X
N/A quote 3 bases:



* \$200 NET surcharge per order for oversized pallet

For Elite series table options, please reference pages 86-87.

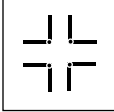

elite X

Square with X-base		Top Size	Base	Model Number	3P	3K	3W
   <p>Flip Top X</p>	24 x 24	Static	08SQ2424X22	\$ 692	\$ 740	\$ 829	
		Flip Top	08SQ2424X22FT	855	903	992	
	30 x 30	Static	08SQ3030X26	864	936	1,036	
		Flip Top	08SQ3030X26FT	935	1,008	1,108	
	36 x 36	Static	08SQ3636X32	880	985	1,094	
		Flip Top	08SQ3636X32FT	1,044	1,149	1,256	
	42 x 42	Static	08SQ4242X36	991	1,132	1,245	
		Flip Top	08SQ4242X36FT	1,233	1,376	1,487	



Square with L-bases		Top Size	Base	Model Number	3P	3K	3W
   <p>4 bases: +200 quote</p>	48 x 48	Static	08SQ4848L26	\$2,232	\$2,415	\$2,526	
		Static	08SQ5454L26	2,350	2,582	2,688	
		Static	08SQ6060L26	2,484	2,768	2,865	

Square with TT-bases		Top Size	Base	Model Number	3P	3K	3W
   <p>nesting TT</p>	48 x 48	Static	08SQ4848TT32	\$1,606	\$1,791	\$1,902	
		Nesting	08SQ4848TT32NE	2,682	2,863	2,971	



For Elite series table options, please reference pages 86-87.

Top Size	Base	Model Number	3P	3K	3W	Round with X-base
24 x 24	Static	08RD24X22	\$ 732	\$ 796	\$ 846	
	Flip Top	08RD24X22FT	895	959	1,008	
30 x 30	Static	08RD30X26	833	933	981	
	Flip Top	08RD30X26FT	998	1,096	1,144	
36 x 36	Static	08RD36X32	958	1,094	1,138	
	Flip Top	08RD36X32FT	1,121	1,256	1,300	
42 x 42	Static	08RD42X32	1,079	1,265	1,296	
	Flip Top	08RD42X32FT	1,322	1,507	1,539	
48 x 48	Static	08RD48X36	1,132	1,331	1,377	



Top Size	Base	Model Number	3P	3K	3W	Round with L-bases
54 x 54	Static	08RD54L26	\$ 2,041	\$ 2,319	\$ 2,329	
60 x 60	Static	08RD60L26	2,068	2,357	2,385	

Top Size	Base	Model Number	3P	3K	3W	Round with TT-base
48 x 48	Static	08RD48TT32	\$ 1,643	\$ 1,841	\$ 1,911	
	Nesting	08RD48TT32NE	2,718	2,913	2,982	
54 x 54	Static	08RD54TT32	1,842	2,120	2,131	
	Nesting	08RD54TT32NE	2,914	3,186	3,197	
60 x 60	Static	08RD60TT32	1,869	2,158	2,187	
	Folding	08RD60TT32FD	2,624	2,914	2,942	
	Nesting	08RD60TT32NE	2,940	3,224	3,251	





For Elite series table options, please reference pages 86-87.

D-shaped with T-bases	Top Size	Base	Model Number	3P	3K	3W
	24 x 36	Static	08D2436T22	\$ 923	\$1,018	\$1,089
		Nesting	08D2436T22NE	1,613	1,705	1,775
	24 x 48	Static	08D2448T22	1,002	1,127	1,207
		Nesting	08D2448T22NE	1,689	1,813	1,889
	24 x 60	Static	08D2460T22	1,080	1,237	1,323
		Nesting	08D2460T22NE	1,767	1,919	2,004
	24 x 72	Static	08D2472T22	1,159	1,346	1,441
		Nesting	08D2472T22NE	1,885	2,069	2,161
 Nesting T	24 x 84	Static	08D2484T22	1,326	1,543	1,646
		Nesting	08D2484T22NE	2,154	2,369	2,469
	24 x 90	Static	08D2490T22	1,363	1,599	1,705
		Nesting	08D2490T22NE	2,193	2,422	2,527
	24 x 96 *	Static	08D2496T22	1,403	1,652	1,762
		Nesting	08D2496T22NE	2,231	2,476	2,585
	30 x 48	Static	08D3048T26	1,092	1,249	1,317
		Nesting	08D3048T26NE	1,778	1,931	1,999
	30 x 60	Static	08D3060T26	1,190	1,385	1,456
		Nesting	08D3060T26NE	1,874	2,066	2,134
	30 x 72	Static	08D3072T26	1,288	1,522	1,594
		Nesting	08D3072T26NE	2,012	2,242	2,313
	30 x 84	Static	08D3084T26	1,474	1,748	1,821
		Nesting	08D3084T26NE	2,301	2,569	2,641
	30 x 90	Static	08D3090T26	1,522	1,816	1,890
	30 x 96 *	Static	08D3096T26	1,572	1,884	1,960
	36 x 48	Static	08D3648T26	1,171	1,358	1,416
		Nesting	08D3648T26NE	1,855	2,039	2,094
	36 x 60	Static	08D3660T26	1,288	1,522	1,575
		Nesting	08D3660T26NE	2,060	2,289	2,342
	36 x 72	Static	08D3672T26	1,405	1,687	1,735
		Nesting	08D3672T26NE	2,292	2,569	2,616
	36 x 84	Static	08D3684T26	1,610	1,939	1,984
	36 x 90	Static	08D3690T26	1,669	2,021	2,064
36 x 96 *	Static	08D3696T26	1,729	2,104	2,145	

* \$200 NET surcharge per order for oversized pallet

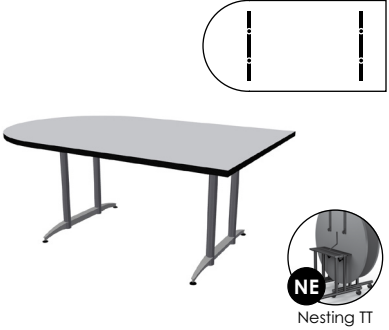
For Elite series table options, please reference pages 86-87.

Top Size	Base	Model Number	3P	3K	3W	D-shaped with TT-bases
42 x 60	Static	08D4260TT32	\$ 2,197	\$ 2,617	\$ 2,544	
	Nesting	08D4260TT32NE	3,262	3,674	3,602	
42 x 72	Static	08D4272TT32	2,197	2,617	2,574	
	Nesting	08D4272TT32NE	3,262	3,674	3,631	
48 x 60	Static	08D4860TT32	2,241	2,679	2,604	
	Nesting	08D4860TT32NE	3,305	3,734	3,660	
48 x 72	Static	08D4872TT32	2,241	2,679	2,635	
	Nesting	08D4872TT32NE	3,305	3,734	3,691	

Top Size	Base	Model Number	3P	3K	3W	D-shaped with Y & T-bases
42 x 60	Static	08D4260Y32T32	\$ 2,061	\$ 2,481	\$ 2,407	
42 x 72	Static	08D4272Y32T32	2,061	2,481	2,438	
42 x 84	Static	08D4284Y32T32	2,181	2,615	2,593	
42 x 90	Static	08D4290Y32T32	2,260	2,724	2,695	
42 x 96 *	Static	08D4296Y32T32	2,337	2,832	2,795	
48 x 60	Static	08D4860Y36T36	2,159	2,597	2,523	
48 x 72	Static	08D4872Y36T36	2,159	2,597	2,553	
48 x 84	Static	08D4884Y36T36	2,247	2,685	2,673	
48 x 90	Static	08D4890Y36T36	2,326	2,795	2,774	
48 x 96 *	Static	08D4896Y36T36	2,404	2,904	2,875	

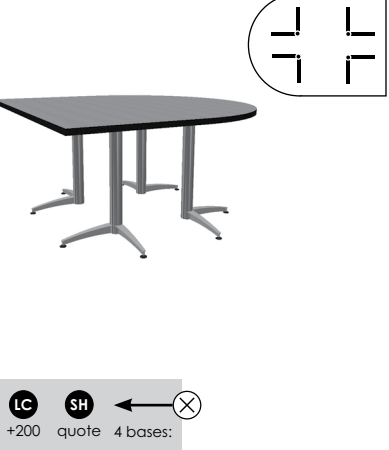
Top Size	Base	Model Number	3P	3K	3W	D-shaped with L-bases
54 x 54	Static	08D5454L26	\$ 2,740	\$ 3,125	\$ 3,085	
54 x 60	Static	08D5460L26	2,797	3,207	3,165	
54 x 72	Static	08D5472L26	2,827	3,248	3,228	
54 x 84	Static	08D5484L26	3,120	3,624	3,573	
54 x 90	Static	08D5490L26	3,120	3,624	3,588	
54 x 96 *	Static	08D5496L26	3,120	3,624	3,604	
60 x 60	Static	08D6060L26	2,748	3,140	3,124	
60 x 72	Static	08D6072L26	2,905	3,358	3,327	
60 x 84	Static	08D6084L26	3,208	3,746	3,682	
60 x 90	Static	08D6090L26	3,208	3,746	3,698	
60 x 96 *	Static	08D6096L26	3,208	3,746	3,713	

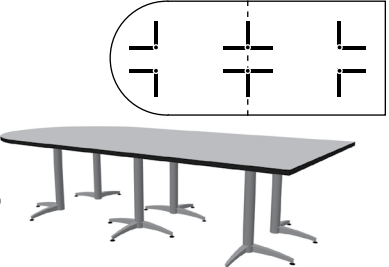

LC SH ← ⊗
+200 quote 4 bases:



Top Size	Base	Model Number	3P	3K	3W	D-shaped with L & Y-bases
54 x 120	Static	08D54120L26Y26	\$ 4,981	\$ 5,814	\$ 5,611	
54 x 144	Static	08D54144L26Y26	5,187	6,102	5,898	
60 x 120	Static	08D60120L26Y26	5,016	5,863	5,660	
60 x 144	Static	08D60144L26Y26	5,226	6,158	5,954	

LC SH ← ⊗
N/A N/A 3 bases:

* \$200 NET surcharge per order for oversized pallet

For Elite series table options, please reference pages 86-87.

Half Round with T-bases	Top Size	Base	Model Number	3P	3K	3W
 	24 x 48	Static	08HR2448T18	\$ 1,005	\$ 1,132	\$ 1,197
		Nesting	08HR2448T18NE	1,693	1,817	1,881
	30 x 60	Static	08HR3060T22	1,180	1,376	1,428
		Nesting	08HR3060T22NE	1,863	2,056	2,108
	36 x 72	Static	08HR3672T26	1,403	1,685	1,714
		Nesting	08HR3672T26NE	2,216	2,491	2,520

Trapezoid with T-bases	Top Size	Base	Model Number	3P	3K	3W
 	24 x 48	Static	08TZ2448T18	\$ 996	\$ 1,118	\$ 1,186
	24 x 72	Static	08TZ2472T18	1,194	1,396	1,484
		Nesting	08TZ2472T18NE	1,878	2,075	2,161
	30 x 60	Static	08TZ3060T22	1,128	1,304	1,372
		Nesting	08TZ3060T22NE	1,813	1,984	2,051
	36 x 72	Static	08TZ3672T26	1,376	1,646	1,684
Nesting		08TZ3672T26NE	2,189	2,453	2,489	

Squircle with X-base	Top Size	Base	Model Number	3P	3K	3W
	24 x 24	Static	08SL24X22	\$ 914	\$ 1,049	\$ 1,071
		Flip Top	08SL24X22FT	1,077	1,212	1,234
	30 x 30	Static	08SL30X26	986	1,146	1,183
		Flip Top	08SL30X26FT	1,150	1,311	1,346
	36 x 36	Static	08SL36X32	1,084	1,270	1,317
		Flip Top	08SL36X32FT	1,247	1,433	1,481
42 x 42	Static	08SL42X36	1,174	1,389	1,446	
	Flip Top	08SL42X36FT	1,418	1,632	1,689	

For Elite series table options, please reference pages 86-87.

For Elite series table options, please reference pages 86-87.

table 

09 revel
price list
Effective January 1, 2023





The elegant look and design of our Revel series injects a bit of refinement into a workspace or classroom. Two-tone for a distinctive look. With Revel, you can create additional interest and tie in your brand by selecting a different powder coat finish for the column and main bar. 32 standard finishes available!

Revel Base Style

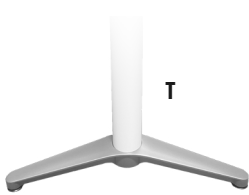

Revel Edge Options

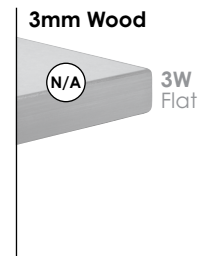
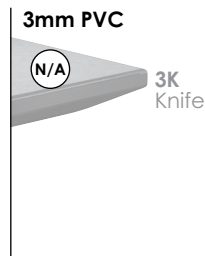
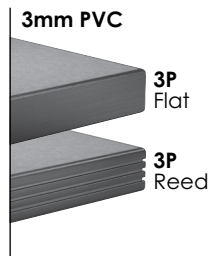

Revel Top Options

QG Quick-Connect Ganging Brackets can be added to any table for \$45 (includes 4 connectors per table).

RC 3" Radius Corners can be added to any table for \$61.

GR Grommets can be added to any table for \$45 each. To see specific locations, see page 227.

Revel Options

Standard
Plastic
Glides



Locking
Casters





LC **Locking Casters**
can be added to any
table for \$111 per set
of four.

NE **Nesting Tables**
priced accordingly with
locking casters.

WM **Wire Management**
Built-in wire management
is not available on
Revel tables.

**WM
LC** **3" Wire Management
Leg Covers**
snap onto any leg and
are \$79 each.

SH **Special Height**
can be added
to any table:
+ \$72 per column
for heights > 29"
+ \$39 per column
for heights < 29"
Special height tables with
tops larger than 36x72"
must be custom quoted.

Top Size	Base	Model Number	3P	Rectangular Top with Revel Base
24 x 60	Static	09TC2460T22	\$ 927	 
	Nesting	09TC2460T22NE	1,610	
24 x 72	Static	09TC2472T22	977	
	Nesting	09TC2472T22NE	1,886	
30 x 60	Static	09TC3060T22	979	
	Nesting	09TC3060T22NE	1,662	
30 x 72	Static	09TC3072T22	1,035	
	Nesting	09TC3072T22NE	1,944	

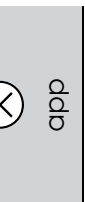

table



17 app

price list

Effective January 1, 2023

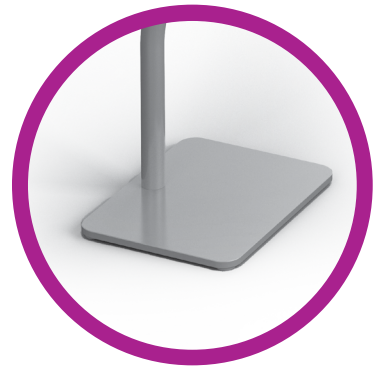

App Styles

Grab your laptop or tablet and pull up the App table. These small, lightweight tables are perfect for casual areas in the workplace or school.

20-lb weight limit.



App Base Styles



App .75" Edge Options

(corresponds with 2 columns of pricing)

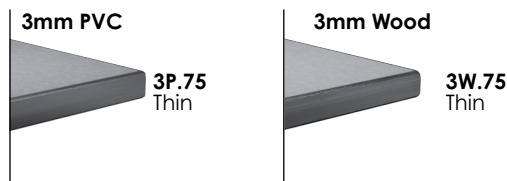

App Top Shapes



Height Adjustability

We offer the ultimate in work mobility with our App height adjustable table. The cutaway, crescent-shaped base allows you to pull up close to any seating option, and the smooth, lever-less height adjustment will make the use of your personal device truly comfortable.



CUP Slide-Out Cup Holder can be added for \$63

Top Size	Base	Model Number	3P.75	3W.75	Soft Rectangle with Rectangular Base
12 x 18	Static	17RC1218QD912-B	\$ 512	\$ 607	

Overall height: 26"



Top Size	Base	Model Number	3P.75	3W.75	Soft Rectangle with Rectangle Base
12 x 18	Static	17RC1218QD912-S	512	607	

Overall height: 26"



Top Size	Base	Model Number	3P.75	3W.75	Round with Disc Base
18 x 18	Static	17RD18D12	473	561	

Overall height: 26"



Top Size	Base	Model Number	3P.75	3W.75	Soft Rectangle with Crescent Base
12 x 18	Adj.	17RC1218C-AH	819	910	

Overall height range: 20.75-30.75"



Top Size	Base	Model Number	3P.75	3W.75	Round with Crescent Base
18 x 18	Adj.	17RD18C-AH	780	868	

Overall height range: 20.75-30.75"



table 

33 element
price list
Effective January 1, 2023





Low profile and lightweight aluminum construction makes Element a great mobile solution. Pair it up with your choice of nine different top shapes to create table configurations that are easy to handle.

Element Base Styles



Element Options

<p>Standard Plastic Glides</p> 	<p>LC Locking Casters can be added to any table for \$111 per set of four.</p>	<p>OS Offset T-bases available for \$39 per table. Offset is not available on 18" d tables or 30" d nesting tables less than 60" wide.</p>	<p>SH Special Height can be added to any X-based table: + \$72 per column for heights > 29" - heights < 29" are not available Special heights are not available on T or TT-bases.</p>
<p>Locking Casters</p> 	<p>CCG Concealed Casters available on one T-base for \$137 per table. Standard glides on opposite base.</p>	<p>CH Chrome Finish is not available on Element tables.</p>	<p>FR Footring is not available on Element series.</p>
<p>Concealed Casters</p> 	<p>FD Folding Bases priced accordingly with standard glides.</p> <p>NE Nesting Tables priced accordingly with locking casters.</p> <p>FT Flip Tops available on X-based tables and are priced with standard glides.</p>	<p>WM Wire Management Built-in wire management is not available on Element tables.</p> <p>WM/LC Wire Management Leg Covers Call customer service for available options.</p>	<p>PB Powerbox Mounting Plate is not available on Element tables.</p>

Element Height Adjustable Options

Height adjustability only available on Element Solo products. See page 122.

Element Top Shapes



Rectangle
p.114



Racetrack
p.116

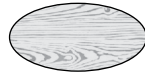

Elliptical
p.116



D-shaped
p.117



Square
p.118



Round
p.119



Half Round
p.116



Trapezoid
p.120



Squircle
p.120

Element Top Options

QC Quick-Connect Ganging Brackets can be added to any table for \$45 (includes 4 connectors per table).





RC 3" Radius Corners can be added to any table for \$61.

GR Grommets can be added to any table for \$45 each. To see specific locations, see page 227.

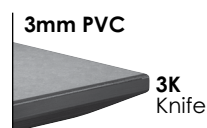
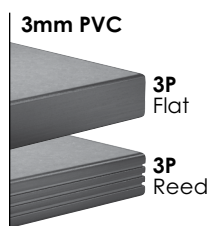



Element Edge Options



(corresponds with 3 columns of pricing)





Rectangular with T-bases	Top Size	Base	Model Number	3P	3K	3W
   	18 x 36	Static	33TC1836T16	\$ 672	\$ 726	\$ 826
		Nesting	33TC1836T18NE	1,365	1,419	1,516
	18 x 48	Static	33TC1848T16	717	787	905
		Folding	33TC1848T16FD	1,044	1,116	1,233
		Nesting	33TC1848T18NE	1,409	1,478	1,594
	18 x 60	Static	33TC1860T16	760	849	984
		Folding	33TC1860T16FD	1,101	1,190	1,327
		Nesting	33TC1860T18NE	1,452	1,539	1,671
	18 x 72	Static	33TC1872T16	804	910	1,063
		Folding	33TC1872T16FD	1,145	1,251	1,404
		Nesting	33TC1872T18NE	1,730	1,834	1,984
	20 x 36	Static	33TC2036T18	714	786	877
		Nesting	33TC2036T18NE	1,407	1,477	1,568
	20 x 48	Static	33TC2048T18	771	867	973
		Folding	33TC2048T18FD	1,100	1,194	1,299
		Nesting	33TC2048T18NE	1,464	1,556	1,659
	20 x 60	Static	33TC2060T18	800	902	1,032
		Folding	33TC2060T18FD	1,140	1,245	1,374
		Nesting	33TC2060T18NE	1,489	1,592	1,718
	20 x 72	Static	33TC2072T18	849	973	1,118
		Folding	33TC2072T18FD	1,189	1,314	1,460
		Nesting	33TC2072T18NE	1,774	1,895	2,037
	24 x 36	Static	33TC2436T22	714	786	889
		Nesting	33TC2436T22NE	1,407	1,477	1,578
24 x 48	Static	33TC2448T22	771	867	982	
	Folding	33TC2448T22FD	1,100	1,194	1,311	
	Nesting	33TC2448T22NE	1,464	1,556	1,670	
24 x 60	Static	33TC2460T22	800	902	1,043	
	Folding	33TC2460T22FD	1,140	1,245	1,384	
	Nesting	33TC2460T22NE	1,489	1,592	1,729	
24 x 72	Static	33TC2472T22	849	973	1,128	
	Folding	33TC2472T22FD	1,189	1,314	1,469	
	Nesting	33TC2472T22NE	1,774	1,895	2,048	
30 x 36	Static	33TC3036T26	761	849	955	
	Nesting	33TC3036T26NE	1,453	1,539	1,643	
30 x 48	Static	33TC3048T26	832	948	1,064	
	Folding	33TC3048T26FD	1,161	1,276	1,392	
	Nesting	33TC3048T26NE	1,522	1,637	1,750	
30 x 60	Static	33TC3060T26	854	980	1,119	
	Folding	33TC3060T26FD	1,196	1,320	1,461	
	Nesting	33TC3060T26NE	1,544	1,667	1,803	

For Element series table options, please reference pages 112-113.



Top Size	Base	Model Number	3P	3K	3W	Rectangular with T-bases
30 x 72	Static	33TC3072T26	\$ 910	\$ 1,057	\$ 1,211	   FD Folding T  NE Nesting T
	Folding	33TC3072T26FD	1,251	1,399	1,552	
	Nesting	33TC3072T26NE	1,834	1,979	2,129	
36 x 48	Static	33TC3648T26	889	1,027	1,141	
	Folding	33TC3648T26FD	1,217	1,355	1,468	
	Nesting	33TC3648T26NE	1,710	1,846	1,958	
36 x 60	Static	33TC3660T26	974	1,145	1,266	
	Folding	33TC3660T26FD	1,315	1,487	1,606	
	Nesting	33TC3660T26NE	1,868	2,039	2,155	
36 x 72	Static	33TC3672T26	1,026	1,221	1,355	
	Folding	33TC3672T26FD	1,368	1,562	1,696	
	Nesting	33TC3672T26NE	1,948	2,138	2,270	



Top Size	Base	Model Number	3P	3K	3W	Rectangular with TT-bases
42 x 60	Static	33TC4260TT30	\$ 1,376	\$ 1,579	\$ 1,691	 
42 x 72	Static	33TC4272TT30	1,477	1,719	1,834	
48 x 60	Static	33TC4860TT36	1,455	1,668	1,789	
48 x 72	Static	33TC4872TT36	1,615	1,893	1,995	

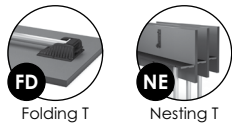

For Element series table options, please reference pages 112-113.

Race-track with T-bases	Top Size	Base	Model Number	3P	3K	3W
 	36 x 60	Static	33RT3660T26	\$ 1,246	\$ 1,528	\$ 1,526
		Nesting	33RT3660T26NE	2,062	2,337	2,335
	36 x 72	Static	33RT3672T26	1,246	1,528	1,557
		Folding	33RT3672T26FD	1,587	1,869	1,899
		Nesting	33RT3672T26NE	2,136	2,413	2,441



Elliptical with T-bases	Top Size	Base	Model Number	3P	3K	3W
 	30 x 54	Static	33EL3054T22	\$ 982	\$ 1,161	\$ 1,199
	30 x 60	Static	33EL3060T22	1,029	1,227	1,263
	36 x 60	Static	33EL3660T26	1,133	1,370	1,388
	36 x 72	Static	33EL3672T26	1,246	1,528	1,537



Top Size	Base	Model Number	3P	3K	3W	D-shaped with T-bases
24 x 36	Static	33D2436T22	\$ 771	\$ 866	\$ 937	   Nesting T
	Nesting	33D2436T22NE	1,464	1,556	1,626	
24 x 48	Static	33D2448T22	850	975	1,055	
	Nesting	33D2448T22NE	1,540	1,663	1,740	
24 x 60	Static	33D2460T22	929	1,085	1,172	
	Nesting	33D2460T22NE	1,617	1,771	1,856	
24 x 72	Static	33D2472T22	1,006	1,194	1,289	
	Nesting	33D2472T22NE	1,735	1,919	2,013	
30 x 48	Static	33D3048T26	932	1,088	1,157	
	Nesting	33D3048T26NE	1,621	1,774	1,841	
30 x 60	Static	33D3060T26	1,029	1,225	1,295	
	Nesting	33D3060T26NE	1,716	1,908	1,977	
30 x 72	Static	33D3072T26	1,128	1,361	1,433	
	Nesting	33D3072T26NE	1,855	2,085	2,155	
36 x 48	Static	33D3648T26	1,010	1,197	1,254	
	Nesting	33D3648T26NE	1,696	1,881	1,937	
36 x 60	Static	33D3660T26	1,128	1,361	1,415	
	Nesting	33D3660T26NE	1,902	2,132	2,183	
36 x 72	Static	33D3672T26	1,245	1,526	1,574	
	Nesting	33D3672T26NE	2,134	2,411	2,459	

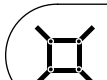

Top Size	Base	Model Number	3P	3K	3W	D-shaped with TT-bases
42 x 60	Static	33D4260TT30	\$ 1,921	\$ 2,341	\$ 2,266	 
42 x 72	Static	33D4272TT30	1,921	2,341	2,298	
48 x 60	Static	33D4860TT36	2,016	2,453	2,378	
48 x 72	Static	33D4872TT36	2,016	2,453	2,410	



Top Size	Base	Model Number	3P	3K	3W	D-shaped with 4-column X-base
54 x 54	Static	33D5454X36.4	\$ 2,364	\$ 2,749	\$ 2,709	 
60 x 60	Static	33D6060X42.4	2,413	2,804	2,789	

SH +286 X.4:

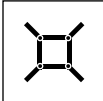

For Element series table options, please reference pages 112-113.

Square with X-base		Top Size	Base	Model Number	3P	3K	3W
   <p>Flip Top X</p>	24 x 24	Static	33SQ2424X22	\$ 713	\$ 761	\$ 849	
		Flip Top	33SQ2424X22FT	876	923	1,013	
	30 x 30	Static	33SQ3030X26	793	868	966	
		Flip Top	33SQ3030X26FT	957	1,031	1,131	
	36 x 36	Static	33SQ3636X32	888	992	1,100	
		Flip Top	33SQ3636X32FT	1,050	1,155	1,264	
	42 x 42	Static	33SQ4242X36	1,013	1,154	1,266	
		Flip Top	33SQ4242X36FT	1,255	1,397	1,508	



Square with 4-column X-base		Top Size	Base	Model Number	3P	3K	3W
 	48 x 48	Static	33SQ4848X36.4	\$ 1,856	\$ 2,040	\$ 2,150	
	54 x 54	Static	33SQ5454X36.4	1,974	2,205	2,313	
	60 x 60	Static	33SQ6060X42.4	2,148	2,433	2,530	







 X.4: +286

Square with TT-bases		Top Size	Base	Model Number	3P	3K	3W
 	48 x 48	Static	33SQ4848TT26	\$ 1,330	\$ 1,514	\$ 1,624	

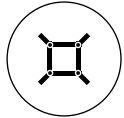
For Element series table options, please reference pages 112-113.

Top Size	Base	Model Number	3P	3K	3W	Round with X-base
24 x 24	Static	33RD24X22	\$ 753	\$ 816	\$ 867	 
	Flip Top	33RD24X22FT	916	980	1,029	
30 x 30	Static	33RD30X26	856	955	1,003	
	Flip Top	33RD30X26FT	1,020	1,118	1,166	
36 x 36	Static	33RD36X32	964	1,100	1,144	
	Flip Top	33RD36X32FT	1,128	1,264	1,309	
42 x 42	Static	33RD42X32	1,087	1,271	1,304	
	Flip Top	33RD42X32FT	1,330	1,514	1,547	
48 x 48	Static	33RD48X36	1,154	1,353	1,399	



Top Size	Base	Model Number	3P	3K	3W	Round with 4-column X-base
54 x 54	Static	33RD54X36.4	\$2,091	\$2,369	\$2,380	 
60 x 60	Static	33RD60X36.4	2,119	2,408	2,435	

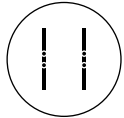

 +286 ← 

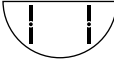

Top Size	Base	Model Number	3P	3K	3W	Round with TT-base
48 x 48	Static	33RD48TT26	\$1,365	\$1,563	\$1,610	 
54 x 54	Static	33RD54TT30	1,564	1,843	1,855	
60 x 60	Static	33RD60TT30	1,593	1,882	1,909	
	Folding	33RD60TT30FD	2,348	2,637	2,664	



For Element series table options, please reference pages 112-113.

Half Round with T-bases	Top Size	Base	Model Number	3P	3K	3W
   <p>Nesting T</p>	18 x 36	Static	33HR1836T16	\$ 783	\$ 880	\$ 927
	24 x 48	Static	33HR2448T16	853	980	1,045
		Nesting	33HR2448T16NE	1,543	1,668	1,732
	30 x 60	Static	33HR3060T22	1,027	1,224	1,276
		Nesting	33HR3060T22NE	1,714	1,906	1,958
	36 x 72	Static	33HR3672T26	1,244	1,524	1,553
Nesting		33HR3672T26NE	2,058	2,333	2,362	

Trapezoid with T-bases	Top Size	Base	Model Number	3P	3K	3W
   <p>Nesting T</p>	24 x 48	Static	33TZ2448T18	\$ 844	\$ 965	\$ 1,034
	24 x 72	Static	33TZ2472T18	1,042	1,244	1,332
		Nesting	33TZ2472T18NE	1,728	1,926	2,013
	30 x 60	Static	33TZ3060T22	976	1,151	1,220
		Nesting	33TZ3060T22NE	1,664	1,836	1,903
	36 x 72	Static	33TZ3672T26	1,215	1,485	1,522
Nesting		33TZ3672T26NE	2,031	2,296	2,331	

Squircle with X-base	Top Size	Base	Model Number	3P	3K	3W
 	24 x 24	Static	33SL24X22	\$ 934	\$ 1,070	\$ 1,092
		Flip Top	33SL24X22FT	1,097	1,233	1,255
	30 x 30	Static	33SL30X26	1,008	1,169	1,205
		Flip Top	33SL30X26FT	1,172	1,333	1,368
	36 x 36	Static	33SL36X32	1,091	1,276	1,323
		Flip Top	33SL36X32FT	1,254	1,440	1,487
42 x 42	Static	33SL42X36	1,196	1,411	1,467	
	Flip Top	33SL42X36FT	1,439	1,653	1,710	

For Element series table options, please reference pages 112-113.

Solo Tables: Static, Counterbalanced, and/or Flip Top

Element Solo tables are designed with a single user in mind. Perfect for the classroom, these tables come in a variety of configurations that make them incredibly versatile.

Standard Models:



Static

The standard model is a simple, 29" high table with levelers. Specify with locking casters and the overall height remains 29".



Flip Top

A standard 29" high table with a flip top mechanism for easier storage. Specify with locking casters and the overall height remains 29".

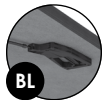

Counterbalanced

A height adjustable column takes this top from 26.75-44.25". Specify with locking casters and the height range increases by 2".



Counterbalanced + Flip Top

A height adjustable column takes this top from 26.75-44.25". Includes a flip top mechanism for easier storage. Specify with locking casters and the height range increases by 1.5".

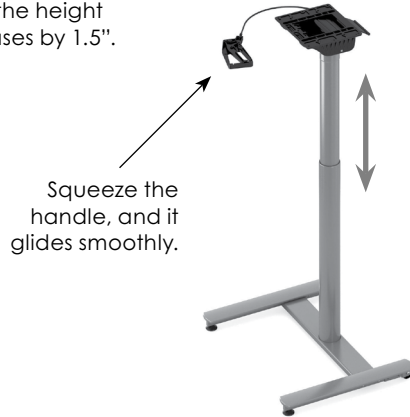

Solo Options

CCG Concealed Caster (non locking) / Glide Combo creates a wheelbarrow effect. Available on Element Solo H-bases for \$137 list.

LC1.5 1.5" Low Profile Locking Casters can be added to any table for \$111 per set of four

MARKER Markerboard Top can be added for \$111 per table (see page 16 for details)

CUP Slide-Out Cup Holder can be added for \$63

FT-GT Flip top w/ 15° tilt lock option add \$33 to the FT Flip Top price

PS Acrylic Pencil Stop for tilt lock option can be added for \$32

Element Solo Top Shapes



Rectangle p.124



Trapezoid p.124

Element Solo Base Styles



H

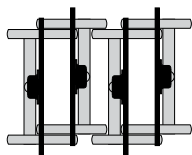



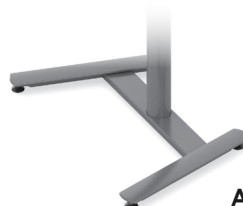

H-base features face-to-face offset nesting

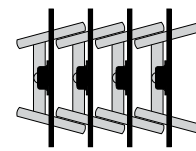









A



A-base features in-line nesting

Top Size	Base	Model Number	3P	3K	3W	Solo Rectangle with H-base
20 x 30	Static	33TC2030H1830	\$ 782	\$ 842	\$ 926	   
	Flip Top	33TC2030H1830FT	1,023	1,083	1,167	
	Count Bal	33TC2030H1830BL	1,432	1,491	1,577	
	Bal + Flip	33TC2030H1830BLFT	1,566	1,626	1,711	
20 x 36	Static	33TC2036H1830	810	881	974	
	Flip Top	33TC2036H1830FT	1,052	1,122	1,215	
	Count Bal	33TC2036H1830BL	1,461	1,531	1,624	
	Bal + Flip	33TC2036H1830BLFT	1,595	1,667	1,758	
24 x 30	Static	33TC2430H1830	782	842	937	
	Flip Top	33TC2430H1830FT	1,023	1,083	1,178	
	Count Bal	33TC2430H1830BL	1,432	1,491	1,586	
	Bal + Flip	33TC2430H1830BLFT	1,566	1,626	1,722	
24 x 36	Static	33TC2436H1830	810	881	984	
	Flip Top	33TC2436H1830FT	1,052	1,122	1,225	
	Count Bal	33TC2436H1830BL	1,461	1,531	1,634	
	Bal + Flip	33TC2436H1830BLFT	1,595	1,667	1,769	

Top Size	Base	Model Number	3P	3K	3W	Solo Rectangle with A-base
20 x 30	Static	33TC2030A1830	\$ 782	\$ 842	\$ 926	   
	Flip Top	33TC2030A1830FT	1,023	1,083	1,167	
	Count Bal	33TC2030A1830BL	1,432	1,491	1,577	
	Bal + Flip	33TC2030A1830BLFT	1,566	1,626	1,711	
24 x 30	Static	33TC2430A1830	782	842	937	
	Flip Top	33TC2430A1830FT	1,023	1,083	1,178	
	Count Bal	33TC2430A1830BL	1,432	1,491	1,586	
	Bal + Flip	33TC2430A1830BLFT	1,566	1,626	1,722	

Top Size	Base	Model Number	3P	3K	3W	Solo Trapezoid with A-base
24 x 36	Static	33TZ2436A1830	\$ 939	\$1,062	\$1,125	   
	Flip Top	33TZ2436A1830FT	1,181	1,301	1,365	
	Count Bal	33TZ2436A1830BL	1,588	1,711	1,775	
	Bal + Flip	33TZ2436A1830BLFT	1,725	1,846	1,909	

table~~x~~

40 justice
price list
Effective January 1, 2023



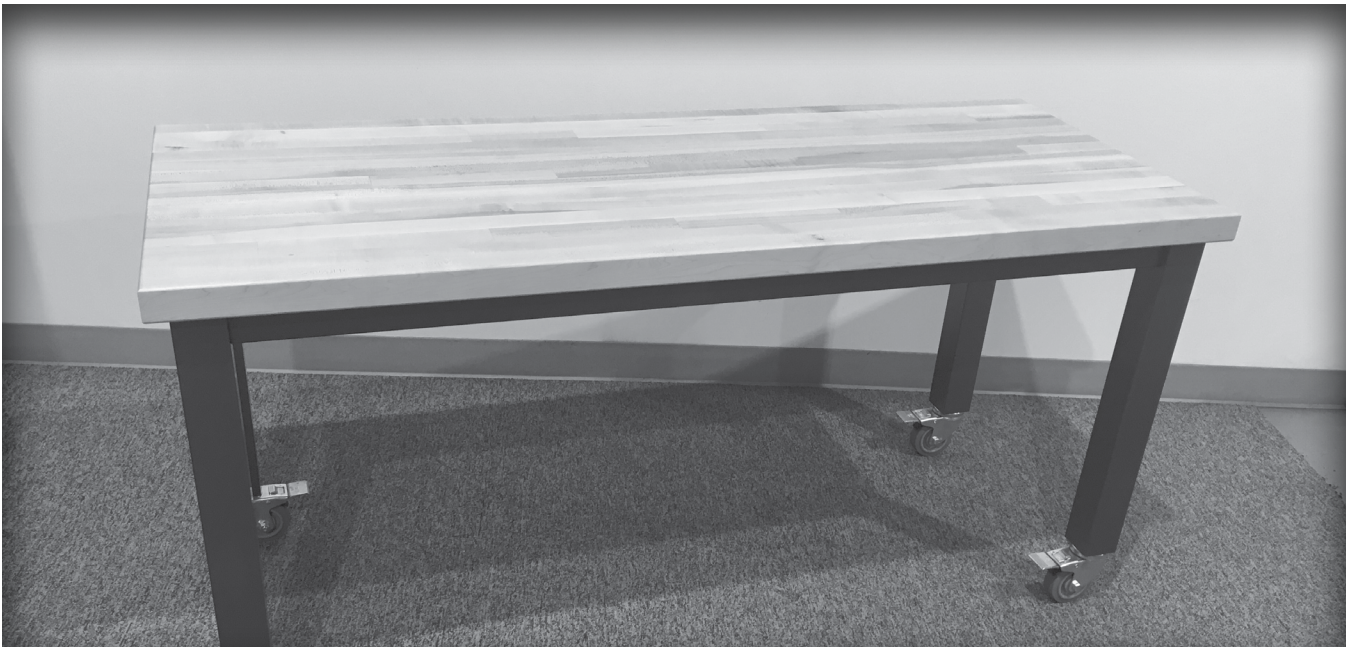

A rigid apron frame and square column legs make Justice a heavy-duty choice when long-lasting durability is a requirement. Its unique design gives it the stability to handle a 500 lb. weight capacity. Justice is available in three different heights and offers mobility when specified with industrial locking casters.

Justice Rigid Frame with Square Column Legs

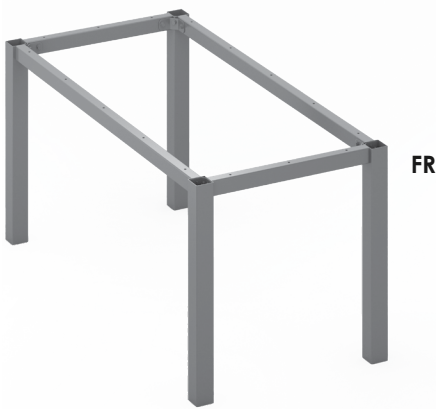

FR

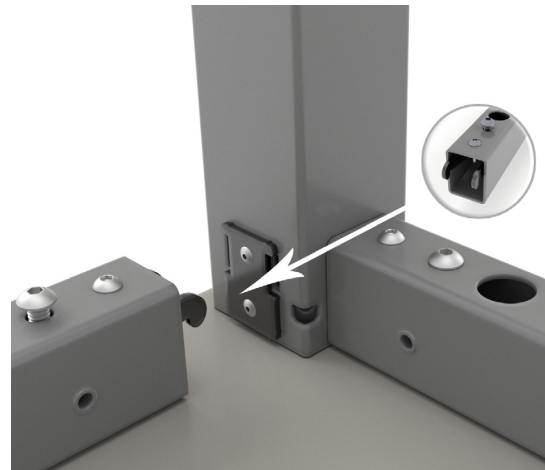

Justice Options

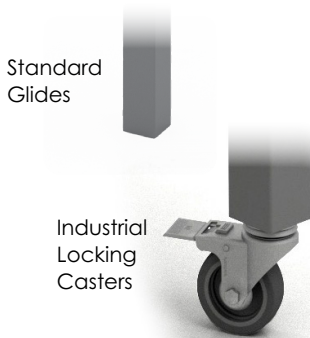

Standard Glides

Industrial Locking Casters

ILC **Industrial Locking Casters** can be added to any Justice table for \$332 per set of four.

FD **Folding Bases** are not available on Justice tables.

NE **Nesting Tables** are not available in the Justice series.

FT **Flip Tops** are not available on Justice tables.

WM **Wire Management** Built-in wire management is not available on Justice tables.

WM/LC **Magnetic Wire Management Leg Covers** Magnetically attaches onto any square leg and are \$71 each.

CH **Chrome Finish** is not available on Justice tables.

SH **Special Heights** of 36" or 42" are available on Justice tables for \$121 per table. Other custom heights are not available on Justice.

Justice Top Shapes

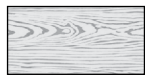

Rectangle
p.128



Square
p.129



Round
p.129



Squircle
p.129



Boat
p.130

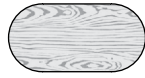

Racetrack
p.130



Elliptical
p.130



D-shaped
p.131

Justice Top Options

GR Grommets
can be added to any table for \$45 each. To see specific locations, See page 227. Locations may be adjusted to avoid Justice frame.

BB Maple Butcher Block
is 1.75" thick with a food-grade clearcoat finish. Available in specific sizes with no grommets and clamp-on power only. Clamp-on power information can be found on page 219.

Call for pricing.

Justice Edge Options

(corresponds with 3 columns of pricing)

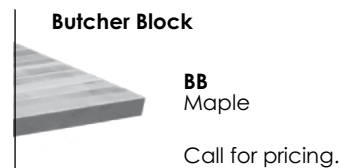
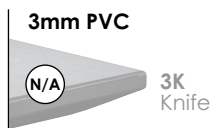
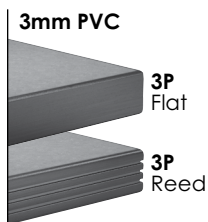

Rectangular with Frame & Columns





Top Size	Base	Model Number	3P	3K	3W
24 x 36	Static	40TC2436FR2234	1,203	NA	1,376
24 x 48	Static	40TC2448FR2246	1,289	NA	1,499
24 x 60	Static	40TC2460FR2258	1,321	NA	1,565
24 x 72	Static	40TC2472FR2270	1,403	NA	1,684
24 x 84	Static	40TC2484FR2270	1,499	NA	1,820
24 x 90	Static	40TC2490FR2270	1,557	NA	1,899
24 x 96 *	Static	40TC2496FR2270	1,557	NA	1,914
30 x 36	Static	40TC3036FR2834	1,252	NA	1,445
30 x 48	Static	40TC3048FR2846	1,342	NA	1,574
30 x 60	Static	40TC3060FR2858	1,386	NA	1,651
30 x 72	Static	40TC3072FR2870	1,474	NA	1,775
30 x 84	Static	40TC3084FR2870	1,609	NA	1,956
30 x 90	Static	40TC3090FR2870	1,682	NA	2,049
30 x 96 *	Static	40TC3096FR2870	1,682	NA	2,065
36 x 48	Static	40TC3648FR3446	1,409	NA	1,662
36 x 60	Static	40TC3660FR3458	1,522	NA	1,815
36 x 72	Static	40TC3672FR3470	1,604	NA	1,932
36 x 84	Static	40TC3684FR3470	1,720	NA	2,091
36 x 90	Static	40TC3690FR3470	1,804	NA	2,199
36 x 96 *	Static	40TC3696FR3470	1,804	NA	2,215
42 x 60	Static	40TC4260FR4058	1,587	NA	1,903
42 x 72	Static	40TC4272FR4070	1,709	NA	2,065
42 x 84	Static	40TC4284FR4070	1,805	NA	2,202
42 x 90	Static	40TC4290FR4070	1,900	NA	2,322
42 x 96 *	Static	40TC4296FR4070	1,900	NA	2,337
48 x 60	Static	40TC4860FR4658	1,641	NA	1,973
48 x 72	Static	40TC4872FR4670	1,829	NA	2,210
48 x 84	Static	40TC4884FR4670	1,839	NA	2,252
48 x 90	Static	40TC4890FR4670	1,935	NA	2,371
48 x 96 *	Static	40TC4896FR4670	1,935	NA	2,387

* \$200 NET surcharge per order for oversized pallet

For all Justice series table options, please reference pages 126-127.

Top Size	Base	Model Number	3P	3K	3W	Square with Frame & Columns
24 x 24	Static	40SQ2424FR2222	\$ 1,125	NA	\$ 1,263	 
30 x 30	Static	40SQ3030FR2828	1,207	NA	1,380	
36 x 36	Static	40SQ3636FR3434	1,308	NA	1,520	
42 x 42	Static	40SQ4242FR4040	1,424	NA	1,678	
48 x 48	Static	40SQ4848FR4646	1,541	NA	1,837	
54 x 54	Static	40SQ5454FR4646	1,662	NA	1,999	
60 x 60	Static	40SQ6060FR4646	1,794	NA	2,176	

Top Size	Base	Model Number	3P	3K	3W	Round with Frame & Columns
36 x 36	Static	40RD36FR2222	\$ 1,344	NA	\$ 1,526	 
42 x 42	Static	40RD42FR2828	1,484	NA	1,701	
48 x 48	Static	40RD48FR2828	1,518	NA	1,762	
54 x 54	Static	40RD54FR3434	1,740	NA	2,029	
60 x 60	Static	40RD60FR4040	1,793	NA	2,109	

Top Size	Base	Model Number	3P	3K	3W	Squircle with Frame & Columns
30 x 30	Static	40SL30FR2222	\$ 1,405	NA	\$ 1,568	 
36 x 36	Static	40SL36FR2222	1,472	NA	1,665	
42 x 42	Static	40SL42FR2828	1,560	NA	1,784	
48 x 48	Static	40SL48FR3434	1,669	NA	1,927	

For all Justice series table options, please reference pages 126-127.

Boat-shaped with Frame & Columns

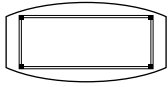

Top Size	Base	Model Number	3P	3K	3W
30 x 42 x 84	Static	40BT3084FR2870	\$2,061	NA	\$2,435
30 x 42 x 90	Static	40BT3090FR2870	2,196	NA	2,600
30 x 42 x 96 *	Static	40BT3096FR2870	2,196	NA	2,616
36 x 48 x 84	Static	40BT3684FR3470	2,209	NA	2,606
36 x 48 x 90	Static	40BT3690FR3470	2,363	NA	2,790
36 x 48 x 96 *	Static	40BT3696FR3470	2,363	NA	2,806

Racetrack with Frame & Columns

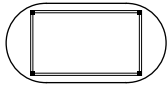

Top Size	Base	Model Number	3P	3K	3W
36 x 72	Static	40RT3672FR2846	\$ 1,757	NA	\$2,068
36 x 84	Static	40RT3684FR2858	2,026	NA	2,392
36 x 90	Static	40RT3690FR2858	2,165	NA	2,560
36 x 96 *	Static	40RT3696FR2870	2,196	NA	2,608
42 x 84	Static	40RT4284FR3458	2,043	NA	2,418
42 x 90	Static	40RT4290FR3458	2,180	NA	2,586
42 x 96 *	Static	40RT4296FR3470	2,210	NA	2,630
48 x 84	Static	40RT4884FR4058	2,325	NA	2,739
48 x 90	Static	40RT4890FR4058	2,325	NA	2,754
48 x 96 *	Static	40RT4896FR4070	2,345	NA	2,789

Elliptical with Frame & Columns

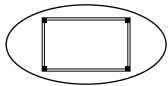

Top Size	Base	Model Number	3P	3K	3W
36 x 72	Static	40EL3672FR2234	\$ 1,731	NA	\$2,021
36 x 84	Static	40EL3684FR2246	1,878	NA	2,203
36 x 90	Static	40EL3690FR2246	1,991	NA	2,341
36 x 96 *	Static	40EL3696FR2258	1,998	NA	2,359
42 x 72	Static	40EL4272FR2834	1,856	NA	2,170
42 x 84	Static	40EL4284FR2846	2,004	NA	2,356
42 x 90	Static	40EL4290FR2846	2,146	NA	2,524
42 x 96 *	Static	40EL4296FR2858	2,167	NA	2,556
48 x 84	Static	40EL4884FR3446	2,306	NA	2,699
48 x 90	Static	40EL4890FR3446	2,306	NA	2,711
48 x 96 *	Static	40EL4896FR3458	2,334	NA	2,751

* \$200 NET surcharge per order for oversized pallet

For all Justice series table options, please reference pages 126-127.

Top Size	Base	Model Number	3P	3K	3W	D-shaped with Frame & Columns
24 x 36	Static	40D2436FR2222	\$ 1,241	NA	\$ 1,405	
24 x 48	Static	40D2448FR2234	1,338	NA	1,542	
24 x 60	Static	40D2460FR2246	1,444	NA	1,688	
24 x 72	Static	40D2472FR2258	1,529	NA	1,812	
24 x 84	Static	40D2484FR2270	1,640	NA	1,960	
24 x 90	Static	40D2490FR2270	1,678	NA	2,019	
24 x 96 *	Static	40D2496FR2270	1,717	NA	2,077	
30 x 48	Static	40D3048FR2834	1,423	NA	1,648	
30 x 60	Static	40D3060FR2846	1,541	NA	1,805	
30 x 72	Static	40D3072FR2858	1,661	NA	1,967	
30 x 84	Static	40D3084FR2870	1,790	NA	2,136	
30 x 90	Static	40D3090FR2870	1,838	NA	2,205	
30 x 96 *	Static	40D3096FR2870	1,887	NA	2,276	
36 x 48	Static	40D3648FR2834	1,502	NA	1,747	
36 x 60	Static	40D3660FR2846	1,638	NA	1,926	
36 x 72	Static	40D3672FR2858	1,777	NA	2,108	
36 x 84	Static	40D3684FR2870	1,926	NA	2,299	
36 x 90	Static	40D3690FR2870	1,984	NA	2,379	
36 x 96 *	Static	40D3696FR2870	2,043	NA	2,460	
42 x 72	Static	40D4272FR3458	2,141	NA	2,518	
42 x 84	Static	40D4284FR3470	2,201	NA	2,613	
42 x 90	Static	40D4290FR3470	2,280	NA	2,715	
42 x 96 *	Static	40D4296FR3470	2,357	NA	2,814	
48 x 72	Static	40D4872FR4646	2,176	NA	2,570	
48 x 84	Static	40D4884FR4658	2,201	NA	2,627	
48 x 90	Static	40D4890FR4658	2,279	NA	2,727	
48 x 96 *	Static	40D4896FR4670	2,386	NA	2,858	

justice

* \$200 NET surcharge per order for oversized pallet

For all Justice series table options, please reference pages 126-127.

table 

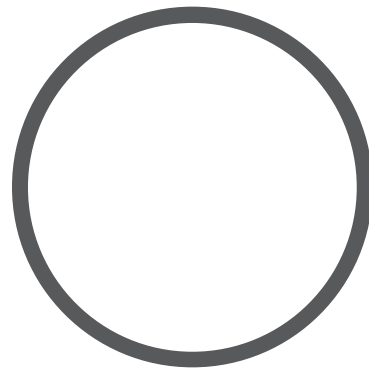

43 artisan
price list
Effective January 1, 2023





Artisan is all about a 'maker-style' aesthetic with the sizes, heights and added versatility you desire. Artisan includes a 500 lb. weight capacity rating for heavy-duty applications. Tables that are 42" or 48" deep will come standard with a Double Rail (.DR) apron that can act as a foot rest.

Artisan Options

Standard
Glides



Industrial
Locking
Casters

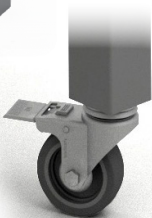

ILC Industrial Locking Casters
can be added to any Justice table for \$332 per set of four.

FD Folding Bases
are not available on Justice tables.

NE Nesting Tables
are not available in the Justice series.

FT Flip Tops
are not available on Justice tables.

WM Wire Management
Built-in wire management is not available on Justice tables.

CH Chrome Finish
is not available on Justice tables.

WMLC Magnetic Wire Management Leg Covers
Magnetically attaches onto any square leg and are \$71 each.

Artisan Top Shapes



Rectangle
p.136

Artisan Rigid Frame with Square Column Legs

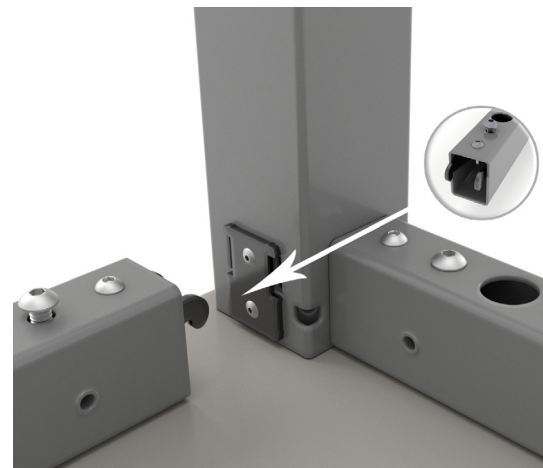



Artisan Top Options

GR **Grommets** can be added to any table for \$45 each. To see specific locations, See page 227. Locations may be adjusted to avoid Justice frame.

BB **Maple Butcher Block** is 1.75" thick with a food-grade clearcoat finish. Available in specific sizes with no grommets and clamp-on power only. Clamp-on power information can be found on page 219.

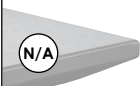

Artisan Edge Options

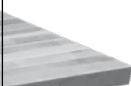
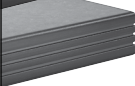

(corresponds with column pricing)



3mm PVC	3mm PVC	3mm Wood	Butcher Block
 <p>3P Flat</p>	 <p>3K Knife</p>	 <p>3W Flat</p>	 <p>BB Maple</p>
 <p>3P Reed</p>	<p>N/A</p>	<p>N/A</p>	<p>Pricing on page 137.</p>

Artisan Series w/ HPL Tops

artisan



Rectangular Static at Standard Height	Top Size	Base	Model Number	3P
 	24 x 60	Single rail	43TC2460FR2157.R-3P	\$ 1,610
	24 x 72	Single rail	43TC2472FR2169.R-3P	1,721
	30 x 60	Single rail	43TC3060FR2757.R-3P	1,705
	30 x 72	Single rail	43TC3072FR2769.R-3P	1,800
	36 x 60	Single rail	43TC3660FR3357.R-3P	1,849
	36 x 72	Single rail	43TC3672FR3369.R-3P	1,938
	42 x 72	Double rail	43TC4272FR3969.DR-3P	2,377
	42 x 96	Double rail	43TC4296FR3993.DR-3P	2,839
	48 x 72	Double rail	43TC4872FR4569.DR-3P	2,482
	48 x 96	Double rail	43TC4896FR4593.DR-3P	2,857



Rectangular Static at Counter Height	Top Size	Base	Model Number	3P
 	24 x 60	Single rail	43TC2460FR2157.R-3P-SH.36	\$ 1,680
	24 x 72	Single rail	43TC2472FR2169.R-3P-SH.36	1,789
	30 x 60	Single rail	43TC3060FR2757.R-3P-SH.36	1,773
	30 x 72	Single rail	43TC3072FR2769.R-3P-SH.36	1,869
	36 x 60	Single rail	43TC3660FR3357.R-3P-SH.36	1,917
	36 x 72	Single rail	43TC3672FR3369.R-3P-SH.36	2,006
	42 x 72	Double rail	43TC4272FR3969.DR-3P-SH.36	2,448
	42 x 96	Double rail	43TC4296FR3993.DR-3P-SH.36	2,912
	48 x 72	Double rail	43TC4872FR4569.DR-3P-SH.36	2,553
	48 x 96	Double rail	43TC4896FR4593.DR-3P-SH.36	2,930



Rectangular Static at Bar Height	Top Size	Base	Model Number	3P
 	24 x 60	Single rail	43TC2460FR2157.R-3P-SH.42	\$ 1,739
	24 x 72	Single rail	43TC2472FR2169.R-3P-SH.42	1,851
	30 x 60	Single rail	43TC3060FR2757.R-3P-SH.42	1,835
	30 x 72	Single rail	43TC3072FR2769.R-3P-SH.42	1,928
	36 x 60	Single rail	43TC3660FR3357.R-3P-SH.42	1,979
	36 x 72	Single rail	43TC3672FR3369.R-3P-SH.42	2,069
	42 x 72	Double rail	43TC4272FR3969.DR-3P-SH.42	2,513
	42 x 96	Double rail	43TC4296FR3993.DR-3P-SH.42	2,977
	48 x 72	Double rail	43TC4872FR4569.DR-3P-SH.42	2,616
	48 x 96	Double rail	43TC4896FR4593.DR-3P-SH.42	2,993

For all Artisan series table options, please reference pages 134-135.

Artisan Series w/ Butcherblock Tops

Top Size	Base	Model Number	BB	Rectangular Static at Standard Height
25 x 60	Single rail	43TC2560FR2157.R-BB	\$ 2,592	 
25 x 72	Single rail	43TC2572FR2169.R-BB	2,878	
30 x 60	Single rail	43TC3060FR2757.R-BB	2,592	
30 x 72	Single rail	43TC3072FR2769.R-BB	2,878	
36 x 60	Single rail	43TC3660FR3357.R-BB	2,872	
36 x 72	Single rail	43TC3672FR3369.R-BB	3,220	
42 x 72	Double rail	43TC4272FR3969.DR-BB	4,785	
42 x 96	Double rail	43TC4296FR3993.DR-BB	6,145	
48 x 72	Double rail	43TC4872FR4569.DR-BB	4,785	
48 x 96	Double rail	43TC4896FR4593.DR-BB	6,145	

Top Size	Base	Model Number	BB	Rectangular Static at Standard Height
25 x 60	Single rail	43TC2560FR2157.R-BB-SH.36	\$ 2,663	 
25 x 72	Single rail	43TC2572FR2169.R-BB-SH.36	2,951	
30 x 60	Single rail	43TC3060FR2757.R-BB-SH.36	2,663	
30 x 72	Single rail	43TC3072FR2769.R-BB-SH.36	2,951	
36 x 60	Single rail	43TC3660FR3357.R-BB-SH.36	2,943	
36 x 72	Single rail	43TC3672FR3369.R-BB-SH.36	3,291	
42 x 72	Double rail	43TC4272FR3969.DR-BB-SH.36	4,860	
42 x 96	Double rail	43TC4296FR3993.DR-BB-SH.36	6,221	
48 x 72	Double rail	43TC4872FR4569.DR-BB-SH.36	4,860	
48 x 96	Double rail	43TC4896FR4593.DR-BB-SH.36	6,221	

Top Size	Base	Model Number	BB	Rectangular Static at Standard Height
25 x 60	Single rail	43TC2560FR2157.R-BB-SH.42	\$ 2,728	 
25 x 72	Single rail	43TC2572FR2169.R-BB-SH.42	3,013	
30 x 60	Single rail	43TC3060FR2757.R-BB-SH.42	2,728	
30 x 72	Single rail	43TC3072FR2769.R-BB-SH.42	3,013	
36 x 60	Single rail	43TC3660FR3357.R-BB-SH.42	3,008	
36 x 72	Single rail	43TC3672FR3369.R-BB-SH.42	3,357	
42 x 72	Double rail	43TC4272FR3969.DR-BB-SH.42	4,926	
42 x 96	Double rail	43TC4296FR3993.DR-BB-SH.42	6,288	
48 x 72	Double rail	43TC4872FR4569.DR-BB-SH.42	4,926	
48 x 96	Double rail	43TC4896FR4593.DR-BB-SH.42	6,288	

For all Artisan series table options, please reference pages 134-135.

tablex

44 primary
price list
Effective January 1, 2023

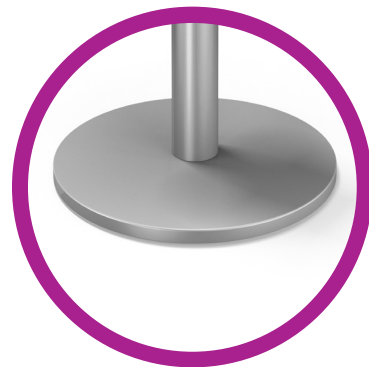





primary

Maximize your foot space with durable traditional column bases. Primary's combination of columns, disc, and drum bases offer alternatives to meet a wide array of applications.

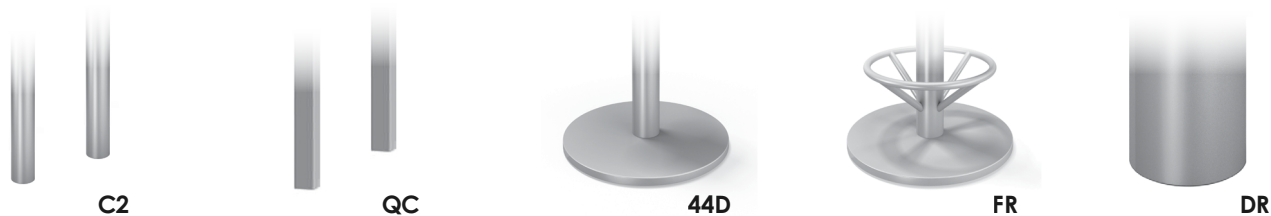
Primary Base Styles



Primary Options

- 

Standard Glides
- 

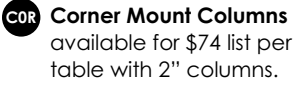
Locking Casters
- 

COR **Corner Mount Columns** available for \$74 list per table with 2" columns.
- LC** **Locking Casters** can be added to any table for \$111 per set of four.
- QC** **Square Columns** are available for an upcharge of \$50 per column.
- FD** **Folding Bases** are not available on Primary tables.
- NE** **Nesting Tables** are not available on Primary tables.
- FT** **Flip Tops** available on some disc-based tables and are priced with standard glides.
- CH** **Chrome Finish** available on 2" columns only for \$49 per column. Upcharge for 44D disc bases is \$454 per base.
- WM** **Wire Management** Built-in wire management is available for \$139 per column.
- WMLC** **Wire Management Leg Covers 2"** snap onto round columns and are \$50 each.
- MMLC** **Magnetic Wire Management Leg Covers** Magnetically attaches onto any square leg and are \$71 each.
- SH** **Special Height** can be added to any table:
 + \$72 per column for heights > 29"
 + \$50 per column for heights < 29"
 Special height tables with tops larger than 36x72" must be custom quoted.
- FR** **Footring** available on standing height disc-bases for \$166 per base. Not available in chrome.
- PB** **Powerbox Mounting Plate** is available on disc bases for \$100.

Primary Height Adjustable Options

- NU Pneumatic** is available on disc bases for \$387 per table. For height option details, see page 19.
- AH Spring Clip** is available on X-bases for \$139 and on round column bases for \$555 per table. Not available in chrome. For height option details, see page 19.
- EX Manual Extended Height** is available on 2" columns for \$310 per table. For height option details, see page 19.
- BL Counterbalanced and Short Balanced** and **BLS** are available on disc bases. Available height adjustable finishes can be found on page 9.

Primary Top Shapes

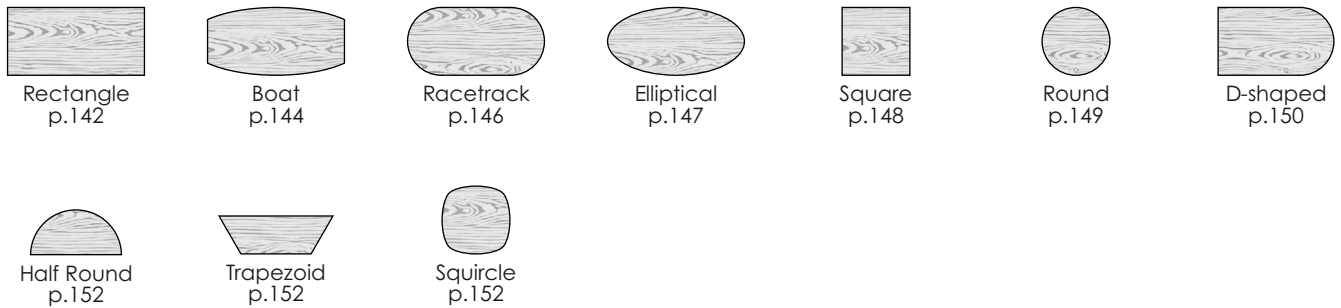

primary

Primary Top Options

- QG Quick-Connect Ganging Brackets** can be added to any table for \$45 (includes 4 connectors per table).
- RC 3" Radius Corners** can be added to any table for \$61.
- GR Grommets** can be added to any table for \$45 each. To see specific locations, see page 227.

Primary Edge Options

(corresponds with 3 columns of pricing)

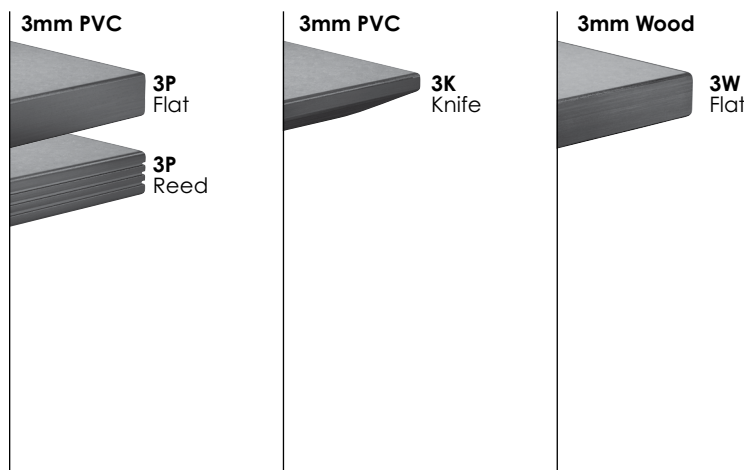

Rectangular with Column Bases	Top Size	Base	Model Number	3P	3K	3W
-------------------------------	----------	------	--------------	----	----	----



18 x 36	Static	44TC1836C2	\$ 648	\$ 701	\$ 802
18 x 48	Static	44TC1848C2	691	763	880
18 x 60	Static	44TC1860C2	824	913	1,048
18 x 72	Static	44TC1872C2	868	974	1,127
18 x 84	Static	44TC1884C2	911	1,035	1,206
18 x 90	Static	44TC1890C2	955	1,096	1,270
18 x 96 *	Static	44TC1896C2	955	1,096	1,286
20 x 36	Static	44TC2036C2	690	761	853
20 x 48	Static	44TC2048C2	747	842	947
20 x 60	Static	44TC2060C2	863	966	1,096
20 x 72	Static	44TC2072C2	912	1,036	1,182
20 x 84	Static	44TC2084C2	1,008	1,171	1,318
20 x 90	Static	44TC2090C2	1,066	1,251	1,397
20 x 96 *	Static	44TC2096C2	1,066	1,251	1,412
24 x 36	Static	44TC2436C2	690	761	864
24 x 48	Static	44TC2448C2	747	842	958
24 x 60	Static	44TC2460C2	863	966	1,107
24 x 72	Static	44TC2472C2	912	1,036	1,191
24 x 84	Static	44TC2484C2	1,008	1,171	1,329
24 x 90	Static	44TC2490C2	1,066	1,251	1,407
24 x 96 *	Static	44TC2496C2	1,066	1,251	1,423
30 x 36	Static	44TC3036C2	733	822	926
30 x 48	Static	44TC3048C2	804	920	1,035
30 x 60	Static	44TC3060C2	914	1,040	1,179
30 x 72	Static	44TC3072C2	970	1,118	1,271
30 x 84	Static	44TC3084C2	1,106	1,308	1,451
30 x 90	Static	44TC3090C2	1,176	1,406	1,546
30 x 96 *	Static	44TC3096C2	1,176	1,406	1,561
36 x 48	Static	44TC3648C2	859	999	1,112
36 x 60	Static	44TC3660C2	1,033	1,206	1,326
36 x 72	Static	44TC3672C2	1,087	1,281	1,416
36 x 84	Static	44TC3684C2	1,203	1,443	1,574
36 x 90	Static	44TC3690C2	1,287	1,561	1,682
36 x 96 *	Static	44TC3696C2	1,287	1,561	1,696

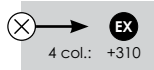

* \$200 NET surcharge per order for oversized pallet

For Primary series table options, please reference pages 140-141.

Top Size	Base	Model Number	3P	3K	3W	Rectangular with 2 Disc Bases
24 x 60	Static	44TC2460D20	\$ 1,797	\$ 1,902	\$ 2,042	
24 x 72	Static	44TC2472D20	1,846	1,971	2,127	
24 x 84	Static	44TC2484D20	2,032	2,194	2,351	
24 x 90	Static	44TC2490D20	2,089	2,275	2,431	
24 x 96 *	Static	44TC2496D20	2,089	2,275	2,446	
30 x 60	Static	44TC3060D20	1,848	1,974	2,113	
30 x 72	Static	44TC3072D20	1,905	2,053	2,205	
30 x 84	Static	44TC3084D20	2,129	2,330	2,474	
30 x 90	Static	44TC3090D20	2,199	2,430	2,569	
30 x 96 *	Static	44TC3096D20	2,199	2,430	2,585	
36 x 72	Static	44TC3672D24	2,131	2,325	2,460	
36 x 84	Static	44TC3684D24	2,336	2,576	2,706	
36 x 90	Static	44TC3690D24	2,420	2,694	2,814	
36 x 96 *	Static	44TC3696D24	2,420	2,694	2,830	
42 x 72	Static	44TC4272D32	2,601	2,844	2,958	
42 x 84	Static	44TC4284D32	2,787	3,069	3,184	
42 x 90	Static	44TC4290D32	2,881	3,200	3,303	
42 x 96 *	Static	44TC4296D32	2,881	3,201	3,318	

CH +908
SH +143
← 2 disc bases: ⊗

primary

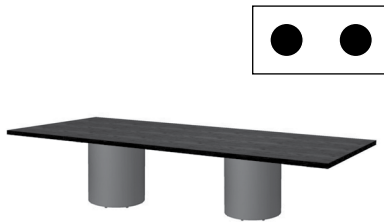
Top Size	Base	Model Number	3P	3K	3W	Rectangular with Drum Bases
30 x 60	Drum	44TC3060DR18	\$ 4,813	\$ 4,938	\$ 5,077	
30 x 72	Drum	44TC3072DR18	4,867	5,015	5,170	
30 x 84	Drum	44TC3084DR18	5,003	5,204	5,349	
30 x 90	Drum	44TC3090DR18	5,163	5,393	5,531	
30 x 96 *	Drum	44TC3096DR18	5,163	5,393	5,547	
36 x 60	Drum	44TC3660DR18	4,931	5,105	5,223	
36 x 72	Drum	44TC3672DR18	4,984	5,178	5,312	
36 x 84	Drum	44TC3684DR18	5,101	5,342	5,472	
36 x 90	Drum	44TC3690DR18	5,274	5,547	5,667	
36 x 96 *	Drum	44TC3696DR18	5,274	5,547	5,683	
42 x 72	Drum	44TC4272DR24	5,383	5,625	5,739	
42 x 84	Drum	44TC4284DR24	5,479	5,761	5,876	
42 x 90	Drum	44TC4290DR24	5,661	5,980	6,082	
42 x 96 *	Drum	44TC4296DR24	5,661	5,980	6,099	
48 x 72	Drum	44TC4872DR24	5,468	5,746	5,849	
48 x 84	Drum	44TC4884DR24	5,479	5,761	5,892	
48 x 90	Drum	44TC4890DR24	5,662	5,982	6,100	
48 x 96 *	Drum	44TC4896DR24	5,662	5,982	6,116	

* \$200 NET surcharge per order for oversized pallet

For Primary series table options, please reference pages 140-141.

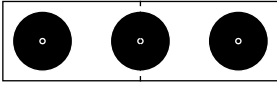
Rectangular with 3 Disc Bases	Top Size	Base	Model Number	3P	3K	3W
	42 x 120	Static	44TC42120D32(3)	\$ 4,232	\$ 4,707	\$ 4,771
	42 x 144	Static	44TC42144D32(3)	4,426	4,977	5,046

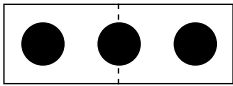

CH SH ← ⊗
 +1,361 +215 3 disc bases:

Rectangular with 3 Drum Bases	Top Size	Base	Model Number	3P	3K	3W
	42 x 120	Drum	44TC42120DR24(3)	\$ 8,402	\$ 8,876	\$ 8,941
	42 x 144	Drum	44TC42144DR24(3)	8,596	9,148	9,216
	48 x 120	Drum	44TC48120DR24(3)	8,414	8,893	8,970
	48 x 144	Drum	44TC48144DR24(3)	8,610	9,167	9,248

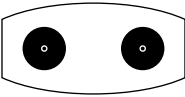

CH SH ← ⊗
 N/A N/A Drum bases:

Boat-shaped with 2 Disc Bases	Top Size	Base	Model Number	3P	3K	3W
	30 x 42 x 84	Static	44BT3084D24	\$ 2,688	\$ 3,072	\$ 3,064
	30 x 42 x 90	Static	44BT3090D24	2,825	3,261	3,229
	30 x 42 x 96 *	Static	44BT3096D24	2,825	3,261	3,245
	36 x 48 x 84	Static	44BT3684D32	3,173	3,608	3,569
	36 x 48 x 90	Static	44BT3690D32	3,326	3,824	3,755
	36 x 48 x 96 *	Static	44BT3696D32	3,326	3,824	3,770

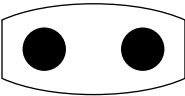

⊗ → CH SH
 2 thin disc bases: +908 +143

Boat-shaped with 2 Drum Bases	Top Size	Base	Model Number	3P	3K	3W
	30 x 42 x 84	Drum	44BT3084DR18	\$ 5,454	\$ 5,836	\$ 5,830
	30 x 42 x 90	Drum	44BT3090DR18	5,678	6,115	6,082
	30 x 42 x 96 *	Drum	44BT3096DR18	5,678	6,115	6,098
	36 x 48 x 84	Drum	44BT3684DR24	5,864	6,299	6,262
	36 x 48 x 90	Drum	44BT3690DR24	6,106	6,604	6,536
	36 x 48 x 96 *	Drum	44BT3696DR24	6,106	6,604	6,551



⊗ → CH SH
 Drum bases: N/A N/A

* \$200 NET surcharge per order for oversized pallet

For Primary series table options, please reference pages 140-141.

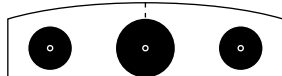
Top Size	Base	Model Number	3P	3K	3W	Boat-shaped with 3 Disc Bases
36 x 48 x 120	Static	44BT36120D243224	\$4,442	\$5,140	\$4,998	
36 x 48 x 144	Static	44BT36144D243224	4,751	5,571	5,400	

CH SH ← ⊗
 +1,361 +215 3 disc bases:



Top Size	Base	Model Number	3P	3K	3W	Boat-shaped with 3 Drum Bases
36 x 48 x 120	Drum	44BT36120DR182418	\$8,685	\$9,383	\$9,243	
36 x 48 x 144	Drum	44BT36144DR182418	8,994	9,815	9,644	

CH SH ← ⊗
 N/A N/A Drum bases:



primary

For Primary series table options, please reference pages 140-141.

Racetrack with 2 Disc Bases	Top Size	Base	Model Number	3P	3K	3W
	36 x 72	Static	44RT3672D20	\$2,241	\$2,524	\$2,551
	36 x 84	Static	44RT3684D20	2,576	2,957	2,943
	36 x 90	Static	44RT3690D20	2,716	3,150	3,110
	36 x 96 *	Static	44RT3696D20	2,716	3,150	3,125
	42 x 84	Static	44RT4284D24	2,685	3,068	3,060
	42 x 90	Static	44RT4290D24	2,825	3,261	3,229
	42 x 96 *	Static	44RT4296D24	2,825	3,261	3,245
	48 x 84	Static	44RT4884D32	3,326	3,824	3,740
	48 x 90	Static	44RT4890D32	3,326	3,824	3,755
	48 x 96 *	Static	44RT4896D32	3,326	3,824	3,770

2 disc bases: CH +908 SH +143

Racetrack with 2 Drum Bases	Top Size	Base	Model Number	3P	3K	3W
	36 x 72	Drum	44RT3672DR18	\$5,204	\$5,486	\$5,515
	36 x 84	Drum	44RT3684DR18	5,451	5,832	5,816
	36 x 90	Drum	44RT3690DR18	5,678	6,115	6,074
	36 x 96 *	Drum	44RT3696DR18	5,678	6,115	6,089
	42 x 84	Drum	44RT4284DR18	5,451	5,832	5,827
	42 x 90	Drum	44RT4290DR18	5,678	6,115	6,082
	42 x 96 *	Drum	44RT4296DR18	5,678	6,115	6,098
	48 x 84	Drum	44RT4884DR24	6,018	6,516	6,432
	48 x 90	Drum	44RT4890DR24	6,106	6,604	6,536
	48 x 96 *	Drum	44RT4896DR24	6,106	6,604	6,551

Drum bases: CH N/A SH N/A

Racetrack with 3 Disc Bases	Top Size	Base	Model Number	3P	3K	3W
	42 x 120	Static	44RT42120D24(3)	\$4,250	\$4,942	\$4,796
	42 x 144	Static	44RT42144D24(3)	4,555	5,368	5,194
	48 x 120	Static	44RT48120D32(3)	4,792	5,489	5,348
	48 x 144	Static	44RT48144D32(3)	5,100	5,920	5,749

3 disc bases: CH +1,361 SH +215

* \$200 NET surcharge per order for oversized pallet

For Primary series table options, please reference pages 140-141.

Top Size	Base	Model Number	3P	3K	3W	Racetrack with 3 Drum Bases
42 x 120	Drum	44RT42120DR18(3)	\$ 8,531	\$ 9,222	\$ 9,077	
42 x 144	Drum	44RT42144DR18(3)	8,835	9,649	9,475	
48 x 120	Drum	44RT48120DR24(3)	8,962	9,660	9,519	
48 x 144	Drum	44RT48144DR24(3)	9,271	10,091	9,920	

Top Size	Base	Model Number	3P	3K	3W	Elliptical with 2 Disc Bases
36 x 72	Static	44EL3672D20	\$ 2,241	\$ 2,524	\$ 2,531	
36 x 84	Static	44EL3684D20	2,447	2,777	2,775	
36 x 90	Static	44EL3690D20	2,561	2,936	2,911	
36 x 96 *	Static	44EL3696D20	2,561	2,936	2,924	
42 x 72	Static	44EL4272D24	2,469	2,798	2,784	
42 x 84	Static	44EL4284D24	2,685	3,068	3,037	
42 x 90	Static	44EL4290D24	2,827	3,264	3,205	
42 x 96 *	Static	44EL4296D24	2,827	3,264	3,217	
48 x 84	Static	44EL4884D32	3,327	3,825	3,720	
48 x 90	Static	44EL4890D32	3,327	3,825	3,733	
48 x 96 *	Static	44EL4896D32	3,327	3,825	3,745	

Top Size	Base	Model Number	3P	3K	3W	Elliptical with 2 Drum Bases
36 x 72	Drum	44EL3672DR18	\$ 5,204	\$ 5,486	\$ 5,495	
36 x 84	Drum	44EL3684DR18	5,323	5,653	5,649	
36 x 90	Drum	44EL3690DR18	5,525	5,899	5,874	
36 x 96 *	Drum	44EL3696DR18	5,525	5,899	5,886	
42 x 72	Drum	44EL4272DR18	5,323	5,653	5,637	
42 x 84	Drum	44EL4284DR18	5,451	5,832	5,803	
42 x 90	Drum	44EL4290DR18	5,680	6,118	6,058	
42 x 96 *	Drum	44EL4296DR18	5,680	6,118	6,071	
48 x 84	Drum	44EL4884DR24	6,019	6,517	6,412	
48 x 90	Drum	44EL4890DR24	6,107	6,605	6,513	
48 x 96 *	Drum	44EL4896DR24	6,107	6,605	6,524	

* \$200 NET surcharge per order for oversized pallet

For Primary series table options, please reference pages 140-141.

Elliptical with 3 Disc Bases	Top Size	Base	Model Number	3P	3K	3W
	42 x 120	Static	44EL42120D202420	\$ 4,141	\$ 4,832	\$ 4,644
	42 x 144	Static	44EL42144D202420	4,446	5,259	5,027
	48 x 120	Static	44EL48120D243224	4,443	5,140	4,959
	48 x 144	Static	44EL48144D243224	4,751	5,572	5,347

CH +1,361 SH +215 3 disc bases: X

Elliptical with 3 Drum Bases	Top Size	Base	Model Number	3P	3K	3W
	42 x 120	Drum	44EL42120DR182418	\$ 8,669	\$ 9,359	\$ 9,170
	42 x 144	Drum	44EL42144DR182418	8,974	9,786	9,555
	48 x 120	Drum	44EL48120DR182418	8,686	9,383	9,203
	48 x 144	Drum	44EL48144DR182418	8,994	9,816	9,590

CH N/A SH N/A Drum bases: X

Square with Column Bases	Top Size	Base	Model Number	3P	3K	3W
<p>EX Manual Extended Height</p>	24 x 24	Static	44SQ2424C2	\$ 633	\$ 681	\$ 769
	30 x 30	Static	44SQ3030C2	697	770	871
	36 x 36	Static	44SQ3636C2	775	879	987
	42 x 42	Static	44SQ4242C2	867	1,008	1,120
	48 x 48	Static	44SQ4848C2	973	1,157	1,267
	54 x 54	Static	44SQ5454C2	1,091	1,322	1,428
	60 x 60	Static	44SQ6060C2	1,313	1,598	1,694

Square with Disc Base	Top Size	Base	Model Number	3P	3K	3W
<p>BLS Short Balanced Ht. Adjustable</p> <p>BL Counter-balanced Ht. Adjustable</p>	24 x 24	Static	44SQ2424D20	\$ 921	\$ 969	\$ 1,057
		Short Bal	44SQ2424D20BLS	1,538	1,586	1,674
	30 x 30	Static	44SQ3030D24	1,041	1,115	1,213
		Short Bal	44SQ3030D24BLS	1,963	2,037	2,137
	36 x 36	Static	44SQ3636D24	1,118	1,223	1,331
		Short Bal	44SQ3636D24BLS	2,041	2,147	2,254
		Count Bal	44SQ3636D24BL	2,041	2,147	2,254
	42 x 42	Static	44SQ4242D32	1,384	1,526	1,638
		Short Bal	44SQ4242D32BLS	2,300	2,441	2,552
		Count Bal	44SQ4242D32BL	2,300	2,441	2,552

X Disc bases: CH +454 SH +72

For Primary series table options, please reference pages 140-141.

Top Size	Base	Model Number	3P	3K	3W	Square with Drum Base
30 x 30	Drum	44SQ3030DR18	\$2,467	\$2,541	\$2,641	
36 x 36	Drum	44SQ3636DR18	2,545	2,651	2,757	
42 x 42	Drum	44SQ4242DR24	2,775	2,916	3,028	
48 x 48	Drum	44SQ4848DR24	2,880	3,063	3,175	
54 x 54	Drum	44SQ5454DR28	3,458	3,690	3,796	
60 x 60	Drum	44SQ6060DR28	3,590	3,875	3,974	

Drum bases: CH N/A SH N/A

Top Size	Base	Model Number	3P	3K	3W	Round with Column Bases
24 x 24	Static	44RD24C2	\$ 672	\$ 737	\$ 786	
30 x 30	Static	44RD30C2	760	858	907	
36 x 36	Static	44RD36C2	852	987	1,033	
42 x 42	Static	44RD42C2	975	1,159	1,190	
48 x 48	Static	44RD48C2	1,008	1,206	1,253	
54 x 54	Static	44RD54C2	1,207	1,485	1,497	
60 x 60	Static	44RD60C2	1,235	1,525	1,552	

EX Manual Extended Height

Top Size	Base	Model Number	3P	3K	3W	Round with Disc Base
24 x 24	Static	44RD24D20	\$ 961	\$1,024	\$1,075	
	Short Bal	44RD24D20BLS	1,578	1,642	1,691	
30 x 30	Static	44RD30D20	1,048	1,146	1,195	
	Short Bal	44RD30D20BLS	1,665	1,763	1,813	
36 x 36	Static	44RD36D20	1,140	1,275	1,320	
	Short Bal	44RD36D20BLS	1,757	1,893	1,938	
	Count Bal	44RD36D20BL	1,757	1,893	1,938	
42 x 42	Static	44RD42D24	1,317	1,502	1,535	
	Short Bal	44RD42D24BLS	2,240	2,424	2,457	
	Count Bal	44RD42D24BL	2,240	2,424	2,457	
48 x 48	Static	44RD48D32	1,526	1,725	1,771	
	Short Bal	44RD48D32BLS	2,441	2,638	2,685	
	Count Bal	44RD48D32BL	2,441	2,638	2,685	

BLS Short Balanced Ht. Adjustable
BL Counter-balanced Ht. Adjustable

CH +454 SH +72 Disc bases:

Top Size	Base	Model Number	3P	3K	3W	Round with Drum Base
30 x 30	Drum	44RD30DR18	\$2,530	\$2,629	\$2,677	
36 x 36	Drum	44RD36DR18	2,621	2,757	2,803	
42 x 42	Drum	44RD42DR24	2,882	3,065	3,099	
48 x 48	Drum	44RD48DR24	2,916	3,115	3,161	
54 x 54	Drum	44RD54DR24	3,116	3,393	3,405	
60 x 60	Drum	44RD60DR28	3,602	3,891	3,918	

CH N/A SH N/A Drum bases:

For Primary series table options, please reference pages 140-141.

D-shaped with Column Bases	Top Size	Base	Model Number	3P	3K	3W
	24 x 36	Static	44D2436C2	\$ 747	\$ 842	\$ 913
	24 x 48	Static	44D2448C2	826	951	1,029
	24 x 60	Static	44D2460C2	903	1,059	1,146
	24 x 72	Static	44D2472C2	1,070	1,257	1,353
	24 x 84	Static	44D2484C2	1,149	1,367	1,469
	24 x 90	Static	44D2490C2	1,187	1,422	1,528
	24 x 96 *	Static	44D2496C2	1,226	1,476	1,586
	30 x 48	Static	44D3048C2	903	1,059	1,128
	30 x 60	Static	44D3060C2	1,001	1,197	1,267
	30 x 72	Static	44D3072C2	1,187	1,422	1,494
30 x 84	Static	44D3084C2	1,286	1,559	1,632	
30 x 90	Static	44D3090C2	1,334	1,627	1,701	
30 x 96 *	Static	44D3096C2	1,382	1,695	1,771	
36 x 48	Static	44D3648C2	982	1,169	1,226	
36 x 60	Static	44D3660C2	1,099	1,333	1,385	
36 x 72	Static	44D3672C2	1,305	1,585	1,635	
36 x 84	Static	44D3684C2	1,422	1,750	1,795	
36 x 90	Static	44D3690C2	1,481	1,833	1,875	
36 x 96 *	Static	44D3696C2	1,539	1,914	1,955	



D-shaped with 2 Drum Bases	Top Size	Base	Model Number	3P	3K	3W
	30 x 60	Drum	44D3060DR18	\$ 4,988	\$ 5,182	\$ 5,254
	30 x 72	Drum	44D3072DR18	5,086	5,320	5,391
	30 x 84	Drum	44D3084DR18	5,273	5,546	5,618
	30 x 90	Drum	44D3090DR18	5,321	5,613	5,687
	30 x 96 *	Drum	44D3096DR18	5,369	5,681	5,758
	36 x 72	Drum	44D3672DR18	5,202	5,484	5,532
	36 x 84	Drum	44D3684DR18	5,408	5,737	5,782
	36 x 90	Drum	44D3690DR18	5,467	5,819	5,861
	36 x 96 *	Drum	44D3696DR18	5,526	5,900	5,941
	42 x 72	Drum	44D4272DR24	5,826	6,246	6,203
42 x 84	Drum	44D4284DR24	5,947	6,380	6,358	
42 x 90	Drum	44D4290DR24	6,024	6,488	6,458	
42 x 96 *	Drum	44D4296DR24	6,101	6,597	6,560	
48 x 72	Drum	44D4872DR24	5,870	6,307	6,263	
48 x 84	Drum	44D4884DR24	5,958	6,395	6,382	
48 x 90	Drum	44D4890DR24	6,036	6,504	6,483	
48 x 96 *	Drum	44D4896DR24	6,115	6,613	6,585	



* \$200 NET surcharge per order for oversized pallet

For Primary series table options, please reference pages 140-141.

Top Size	Base	Model Number	3P	3K	3W	D-shaped with 2 Disc Bases
24 x 60	Static	44D2460D20	\$ 1,927	\$ 2,084	\$ 2,171	
24 x 72	Static	44D2472D20	2,005	2,193	2,287	
24 x 84	Static	44D2484D20	2,172	2,390	2,492	
24 x 90	Static	44D2490D20	2,211	2,445	2,551	
24 x 96 *	Static	44D2496D20	2,250	2,499	2,610	
30 x 60	Static	44D3060D20	2,024	2,220	2,289	
30 x 72	Static	44D3072D20	2,123	2,357	2,429	
30 x 84	Static	44D3084D20	2,308	2,582	2,656	
30 x 90	Static	44D3090D20	2,357	2,651	2,724	
30 x 96 *	Static	44D3096D20	2,406	2,719	2,793	
36 x 72	Static	44D3672D24	2,349	2,631	2,679	
36 x 84	Static	44D3684D24	2,554	2,883	2,928	
36 x 90	Static	44D3690D24	2,614	2,965	3,008	
36 x 96 *	Static	44D3696D24	2,673	3,048	3,087	
42 x 72	Static	44D4272D32	3,045	3,465	3,422	
42 x 84	Static	44D4284D32	3,166	3,600	3,578	
42 x 90	Static	44D4290D32	3,244	3,708	3,679	
42 x 96 *	Static	44D4296D32	3,322	3,817	3,779	

CH +908
SH +143
← 2 disc bases: (X)

primary

* \$200 NET surcharge per order for oversized pallet

For Primary series table options, please reference pages 140-141.

Half Round with Column Bases	Top Size	Base	Model Number	3P	3K	3W
	18 x 36	Static	44HR1836C2(3)	\$ 646	\$ 744	\$ 790
	24 x 48	Static	44HR2448C2(3)	718	845	910
	30 x 60	Static	44HR3060C2	1,003	1,200	1,252
	36 x 72	Static	44HR3672C2	1,304	1,584	1,613



Trapezoid with Column Bases	Top Size	Base	Model Number	3P	3K	3W
	24 x 48	Static	44TZ2448C2	\$ 595	\$ 718	\$ 786
	24 x 72	Static	44TZ2472C2	793	996	1,084
	30 x 60	Static	44TZ3060C2	727	902	971
	36 x 72	Static	44TZ3672C2	963	1,233	1,271



Squircle with Column Bases	Top Size	Base	Model Number	3P	3K	3W
	24 x 24	Static	44SL24C2	\$ 854	\$ 990	\$ 1,012
	30 x 30	Static	44SL30C2	913	1,073	1,108
	36 x 36	Static	44SL36C2	979	1,164	1,211
	42 x 42	Static	44SL42C2	1,050	1,266	1,321
	48 x 48	Static	44SL48C2	1,137	1,385	1,447

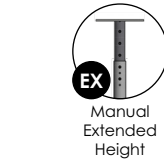

For Primary series table options, please reference pages 140-141.

For Primary series table options, please reference pages 140-141.

table 

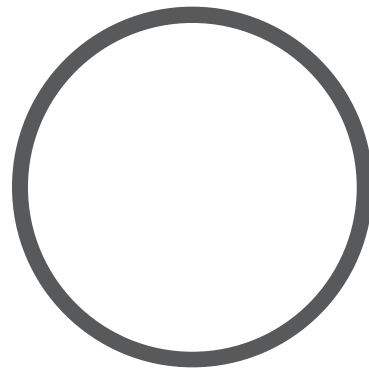

45 puddle
price list
Effective January 1, 2023

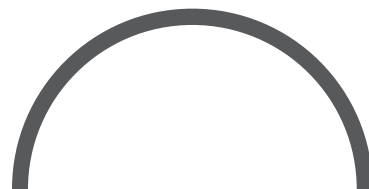



A base that seems to melt into the floor. Puddle is a clean and simple solution. Available on square, round, rectangle, squircle, and racetrack tables.

Puddle Base

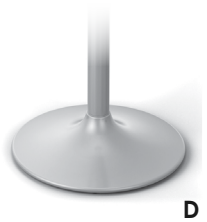

D

Puddle Options

- LC** **Locking Casters**
are not available on Puddle tables.
- FD** **Folding Bases**
are not available on Puddle tables.
- NE** **Nesting Tables**
are not available on Puddle tables.
- FT** **Flip Tops**
are not available on Puddle tables.
- CH** **Chrome Finish**
available for \$475 per base. Brushed Steel is not available on Puddle tables.
- WM** **Wire Management**
Built-in wire management is available on one leg for \$139 per column.
- WMLC** **Wire Management Leg Covers 3"**
snap onto any leg and are \$79 each.
- SH** **Special Height**
can be added to any table:
+ \$72 per column for heights > 29"
+ \$39 per column for heights < 29"
Special height tables with tops larger than 36x72" must be custom quoted.
- FR** **Footring**
is available on Puddle tables for \$166.
- PB** **Powerbox Mounting Plate**
is available on disc bases for \$100.

Puddle Height Adjustable Options

- AH Spring Clip** is available on disc bases for \$139 per base. Not available in chrome. For height option details, see page 19.
- BL Counterbalanced and Short Balanced** are available on single disc bases. Available height adjustable finishes can be found on page 9.
- NU Pneumatic** is available on Puddle disc base for \$387. For height option details, see page 19.

Puddle Top Shapes



Square p.158



Rectangle p.158



Round p.159



Squircle p.159



Racetrack p.159



puddle

Puddle Top Options

- QG Quick-Connect Ganging Brackets** can be added to any table for \$45 (includes 4 connectors per table).
- RC 3" Radius Corners** can be added to any table for \$61.
- GR Grommets** can be added to any table for \$45 each. To see specific locations, see page 227.

Puddle Edge Options

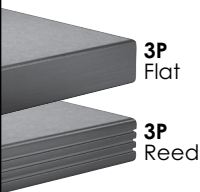
(corresponds with 3 columns of pricing)

3mm PVC	3mm PVC	3mm Wood
 <p>3P Flat</p> <p>3P Reed</p>	 <p>3K Knife</p>	 <p>3W Flat</p>

Square with Disc Base		Top Size	Base	Model Number	3P	3K	3W
	24 x 24	Static		45SQ2424D22	\$ 798	\$ 846	\$ 934
		Short Bal		45SQ2424D22BLS	1,750	1,797	1,885
	30 x 30	Static		45SQ3030D22	863	936	1,036
		Short Bal		45SQ3030D22BLS	1,814	1,887	1,988
		Count Bal		45SQ3030D22BL	1,814	1,887	1,988
	36 x 36	Static		45SQ3636D26	990	1,095	1,203
Short Bal			45SQ3636D26BLS	2,335	2,441	2,548	
Count Bal			45SQ3636D26BL	2,335	2,441	2,548	

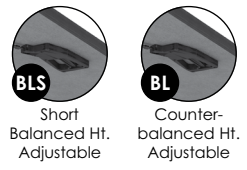

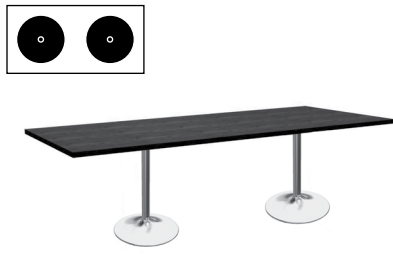
Rectangular with Disc Bases		Top Size	Base	Model Number	3P	3K	3W
	24 x 60	Static		45TC2460D22	\$ 1,551	\$ 1,654	\$ 1,795
	24 x 72	Static		45TC2472D22	1,601	1,725	1,880
	24 x 84	Static		45TC2484D22	1,784	1,947	2,106
	24 x 90	Static		45TC2490D22	1,842	2,027	2,183
	24 x 96 *	Static		45TC2496D22	1,842	2,027	2,199
	30 x 60	Static		45TC3060D22	1,602	1,728	1,866
	30 x 72	Static		45TC3072D22	1,658	1,805	1,959
	30 x 84	Static		45TC3084D22	1,882	2,084	2,228
	30 x 90	Static		45TC3090D22	1,953	2,182	2,322
	30 x 96 *	Static		45TC3096D22	1,953	2,182	2,337
	36 x 72	Static		45TC3672D26	1,875	2,069	2,203
	36 x 84	Static		45TC3684D26	2,081	2,321	2,451
	36 x 90	Static		45TC3690D26	2,165	2,438	2,558
	36 x 96 *	Static		45TC3696D26	2,165	2,438	2,574
	42 x 72	Static		45TC4272D26	1,997	2,239	2,352
	42 x 84	Static		45TC4284D26	2,181	2,463	2,578
	42 x 90	Static		45TC4290D26	2,276	2,595	2,698
	42 x 96 *	Static		45TC4296D26	2,276	2,595	2,713



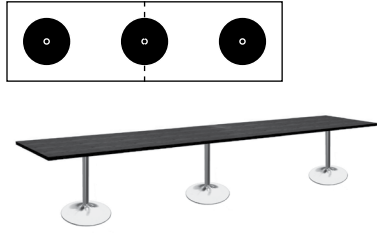





Rectangular with 3 Disc Bases		Top Size	Base	Model Number	3P	3K	3W
	42 x 120	Static		45TC42120D26(3)	\$ 3,325	\$ 3,798	\$ 3,863
	42 x 144	Static		45TC42144D26(3)	3,519	4,070	4,139



* \$200 NET surcharge per order for oversized pallet

For Puddle series table options, please reference pages 156-157.

Top Size	Base	Model Number	3P	3K	3W	Round with Disc Base
24 x 24	Static	45RD24D22	\$ 837	\$ 900	\$ 952	    <p>Short Balanced Ht. Adjustable</p> <p>Counter-balanced Ht. Adjustable</p>
	Short Bal	45RD24D22BLS	1,790	1,853	1,903	
30 x 30	Static	45RD30D22	924	1,023	1,071	
	Short Bal	45RD30D22BLS	1,877	1,974	2,023	
36 x 36	Static	45RD36D22	1,017	1,152	1,197	
	Short Bal	45RD36D22BLS	1,968	2,105	2,149	
	Count Bal	45RD36D22BL	1,968	2,105	2,149	
42 x 42	Static	45RD42D26	1,189	1,374	1,406	
	Short Bal	45RD42D26BLS	2,534	2,719	2,751	
	Count Bal	45RD42D26BL	2,534	2,719	2,751	

Top Size	Base	Model Number	3P	3K	3W	Squircle with Disc Base
24 x 24	Static	45SL24D22	\$ 1,019	\$ 1,155	\$ 1,178	    <p>Short Balanced Ht. Adjustable</p> <p>Counter-balanced Ht. Adjustable</p>
	Short Bal	45SL24D22BLS	1,970	2,107	2,129	
30 x 30	Static	45SL30D22	1,078	1,238	1,273	
	Short Bal	45SL30D22BLS	2,029	2,190	2,224	
	Count Bal	45SL30D22BL	2,029	2,190	2,224	
36 x 36	Static	45SL36D26	1,194	1,380	1,426	
	Short Bal	45SL36D26BLS	2,539	2,725	2,771	
	Count Bal	45SL36D26BL	2,539	2,725	2,771	

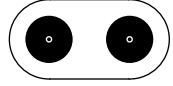
Top Size	Base	Model Number	3P	3K	3W	Racetrack with Disc Base
36 x 72	Static	45RT3672D26	\$ 2,094	\$ 2,377	\$ 2,406	 
36 x 84	Static	45RT3684D26	2,430	2,811	2,796	
36 x 90	Static	45RT3690D26	2,569	3,006	2,965	
36 x 96 *	Static	45RT3696D26	2,569	3,006	2,980	
42 x 84	Static	45RT4284D26	2,430	2,811	2,805	
42 x 90	Static	45RT4290D26	2,569	3,006	2,973	
42 x 96 *	Static	45RT4296D26	2,569	3,006	2,989	

CH +569 ← 2 disc bases: (X)

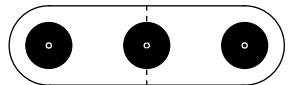
Top Size	Base	Model Number	3P	3K	3W	Racetrack with 3 Disc Base
42 x 120	Static	45RT42120D26(3)	\$ 3,867	\$ 4,557	\$ 4,413	 
42 x 144	Static	45RT42145D26(3)	4,172	4,984	4,811	

CH +853 ← 3 disc bases: (X)

* \$200 NET surcharge per order for oversized pallet

For Puddle series table options, please reference pages 156-157.

table 

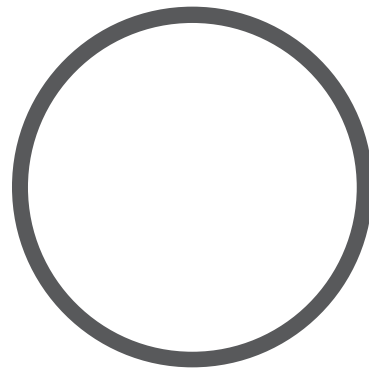

71 exclaim
price list
Effective January 1, 2023

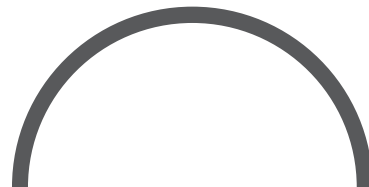



Exclaim is both simple, yet sophisticated. These angled square columns build a collection of attractive tables with a variety of base configurations.

Exclaim Base Configurations

exclaim



A Configuration



V Configuration



X Configuration



Exclaim Options

Angled 2" Column with Standard Glides

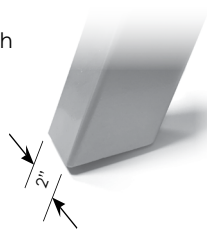

Angled 3" Column with Standard Glides

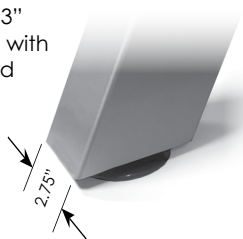

LC **Locking Casters** are not available on Exclaim tables.

FD **Folding Bases** are not available on Exclaim tables.

NE **Nesting Tables** are not available on Exclaim tables.

FT **Flip Tops** are not available on Exclaim tables.

PB **Powerbox Mounting Plate** is not available on Exclaim tables.

CH **Chrome Finish** ONLY available on Exclaim 3" angled columns at Standard or Lounge heights for \$119 per column. (Not available on 2" columns)

WMH **Wire Management Holes** Two built-in wire management mouse holes available for \$34 per leg on the 3" columns only. Not available on chrome.

MMLC **Magnetic Wire Management Leg Covers** Magnetically attaches onto any square leg and are \$71 each.

SH **Special Heights** of 42" are available on all standard Exclaim tables for \$56 per column. Special height of 18" is available on select Exclaim models shown on pages 164-165. Other custom heights are not available on Exclaim.

Exclaim Top Shapes



Rectangle
p.166



Boat
p.168



Racetrack
p.169



Elliptical
p.170



D-shaped
p.172



Square
p.173



Round
p.173

Exclaim Lounge Height Top Shapes



Square
p.164



Round
p.164



Rectangle
p.165

Exclaim Top Options

QG Quick-Connect Ganging Brackets can be added to any table for \$45 (includes 4 connectors per table).

RC 3" Radius Corners can be added to any table for \$61.

GR Grommets can be added to any table for \$45 each. To see specific locations, see page 227.

Exclaim Edge Options

(corresponds with 3 columns of pricing)

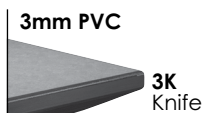
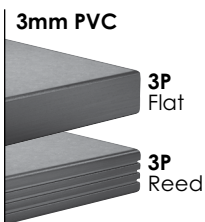

3 Heights Available

Lounge Height of 18" is available on square, round, and rectangular tables. These models are designated with a "-SH.18" in the model number and are listed on the next two pages.

Standard Height of 29" is shown on all standard models in the Exclaim line listed on pages 166-173. Custom heights outside of the three shown here are not available.

Standing Height of 42" is available on any standard Exclaim table. Simply add "-SH.42" to the model number and add \$53 per column to the list prices on pages 166-173.



SH.18 18" Lounge Height

18"H Square with 4 Columns	Top Size	Base	Model Number	3P	3K	3W
	24 x 24	Angled 2"	71SQ2424Q2-SH.18	\$ 932	\$ 979	\$ 1,067
	30 x 30	Angled 2"	71SQ3030Q2-SH.18	996	1,069	1,169
	36 x 36	Angled 2"	71SQ3636Q2-SH.18	1,074	1,179	1,287
	42 x 42	Angled 2"	71SQ4242Q2-SH.18	1,165	1,307	1,418
	48 x 48	Angled 2"	71SQ4848Q2-SH.18	1,271	1,454	1,565

18"H Round with 3 Columns	Top Size	Base	Model Number	3P	3K	3W
	24 x 24	Angled 2"	71RD24Q2(3)-SH.18	\$ 785	\$ 849	\$ 898

18"H Round with 4 Columns	Top Size	Base	Model Number	3P	3K	3W
	30 x 30	Angled 2"	71RD30Q2-SH.18	\$ 1,058	\$ 1,157	\$ 1,205
	36 x 36	Angled 2"	71RD36Q2-SH.18	1,150	1,286	1,331
	42 x 42	Angled 2"	71RD42Q2-SH.18	1,272	1,456	1,489
	48 x 48	Angled 2"	71RD48Q2-SH.18	1,307	1,505	1,551
	54 x 54	Angled 2"	71RD54Q2-SH.18	1,506	1,783	1,795
	60 x 60	Angled 2"	71RD60Q2-SH.18	1,533	1,822	1,850



For Exclaim table options, please reference pages 162-163.

SH.18 18" Lounge Height

Top Size	Base	Model Number	3P	3K	3W	18"H Rectangular with A Configuration
20 x 36	Angled 2"	71TC2036Q2.A-SH.18	\$ 989	\$ 1,059	\$ 1,151	
20 x 48	Angled 2"	71TC2048Q2.A-SH.18	1,046	1,140	1,246	
20 x 60	Angled 2"	71TC2060Q2.A-SH.18	1,073	1,178	1,307	
20 x 72	Angled 2"	71TC2072Q2.A-SH.18	1,122	1,247	1,392	
24 x 36	Angled 2"	71TC2436Q2.A-SH.18	989	1,059	1,162	
24 x 48	Angled 2"	71TC2448Q2.A-SH.18	1,046	1,140	1,255	
24 x 60	Angled 2"	71TC2460Q2.A-SH.18	1,073	1,178	1,316	
24 x 72	Angled 2"	71TC2472Q2.A-SH.18	1,122	1,247	1,402	
30 x 36	Angled 2"	71TC3036Q2.A-SH.18	1,031	1,119	1,224	
30 x 48	Angled 2"	71TC3048Q2.A-SH.18	1,102	1,218	1,333	
30 x 60	Angled 2"	71TC3060Q2.A-SH.18	1,124	1,249	1,389	
30 x 72	Angled 2"	71TC3072Q2.A-SH.18	1,180	1,328	1,481	
36 x 48	Angled 2"	71TC3648Q2.A-SH.18	1,159	1,297	1,411	
36 x 60	Angled 2"	71TC3660Q2.A-SH.18	1,244	1,416	1,535	
36 x 72	Angled 2"	71TC3672Q2.A-SH.18	1,296	1,490	1,625	

Top Size	Base	Model Number	3P	3K	3W	18"H Rectangular with V Configuration
24 x 36	Angled 2"	71TC2436Q2.V-SH.18	\$ 989	\$ 1,059	\$ 1,162	
24 x 48	Angled 2"	71TC2448Q2.V-SH.18	1,046	1,140	1,255	
24 x 60	Angled 2"	71TC2460Q2.V-SH.18	1,073	1,178	1,316	
24 x 72	Angled 2"	71TC2472Q2.V-SH.18	1,122	1,247	1,402	
30 x 36	Angled 2"	71TC3036Q2.V-SH.18	1,031	1,119	1,224	
30 x 48	Angled 2"	71TC3048Q2.V-SH.18	1,102	1,218	1,333	
30 x 60	Angled 2"	71TC3060Q2.V-SH.18	1,124	1,249	1,389	
30 x 72	Angled 2"	71TC3072Q2.V-SH.18	1,180	1,328	1,481	
36 x 48	Angled 2"	71TC3648Q2.V-SH.18	1,159	1,297	1,411	
36 x 60	Angled 2"	71TC3660Q2.V-SH.18	1,244	1,416	1,535	
36 x 72	Angled 2"	71TC3672Q2.V-SH.18	1,296	1,490	1,625	

For Exclaim table options, please reference pages 162-163.

Rectangular with X Configuration	Top Size	Base	Model Number	3P	3K	3W
 	20 x 36	Angled 2"	71TC2036Q2.X	\$ 989	\$ 1,059	\$ 1,151
	20 x 48	Angled 2"	71TC2048Q2.X	1,046	1,140	1,246
	20 x 60	Angled 2"	71TC2060Q2.X	1,073	1,178	1,307
	20 x 72	Angled 2"	71TC2072Q2.X	1,210	1,335	1,481
	20 x 84	Angled 2"	71TC2084Q2.X	1,307	1,469	1,617
	20 x 90	Angled 2"	71TC2090Q2.X	1,363	1,550	1,695
	20 x 96 *	Angled 2"	71TC2096Q2.X	1,363	1,550	1,711
	24 x 36	Angled 2"	71TC2436Q2.X	989	1,059	1,162
	24 x 48	Angled 2"	71TC2448Q2.X	1,046	1,140	1,255
	24 x 60	Angled 2"	71TC2460Q2.X	1,073	1,178	1,316
	24 x 72	Angled 2"	71TC2472Q2.X	1,210	1,335	1,490
	24 x 84	Angled 2"	71TC2484Q2.X	1,307	1,469	1,627
	24 x 90	Angled 2"	71TC2490Q2.X	1,363	1,550	1,706
	24 x 96 *	Angled 2"	71TC2496Q2.X	1,363	1,550	1,720
	30 x 36	Angled 2"	71TC3036Q2.X	1,031	1,119	1,224
	30 x 48	Angled 2"	71TC3048Q2.X	1,102	1,218	1,333
	30 x 60	Angled 2"	71TC3060Q2.X	1,124	1,249	1,389
	30 x 72	Angled 2"	71TC3072Q2.X	1,180	1,328	1,481
	30 x 84	Angled 2"	71TC3084Q2.X	1,403	1,605	1,750
	30 x 90	Angled 2"	71TC3090Q2.X	1,475	1,706	1,843
30 x 96 *	Angled 2"	71TC3096Q2.X	1,475	1,706	1,859	

Rectangular with V Configuration	Top Size	Base	Model Number	3P	3K	3W
 	36 x 48	Angled 2"	71TC3648Q2.V	\$ 1,159	\$ 1,297	\$ 1,411
	36 x 60	Angled 2"	71TC3660Q2.V	1,244	1,416	1,535
	36 x 72	Angled 2"	71TC3672Q2.V	1,296	1,490	1,625
	36 x 84	Angled 2"	71TC3684Q2.V	1,502	1,741	1,872
	36 x 90	Angled 2"	71TC3690Q2.V	1,585	1,859	1,980
	36 x 96 *	Angled 2"	71TC3696Q2.V	1,585	1,859	1,995
	42 x 60	Angled 3"	71TC4260Q3.V	1,343	1,546	1,658
	42 x 72	Angled 3"	71TC4272Q3.V	1,444	1,687	1,800
	42 x 84	Angled 3"	71TC4284Q3.V	1,629	1,911	2,026
	42 x 90	Angled 3"	71TC4290Q3.V	1,725	2,043	2,146
	42 x 96 *	Angled 3"	71TC4296Q3.V	1,725	2,043	2,160
	48 x 60	Angled 3"	71TC4860Q3.V	1,371	1,584	1,705
	48 x 72	Angled 3"	71TC4872Q3.V	1,531	1,809	1,911
	48 x 84	Angled 3"	71TC4884Q3.V	1,629	1,911	2,042
	48 x 90	Angled 3"	71TC4890Q3.V	1,726	2,045	2,163
	48 x 96 *	Angled 3"	71TC4896Q3.V	1,726	2,045	2,178

* \$200 NET surcharge per order for oversized pallet

For Exclaim table options, please reference pages 162-163.

Top Size	Base	Model Number	3P	3K	3W	Rectangular with V6 Configuration
42 x 120	Angled 3"	71TC42120Q3.V6	\$2,586	\$3,058	\$3,123	
42 x 144	Angled 3"	71TC42144Q3.V6	2,779	3,330	3,399	
48 x 120	Angled 3"	71TC48120Q3.V6	2,596	3,075	3,152	
48 x 144	Angled 3"	71TC48144Q3.V6	2,792	3,349	3,430	

Top Size	Base	Model Number	3P	3K	3W	Rectangular with A Configuration
42 x 60	Angled 3"	71TC4260Q3.A	\$1,343	\$1,546	\$1,658	
42 x 72	Angled 3"	71TC4272Q3.A	1,444	1,687	1,800	
42 x 84	Angled 3"	71TC4284Q3.A	1,629	1,911	2,026	
42 x 90	Angled 3"	71TC4290Q3.A	1,725	2,043	2,146	
42 x 96 *	Angled 3"	71TC4296Q3.A	1,725	2,043	2,160	
48 x 60	Angled 3"	71TC4860Q3.A	1,371	1,584	1,705	
48 x 72	Angled 3"	71TC4872Q3.A	1,531	1,809	1,911	
48 x 84	Angled 3"	71TC4884Q3.A	1,629	1,911	2,042	
48 x 90	Angled 3"	71TC4890Q3.A	1,726	2,045	2,163	
48 x 96 *	Angled 3"	71TC4896Q3.A	1,726	2,045	2,178	

Top Size	Base	Model Number	3P	3K	3W	Rectangular with A6 Configuration
42 x 120	Angled 3"	71TC42120Q3.A6	\$2,586	\$3,058	\$3,123	
42 x 144	Angled 3"	71TC42144Q3.A6	2,779	3,330	3,399	
48 x 120	Angled 3"	71TC48120Q3.A6	2,596	3,075	3,152	
48 x 144	Angled 3"	71TC48144Q3.A6	2,792	3,349	3,430	

* \$200 NET surcharge per order for oversized pallet

For Exclaim table options, please reference pages 162-163.

exclaim

Boat-shaped with V Configuration	Top Size	Base	Model Number	3P	3K	3W
	30 x 42 x 84	Angled 3"	71BT3084Q3.V	\$ 1,881	\$2,263	\$2,257
	30 x 42 x 90	Angled 3"	71BT3090Q3.V	2,016	2,453	2,421
	30 x 42 x 96 *	Angled 3"	71BT3096Q3.V	2,016	2,453	2,436
	36 x 48 x 84	Angled 3"	71BT3684Q3.V	2,015	2,451	2,413
	36 x 48 x 90	Angled 3"	71BT3690Q3.V	2,170	2,666	2,597
	36 x 48 x 96 *	Angled 3"	71BT3696Q3.V	2,170	2,666	2,614

Boat-shaped with V6 Configuration	Top Size	Base	Model Number	3P	3K	3W
	36 x 48 x 120	Angled 3"	71BT36120Q3.V6	\$ 3,144	\$3,841	\$3,700
	36 x 48 x 144	Angled 3"	71BT36144Q3.V6	3,452	4,272	4,101

Boat-shaped with A Configuration	Top Size	Base	Model Number	3P	3K	3W
	36 x 48 x 84	Angled 3"	71BT3684Q3.A	\$ 2,015	\$2,451	\$ 2,413
	36 x 48 x 90	Angled 3"	71BT3690Q3.A	2,170	2,666	2,597
	36 x 48 x 96 *	Angled 3"	71BT3696Q3.A	2,170	2,666	2,614

Boat-shaped with A6 Configuration	Top Size	Base	Model Number	3P	3K	3W
	36 x 48 x 120	Angled 3"	71BT36120Q3.A6	\$ 3,144	\$3,841	\$3,700
	36 x 48 x 144	Angled 3"	71BT36144Q3.A6	3,452	4,272	4,101

* \$200 NET surcharge per order for oversized pallet

For Exclaim table options, please reference pages 162-163.

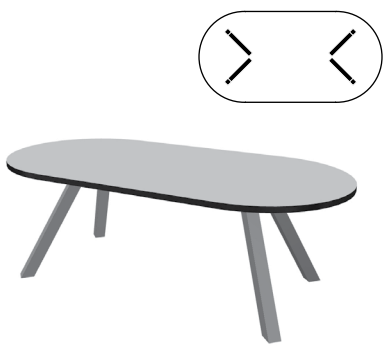
Top Size	Base	Model Number	3P	3K	3W	Racetrack with V Configuration
36 x 60	Angled 2"	71RT3660Q2.V	\$ 1,516	\$ 1,798	\$ 1,796	
36 x 72	Angled 2"	71RT3672Q2.V	1,516	1,798	1,826	
36 x 84	Angled 2"	71RT3684Q2.V	1,851	2,233	2,217	
36 x 90	Angled 2"	71RT3690Q2.V	1,990	2,426	2,386	
36 x 96 *	Angled 2"	71RT3696Q2.V	1,990	2,426	2,401	
42 x 84	Angled 3"	71RT4284Q3.V	1,879	2,259	2,254	
42 x 90	Angled 3"	71RT4290Q3.V	2,016	2,453	2,421	
42 x 96 *	Angled 3"	71RT4296Q3.V	2,016	2,453	2,436	
48 x 84	Angled 3"	71RT4884Q3.V	2,170	2,666	2,582	
48 x 90	Angled 3"	71RT4890Q3.V	2,170	2,666	2,597	
48 x 96 *	Angled 3"	71RT4896Q3.V	2,170	2,666	2,614	

Top Size	Base	Model Number	3P	3K	3W	Racetrack with V6 Configuration
42 x 120	Angled 3"	71RT42120Q3.V6	\$ 3,126	\$ 3,818	\$ 3,672	
42 x 144	Angled 3"	71RT42144Q3.V6	3,432	4,245	4,070	
48 x 120	Angled 3"	71RT48120Q3.V6	3,144	3,842	3,701	
48 x 144	Angled 3"	71RT48144Q3.V6	3,453	4,273	4,102	



Top Size	Base	Model Number	3P	3K	3W	Racetrack with A Configuration
42 x 84	Angled 3"	71RT4284Q3.A	\$ 1,879	\$ 2,259	\$ 2,254	
42 x 90	Angled 3"	71RT4290Q3.A	2,016	2,453	2,421	
42 x 96 *	Angled 3"	71RT4296Q3.A	2,016	2,453	2,436	
48 x 84	Angled 3"	71RT4884Q3.A	2,170	2,666	2,582	
48 x 90	Angled 3"	71RT4890Q3.A	2,170	2,666	2,597	
48 x 96 *	Angled 3"	71RT4896Q3.A	2,170	2,666	2,614	



Top Size	Base	Model Number	3P	3K	3W	Racetrack with A6 Configuration
42 x 120	Angled 3"	71RT42120Q3.A6	\$ 3,126	\$ 3,818	\$ 3,672	
42 x 144	Angled 3"	71RT42144Q3.A6	3,432	4,245	4,070	
48 x 120	Angled 3"	71RT48120Q3.A6	3,144	3,842	3,701	
48 x 144	Angled 3"	71RT48144Q3.A6	3,453	4,273	4,102	

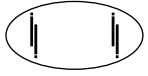

* \$200 NET surcharge per order for oversized pallet

For Exclaim table options, please reference pages 162-163.

exclaim

Elliptical with X Configuration	Top Size	Base	Model Number	3P	3K	3W
	30 x 54	Angled 2"	71EL3054Q2.X	\$ 1,256	\$ 1,434	\$ 1,472
	30 x 60	Angled 2"	71EL3060Q2.X	1,304	1,500	1,536
	36 x 60	Angled 2"	71EL3660Q2.X	1,403	1,640	1,658
	36 x 72	Angled 2"	71EL3672Q2.X	1,516	1,798	1,806
	36 x 84	Angled 2"	71EL3684Q2.X	1,724	2,053	2,049
	36 x 90	Angled 2"	71EL3690Q2.X	1,837	2,211	2,187
	36 x 96 *	Angled 2"	71EL3696Q2.X	1,837	2,211	2,198

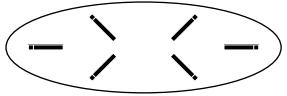
Elliptical with V Configuration	Top Size	Base	Model Number	3P	3K	3W
	42 x 72	Angled 3"	71EL4272Q3.V	\$ 1,662	\$ 1,991	\$ 1,976
	42 x 84	Angled 3"	71EL4284Q3.V	1,879	2,259	2,230
	42 x 90	Angled 3"	71EL4290Q3.V	2,019	2,456	2,397
	42 x 96 *	Angled 3"	71EL4296Q3.V	2,019	2,456	2,409
	48 x 72	Angled 3"	71EL4872Q3.V	1,775	2,149	2,112
	48 x 84	Angled 3"	71EL4884Q3.V	2,170	2,667	2,564
	48 x 90	Angled 3"	71EL4890Q3.V	2,170	2,667	2,575
	48 x 96 *	Angled 3"	71EL4896Q3.V	2,170	2,667	2,588

Elliptical with V6 Configuration	Top Size	Base	Model Number	3P	3K	3W
	42 x 120	Angled 3"	71EL42120Q3.V6	\$ 3,126	\$ 3,818	\$ 3,629
	42 x 144	Angled 3"	71EL42144Q3.V6	3,432	4,245	4,014
	48 x 120	Angled 3"	71EL48120Q3.V6	3,144	3,842	3,660
	48 x 144	Angled 3"	71EL48144Q3.V6	3,453	4,273	4,048

* \$200 NET surcharge per order for oversized pallet

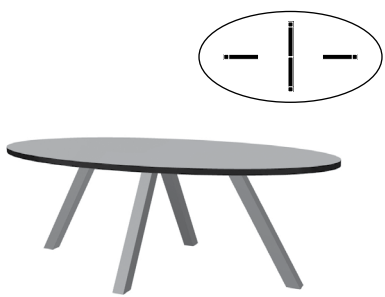

For Exclaim table options, please reference pages 162-163.

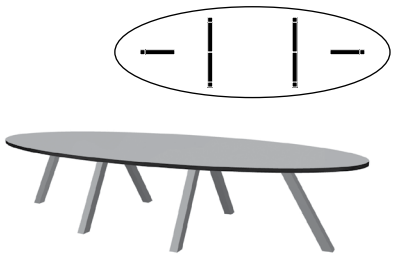

Top Size	Base	Model Number	3P	3K	3W	Elliptical with A Configuration
42 x 72	Angled 3"	71EL4272Q3.A	\$1,662	\$1,991	\$1,976	
42 x 84	Angled 3"	71EL4284Q3.A	1,879	2,259	2,230	
42 x 90	Angled 3"	71EL4290Q3.A	2,019	2,456	2,397	
42 x 96 *	Angled 3"	71EL4296Q3.A	2,019	2,456	2,409	
48 x 72	Angled 3"	71EL4872Q3.A	1,775	2,149	2,112	
48 x 84	Angled 3"	71EL4884Q3.A	2,170	2,667	2,564	
48 x 90	Angled 3"	71EL4890Q3.A	2,170	2,667	2,575	
48 x 96 *	Angled 3"	71EL4896Q3.A	2,170	2,667	2,588	

Top Size	Base	Model Number	3P	3K	3W	Elliptical with A6 Configuration
42 x 120	Angled 3"	71EL42120Q3.A6	\$3,126	\$3,818	\$3,629	
42 x 144	Angled 3"	71EL42144Q3.A6	3,432	4,245	4,014	
48 x 120	Angled 3"	71EL48120Q3.A6	3,144	3,842	3,660	
48 x 144	Angled 3"	71EL48144Q3.A6	3,453	4,273	4,048	

* \$200 NET surcharge per order for oversized pallet

For Exclaim table options, please reference pages 162-163.

D-shaped with X Configuration	Top Size	Base	Model Number	3P	3K	3W
 	24 x 36	Angled 2"	71D2436Q2.X	\$ 1,046	\$ 1,140	\$ 1,211
	24 x 48	Angled 2"	71D2448Q2.X	1,123	1,249	1,329
	24 x 60	Angled 2"	71D2460Q2.X	1,202	1,358	1,445
	24 x 72	Angled 2"	71D2472Q2.X	1,279	1,467	1,562
	24 x 84	Angled 2"	71D2484Q2.X	1,212	1,337	1,510
	24 x 90	Angled 2"	71D2490Q2.X	1,486	1,719	1,826
	24 x 96 *	Angled 2"	71D2496Q2.X	1,525	1,775	1,885
	30 x 48	Angled 2"	71D3048Q2.X	1,202	1,358	1,426
	30 x 60	Angled 2"	71D3060Q2.X	1,299	1,495	1,565
	30 x 72	Angled 2"	71D3072Q2.X	1,397	1,631	1,704
	30 x 84	Angled 2"	71D3084Q2.X	1,583	1,857	1,930
	30 x 90	Angled 2"	71D3090Q2.X	1,632	1,925	2,000
	30 x 96 *	Angled 2"	71D3096Q2.X	1,682	1,993	2,069

D-shaped with V Configuration	Top Size	Base	Model Number	3P	3K	3W
 	36 x 48	Angled 2"	71D3648Q2.V	\$ 1,279	\$ 1,467	\$ 1,525
	36 x 60	Angled 2"	71D3660Q2.V	1,397	1,631	1,685
	36 x 72	Angled 2"	71D3672Q2.V	1,515	1,796	1,844
	36 x 84	Angled 2"	71D3684Q2.V	1,719	2,048	2,093
	36 x 90	Angled 2"	71D3690Q2.V	1,779	2,131	2,173
	36 x 96 *	Angled 2"	71D3696Q2.V	1,838	2,213	2,254
	42 x 60	Angled 3"	71D4260Q3.V	1,888	2,308	2,234
	42 x 72	Angled 3"	71D4272Q3.V	1,888	2,308	2,265
	42 x 84	Angled 3"	71D4284Q3.V	2,009	2,442	2,421
	42 x 90	Angled 3"	71D4290Q3.V	2,087	2,551	2,522
	42 x 96 *	Angled 3"	71D4296Q3.V	2,165	2,659	2,621
	48 x 60	Angled 3"	71D4860Q3.V	1,931	2,369	2,294
	48 x 72	Angled 3"	71D4872Q3.V	1,931	2,369	2,325
	48 x 84	Angled 3"	71D4884Q3.V	2,020	2,457	2,445
	48 x 90	Angled 3"	71D4890Q3.V	2,098	2,568	2,547
	48 x 96 *	Angled 3"	71D4896Q3.V	2,176	2,677	2,649
	54 x 54	Angled 3"	71D5454Q3.V	1,804	2,192	2,151
	60 x 60	Angled 3"	71D6060Q3.V	1,815	2,204	2,190

* \$200 NET surcharge per order for oversized pallet

For Exclaim table options, please reference pages 162-163.

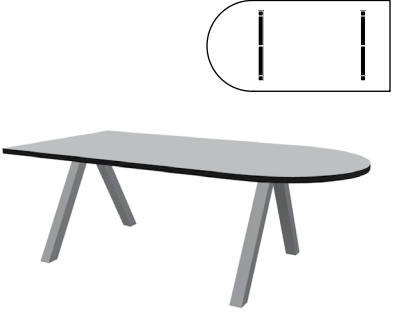
Top Size	Base	Model Number	3P	3K	3W	D-shaped with A Configuration
42 x 60	Angled 3"	71D4260Q3.A	\$1,888	\$2,308	\$2,234	
42 x 72	Angled 3"	71D4272Q3.A	1,888	2,308	2,265	
42 x 84	Angled 3"	71D4284Q3.A	2,009	2,442	2,421	
42 x 90	Angled 3"	71D4290Q3.A	2,087	2,551	2,522	
42 x 96 *	Angled 3"	71D4296Q3.A	2,165	2,659	2,621	
48 x 60	Angled 3"	71D4860Q3.A	1,931	2,369	2,294	
48 x 72	Angled 3"	71D4872Q3.A	1,931	2,369	2,325	
48 x 84	Angled 3"	71D4884Q3.A	2,020	2,457	2,445	
48 x 90	Angled 3"	71D4890Q3.A	2,098	2,568	2,547	
48 x 96 *	Angled 3"	71D4896Q3.A	2,176	2,677	2,649	
54 x 54	Angled 3"	71D5454Q3.A	1,804	2,192	2,151	
60 x 60	Angled 3"	71D6060Q3.A	1,815	2,204	2,190	

Top Size	Base	Model Number	3P	3K	3W	Square with 4 Columns
36 x 36	Angled 2"	71SQ3636Q2	\$1,074	\$1,179	\$1,287	
42 x 42	Angled 2"	71SQ4242Q2	1,165	1,307	1,418	
	Angled 3"	71SQ4242Q3	1,191	1,333	1,445	
48 x 48	Angled 2"	71SQ4848Q2	1,271	1,454	1,565	
	Angled 3"	71SQ4848Q3	1,297	1,481	1,592	
54 x 54	Angled 3"	71SQ5454Q3	1,417	1,648	1,754	
60 x 60	Angled 3"	71SQ6060Q3	1,549	1,834	1,931	

Top Size	Base	Model Number	3P	3K	3W	Round with 3 Columns
42 x 42	Angled 2"	71RD42Q2(3)	\$1,086	\$1,271	\$1,304	
48 x 48	Angled 3"	71RD48Q3(3)	1,140	1,338	1,385	

Top Size	Base	Model Number	3P	3K	3W	Round with 4 Columns
48 x 48	Angled 2"	71RD48Q2	\$1,307	\$1,505	\$1,551	
54 x 54	Angled 3"	71RD54Q3	1,532	1,811	1,821	
60 x 60	Angled 3"	71RD60Q3	1,560	1,848	1,877	

* \$200 NET surcharge per order for oversized pallet

For Exclaim table options, please reference pages 162-163.

exclaim



table~~x~~

74 vertiGo
price list
Effective January 1, 2023

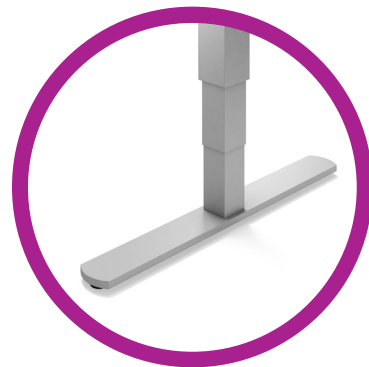



Adjusting one's work surface height has become the most personal and impactful detail within a workspace. VertiGo is designed to go from sit-to-stand, and any height in between, with ease. Match with static or nesting tables for a cohesive look throughout a space.

VertiGo Base Styles

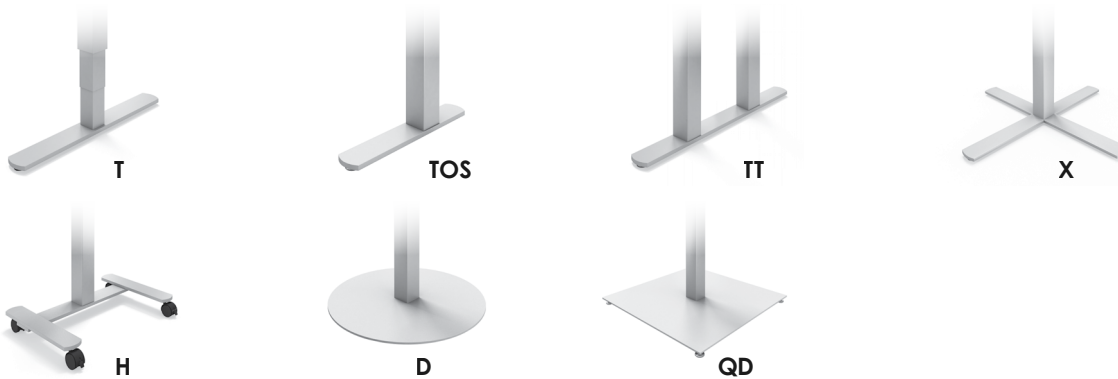

VertiGo Options

Standard Glides



Locking Casters

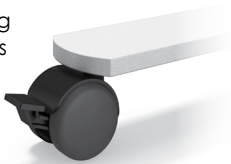

- LC Locking Casters**
can be added to any table for \$111 per set of four.
- FD Folding Bases**
are not available on VertiGo tables.
- NE Nesting Tables**
priced accordingly with locking casters.
- FT Flip Tops**
available on X-based and H-based tables for \$138. Not available on counterbalanced tables.

- WM Wire Management**
Built-in wire management is not available on VertiGo tables.
- MMLC Magnetic Wire Management Leg Covers**
Magnetically attaches onto any square leg and are \$71 each.
- OS Offset T-bases**
available for \$39 per table. Offset is not available on 18"d tables or 30"d nesting tables less than 60" wide.

- SH Special Height**
can be added to any table:
+ \$72 per column for heights > 29"
+ \$39 per column for heights < 29"
Special height tables with tops larger than 36x72" must be custom quoted.
- FR Footring**
is not available on VertiGo tables.
- CH Chrome Finish**
is not available on VertiGo tables.

VertiGo Height Adjustable Options

RA Ratchet
NE RA is available on T-bases and nesting for \$507 list per table. Available height adjustable finishes can be found on page 9.

CR Hand Crank
NE CR is available on most T-, X-, and L-bases and some nesting models as listed. Available height adjustable finishes can be found on page 9.

BL Counterbalanced and Short Balanced
BLS are available on disc and X-bases. Available height adjustable finishes can be found on page 9.

EH Electric Height is available on T- and TT-bases and are available in two finishes:

- 37 Satin Silver
- 57 Jet

Two-leg counterbalanced units are only available in three finishes:

- 30 Pearl
- 37 Satin Silver
- 57 Jet

VertiGo Top Shapes



Rectangle
p.180, 187



Boat
p.184



Racetrack
p.185

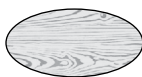

Elliptical
p.186



Kidney Bean
p.187



Square
p.188



Round
p.189



D-shaped
p.190



Half Round
p.192



Trapezoid
p.193



Squirecle
p.193

VertiGo Top Options

QG Quick-Connect Ganging Brackets can be added to any table for \$45 (includes 4 connectors per table).

RC 3" Radius Corners can be added to any table for \$61.

GR Grommets can be added to any table for \$45 each. To see specific locations, see page 227.

VertiGo Edge Options

(corresponds with 3 columns of pricing)

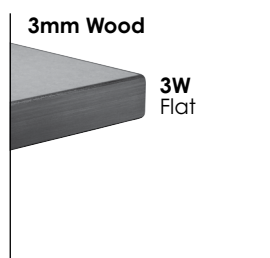
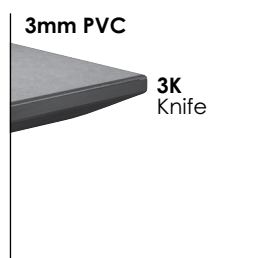
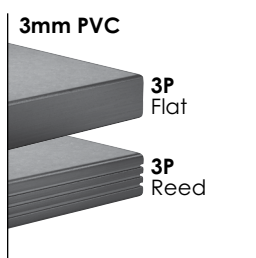

Ratchet Height Adjustability

Ratchet height adjustability is available on most tables in the VertiGo line... T-bases, X-bases, and even disc bases. Simply lift the top near the base's mounting plate, and the ratchet clicks into place. With a range of 9.45" the ratchet works in thirteen increments of .78". To reset to the lowest position just lift past its highest point.

will be adjusted to ensure that the range of mobile tables is consistent with that of static tables.

To specify:
All available ratchet models are priced in the following pages. They are denoted by the "RA" at the end of the model number.

Example:
74TC2060T18RA-3P
20x60" **ratchet** table
\$1,375 List Price

Want to use VertiGo on the go? Casters can be added, and the height of the base

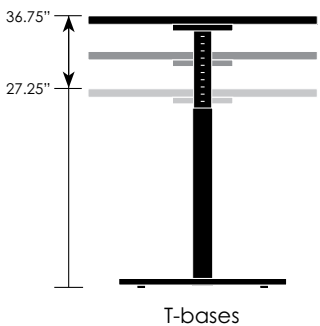
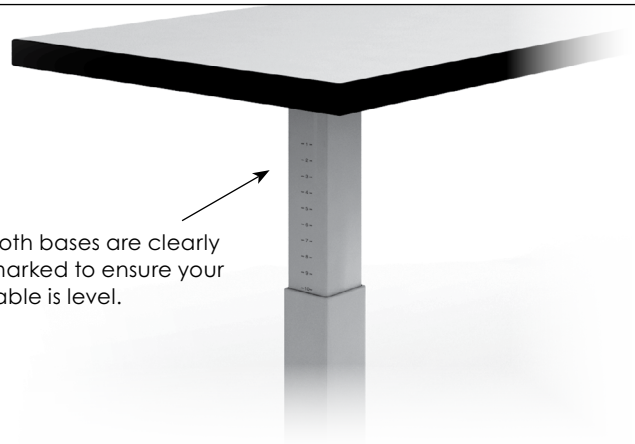

T-bases



X-bases
Disc Bases
H-bases

Nesting Ratchet

Ratchet height adjustability is also available on many of the nesting T-base models in the VertiGo line. All available nesting models are denoted by the "NE" at the end of the model number. To add the ratchet option to those models, change the "NE" to "NERA" and add \$507 to the list price.

Example:
74TC2060T18NERA-3P
20x60" **nesting ratchet** table
\$1,548 + 507 = \$2,055 List Price

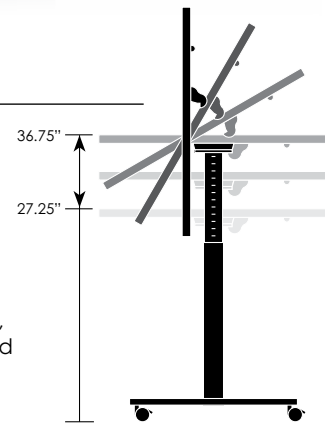

vertiGo

Manual Hand Crank Height Adjustability

Need the flexibility of infinite adjustability without the budget for counterbalanced bases? Our manual hand crank offers a cost-effective alternative.

"CR" at the end of the model number.

Example:
74TC2060T18CR-3P
20x60" **hand crank** table
\$1,548 List Price

To specify:
All available hand crank models are priced in the following pages. They are denoted by the

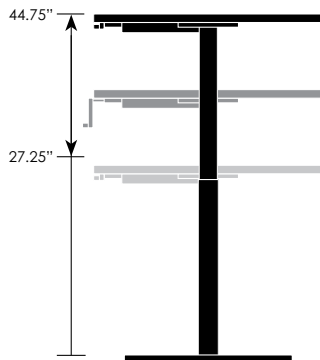
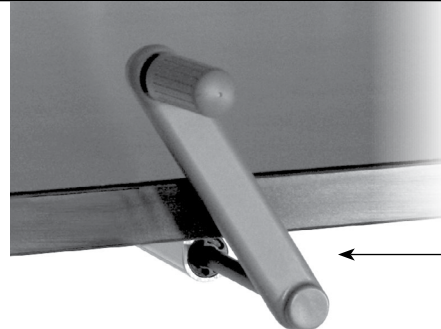

Crank Bases

Nesting Hand Crank

Introducing hand crank height adjustable tables that nest! Only available on rectangular tables 20x60" to 36-72". These models are denoted by the "NECR" at the end of the model number.

Example:
74TC2060T18NECR-3P
20x60" **nesting hand crank** table
\$2,054 List Price



Electric Height Adjustability

Electric height adjustability gives you the ability to adjust tables at the push of a button. The standard memory keypad will remember your four favorite heights. Available on both VertiGo T and TT-bases, this option works great in private offices or even in conference rooms.

To specify:
All available electric models are priced in the following pages. They are denoted by the "EH" at the end of the model number.

Example:
74TC2060T18EH-3P
20x60" **electric height** table
\$2,682 List Price

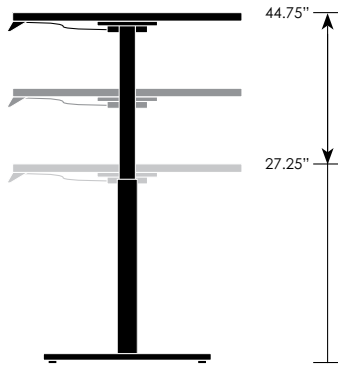

Electric T-bases

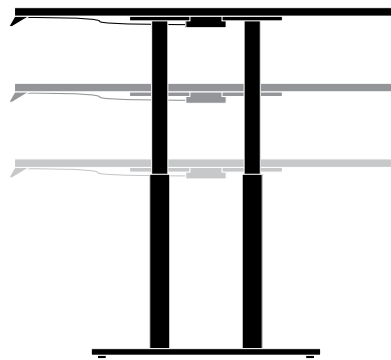

Electric TT-bases

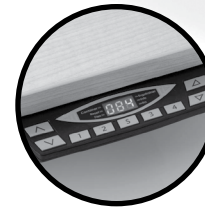
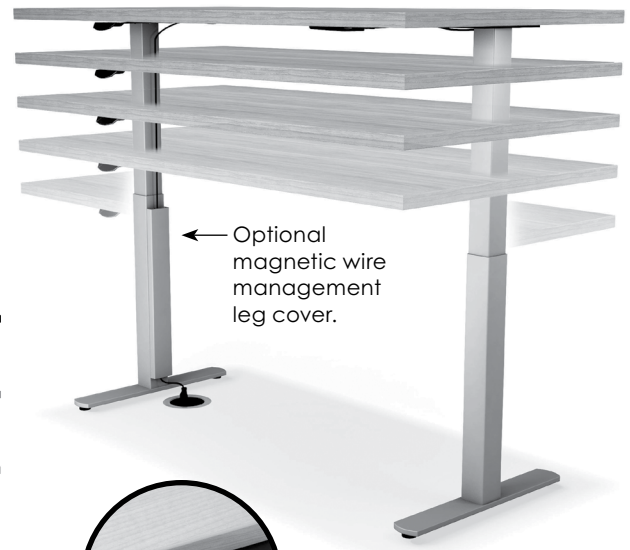

Retractable Memory Keypad

Counterbalanced & Short Balanced Height Adjustability

Counterbalanced tables go from seated-to-standing height, while the short balanced goes from coffee-to-seated height. Available on tables using single column disc or X-bases, these tables are easy to adjust. Simply squeeze the small handle underneath and gently move the top to your desired height. It's that easy.

Want to use VertiGo on the go? Simply add 2" to each vertical measurement to account for the added height of locking casters.

To specify:
All available counterbalanced models are priced in the following pages. They are denoted by the "BL" or "BLS" (for short balanced) at the end of the model number.



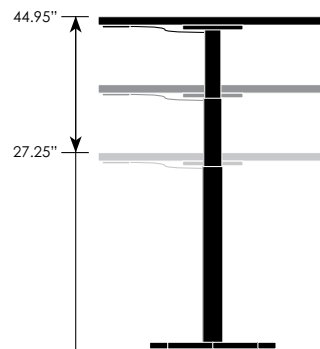
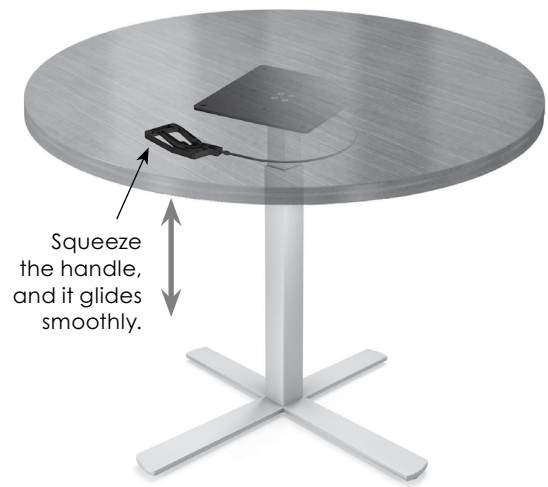

Example:
74RD36X32BL-3P
36" round **counterbalanced** table
\$1,507 List Price

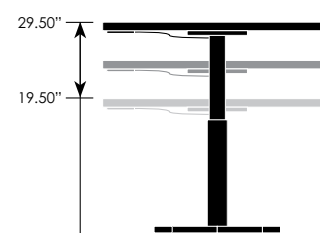

BL Counterbalanced disc or X-bases

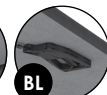

BLS Short balanced disc or X-bases

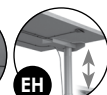
Rectangular with T-bases	Top Size	Base	Model Number	3P	3K	3W
      	20 x 36	Static	74TC2036T18	\$ 733	\$ 805	\$ 896
		Nesting	74TC2036T18NE	1,425	1,496	1,585
		Ratchet	74TC2036T18RA	1,291	1,362	1,454
		Crank	74TC2036T18CR	1,464	1,535	1,626
		Electric	74TC2036T18EH	2,598	2,669	2,761
	20 x 48	Static	74TC2048T18	791	886	991
		Nesting	74TC2048T18NE	1,483	1,574	1,678
		Ratchet	74TC2048T18RA	1,349	1,443	1,548
		Crank	74TC2048T18CR	1,521	1,615	1,720
		Count Bal	74TC2048T18BL	2,643	2,738	2,843
		Electric	74TC2048T18EH	2,656	2,749	2,855
	20 x 60	Static	74TC2060T18	818	921	1,050
		Nesting	74TC2060T18NE	1,508	1,610	1,737
		Ratchet	74TC2060T18RA	1,375	1,480	1,608
		Crank	74TC2060T18CR	1,548	1,652	1,781
Nest/Crank		74TC2060T18NECR	2,154	2,257	2,384	
Count Bal		74TC2060T18BL	2,722	2,827	2,955	
Electric		74TC2060T18EH	2,682	2,787	2,916	
20 x 72	Static	74TC2072T18	868	991	1,137	
	Nesting	74TC2072T18NE	1,792	1,914	2,056	
	Ratchet	74TC2072T18RA	1,514	1,637	1,782	
	Crank	74TC2072T18CR	1,686	1,811	1,955	
	Nest/Crank	74TC2072T18NECR	2,245	2,367	2,509	
	Count Bal	74TC2072T18BL	2,863	2,988	3,134	
	Electric	74TC2072T18EH	2,820	2,945	3,090	
20 x 84	Static	74TC2084T18	1,052	1,215	1,361	
	Nesting	74TC2084T18NE	1,886	2,046	2,191	
	Electric	74TC2084T18EH	2,916	3,079	3,227	
20 x 90	Static	74TC2090T18	1,109	1,294	1,441	
	Nesting	74TC2090T18NE	1,943	2,125	2,267	
	Electric	74TC2090T18EH	2,973	3,160	3,305	
20 x 96 *	Static	74TC2096T18	1,109	1,294	1,456	
	Nesting	74TC2096T18NE	1,943	2,125	2,283	
	Electric	74TC2096T18EH	2,973	3,160	3,321	
24 x 36	Static	74TC2436T22	753	825	927	
	Nesting	74TC2436T22NE	1,445	1,515	1,615	
	Ratchet	74TC2436T22RA	1,311	1,382	1,484	
	Crank	74TC2436T22CR	1,480	1,551	1,653	
	Electric	74TC2436T22EH	2,615	2,685	2,788	
24 x 48	Static	74TC2448T22	810	905	1,021	
	Nesting	74TC2448T22NE	1,502	1,594	1,708	
	Ratchet	74TC2448T22RA	1,368	1,463	1,579	
	Crank	74TC2448T22CR	1,538	1,631	1,748	
	Count Bal	74TC2448T22BL	2,659	2,753	2,869	
	Electric	74TC2448T22EH	2,673	2,766	2,882	

* \$200 NET surcharge per order for oversized pallet

For VertiGo table options, please reference pages 176-177.

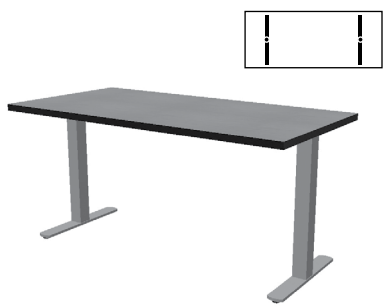
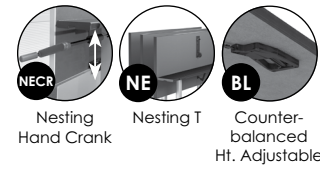
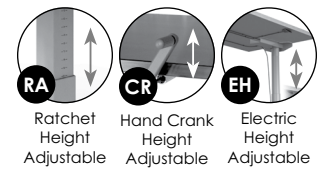
Top Size	Base	Model Number	3P	3K	3W	Rectangular with T-bases
24 x 60	Static	74TC2460T22	\$ 837	\$ 941	\$ 1,081	
	Nesting	74TC2460T22NE	1,528	1,630	1,768	
	Ratchet	74TC2460T22RA	1,396	1,499	1,640	
	Crank	74TC2460T22CR	1,564	1,668	1,808	
	Nest/Crank	74TC2460T22NECR	2,172	2,275	2,411	
	Count Bal	74TC2460T22BL	2,741	2,844	2,985	
	Electric	74TC2460T22EH	2,699	2,804	2,943	
	Battery/Nest	74TC2460T22BEHNE	3,822	3,927	4,066	
24 x 72	Static	74TC2472T22	888	1,011	1,166	
	Nesting	74TC2472T22NE	1,812	1,934	2,086	
	Ratchet	74TC2472T22RA	1,444	1,569	1,725	
	Crank	74TC2472T22CR	1,614	1,737	1,893	
	Nest/Crank	74TC2472T22NECR	2,263	2,386	2,538	
	Count Bal	74TC2472T22BL	2,793	2,917	3,074	
	Electric	74TC2472T22EH	2,748	2,873	3,029	
	Battery/Nest	74TC2472T22BEHNE	4,111	4,236	4,392	
24 x 84	Static	74TC2484T22	1,071	1,234	1,393	
	Nesting	74TC2484T22NE	1,905	2,065	2,220	
	Electric	74TC2484T22EH	2,932	3,096	3,253	
24 x 90	Static	74TC2490T22	1,129	1,314	1,470	
	Nesting	74TC2490T22NE	1,961	2,145	2,298	
	Electric	74TC2490T22EH	2,990	3,176	3,332	
24 x 96 *	Static	74TC2496T22	1,129	1,314	1,486	
	Nesting	74TC2496T22NE	1,961	2,145	2,312	
	Electric	74TC2496T22EH	2,990	3,176	3,347	
30 x 36	Static	74TC3036T26	815	903	1,008	
	Nesting	74TC3036T26NE	1,507	1,593	1,695	
	Ratchet	74TC3036T26RA	1,375	1,463	1,568	
	Crank	74TC3036T26CR	1,541	1,628	1,734	
	Electric	74TC3036T26EH	2,677	2,765	2,871	
30 x 48	Static	74TC3048T26	888	1,003	1,118	
	Nesting	74TC3048T26NE	1,577	1,690	1,803	
	Ratchet	74TC3048T26RA	1,445	1,562	1,676	
	Crank	74TC3048T26CR	1,612	1,729	1,843	
	Count Bal	74TC3048T26BL	2,732	2,848	2,963	
	Electric	74TC3048T26EH	2,748	2,864	2,980	
30 x 60	Static	74TC3060T26	910	1,034	1,174	
	Nesting	74TC3060T26NE	1,599	1,720	1,858	
	Ratchet	74TC3060T26RA	1,467	1,593	1,732	
	Crank	74TC3060T26CR	1,634	1,759	1,899	
	Nest/Crank	74TC3060T26NECR	2,239	2,363	2,499	
	Count Bal	74TC3060T26BL	2,764	2,889	3,029	
	Electric	74TC3060T26EH	2,770	2,896	3,035	
	Battery/Nest	74TC3060T26BEHNE	3,892	4,018	4,156	

* \$200 NET surcharge per order for oversized pallet

For VertiGo table options, please reference pages 176-177.

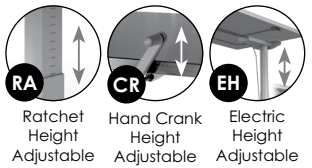
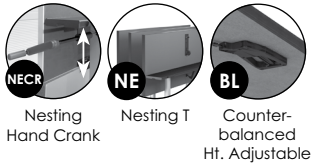

Rectangular with T-bases	Top Size	Base	Model Number	3P	3K	3W	
	30 x 72	Static	74TC3072T26	\$ 964	\$1,112	\$1,266	
		Nesting	74TC3072T26NE	1,887	2,032	2,182	
		Ratchet	74TC3072T26RA	1,524	1,671	1,824	
		Crank	74TC3072T26CR	1,690	1,837	1,991	
		Nest/Crank	74TC3072T26NECR	2,336	2,481	2,632	
		Count Bal	74TC3072T26BL	2,866	3,013	3,167	
		Electric	74TC3072T26EH	2,826	2,973	3,127	
		Battery/Nest	74TC3072T26BEHNE	4,187	4,335	4,488	
		30 x 84	Static	74TC3084T26	1,188	1,390	1,535
			Nesting	74TC3084T26NE	2,021	2,218	2,359
Electric	74TC3084T26EH		3,050	3,251	3,395		
30 x 90	Static	74TC3090T26	1,260	1,490	1,628		
	Electric	74TC3090T26EH	3,121	3,351	3,490		
30 x 96 *	Static	74TC3096T26	1,260	1,490	1,644		
	Electric	74TC3096T26EH	3,121	3,351	3,504		
36 x 48	Static	74TC3648T26	943	1,081	1,195		
	Nesting	74TC3648T26NE	1,763	1,900	2,011		
	Ratchet	74TC3648T26RA	1,502	1,641	1,754		
	Crank	74TC3648T26CR	1,668	1,806	1,921		
	Count Bal	74TC3648T26BL	2,788	2,927	3,040		
	Electric	74TC3648T26EH	2,805	2,944	3,057		
36 x 60	Static	74TC3660T26	1,027	1,201	1,319		
	Nesting	74TC3660T26NE	1,923	2,091	2,210		
	Ratchet	74TC3660T26RA	1,586	1,759	1,879		
	Crank	74TC3660T26CR	1,753	1,926	2,045		
	Nest/Crank	74TC3660T26NECR	2,398	2,568	2,684		
	Count Bal	74TC3660T26BL	2,883	3,055	3,175		
	Electric	74TC3660T26EH	2,889	3,061	3,182		
	Battery/Nest	74TC3660T26BEHNE	4,223	4,396	4,514		
36 x 72	Static	74TC3672T26	1,081	1,275	1,410		
	Nesting	74TC3672T26NE	2,002	2,193	2,324		
	Ratchet	74TC3672T26RA	1,641	1,835	1,969		
	Crank	74TC3672T26CR	1,806	2,001	2,134		
	Nest/Crank	74TC3672T26NECR	2,451	2,641	2,772		
	Count Bal	74TC3672T26BL	2,982	3,178	3,311		
	Electric	74TC3672T26EH	2,943	3,137	3,271		
	Battery/Nest	74TC3672T26BEHNE	4,304	4,498	4,633		
	36 x 84	Static	74TC3684T26	1,287	1,527	1,657	
Electric		74TC3684T26EH	3,147	3,388	3,518		
36 x 90	Static	74TC3690T26	1,371	1,644	1,764		
	Electric	74TC3690T26EH	3,231	3,504	3,626		
36 x 96 *	Static	74TC3696T26	1,371	1,644	1,780		
	Electric	74TC3696T26EH	3,231	3,504	3,642		



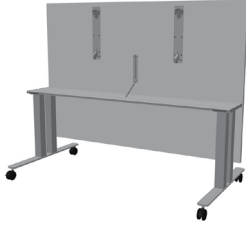

vertiGo

* \$200 NET surcharge per order for oversized pallet

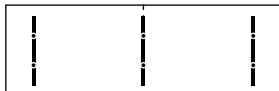

For VertiGo table options, please reference pages 176-177.

Top Size	Base	Model Number	3P	3K	3W	Rectangular with TT-bases
42 x 60	Static	74TC4260TT32	\$1,886	\$2,089	\$2,201	    Nesting TT Electric Height Adjustable
	Nesting	74TC4260TT32NE	2,958	3,157	3,267	
	Electric	74TC4260TT32EH	5,402	5,604	5,717	
42 x 72	Static	74TC4272TT32	1,988	2,231	2,344	
	Nesting	74TC4272TT32NE	3,057	3,294	3,406	
	Electric	74TC4272TT32EH	5,502	5,745	5,858	
42 x 84	Static	74TC4284TT32	2,173	2,454	2,570	
	Electric	74TC4284TT32EH	5,687	5,970	6,084	
42 x 90	Static	74TC4290TT32	2,266	2,587	2,688	
	Electric	74TC4290TT32EH	5,783	6,101	6,204	
42 x 96 *	Static	74TC4296TT32	2,266	2,587	2,704	
	Electric	74TC4296TT32EH	5,783	6,101	6,219	
48 x 60	Static	74TC4860TT36	1,925	2,137	2,258	
	Nesting	74TC4860TT36NE	2,994	3,204	3,321	
	Electric	74TC4860TT36EH	7,814	8,027	8,146	
48 x 72	Static	74TC4872TT36	2,085	2,363	2,465	
	Nesting	74TC4872TT36NE	3,152	3,423	3,524	
	Electric	74TC4872TT36EH	7,974	8,251	8,354	
48 x 84	Static	74TC4884TT36	2,182	2,465	2,595	
	Electric	74TC4884TT36EH	8,073	8,353	8,484	
48 x 90	Static	74TC4890TT36	2,279	2,598	2,717	
	Electric	74TC4890TT36EH	8,168	8,487	8,605	
48 x 96 *	Static	74TC4896TT36	2,279	2,598	2,732	
	Electric	74TC4896TT36EH	8,168	8,487	8,620	

Top Size	Base	Model Number	3P	3K	3W	Rectangular with 3 TT-bases
42 x 120	Static	74TC42120TT32(3)	\$3,312	\$3,785	\$3,850	  
42 x 144	Static	74TC42144TT32(3)	3,505	4,057	4,126	
48 x 120	Static	74TC48120TT36(3)	3,338	3,817	3,894	
48 x 144	Static	74TC48144TT36(3)	3,535	4,091	4,172	

* \$200 NET surcharge per order for oversized pallet



For VertiGo table options, please reference pages 176-177.

Boat-shaped with T-bases	Top Size	Base	Model Number	3P	3K	3W
 	30 x 42 x 84	Static	74BT3084T26	\$ 1,640	\$2,022	\$ 2,015
		Electric	74BT3084T26EH	3,500	3,883	3,876
	30 x 42 x 90	Static	74BT3090T26	1,775	2,211	2,179
		Electric	74BT3090T26EH	3,636	4,072	4,041
	30 x 42 x 96 *	Static	74BT3096T26	1,775	2,211	2,195
		Electric	74BT3090T26EH	3,636	4,072	4,056

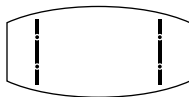
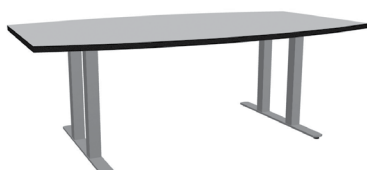



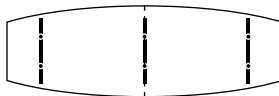





Boat-shaped with TT-bases	Top Size	Base	Model Number	3P	3K	3W
 	36 x 48 x 84	Static	74BT3684TT36	\$2,569	\$3,005	\$ 2,967
		Electric	74BT3684TT36EH	8,458	8,894	8,855
	36 x 48 x 90	Static	74BT3690TT36	2,723	3,220	3,152
		Electric	74BT3690TT36EH	8,613	9,110	9,040
	36 x 48 x 96 *	Static	74BT3696TT36	2,723	3,220	3,167
		Electric	74BT3696TT36EH	8,613	9,110	9,056



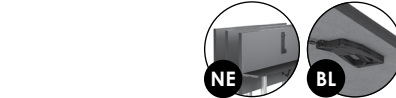



Boat-shaped with 3 TT-bases	Top Size	Base	Model Number	3P	3K	3W
 	36 x 48 x 120	Static	74BT36120TT36(3)	\$3,887	\$4,583	\$4,442
	36 x 48 x 144	Static	74BT36144TT36(3)	4,194	5,014	4,843
	 <p>3 bases: LC SH N/A quote</p>					



* \$200 NET surcharge per order for oversized pallet

For VertiGo table options, please reference pages 176-177.

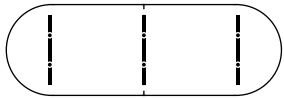
Top Size	Base	Model Number	3P	3K	3W	Racetrack with T-bases
36 x 60	Static	74RT3672T26	\$1,300	\$1,583	\$1,580	 
	Nesting	74RT3660T26NE	2,114	2,391	2,389	
	Ratchet	74RT3672T26RA	1,860	2,142	2,138	
	Crank	74RT3672T26CR	2,026	2,307	2,305	
	Count Bal	74RT3660T26BL	3,156	3,437	3,435	
	Electric	74RT3672T26EH	3,162	3,444	3,442	
36 x 72	Static	74RT3672T26	1,300	1,583	1,612	
	Nesting	74RT3672T26NE	2,191	2,467	2,495	
	Ratchet	74RT3672T26RA	1,860	2,142	2,170	
	Crank	74RT3672T26CR	2,026	2,307	2,336	
	Count Bal	74RT3672T26BL	3,203	3,483	3,513	
	Electric	74RT3672T26EH	3,162	3,444	3,473	
36 x 84	Static	74RT3684T26	1,636	2,018	2,002	 Nesting T  Counter-balanced Ht. Adjustable
	Electric	74RT3684T26EH	3,497	3,878	3,864	
36 x 90	Static	74RT3690T26	1,775	2,211	2,171	 Ratchet Height Adjustable  Hand Crank Height Adjustable  Electric Height Adjustable
	Electric	74RT3690T26EH	3,636	4,072	4,031	
36 x 96 *	Static	74RT3696T26	1,775	2,211	2,187	
	Electric	74RT3696T26EH	3,636	4,072	4,047	

Top Size	Base	Model Number	3P	3K	3W	Racetrack with TT-bases
42 x 84	Static	74RT4284TT32	\$2,421	\$2,803	\$2,796	
	Electric	74RT4284TT32EH	5,937	6,317	6,312	
42 x 90	Static	74RT4290TT32	2,560	2,996	2,965	
	Electric	74RT4290TT32EH	6,075	6,512	6,479	
42 x 96 *	Static	74RT4296TT32	2,560	2,996	2,980	
	Electric	74RT4296TT32EH	6,075	6,512	6,495	
48 x 84	Static	74RT4884TT36	2,723	3,220	3,136	
	Electric	74RT4884TT36EH	8,613	9,110	9,025	
48 x 90	Static	74RT4890TT36	2,723	3,220	3,152	 Electric Height Adjustable
	Electric	74RT4890TT36EH	8,613	9,110	9,040	
48 x 96 *	Static	74RT4896TT36	2,723	3,220	3,167	
	Electric	74RT4896TT36EH	8,613	9,110	9,056	

Top Size	Base	Model Number	3P	3K	3W	Racetrack with TT-bases
42 x 120	Static	74RT42120TT32(3)	\$3,853	\$4,545	\$4,399	 
42 x 144	Static	74RT42144TT32(3)	4,158	4,971	4,797	
48 x 120	Static	74RT48120TT36(3)	3,887	4,584	4,443	
48 x 144	Static	74RT48144TT36(3)	4,195	5,015	4,844	

 N/A
  quote
  3 bases:

* \$200 NET surcharge per order for oversized pallet

For VertiGo table options, please reference pages 176-177.

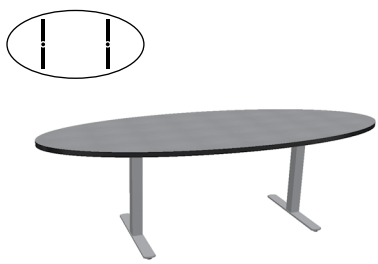
Elliptical with T-bases	Top Size	Base	Model Number	3P	3K	3W
	30 x 54	Static	74EL3054T22	\$ 1,021	\$ 1,200	\$ 1,237
		Ratchet	74EL3054T22RA	1,579	1,757	1,795
		Count Bal	74EL3054T22BL	2,874	3,053	3,137
		Electric	74EL3054T22EH	2,883	3,060	3,098
	30 x 60	Static	74EL3060T22	1,068	1,266	1,300
		Ratchet	74EL3060T22RA	1,626	1,823	1,859
		Count Bal	74EL3060T22BL	2,971	3,168	3,253
		Electric	74EL3060T22EH	2,929	3,126	3,162
	36 x 60	Static	74EL3660T26	1,187	1,424	1,442
		Ratchet	74EL3660T26RA	1,747	1,983	2,001
		Count Bal	74EL3660T26BL	3,042	3,279	3,350
		Electric	74EL3660T26EH	3,050	3,285	3,304
36 x 72	Static	74EL3672T26	1,300	1,583	1,592	
	Ratchet	74EL3672T26RA	1,860	2,142	2,150	
	Count Bal	74EL3672T26BL	3,203	3,483	3,553	
	Electric	74EL3672T26EH	3,162	3,444	3,453	
36 x 84	Static	74EL3684T26	1,508	1,837	1,835	
	Electric	74EL3684T26EH	3,369	3,699	3,695	
36 x 90	Static	74EL3690T26	1,621	1,995	1,971	
	Electric	74EL3690T26EH	3,482	3,857	3,832	
36 x 96 *	Static	74EL3696T26	1,621	1,995	1,983	
	Electric	74EL3696T26EH	3,482	3,857	3,845	

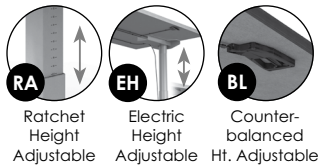

RA Ratchet Height Adjustable
EH Electric Height Adjustable
BL Counter-balanced Ht. Adjustable

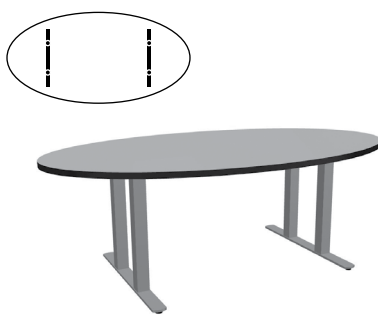
Elliptical with TT-bases	Top Size	Base	Model Number	3P	3K	3W
	42 x 72	Static	74EL4272TT32	\$ 2,204	\$ 2,533	\$ 2,519
		Electric	74EL4272TT32EH	5,720	6,050	6,034
	42 x 84	Static	74EL4284TT32	2,421	2,803	2,772
		Electric	74EL4284TT32EH	5,937	6,317	6,288
	42 x 90	Static	74EL4290TT32	2,562	2,999	2,940
		Electric	74EL4290TT32EH	6,077	6,515	6,455
	42 x 96 *	Static	74EL4296TT32	2,562	2,999	2,952
		Electric	74EL4296TT32EH	6,077	6,515	6,467
	48 x 72	Static	74EL4872TT36	2,328	2,702	2,665
		Electric	74EL4872TT36EH	8,217	8,592	8,555
	48 x 84	Static	74EL4884TT36	2,723	3,222	3,117
		Electric	74EL4884TT36EH	8,613	9,110	9,006
	48 x 90	Static	74EL4890TT36	2,723	3,222	3,128
		Electric	74EL4890TT36EH	8,613	9,110	9,018
	48 x 96 *	Static	74EL4896TT36	2,723	3,222	3,141
		Electric	74EL4896TT36EH	8,613	9,110	9,030



EH Electric Height Adjustable

* \$200 NET surcharge per order for oversized pallet

For VertiGo table options, please reference pages 176-177.

Top Size	Base	Model Number	3P	3K	3W	Elliptical with 3 TT-bases
42 x 120	Static	74EL42120TT32(3)	\$3,853	\$4,545	\$4,356	
42 x 144	Static	74EL42144TT32(3)	4,158	4,971	4,740	
48 x 120	Static	74EL48120TT36(3)	3,887	4,584	4,402	
48 x 144	Static	74EL48144TT36(3)	4,195	5,015	4,791	



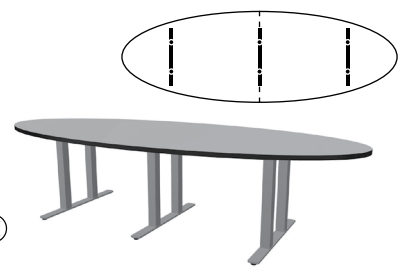



LC N/A SH quote 3 bases: X













Top Size	Base	Model Number	3P	3K	3W	Rectangle with H-base
18 x 30	Static	74TC1830H1524	\$1,053	\$1,107	\$1,190	
	Ratchet	74TC1830H1524RA	1,257	1,312	1,396	
	Count Bal	74TC1830H1524BL	1,666	1,719	1,803	
18 x 36	Static	74TC1836H1524	1,053	1,107	1,206	
	Ratchet	74TC1836H1524RA	1,257	1,312	1,411	
	Count Bal	74TC1836H1524BL	1,666	1,719	1,820	
20 x 30	Static	74TC2030H1524	1,066	1,125	1,210	
	Ratchet	74TC2030H1524RA	1,272	1,331	1,417	
	Count Bal	74TC2030H1524BL	1,680	1,739	1,824	
20 x 36	Static	74TC2036H1524	1,096	1,166	1,257	
	Ratchet	74TC2036H1524RA	1,300	1,372	1,463	
	Count Bal	74TC2036H1524BL	1,709	1,779	1,872	

Top Size	Base	Model Number	3P	3K	3W	Kidney Bean with H-base
18 x 30	Static	74KB1830H1524	\$1,254	\$1,389	\$1,424	
	Ratchet	74KB1830H1524RA	1,460	1,594	1,629	
	Count Bal	74KB1830H1524BL	1,867	2,002	2,039	
18 x 36	Static	74KB1836H1524	1,268	1,407	1,456	
	Ratchet	74KB1836H1524RA	1,473	1,613	1,662	
	Count Bal	74KB1836H1524BL	1,881	2,021	2,070	
20 x 30	Static	74KB2030H1524	1,256	1,393	1,433	
	Ratchet	74KB2030H1524RA	1,462	1,598	1,638	
	Count Bal	74KB2030H1524BL	1,869	2,005	2,046	
20 x 36	Static	74KB2036H1524	1,272	1,414	1,467	
	Ratchet	74KB2036H1524RA	1,477	1,619	1,672	
	Count Bal	74KB2036H1524BL	1,885	2,027	2,081	

For VertiGo table options, please reference pages 176-177.

Square with X-base		Top Size	Base	Model Number	3P	3K	3W
   Ratchet Height Adjustable  Hand Crank Height Adjustable  Short Balanced Ht. Adjustable  Counter-balanced Ht. Adjustable	24 x 24	Static	74SQ2424X22	\$ 747	\$ 796	\$ 885	
		Ratchet	74SQ2424X22RA	954	1,001	1,089	
		Crank	74SQ2424X22CR	1,029	1,077	1,166	
		Short Bal	74SQ2424X22BLS	1,253	1,301	1,390	
	30 x 30	Static	74SQ3030X26	832	907	1,006	
		Ratchet	74SQ3030X26RA	1,037	1,111	1,211	
		Crank	74SQ3030X26CR	1,112	1,186	1,287	
		Short Bal	74SQ3030X26BLS	1,334	1,407	1,508	
	36 x 36	Static	74SQ3636X32	931	1,035	1,143	
		Short Bal	74SQ3636X32BLS	1,431	1,536	1,644	
		Count Bal	74SQ3636X32BL	1,431	1,536	1,644	
	42 x 42	Static	74SQ4242X36	1,042	1,183	1,294	
	Short Bal	74SQ4242X36BLS	1,539	1,680	1,792		
	Count Bal	74SQ4242X36BL	1,539	1,680	1,792		

Square with Square Disc Base		Top Size	Base	Model Number	3P	3K	3W
   Short Balanced Ht. Adjustable  Counter-balanced Ht. Adjustable  Ratchet Height Adjustable  Disc base: +72	24 x 24	Static	74SQ2424QD16	\$ 761	\$ 809	\$ 897	
		Ratchet	74SQ2424QD16RA	973	1,021	1,109	
		Short Bal	74SQ2424QD16BLS	1,439	1,486	1,574	
	30 x 30	Static	74SQ3030QD16	826	898	999	
		Ratchet	74SQ3030QD16RA	1,036	1,110	1,210	
		Short Bal	74SQ3030QD16BLS	1,503	1,577	1,676	
	36 x 36	Static	74SQ3636QD20	943	1,048	1,157	
		Short Bal	74SQ3636QD20BLS	1,622	1,728	1,835	
		Count Bal	74SQ3636QD20BL	1,622	1,728	1,835	
	42 x 42	Static	74SQ4242QD26	1,169	1,311	1,422	
		Short Bal	74SQ4242QD26BLS	1,840	1,982	2,093	
		Count Bal	74SQ4242QD26BL	1,840	1,982	2,093	

Square with TT-bases		Top Size	Base	Model Number	3P	3K	3W
   Nesting TT  Electric Height Adjustable	48 x 48	Static	74SQ4848TT36	\$ 1,851	\$ 2,034	\$ 2,146	
		Nesting	74SQ4848TT36NE	2,922	3,102	3,211	
		Electric	74SQ4848TT36EH	7,739	7,924	8,035	

For VertiGo table options, please reference pages 176-177.

Top Size	Base	Model Number	3P	3K	3W	Round with X-base
24 x 24	Static	74RD24X22	\$ 787	\$ 851	\$ 900	
	Ratchet	74RD24X22RA	992	1,056	1,107	
	Crank	74RD24X22CR	1,069	1,133	1,183	
	Short Bal	74RD24X22BLS	1,293	1,357	1,406	
30 x 30	Static	74RD30X26	895	993	1,042	
	Ratchet	74RD30X26RA	1,100	1,199	1,247	
	Crank	74RD30X26CR	1,175	1,273	1,321	
	Short Bal	74RD30X26BLS	1,397	1,496	1,543	
36 x 36	Static	74RD36X32	1,006	1,142	1,187	
	Short Bal	74RD36X32BLS	1,507	1,643	1,688	
	Count Bal	74RD36X32BL	1,507	1,643	1,688	
42 x 42	Static	74RD42X32	1,129	1,313	1,346	
	Short Bal	74RD42X32BLS	1,629	1,814	1,846	
	Count Bal	74RD42X32BL	1,629	1,814	1,846	
48 x 48	Static	74RD48X36	1,183	1,381	1,427	
	Short Bal	74RD48X36BLS	1,680	1,879	1,925	
	Count Bal	74RD48X36BL	1,680	1,879	1,925	

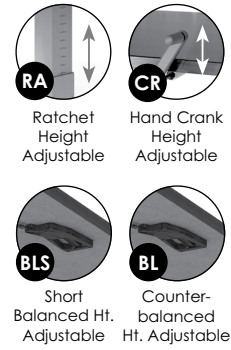



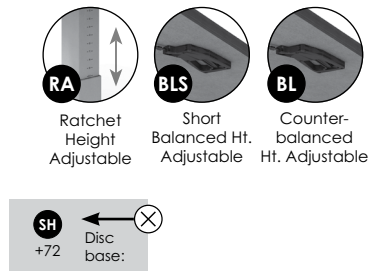

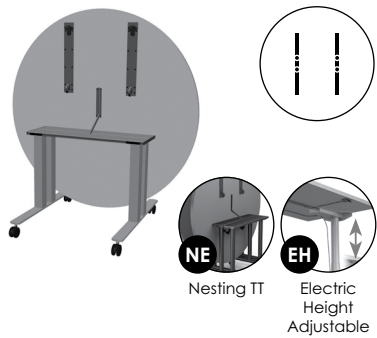
Top Size	Base	Model Number	3P	3K	3W	Round with Disc Base
24 x 24	Static	74RD24D20	\$ 801	\$ 865	\$ 914	
	Ratchet	74RD24D20RA	1,012	1,076	1,125	
	Short Bal	74RD24D20BLS	1,418	1,482	1,531	
30 x 30	Static	74RD30D20	888	986	1,035	
	Ratchet	74RD30D20RA	1,099	1,199	1,246	
	Short Bal	74RD30D20BLS	1,506	1,604	1,652	
36 x 36	Static	74RD36D24	1,021	1,157	1,201	
	Short Bal	74RD36D24BLS	1,953	2,089	2,134	
	Count Bal	74RD36D24BL	1,953	2,089	2,134	
42 x 42	Static	74RD42D24	1,142	1,328	1,359	
	Short Bal	74RD42D24BLS	2,076	2,260	2,293	
	Count Bal	74RD42D24BL	2,076	2,260	2,293	
48 x 48	Static	74RD48D32	1,311	1,509	1,556	
	Short Bal	74RD48D32BLS	2,238	2,435	2,483	
	Count Bal	74RD48D32BL	2,238	2,435	2,483	

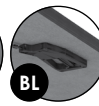

Top Size	Base	Model Number	3P	3K	3W	Round with TT-bases
48 x 48	Static	74RD48TT32	\$ 1,877	\$ 2,075	\$ 2,121	
	Nesting	74RD48TT32NE	2,947	3,142	3,187	
	Electric	74RD48TT32EH	5,391	5,590	5,636	
54 x 54	Static	74RD54TT32	2,076	2,354	2,365	
	Nesting	74RD54TT32NE	3,143	3,415	3,427	
	Electric	74RD54TT32EH	5,591	5,869	5,879	
60 x 60	Static	74RD60TT36	2,113	2,402	2,430	
	Nesting	74RD60TT36NE	3,180	3,464	3,491	
	Electric	74RD60TT36EH	8,003	8,291	8,320	

For VertiGo table options, please reference pages 176-177.

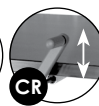
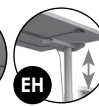
D-shaped with T-bases	Top Size	Base	Model Number	3P	3K	3W
  <div style="display: flex; justify-content: space-around; margin-top: 20px;"> <div style="text-align: center;">  <p>NE Nesting T</p> </div> <div style="text-align: center;">  <p>BL Counter-balanced Ht. Adjustable</p> </div> </div> <div style="display: flex; justify-content: space-around; margin-top: 20px;"> <div style="text-align: center;">  <p>RA Ratchet Height Adjustable</p> </div> <div style="text-align: center;">  <p>CR Hand Crank Height Adjustable</p> </div> <div style="text-align: center;">  <p>EH Electric Height Adjustable</p> </div> </div>	24 x 36	Static	74D2436T22	\$ 810	\$ 903	\$ 976
	Nesting	74D2436T22NE	1,502	1,593	1,664	
	Ratchet	74D2436T22RA	1,368	1,462	1,533	
	Crank	74D2436T22CR	1,537	1,630	1,703	
	Electric	74D2436T22EH	2,673	2,766	2,838	
	24 x 48	Static	74D2448T22	889	1,013	1,094
	Nesting	74D2448T22NE	1,578	1,701	1,778	
	Ratchet	74D2448T22RA	1,446	1,571	1,650	
	Crank	74D2448T22CR	1,615	1,740	1,820	
	Count Bal	74D2448T22BL	2,737	2,862	2,942	
	Electric	74D2448T22EH	2,749	2,875	2,954	
	24 x 60	Static	74D2460T22	966	1,123	1,210
	Nesting	74D2460T22NE	1,654	1,808	1,893	
	Ratchet	74D2460T22RA	1,525	1,682	1,769	
	Crank	74D2460T22CR	1,693	1,850	1,937	
	Count Bal	74D2460T22BL	2,870	3,027	3,114	
	Electric	74D2460T22EH	2,828	2,985	3,072	
	24 x 72	Static	74D2472T22	1,045	1,232	1,328
Nesting	74D2472T22NE	1,774	1,958	2,050		
Ratchet	74D2472T22RA	1,603	1,791	1,885		
Crank	74D2472T22CR	1,772	1,959	2,054		
Count Bal	74D2472T22BL	2,951	3,139	3,233		
Electric	74D2472T22EH	2,906	3,094	3,188		
24 x 84	Static	74D2484T22	1,211	1,430	1,532	
Nesting	74D2484T22NE	2,043	2,258	2,358		
Electric	74D2484T22EH	3,073	3,292	3,394		
24 x 90	Static	74D2490T22	1,250	1,485	1,591	
Nesting	74D2490T22NE	2,082	2,310	2,415		
Electric	74D2490T22EH	3,113	3,346	3,453		
24 x 96 *	Static	74D2496T22	1,290	1,540	1,649	
Nesting	74D2496T22NE	2,119	2,365	2,473		
Electric	74D2496T22EH	3,150	3,401	3,512		
30 x 48	Static	74D3048T26	986	1,143	1,211	
Nesting	74D3048T26NE	1,674	1,827	1,894		
Ratchet	74D3048T26RA	1,546	1,703	1,771		
Crank	74D3048T26CR	1,712	1,867	1,936		
Count Bal	74D3048T26BL	2,831	2,988	3,056		
Electric	74D3048T26EH	2,848	3,005	3,073		
30 x 60	Static	74D3060T26	1,085	1,279	1,351	
Nesting	74D3060T26NE	1,771	1,962	2,031		
Ratchet	74D3060T26RA	1,644	1,839	1,908		
Crank	74D3060T26CR	1,809	2,005	2,075		
Count Bal	74D3060T26BL	2,939	3,135	3,205		
Electric	74D3060T26EH	2,946	3,141	3,211		

* \$200 NET surcharge per order for oversized pallet

For VertiGo table options, please reference pages 176-177.

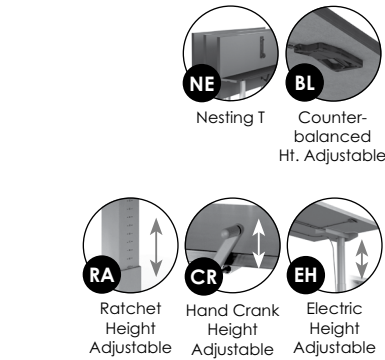
Top Size	Base	Model Number	3P	3K	3W	D-shaped with T-bases	
30 x 72	Static	74D3072T26	\$ 1,182	\$ 1,417	\$ 1,488		
	Nesting	74D3072T26NE	1,908	2,137	2,209		
	Ratchet	74D3072T26RA	1,740	1,976	2,047		
	Crank	74D3072T26CR	1,907	2,141	2,214		
	Count Bal	74D3072T26BL	3,083	3,317	3,390		
	Electric	74D3072T26EH	3,043	3,278	3,349		
30 x 84	Static	74D3084T26	1,368	1,642	1,715		
	Nesting	74D3084T26NE	2,197	2,465	2,536		
	Electric	74D3084T26EH	3,229	3,503	3,577		
30 x 90	Static	74D3090T26	1,417	1,710	1,784		
	Electric	74D3090T26EH	3,279	3,570	3,646		
30 x 96 *	Static	74D3096T26	1,466	1,778	1,855		
	Electric	74D3096T26EH	3,327	3,639	3,715		
36 x 48	Static	74D3648T26	1,065	1,252	1,310		
	Nesting	74D3648T26NE	1,751	1,935	1,991		
	Ratchet	74D3648T26RA	1,624	1,812	1,868		
	Crank	74D3648T26CR	1,790	1,978	2,034		
	Count Bal	74D3648T26BL	2,909	3,097	3,154		
	Electric	74D3648T26EH	2,926	3,114	3,170		
36 x 60	Static	74D3660T26	1,182	1,417	1,469		
	Nesting	74D3660T26NE	1,956	2,187	2,238		
	Ratchet	74D3660T26RA	1,740	1,976	2,028		
	Crank	74D3660T26CR	1,907	2,141	2,194		
	Count Bal	74D3660T26BL	3,037	3,271	3,324		
	Electric	74D3660T26EH	3,043	3,278	3,330		
36 x 72	Static	74D3672T26	1,299	1,581	1,629		
	Nesting	74D3672T26NE	2,189	2,464	2,512		
	Ratchet	74D3672T26RA	1,858	2,139	2,189		
	Crank	74D3672T26CR	2,024	2,305	2,355		
	Count Bal	74D3672T26BL	3,201	3,481	3,551		
	Electric	74D3672T26EH	3,161	3,442	3,491		
36 x 84	Static	74D3684T26	1,505	1,834	1,878		
	Electric	74D3684T26EH	3,366	3,694	3,740		
36 x 90	Static	74D3690T26	1,563	1,915	1,958		
	Electric	74D3690T26EH	3,426	3,777	3,819		
36 x 96 *	Static	74D3696T26	1,622	1,998	2,039		
	Electric	74D3696T26EH	3,483	3,858	3,899		

* \$200 NET surcharge per order for oversized pallet

For VertiGo table options, please reference pages 176-177.

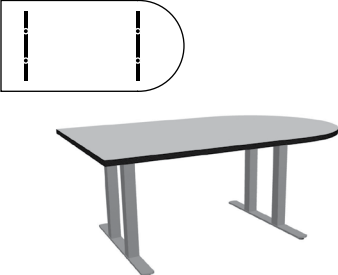
D-shaped with TT-bases	Top Size	Base	Model Number	3P	3K	3W
	42 x 60	Static	74D4260TT32	\$2,431	\$2,851	\$2,777
		Nesting	74D4260TT32NE	3,492	3,903	3,831
		Electric	74D4260TT32EH	5,947	6,367	6,292
	42 x 72	Static	74D4272TT32	2,431	2,851	2,808
		Nesting	74D4272TT32NE	3,492	3,903	3,861
		Electric	74D4272TT32EH	5,947	6,367	6,324
	42 x 84	Static	74D4284TT32	2,552	2,986	2,964
		Electric	74D4284TT32EH	6,067	6,500	6,479
	42 x 90	Static	74D4290TT32	2,631	3,095	3,064
Electric		74D4290TT32EH	6,145	6,609	6,580	
42 x 96 *	Static	74D4296TT32	2,707	3,203	3,165	
	Electric	74D4296TT32EH	6,223	6,717	6,680	
48 x 60	Static	74D4860TT36	2,485	2,923	2,848	
	Nesting	74D4860TT32NE	3,544	3,974	3,900	
	Electric	74D4860TT36EH	8,374	8,812	8,738	
48 x 72	Static	74D4872TT36	2,485	2,923	2,879	
	Nesting	74D4872TT32NE	3,544	3,974	3,931	
	Electric	74D4872TT36EH	8,374	8,812	8,768	
48 x 84	Static	74D4884TT36	2,573	3,011	2,998	
	Electric	74D4884TT36EH	8,462	8,900	8,887	
48 x 90	Static	74D4890TT36	2,652	3,121	3,100	
	Electric	74D4890TT36EH	8,541	9,009	8,990	
48 x 96 *	Static	74D4896TT36	2,729	3,230	3,202	
	Electric	74D4896TT36EH	8,619	9,120	9,091	



Nesting TT



Electric Height Adjustable

Half Round with T-bases	Top Size	Base	Model Number	3P	3K	3W
	24 x 48	Static	74HR2448T18	\$ 872	\$ 999	\$1,064
		Nesting	74HR2448T18NE	1,562	1,687	1,750
		Ratchet	74HR2448T18RA	1,430	1,557	1,622
		Electric	74HR2448T18EH	2,738	2,863	2,928
30 x 60	Static	74HR3060T22	1,066	1,263	1,315	
	Nesting	74HR3060T22NE	1,752	1,945	1,997	
	Ratchet	74HR3060T22RA	1,624	1,820	1,873	
	Count Bal	74HR3060T22BL	2,969	3,165	3,218	
	Electric	74HR3060T22EH	2,927	3,123	3,176	
36 x 72	Static	74HR3672T26	1,297	1,579	1,607	
	Nesting	74HR3672T26NE	2,112	2,387	2,415	
	Ratchet	74HR3672T26RA	1,857	2,137	2,167	
	Count Bal	74HR3672T26BL	3,200	3,479	3,510	
	Electric	74HR3672T26EH	3,160	3,439	3,470	

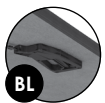

Counter-balanced Ht. Adjustable



Electric Height Adjustable





Ratchet Height Adjustable



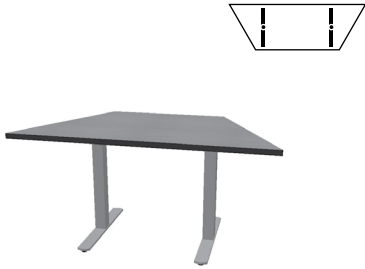

Nesting TT

* \$200 NET surcharge per order for oversized pallet

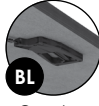
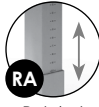
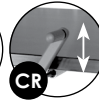
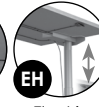
For VertiGo table options, please reference pages 176-177.

Top Size	Base	Model Number	3P	3K	3W	Trapezoid with T-bases
24 x 48	Static	74TZ2448T18	\$ 863	\$ 984	\$1,053	   Nesting T Counter-balanced Ht. Adjustable    Ratchet Height Adjustable Hand Crank Height Adjustable Electric Height Adjustable
	Ratchet	74TZ2448T18RA	1,420	1,542	1,609	
	Crank	74TZ2448T18CR	1,592	1,714	1,782	
	Electric	74TZ2448T18EH	2,726	2,849	2,917	
24 x 72	Static	74TZ2472T18	1,061	1,263	1,351	
	Nesting	74TZ2472T18NE	1,747	1,945	2,031	
	Ratchet	74TZ2472T18RA	1,619	1,820	1,908	
	Crank	74TZ2472T18CR	1,791	1,992	2,081	
	Count Bal	74TZ2472T18BL	2,984	3,185	3,273	
	Electric	74TZ2472T18EH	2,925	3,126	3,215	
30 x 60	Static	74TZ3060T22	1,014	1,189	1,257	
	Nesting	74TZ3060T22NE	1,701	1,873	1,940	
	Ratchet	74TZ3060T22RA	1,572	1,748	1,816	
	Crank	74TZ3060T22CR	1,740	1,916	1,984	
	Count Bal	74TZ3060T22BL	2,921	3,096	3,164	
	Electric	74TZ3060T22EH	2,875	3,051	3,119	
36 x 72	Static	74TZ3672T26	1,270	1,540	1,578	
	Nesting	74TZ3672T26NE	2,085	2,349	2,386	
	Ratchet	74TZ3672T26RA	1,829	2,098	2,135	
	Crank	74TZ3672T26CR	1,995	2,264	2,302	
	Count Bal	74TZ3672T26BL	3,170	3,440	3,478	
	Electric	74TZ3672T26EH	3,131	3,401	3,438	

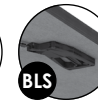
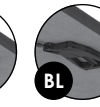
Top Size	Base	Model Number	3P	3K	3W	Squire with X-base
24 x 24	Static	74SL24X22	\$ 969	\$ 1,106	\$ 1,128	    Ratchet Height Adjustable Short Balanced Ht. Adjustable Counter-balanced Ht. Adjustable
	Ratchet	74SL24X22RA	1,174	1,311	1,333	
	Short Bal	74SL24X22BLS	1,475	1,610	1,632	
30 x 30	Static	74SL30X26	1,048	1,208	1,244	
	Ratchet	74SL30X26RA	1,253	1,414	1,448	
	Short Bal	74SL30X26BLS	1,550	1,710	1,746	
36 x 36	Static	74SL36X32	1,133	1,319	1,365	
	Short Bal	74SL36X32BLS	1,634	1,820	1,866	
	Count Bal	74SL36X32BL	1,634	1,820	1,866	
42 x 42	Static	74SL42X36	1,225	1,440	1,496	
	Short Bal	74SL42X36BLS	1,722	1,937	1,993	
	Count Bal	74SL42X36BL	1,722	1,937	1,993	

For VertiGo table options, please reference pages 176-177.

table 

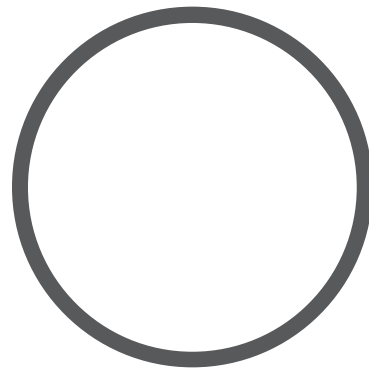

99 surge
price list
Effective January 1, 2023

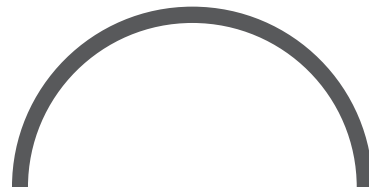



Surge series tables are sleek, stylish, and versatile. With height adjustable options and a variety of top shapes and sizes, Surge provides a sophisticated solution for any space.

Surge Base Styles

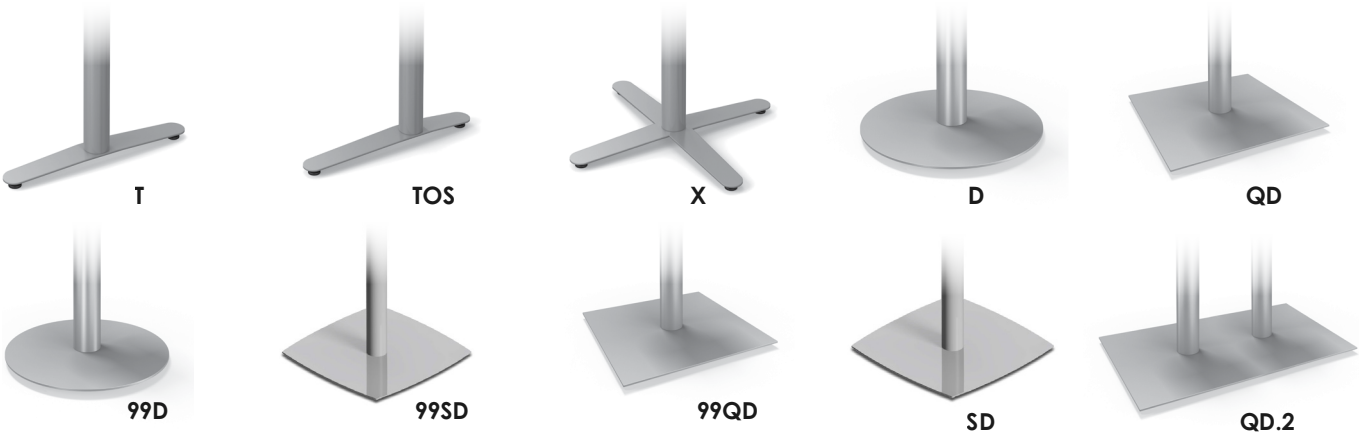

Surge Options

Standard Glides



Locking Casters



- LC Locking Casters**
can be added to any table for \$111 per set of four.
- FD Folding Bases**
priced accordingly with standard glides.
- NE Nesting Tables**
priced accordingly with locking casters.
- FT Flip Tops**
available on disc and X-based tables for \$138. Not available on counterbalanced tables.

- OS Offset T-bases**
available for \$39 per table.
- CH Chrome Finish**
is not available on Surge tables.
- WM Wire Management**
Built-in wire management is not available on Surge tables.
- WMLC Wire Management Leg Covers**
snap onto any round column and are \$50 each for 2" and \$79 each for 3".

- SH Special Height**
can be added to any table:
+ \$72 per column for heights > 29"
+ \$39 per column for heights < 29"
Special height tables with tops larger than 36x72" must be custom quoted.
- FR Footring**
is not available on Surge tables.
- PB Powerbox Mounting Plate**
is available on disc and X-bases for \$100.

Surge Height Adjustable Options

EH Electric Height is available on T-bases and is available in two finishes:

- 37 Satin Silver
- 57 Jet

BL Counterbalanced and Short Balanced are available on disc and X-bases. Available height adjustable finishes can be found on page 9.

Surge Top Shapes

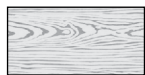

Rectangle
p.200



Boat
p.203



Racetrack
p.204

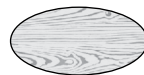

Elliptical
p.205



Squircle
p.206



Square
p.206



Round
p.207



D-shaped
p.208



Half Round
p.210



Trapezoid
p.210

Surge Top Options

GG Quick-Connect Ganging Brackets can be added to any table for \$45 (includes 4 connectors per table).

RC 3" Radius Corners can be added to any table for \$61.

GR Grommets can be added to any table for \$45 each. To see specific locations, see page 227.

Surge Edge Options

(corresponds with 3 columns of pricing)

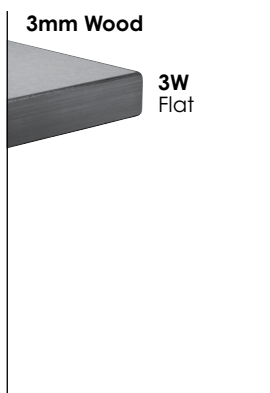
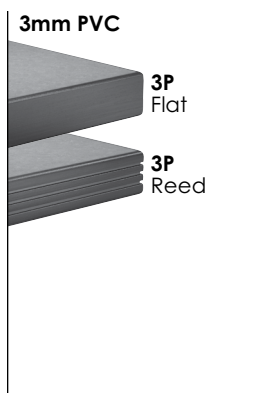

Electric Height Adjustable T-bases

Electric height adjustability gives you the ability to go from sitting to standing height at the push of a button. With a weight capacity of 225 lbs. per table, Surge is strong enough to work in many different applications.

The standard memory keypad will remember your four favorite heights.

Want to use Surge on the go? Simply add 2" to each vertical measurement to account for locking casters.

To specify:
All available electric models are priced in the following pages. They are denoted by the "EH" at the end of the model number.

Example:
99TC2460T22EH-3P
24x60" **electric height** table

\$2,424 List Price

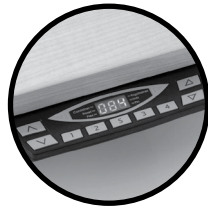

Standard Memory Keypad

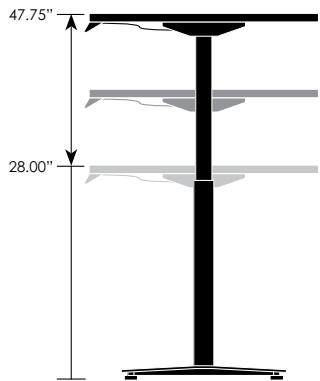

T-bases

Counterbalanced & Short Balanced Height Adjustable Disc & X-bases

Counterbalanced tables go from seated-to-standing height, while the short balanced goes from coffee-to-seated height. Available on tables using single column disc or X-bases, these tables are easy to adjust. Simply squeeze the small handle underneath and gently move the top to your desired height. It's that easy.

Want to use Surge on the go? Simply add 2" to each vertical measurement to account for the added height of locking casters.

To specify:
All available counterbalanced models are priced in the following pages. They are denoted by the "BL" or "BLS" (for short balanced) at the end of the model number.

Example:
99RD36X30BL-3P
36" round **counterbalanced** table
\$1,914 List Price

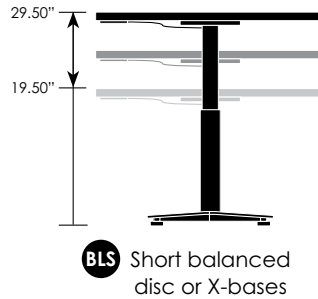
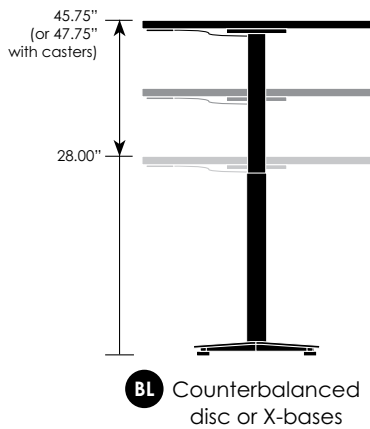
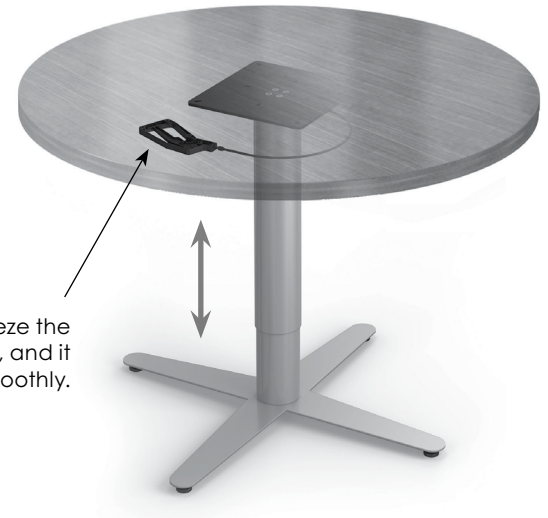

Counterbalanced Height Ranges:

Smaller Surge tables using smaller bases have a 17.75" range, while the larger tables using larger bases have an extended range of 19.75". See the list below for ranges of used on specific top shapes and sizes. All counterbalanced tables have a starting height of 28".

Square	Range	Max Ht.	Round	Range	Max Ht.
36" SQ 42" SQ	19.75"	47.75"	36" RD-X 36" BU	17.75"	45.75"
			36" RD-D 42" RD 48" RD	19.75"	47.75"

Rectangular with T-bases	Top Size	Base	Model Number	3P	3K	3W
    <p>Folding T Nesting T Electric Height Adjustable</p>	24 x 36	Static	99TC2436T22	\$ 787	\$ 858	\$ 960
		Nesting	99TC2436T22NE	1,478	1,548	1,648
		Electric	99TC2436T22EH	2,462	2,532	2,635
	24 x 48	Static	99TC2448T22	845	939	1,055
		Folding	99TC2448T22FD	1,173	1,267	1,383
		Nesting	99TC2448T22NE	1,535	1,627	1,740
		Electric	99TC2448T22EH	2,519	2,613	2,729
	24 x 60	Static	99TC2460T22	871	976	1,116
		Folding	99TC2460T22FD	1,212	1,317	1,456
		Nesting	99TC2460T22NE	1,561	1,664	1,800
		Electric	99TC2460T22EH	2,546	2,651	2,789
	24 x 72	Static	99TC2472T22	920	1,045	1,201
Folding		99TC2472T22FD	1,263	1,386	1,542	
Nesting		99TC2472T22NE	1,844	1,967	2,119	
Electric		99TC2472T22EH	2,595	2,720	2,875	
24 x 84	Static	99TC2484T22	1,106	1,268	1,426	
	Folding	99TC2484T22FD	1,358	1,521	1,679	
	Nesting	99TC2484T22NE	1,939	2,099	2,254	
24 x 90	Static	99TC2490T22	1,163	1,349	1,505	
	Folding	99TC2490T22FD	1,417	1,602	1,758	
	Nesting	99TC2490T22NE	1,995	2,177	2,330	
24 x 96 *	Static	99TC2496T22	1,163	1,349	1,520	
	Folding	99TC2496T22FD	1,417	1,602	1,774	
	Nesting	99TC2496T22NE	1,995	2,177	2,346	
30 x 36	Static	99TC3036T26	837	926	1,031	
	Nesting	99TC3036T26NE	1,529	1,615	1,717	
	Electric	99TC3036T26EH	2,514	2,601	2,707	
30 x 48	Static	99TC3048T26	910	1,025	1,141	
	Folding	99TC3048T26FD	1,238	1,354	1,468	
	Nesting	99TC3048T26NE	1,599	1,712	1,824	
	Electric	99TC3048T26EH	2,586	2,702	2,817	
30 x 60	Static	99TC3060T26	932	1,057	1,196	
	Folding	99TC3060T26FD	1,273	1,398	1,538	
	Nesting	99TC3060T26NE	1,620	1,742	1,880	
	Electric	99TC3060T26EH	2,608	2,733	2,872	
30 x 72	Static	99TC3072T26	986	1,134	1,289	
	Folding	99TC3072T26FD	1,329	1,476	1,629	
	Nesting	99TC3072T26NE	1,909	2,054	2,204	
	Electric	99TC3072T26EH	2,663	2,810	2,965	

* \$200 NET surcharge per order for oversized pallet

For Surge table options, please reference pages 196-199.

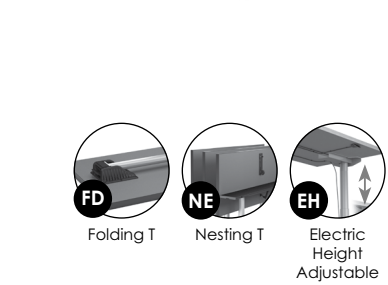
Top Size	Base	Model Number	3P	3K	3W	Rectangular with T-bases	
30 x 84	Static	99TC3084T26	\$ 1,210	\$ 1,412	\$ 1,557		
	Folding	99TC3084T26FD	1,464	1,666	1,811		
	Nesting	99TC3084T26NE	2,042	2,240	2,381		
30 x 90	Static	99TC3090T26	1,283	1,512	1,650		
	Folding	99TC3090T26FD	1,536	1,767	1,904		
30 x 96 *	Static	99TC3096T26	1,283	1,512	1,666		
	Folding	99TC3096T26FD	1,536	1,767	1,919		
36 x 48	Static	99TC3648T26	965	1,105	1,218		
	Folding	99TC3648T26FD	1,293	1,432	1,546		
	Nesting	99TC3648T26NE	1,785	1,922	2,033		
	Electric	99TC3648T26EH	2,641	2,781	2,894		
36 x 60	Static	99TC3660T26	1,050	1,223	1,342		
	Folding	99TC3660T26FD	1,393	1,564	1,684		
	Nesting	99TC3660T26NE	1,945	2,113	2,231		
	Electric	99TC3660T26EH	2,726	2,900	3,018		
36 x 72	Static	99TC3672T26	1,103	1,297	1,432		
	Folding	99TC3672T26FD	1,445	1,640	1,774		
	Nesting	99TC3672T26NE	2,024	2,215	2,346		
	Electric	99TC3672T26EH	2,779	2,974	3,107		
36 x 84	Static	99TC3684T26	1,309	1,549	1,679		
	Folding	99TC3684T26FD	1,561	1,802	1,932		
36 x 90	Static	99TC3690T26	1,393	1,666	1,787		
	Folding	99TC3690T26FD	1,645	1,919	2,041		
36 x 96 *	Static	99TC3696T26	1,393	1,666	1,802		
	Folding	99TC3696T26FD	1,645	1,919	2,056		

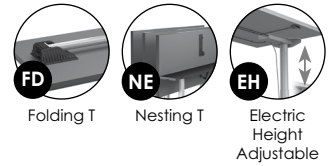

* \$200 NET surcharge per order for oversized pallet

For Surge table options, please reference pages 196-199.

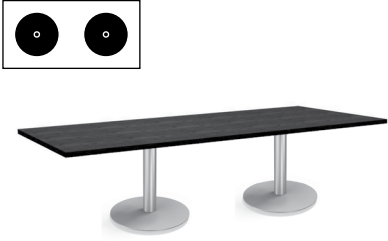
Rectangular with 2 Thin Disc Bases	Top Size	Base	Model Number	3P	3K	3W
	24 x 60	Static	99TC2460D20	\$ 1,477	\$ 1,581	\$ 1,720
	24 x 72	Static	99TC2472D20	1,527	1,650	1,805
	24 x 84	Static	99TC2484D20	1,623	1,784	1,944
	24 x 90	Static	99TC2490D20	1,769	1,953	2,110
	24 x 96 *	Static	99TC2496D20	1,769	1,953	2,126
	30 x 60	Static	99TC3060D20	1,529	1,653	1,793
	30 x 72	Static	99TC3072D20	1,584	1,732	1,885
	30 x 84	Static	99TC3084D20	1,719	1,922	2,066
	30 x 90	Static	99TC3090D20	1,880	2,109	2,247
	30 x 96 *	Static	99TC3096D20	1,880	2,109	2,263
	36 x 72	Static	99TC3672D24	1,781	1,977	2,110
	36 x 84	Static	99TC3684D24	1,899	2,138	2,268
	36 x 90	Static	99TC3690D24	2,070	2,345	2,465
	36 x 96 *	Static	99TC3696D24	2,070	2,345	2,481
	42 x 72	Static	99TC4272D32	2,172	2,414	2,528
	42 x 84	Static	99TC4284D32	2,267	2,550	2,664
	42 x 90	Static	99TC4290D32	2,451	2,769	2,872
	42 x 96 *	Static	99TC4296D32	2,451	2,769	2,887

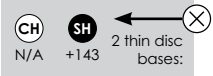

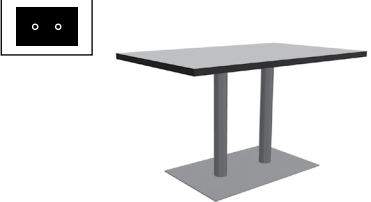
Rectangle with 2-column Disc Base	Top Size	Base	Model Number	3P	3K	3W
	24 x 36	Static	99TC2436QD2032.2	\$ 1,389	\$ 1,460	\$ 1,562
	24 x 48	Static	99TC2448QD2032.2	1,446	1,540	1,656
	30 x 36	Static	99TC3036QD2032.2	1,431	1,519	1,624
	30 x 48	Static	99TC3048QD2032.2	1,503	1,619	1,733
	36 x 48	Static	99TC3648QD2032.2	1,559	1,696	1,811

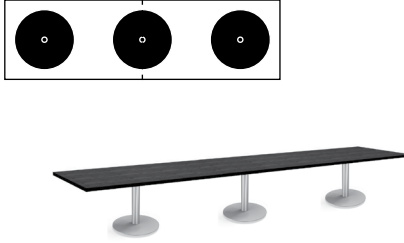
Rectangular with 3 Thin Disc Bases	Top Size	Base	Model Number	3P	3K	3W
	42 x 120	Static	99TC42120D32(3)-TJ	\$3,586	\$4,061	\$4,124
	42 x 144	Static	99TC42144D32(3)-TJ	3,780	4,332	4,400

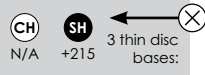



* \$200 NET surcharge per order for oversized pallet

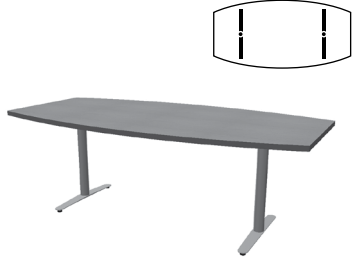

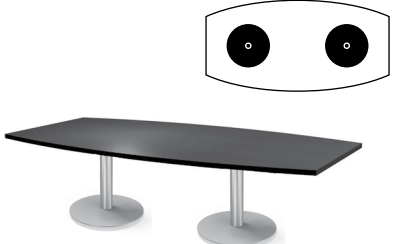
For Surge table options, please reference pages 196-199.

Top Size	Base	Model Number	3P	3K	3W	Boat-shaped with T-bases
30 x 42 x 84	Static	99BT3084T26	\$1,662	\$2,044	\$2,037	
30 x 42 x 90	Static	99BT3090T26	1,797	2,234	2,201	
30 x 42 x 96 *	Static	99BT3096T26	1,797	2,234	2,217	

Top Size	Base	Model Number	3P	3K	3W	Boat-shaped with 2 Thin Disc Bases
30 x 42 x 84	Static	99BT3084D24	\$2,252	\$2,634	\$2,628	
30 x 42 x 90	Static	99BT3090D24	2,475	2,911	2,880	
30 x 42 x 96 *	Static	99BT3096D24	2,475	2,911	2,895	
36 x 48 x 84	Static	99BT3684D32	2,654	3,090	3,052	
36 x 48 x 90	Static	99BT3690D32	2,896	3,393	3,325	
36 x 48 x 96 *	Static	99BT3696D32	2,896	3,393	3,341	

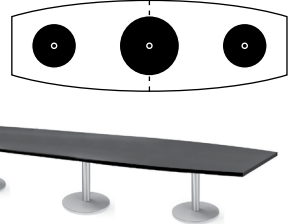



 →  
 2 thin disc bases: N/A +143

Top Size	Base	Model Number	3P	3K	3W	Boat-shaped with 3 Thin Disc Bases
36 x 48 x 120	Static	99BT36120D243224-TJ	\$3,877	\$4,575	\$4,435	
36 x 48 x 144	Static	99BT36144D243224-TJ	4,186	5,006	4,836	

  ← 
 3 thin disc bases: N/A +215

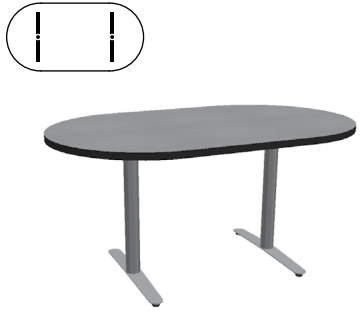
* \$200 NET surcharge per order for oversized pallet

For Surge table options, please reference pages 196-199.

Racetrack with T-bases	Top Size	Base	Model Number	3P	3K	3W
    <p>Folding T Nesting T Electric Height Adjustable</p>	36 x 60	Static	99RT3660T26	\$ 1,322	\$ 1,605	\$ 1,603
		Nesting	99RT3660T26NE	2,136	2,413	2,411
		Electric	99RT3660T26EH	2,990	3,271	3,269
	36 x 72	Static	99RT3672T26	1,322	1,605	1,634
		Folding	99RT3672T26FD	1,665	1,947	1,976
		Nesting	99RT3672T26NE	2,213	2,488	2,517
		Electric	99RT3672T26EH	2,990	3,271	3,300
	36 x 84	Static	99RT3684T26	1,658	2,040	2,024
		Folding	99RT3684T26FD	1,911	2,292	2,278
	36 x 90	Static	99RT3690T26	1,797	2,234	2,193
		Folding	99RT3690T26FD	2,050	2,486	2,446
	36 x 96 *	Static	99RT3696T26	1,797	2,234	2,209
Folding		99RT3696T26FD	2,050	2,486	2,462	

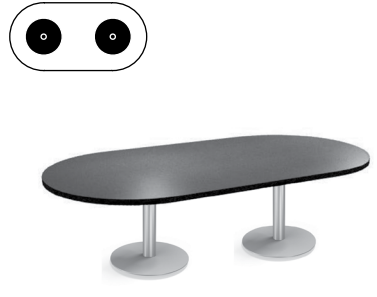
Racetrack with 2 Thin Disc Bases	Top Size	Base	Model Number	3P	3K	3W
	36 x 72	Static	99RT3672D20	\$ 1,921	\$ 2,202	\$ 2,232
	36 x 84	Static	99RT3684D20	2,168	2,548	2,533
	36 x 90	Static	99RT3690D20	2,394	2,830	2,789
	36 x 96 *	Static	99RT3696D20	2,394	2,830	2,806
	42 x 84	Static	99RT4284D24	2,249	2,630	2,623
	42 x 90	Static	99RT4290D24	2,475	2,911	2,880
	42 x 96 *	Static	99RT4296D24	2,475	2,911	2,895
	48 x 84	Static	99RT4884D32	2,808	3,305	3,220
	48 x 90	Static	99RT4890D32	2,896	3,393	3,324
	48 x 96 *	Static	99RT4896D32	2,896	3,393	3,339

CH N/A SH +143 ← 2 thin disc bases: (X)

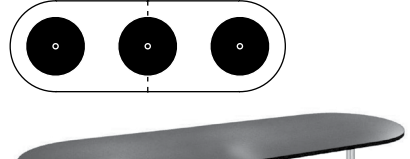
Racetrack with 3 Thin Disc Bases	Top Size	Base	Model Number	3P	3K	3W
	42 x 120	Static	99RT42120D24(3)	\$ 3,726	\$ 4,418	\$ 4,272
	42 x 144	Static	99RT42144D24(3)	4,031	4,844	4,670
	48 x 120	Static	99RT48120D32(3)	4,146	4,843	4,702
	48 x 144	Static	99RT48144D32(3)	4,454	5,276	5,103

CH N/A SH +215 ← 3 thin disc bases: (X)

* \$200 NET surcharge per order for oversized pallet

For Surge table options, please reference pages 196-199.

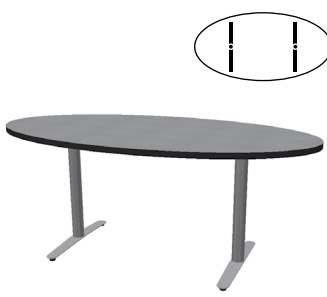
Top Size	Base	Model Number	3P	3K	3W	Elliptical with T-bases
30 x 54	Static	99EL3054T22	\$1,055	\$1,233	\$1,271	
	Electric	99EL3054T22EH	2,729	2,908	2,946	
30 x 60	Static	99EL3060T22	1,102	1,299	1,335	
	Electric	99EL3060T22EH	2,777	2,973	3,009	
36 x 60	Static	99EL3660T26	1,210	1,446	1,465	
	Electric	99EL3660T26EH	2,886	3,123	3,141	
36 x 72	Static	99EL3672T26	1,322	1,605	1,614	
	Electric	99EL3672T26EH	2,999	3,281	3,290	
36 x 84	Static	99EL3684T26	1,530	1,860	1,857	
36 x 90	Static	99EL3690T26	1,644	2,018	1,993	
36 x 96 *	Static	99EL3696T26	1,644	2,018	2,005	



Top Size	Base	Model Number	3P	3K	3W	Elliptical with 2 Thin Disc Bases
36 x 72	Static	99EL3672D20	\$1,921	\$2,202	\$2,211	
36 x 84	Static	99EL3684D20	2,039	2,368	2,366	
36 x 90	Static	99EL3690D20	2,240	2,615	2,591	
36 x 96 *	Static	99EL3696D20	2,240	2,615	2,602	
42 x 72	Static	99EL4272D24	2,120	2,450	2,434	
42 x 84	Static	99EL4284D24	2,249	2,630	2,599	
42 x 90	Static	99EL4290D24	2,478	2,915	2,855	
42 x 96 *	Static	99EL4296D24	2,478	2,915	2,867	
48 x 84	Static	99EL4884D32	2,808	3,306	3,202	
48 x 90	Static	99EL4890D32	2,897	3,394	3,302	
48 x 96 *	Static	99EL4896D32	2,897	3,394	3,314	



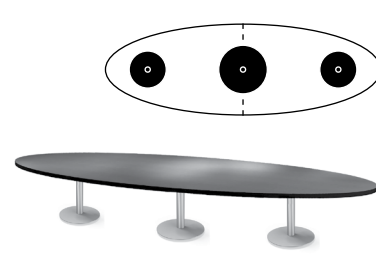

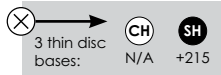





Top Size	Base	Model Number	3P	3K	3W	Elliptical with 3 Thin Disc Bases
42 x 120	Static	99EL42120D24(3)	\$3,726	\$4,418	\$4,229	
42 x 144	Static	99EL42144D24(3)	4,031	4,844	4,614	
48 x 120	Static	99EL48120D32(3)	4,146	4,843	4,662	
48 x 144	Static	99EL48144D32(3)	4,454	5,276	5,050	





* \$200 NET surcharge per order for oversized pallet



For Surge table options, please reference pages 196-199.



Squiracle with X-base	Top Size	Base	Model Number	3P	3K	3W
  Short Balanced Ht. Adjustable  Counter-balanced Ht. Adjustable	24 x 24	Static	99SL24X22	\$ 851	\$ 987	\$ 1,010
		Short Bal	99SL24X22BLS	1,466	1,603	1,625
	30 x 30	Static	99SL30X26	914	1,074	1,109
		Short Bal	99SL30X26BLS	1,533	1,693	1,730
	36 x 36	Static	99SL36X30	1,073	1,259	1,306
		Short Bal	99SL36X30BLS	2,040	2,225	2,274
		Count Bal	99SL36X30BL	2,040	2,225	2,274
	42 x 42	Static	99SL42X30	1,144	1,359	1,416
		Short Bal	99SL42X30BLS	2,112	2,327	2,384
		Count Bal	99SL42X30BL	2,112	2,327	2,384



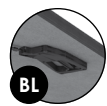

Squiracle with Thin Squiracle Disc Base	Top Size	Base	Model Number	3P	3K	3W
  Short Balanced Ht. Adjustable  Counter-balanced Ht. Adjustable  N/A  +72  N/A Thin disc bases:	24 x 24	Static	99SL24SD16	\$ 984	\$ 1,121	\$ 1,143
		Short Bal	99SL24SD16BLS	1,659	1,796	1,818
	30 x 30	Static	99SL30SD16	1,043	1,204	1,239
		Short Bal	99SL30SD16BLS	1,718	1,879	1,914
	36 x 36	Static	99SL36SD20	1,147	1,333	1,380
		Short Bal	99SL36SD20BLS	1,825	2,012	2,058
		Count Bal	99SL36SD20BL	1,825	2,012	2,058
	42 x 42	Static	99SL42SD26	1,371	1,585	1,642
		Short Bal	99SL42SD26BLS	2,024	2,239	2,296
		Count Bal	99SL42SD26BL	2,024	2,239	2,296

Square with X-base	Top Size	Base	Model Number	3P	3K	3W
  Short Balanced Ht. Adjustable  Counter-balanced Ht. Adjustable	24 x 24	Static	99SQ2424X22	\$ 630	\$ 678	\$ 766
		Short Bal	99SQ2424X22BLS	1,246	1,293	1,381
	30 x 30	Static	99SQ3030X26	698	771	872
		Short Bal	99SQ3030X26BLS	1,318	1,392	1,491
	36 x 36	Static	99SQ3636X30	869	974	1,081
		Short Bal	99SQ3636X30BLS	1,837	1,941	2,049
		Count Bal	99SQ3636X30BL	1,837	1,941	2,049
	42 x 42	Static	99SQ4242X34	982	1,123	1,235
		Short Bal	99SQ4242X34BLS	1,950	2,091	2,202
		Count Bal	99SQ4242X34BL	1,950	2,091	2,202

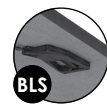
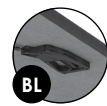

For Surge table options, please reference pages 196-199.

Top Size	Base	Model Number	3P	3K	3W	Square with Thin Square Disc Base
24 x 24	Static	99SQ2424QD16	\$ 761	\$ 809	\$ 897	    <p>Short Balanced Ht. Adjustable</p> <p>Counter-balanced Ht. Adjustable</p> <p>Thin disc bases: CH N/A SH +72 NU N/A</p>
	Short Bal	99SQ2424QD16BLS	1,439	1,486	1,574	
30 x 30	Static	99SQ3030QD16	826	898	999	
	Short Bal	99SQ3030QD16BLS	1,503	1,577	1,676	
36 x 36	Static	99SQ3636QD20	943	1,048	1,157	
	Short Bal	99SQ3636QD20BLS	1,622	1,728	1,835	
	Count Bal	99SQ3636QD20BL	1,622	1,728	1,835	
42 x 42	Static	99SQ4242QD26	1,169	1,311	1,422	
	Short Bal	99SQ4242QD26BLS	1,840	1,982	2,093	
	Count Bal	99SQ4242QD26BL	1,840	1,982	2,093	

Top Size	Base	Model Number	3P	3K	3W	Round with X-base
24 x 24	Static	99RD24X22	\$ 670	\$ 734	\$ 784	    <p>Short Balanced Ht. Adjustable</p> <p>Counter-balanced Ht. Adjustable</p>
	Short Bal	99RD24X22BLS	1,286	1,350	1,399	
30 x 30	Static	99RD30X26	761	859	908	
	Short Bal	99RD30X26BLS	1,380	1,480	1,528	
36 x 36	Static	99RD36X30	945	1,081	1,127	
	Short Bal	99RD36X30BLS	1,914	2,049	2,093	
	Count Bal	99RD36X30BL	1,914	2,049	2,093	
42 x 42	Static	99RD42X30	1,068	1,252	1,286	
	Short Bal	99RD42X30BLS	2,035	2,220	2,253	
	Count Bal	99RD42X30BL	2,035	2,220	2,253	
48 x 48	Static	99RD48X34	1,123	1,321	1,368	
	Short Bal	99RD48X34BLS	2,091	2,289	2,336	
	Count Bal	99RD48X34BL	2,091	2,289	2,336	

Top Size	Base	Model Number	3P	3K	3W	Round with thin Disc Base
24 x 24	Static	99RD24D20	\$ 801	\$ 865	\$ 914	    <p>Short Balanced Ht. Adjustable</p> <p>Counter-balanced Ht. Adjustable</p> <p>Thin disc bases: CH N/A SH +72 NU N/A</p>
	Short Bal	99RD24D20BLS	1,418	1,482	1,531	
30 x 30	Static	99RD30D20	888	986	1,035	
	Short Bal	99RD30D20BLS	1,506	1,604	1,652	
36 x 36	Static	99RD36D20	980	1,116	1,161	
	Short Bal	99RD36D20BLS	1,598	1,733	1,778	
	Count Bal	99RD36D20BL	1,598	1,733	1,778	
42 x 42	Static	99RD42D24	1,142	1,328	1,359	
	Short Bal	99RD42D24BLS	2,076	2,260	2,293	
	Count Bal	99RD42D24BL	2,076	2,260	2,293	
48 x 48	Static	99RD48D32	1,311	1,509	1,556	
	Short Bal	99RD48D32BLS	2,238	2,435	2,483	
	Count Bal	99RD48D32BL	2,238	2,435	2,483	

For Surge table options, please reference pages 196-199.

D-shaped with T-bases	Top Size	Base	Model Number	3P	3K	3W
 	24 x 36	Static	99D2436T22	\$ 845	\$ 938	\$ 1,010
		Nesting	99D2436T22NE	1,535	1,627	1,696
		Electric	99D2436T22EH	2,519	2,613	2,684
	24 x 48	Static	99D2448T22	922	1,047	1,127
		Nesting	99D2448T22NE	1,612	1,734	1,813
		Electric	99D2448T22EH	2,597	2,722	2,801
	24 x 60	Static	99D2460T22	1,001	1,158	1,245
		Nesting	99D2460T22NE	1,688	1,841	1,927
		Electric	99D2460T22EH	2,676	2,831	2,918
24 x 72	Static	99D2472T22	1,079	1,267	1,361	
	Nesting	99D2472T22NE	1,806	1,991	2,084	
	Electric	99D2472T22EH	2,753	2,940	3,035	
24 x 84	Static	99D2484T22	1,246	1,464	1,566	
	Nesting	99D2484T22NE	2,076	2,291	2,391	
24 x 90	Static	99D2490T22	1,285	1,519	1,625	
	Nesting	99D2490T22NE	2,114	2,344	2,448	
24 x 96 *	Static	99D2496T22	1,323	1,573	1,684	
	Nesting	99D2496T22NE	2,153	2,398	2,506	
30 x 48	Static	99D3048T26	1,008	1,165	1,233	
	Nesting	99D3048T26NE	1,696	1,850	1,916	
	Electric	99D3048T26EH	2,685	2,841	2,909	
30 x 60	Static	99D3060T26	1,107	1,301	1,373	
	Nesting	99D3060T26NE	1,793	1,983	2,053	
	Electric	99D3060T26EH	2,783	2,979	3,049	
30 x 72	Static	99D3072T26	1,205	1,439	1,510	
	Nesting	99D3072T26NE	1,930	2,159	2,231	
	Electric	99D3072T26EH	2,881	3,115	3,187	
30 x 84	Static	99D3084T26	1,390	1,665	1,737	
	Nesting	99D3084T26NE	2,218	2,487	2,558	
30 x 90	Static	99D3090T26	1,440	1,732	1,806	
30 x 96 *	Static	99D3096T26	1,488	1,800	1,877	
36 x 48	Static	99D3648T26	1,087	1,274	1,332	
	Nesting	99D3648T26NE	1,773	1,957	2,013	
	Electric	99D3648T26EH	2,763	2,951	3,008	

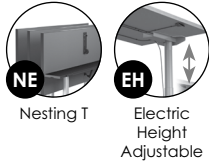

surge

* \$200 NET surcharge per order for oversized pallet

For Surge table options, please reference pages 196-199.

Top Size	Base	Model Number	3P	3K	3W	D-shaped with T-bases
36 x 60	Static	99D3660T26	\$1,205	\$1,439	\$1,491	
	Nesting	99D3660T26NE	1,978	2,208	2,260	
	Electric	99D3660T26EH	2,881	3,115	3,167	
36 x 72	Static	99D3672T26	1,321	1,603	1,651	
	Nesting	99D3672T26NE	2,211	2,486	2,534	
	Electric	99D3672T26EH	2,997	3,279	3,328	
36 x 84	Static	99D3684T26	1,527	1,856	1,901	
36 x 90	Static	99D3690T26	1,586	1,938	1,980	
36 x 96 *	Static	99D3696T26	1,645	2,020	2,061	

Top Size	Base	Model Number	3P	3K	3W	D-shaped with 2 Disc Bases
24 x 60	Static	99D2460D20	\$1,606	\$1,762	\$1,850	
24 x 72	Static	99D2472D20	1,685	1,872	1,967	
24 x 84	Static	99D2484D20	1,851	2,069	2,172	
24 x 90	Static	99D2490D20	1,889	2,125	2,231	
24 x 96 *	Static	99D2496D20	1,929	2,179	2,288	
30 x 60	Static	99D3060D20	1,705	1,900	1,969	
30 x 72	Static	99D3072D20	1,801	2,036	2,108	
30 x 84	Static	99D3084D20	1,988	2,261	2,335	
30 x 90	Static	99D3090D20	2,036	2,329	2,404	
30 x 96 *	Static	99D3096D20	2,085	2,398	2,473	
36 x 72	Static	99D3672D24	2,000	2,281	2,330	
36 x 84	Static	99D3684D24	2,205	2,533	2,578	
36 x 90	Static	99D3690D24	2,264	2,616	2,659	
36 x 96 *	Static	99D3696D24	2,323	2,698	2,739	
42 x 72	Static	99D4272D32	2,615	3,035	2,992	
42 x 84	Static	99D4284D32	2,737	3,168	3,147	
42 x 90	Static	99D4290D32	2,813	3,278	3,248	
42 x 96 *	Static	99D4296D32	2,891	3,386	3,349	

* \$200 NET surcharge per order for oversized pallet

For Surge table options, please reference pages 196-199.

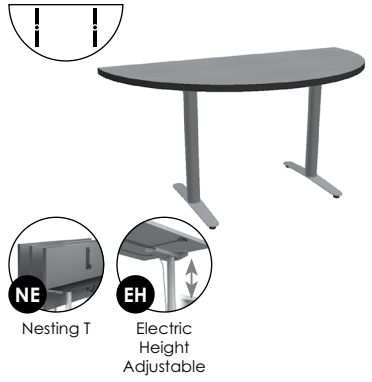
Half Round with T-bases	Top Size	Base	Model Number	3P	3K	3W
 <p>NE Nesting T</p> <p>EH Electric Height Adjustable</p>	30 x 60	Static	99HR3060T22	\$ 1,100	\$ 1,296	\$ 1,350
		Nesting	99HR3060T22NE	1,785	1,978	2,029
		Electric	99HR3060T22EH	2,775	2,971	3,023
	36 x 72	Static	99HR3672T26	1,320	1,601	1,630
		Nesting	99HR3672T26NE	2,133	2,409	2,438
		Electric	99HR3672T26EH	2,996	3,276	3,306

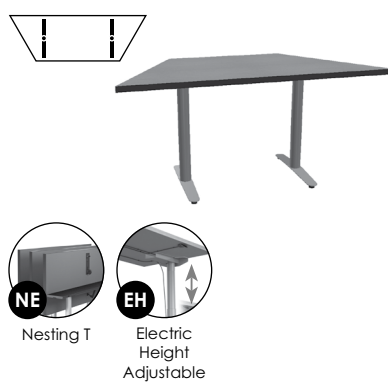
Trapezoid with T-bases	Top Size	Base	Model Number	3P	3K	3W
 <p>NE Nesting T</p> <p>EH Electric Height Adjustable</p>	30 x 60	Static	99TZ3060T22	\$ 1,048	\$ 1,224	\$ 1,292
		Nesting	99TZ3060T22NE	1,734	1,906	1,973
		Electric	99TZ3060T22EH	2,723	2,898	2,967
	36 x 72	Static	99TZ3672T26	1,292	1,562	1,600
		Nesting	99TZ3672T26NE	2,107	2,370	2,408
		Electric	99TZ3672T26EH	2,958	3,228	3,266







For Surge table options, please reference pages 196-199.

For Surge table options, please reference pages 196-199.

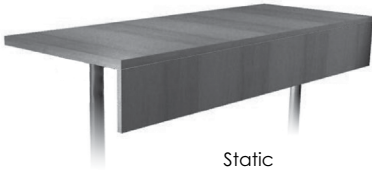
table~~x~~

AC accessories
price list
Effective January 1, 2023



Laminate Modesty Panels	Top Size	Base	Model Number	Hardware	3P	3W
	10 x 36	Static	MP1036	02 Black	145	275
		Nesting	MP1036NE	02 Black	240	368
	10 x 48	Static	MP1048	02 Black	174	336
		Nesting	MP1048NE	02 Black	268	430
		Static	MP1060	02 Black	202	397
	10 x 60	Folding	MP1060FD	02 Black	369	565
		Nesting	MP1060NE	02 Black	297	493
		Static	MP1072	02 Black	246	475
	10 x 72	Folding	MP1072FD	02 Black	396	627
		Nesting	MP1072NE	02 Black	324	555
		Static	MP1084	02 Black	273	538
	10 x 84	Folding	MP1084FD	02 Black	523	788
		Nesting	MP1084NE	02 Black	414	679
		Static	MP1090	02 Black	317	600
	10 x 90	Folding	MP1090FD	02 Black	552	834
		Nesting	MP1090NE	02 Black	444	725
		Static	MP1096	02 Black	317	615
	10 x 96 *	Folding	MP1096FD	02 Black	552	850
		Nesting	MP1096NE	02 Black	444	741

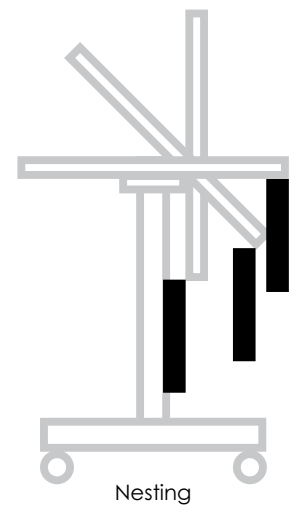
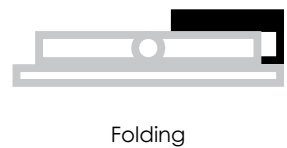

accessories

* \$200 NET surcharge per order for oversized pallet

Top Size	Base	Model Number	Hardware		Price	Frosted Acrylic Modesty Panels
10 x 36	Static or Nesting	MAP1036	-BL	-SV	389	
10 x 48	Static or Nesting	MAP1048	-BL	-SV	433	
10 x 60	Static or Nesting	MAP1060	-BL	-SV	478	
10 x 66	Static or Nesting	MAP1066	-BL	-SV	500	
10 x 72	Static or Nesting	MAP1072	-BL	-SV	522	
10 x 84	Static or Nesting	MAP1084	-BL	-SV	678	
10 x 90	Static or Nesting	MAP1090	-BL	-SV	722	
10 x 96 *	Static or Nesting	MAP1096	-BL	-SV	722	

Top Size	Basez	Model Number	Finish	Price	Perforated Metal Modesty Panels
9 x 48	Static or Nesting	MMP948	Powdercoated	514	
9 x 60	Static or Nesting	MMP960	Powdercoated	544	
9 x 72	Static or Nesting	MMP972	Powdercoated	574	

Top Size	Base	Model Number	Color	Price	Mesh Modesty Panels
10 x 36	Static or Nesting	MSP1036	Black mesh	264	
10 x 48	Static or Nesting	MSP1048	Black mesh	277	
10 x 60	Static or Nesting	MSP1060	Black mesh	292	
10 x 72	Static or Nesting	MSP1072	Black mesh	305	
10 x 84	Static or Nesting	MSP1084	Black mesh	321	
10 x 90	Static or Nesting	MSP1090	Black mesh	325	
10 x 96 *	Static or Nesting	MSP1096	Black mesh	331	

* \$200 NET surcharge per order for oversized pallet

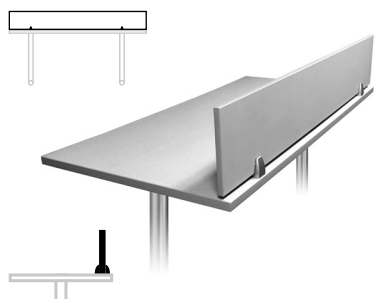
Laminate Privacy Panels	Top Size	Base	Model Number	Hardware	3P	3W
	10 x 36	Static	PP1036	Silver	\$ 231	\$ 361
	10 x 48	Static	PP1048	Silver	260	423
	10 x 60	Static	PP1060	Silver	287	483
	10 x 72	Static	PP1072	Silver	317	545
	10 x 84	Static	PP1084	Silver	403	666
	10 x 90	Static	PP1090	Silver	430	712
	10 x 96 *	Static	PP1096	Silver	430	728

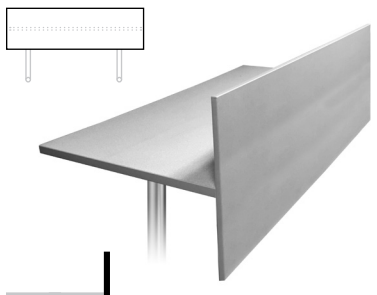
Extended Laminate Privacy Panels	Top Size	Base	Model Number	Hardware	3P	3W
	22 x 36	Static	EPP2236	02 Black	\$ 300	\$ 469
	22 x 48	Static	EPP2248	02 Black	357	562
	22 x 60	Static	EPP2260	02 Black	385	623
	22 x 72	Static	EPP2272	02 Black	434	709
	22 x 84	Static	EPP2284	02 Black	580	895
	22 x 90	Static	EPP2290	02 Black	637	974
	22 x 96 *	Static	EPP2296	02 Black	637	989

* \$200 NET surcharge per order for oversized pallet

Top Size	Base	Model Number	Hardware	Price	Frosted Acrylic Privacy Panels
10 x 36	Static	PAP1036	Silver	\$ 283	
10 x 48	Static	PAP1048	Silver	327	
10 x 60	Static	PAP1060	Silver	371	
10 x 72	Static	PAP1072	Silver	415	
10 x 84	Static	PAP1084	Silver	519	
10 x 90	Static	PAP1090	Silver	563	
10 x 96 *	Static	PAP1096	Silver	563	

Top Size	Base	Model Number	Hardware	Price	Extended Acrylic Privacy Panels
22 x 36	Static	EPAP2236	Chrome	\$ 393	
22 x 48	Static	EPAP2248	Chrome	477	
22 x 60	Static	EPAP2260	Chrome	560	
22 x 72	Static	EPAP2272	Chrome	644	
22 x 84	Static	EPAP2284	Chrome	776	
22 x 90	Static	EPAP2290	Chrome	818	
22 x 96 *	Static	EPAP2296	Chrome	859	

* \$200 NET surcharge per order for oversized pallet

Metal Pop-up Units

Each of our metal pop-up units feature a single touch door opening which closes when not in use. These units are available in a multitude of configurations balancing your need for conventional (15 amp/125 volt) power with USB power and data jacks. **When ordering electrical components on pages 218-225, it is the responsibility of the customer to ensure the components selected meet local electrical codes.**

Finishes: Choose between Black and Anodized Aluminum.

Cord: Choose between 72" and 120" length. All feature 15 amp/125 volt. Some units require two cords.

Cutout: You do not need to specify a grommet or add any upcharge to your table price. The cost of the cutout is included in the price of the unit.

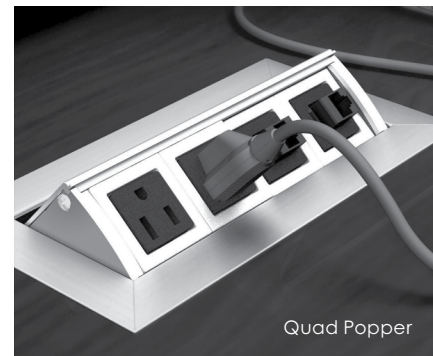

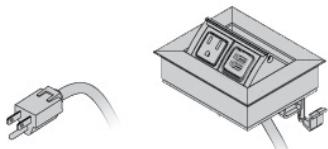
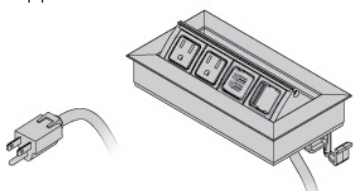
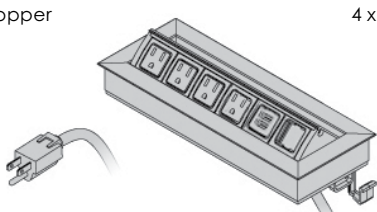
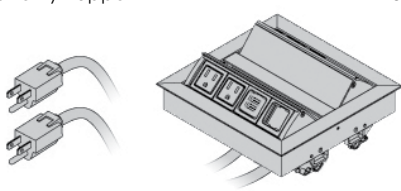
Product	Approx. Size	Configuration	Cord	Model Number	BL	AA
 Twin Popper	4 x 5"	2 Power	72"	PD04-2P-72	269	NA
			120"	PD04-2P-120	280	NA
		1 Power + 1 KO	72"	PD04-1P-1D-72	256	NA
			120"	PD04-1P-1D-120	267	NA
		1 Power + 2 USB	72"	PD04-1P-2U-72	360	NA
			120"	PD04-1P-2U-120	371	NA
 Quad Popper	4 x 8"	4 Power	72"	PD06-4P-72	627	491
			120"	PD06-4P-120	638	501
		2 Power + 2 KO	72"	PD06-2P-2D-72	498	391
			120"	PD06-2P-2D-120	509	403
		2 Power + 2 USB + 1 KO	72"	PD06-2P-2U-72	602	496
			120"	PD06-2P-2U-120	614	507
 Hex Popper	4 x 11"	6 Power	72"	PD14-6P-72	746	585
			120"	PD14-6P-120	758	596
		3 Power + 3 KO	72"	PD14-3P-3D-72	556	438
			120"	PD14-3P-3D-120	567	449
		4 Power + 2 USB + 1 KO	72"	PD14-4P-2U-72	774	630
			120"	PD14-4P-2U-120	785	641
 Butterfly Popper	8 x 8"	8 Power	72"	PD08-8P-72	1,165	905
			120"	PD08-8P-120	1,187	927
		4 Power + 4 KO	72"	PD08-4P-4D-72	994	772
			120"	PD08-4P-4D-120	1,016	794
		4 Power + 4 USB + 2 KO	72"	PD08-4P-4U-72	1,203	981
			120"	PD08-4P-4U-120	1,225	1,003

Where would you like your power units?

For custom locations, please provide a drawing with your order.

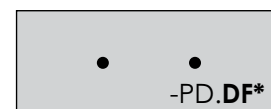
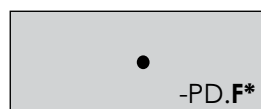
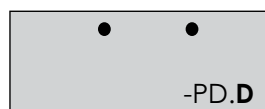
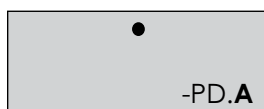

***NOTE:** Locations -PD.F & -PD.DF are NOT available on hand crank or nesting tables.

Plastic Units

These units are designed with an eye on the fixed budget. They are available in a multitude of configurations balancing your need for conventional (15 amp/125 volt) power with USB power and data jacks.

Finishes: Choose between Black and White. Other finishes are available for those units marked with "#". Contact TableX customer service for options and pricing.

Cord: Choose between 72" and 120" length. All feature 15 amp/125 volt.

Cutout: You do not need to specify a grommet or add any upcharge to your table price. The cost of the cutout is included in the price of the unit.



Product	Approx. Size	Configuration	Cord	Model Number	Color	List
	3.75" round	3 Power	72"	PD17-3P-72	-BL -WH -#	189
			120"	PD17-3P-120	-BL -WH -#	200
		2 Power + 1 USB	72"	PD17-2P-1U-72	-BL -WH -#	273
			120"	PD17-2P-1U-120	-BL -WH -#	284
	5" round	3 Power	72"	PD16-3P-72	-BL -WH	252
			120"	PD16-3P-120	-BL -WH	264
		2 Power + 1 USB	72"	PD16-2P-1U-72	-BL -WH	347
			120"	PD16-2P-1U-120	-BL -WH	357
	2.75 x 7.313 x 2.063"	4 Power	72"	PD18-CO-4P-72	-BL -WH	317
			120"	PD18-CO-4P-120	-BL -WH	328
		2 Power + 2 USB	72"	PD18-CO-2P-2U-72	-BL -WH	388
		+ 1 KO	120"	PD18-CO-2P-2U-120	-BL -WH	399
	3.75 x 7.625 x 1.75"	2 Power + 1 Dual USB-A+C Port + Qi Wireless Charger	108"	PD19-108	-BL -WH	320

Additional Outlet Options	Description	Model Number	List
HDMI	- Fits into blank data knockouts with 18" cord	B-HDMI	116
RJ45/Cat 6	- Fits into blank data knockouts with 120" cord	B-RJ45	123

p 218-219: Unless specified on order, all USB configurations will be an A+C USB Dual Port.

Villa™ Daisylink™ System

The Villa Daisylink system is a 4 wire, 2 circuit hardwire system which allows for non-sequential plug and play use. Link up to 20 single kits or 10 double kits in a row using one of three power infeed options.

Grommet holes are pre-routed in the top, and each unit comes with a flush grommet cover.

3 finishes available:

- BL: Black grommet, black body
- SV: Silver grommet, silver body
- WH: White grommet, black body

Infeeds: You must specify a power infeed unit for each row or grouping of tables. The number of kits that can be supported per row varies depending on the infeed specified.



- Single Kit includes:**
- 1 Villa power base
 - 1 FM cable
 - 1 FF cable
 - 4 cable clamps
 - 1 grommet (on -L / -F models)



- Double Kit includes:**
- 2 Villa power bases
 - 1 FM cable
 - 2 FF cable
 - 6 cable clamps
 - 2 grommets (on -L / -F models)

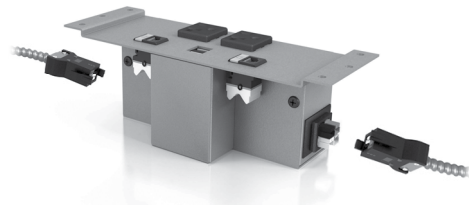

How Does the Villa Daisylink System Work?

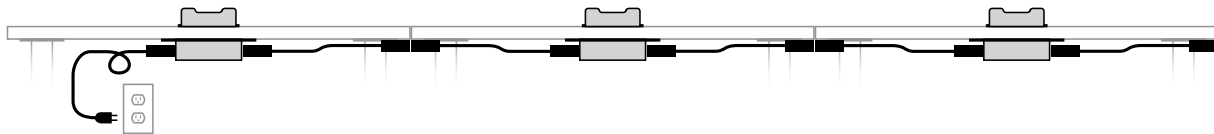



Daisylink Accessories	Description	Visual	Cord	Model Number	Price
<p>20/15 AMP Plug Infeed</p>	- 20 AMP outlet with standard 15 AMP adapter can be plugged into any standard wall outlet. - Feeds up to 10 units. - 20 total receptacles		72	VAP-72	\$220
<p>Hardwire Infeed</p>	- 2 circuit system hardwired into wall and plugs into first table in the row. - Feeds up to 20 units.		72	VHW-72	175
<p>Quick Disconnect Kit</p>	- Hardwired wall unit paired with an FF jumper unit which plugs into first table in the row. - Feeds up to 20 units.		72	VQD-72	292
<p>FM Jumper Unit</p>	- Great for linking tables around a corner, face to face, bypassing a non-powered table, or two tables that are not in perfect alignment.		12 24 36 48 60 72	VFM-12 VFM-24 VFM-36 VFM-48 VFM-60 VFM-72	95 112 129 147 163 181
<p>Splitter</p>	- Splits power to feed tables running in different directions			VT-MFM	151

accessories

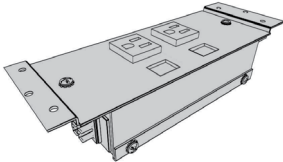
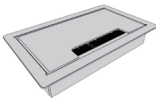
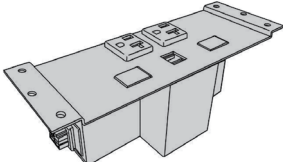
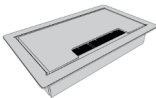
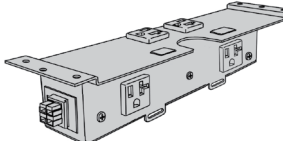
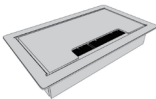
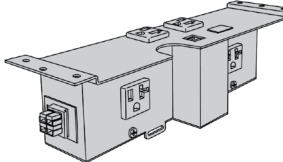
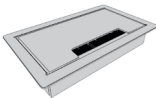
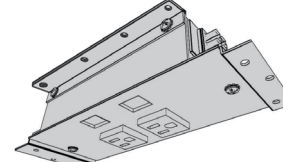
Single Villa Kits	Double Villa Kits
-------------------	-------------------

Villa Daisylink Kits	Grommet Cover	Table Size	Model No.	List	Model No.	List
		36"	V36SP-2P	443	NA	NA
		48"	V48SP-2P	443	NA	NA
		60"	V60SP-2P	443	V60DP-2P	809
		72"	V72SP-2P	443	V72DP-2P	809
		84"	V84SP-2P	NA	V84DP-2P	809
		90"	V90SP-2P	NA	V90DP-2P	NA
		96"	V96SP-2P	NA	V96DP-2P	809
		36"	V36SP-2P-1U	587	NA	NA
		48"	V48SP-2P-1U	587	NA	NA
		60"	V60SP-2P-1U	587	V60DP-2P-1U	1,098
		72"	V72SP-2P-1U	587	V72DP-2P-1U	1,098
		84"	V84SP-2P-1U	NA	V84DP-2P-1U	1,098
		90"	V90SP-2P-1U	NA	V90DP-2P-1U	NA
		96"	V96SP-2P-1U	NA	V96DP-2P-1U	1,098
		36"	V36SP-2P-2C	515	N/A	NA
		48"	V48SP-2P-2C	515	N/A	NA
		60"	V60SP-2P-2C	515	V60DP-2P-2C	860
		72"	V72SP-2P-2C	515	V72DP-2P-2C	860
		84"	V84SP-2P-2C	NA	V84DP-2P-2C	860
		90"	V90SP-2P-2C	NA	V90DP-2P-2C	NA
		96"	V96SP-2P-2C	NA	V96DP-2P-2C	NA
		36"	V36SP-2P-1U-2C	659	N/A	NA
		48"	V48SP-2P-1U-2C	659	N/A	NA
		60"	V60SP-2P-1U-2C	659	V60DP-2P-1U-2C	1,148
		72"	V72SP-2P-1U-2C	659	V72DP-2P-1U-2C	1,148
		84"	V84SP-2P-1U-2C	NA	V84DP-2P-1U-2C	1,148
		90"	V90SP-2P-1U-2C	NA	V90DP-2P-1U-2C	NA
		96"	V96SP-2P-1U-2C	NA	V96DP-2P-1U-2C	1,148
	None	36"	V36SP-2C	500	NA	NA
		48"	V48SP-2C	500	NA	NA
		60"	V60SP-2C	500	V60DP-2C	663
		72"	V72SP-2C	500	V72DP-2C	663
		84"	V84SP-2C	500	V84DP-2C	663
		90"	V90SP-2C	NA	V90DP-2C	NA
		96"	V96SP-2C	500	V96DP-2C	663

Villa Accessories	Description	Model Number	List
 Villa RJ45 Data Keystone	- Fits into blank data knockouts	V-RJ45	68
 Villa HDMI Keystone	- Fits into blank data knockouts	V-HDMI	72

"Villa" and "Daisylink" are trademarks of Dekko.

Cove™ Daisylink™ System

The Cove Daisylink system is a 4 wire, 2 circuit hardwire system which allows for non-sequential plug and play use. Link up to 20 single kits or 10 double kits in a row using one of three power infeed options.

Grommet holes are pre-routed in the top. All outlets and body of unit is black.

3 face plate finishes available:

- BL: Black
- SV: Silver
- WH: White

Infeeds: You must specify a power infeed unit for each row or grouping of tables. The number of kits that can be supported per row varies depending on the infeed specified.



Single Kit includes:

- 1 Cove power base
- 1 FM cable
- 1 FF cable
- 4 cable clamps
- 1 grommet (on -L / -F models)



Double Kit includes:

- 2 Cove power bases
- 1 FM cable
- 2 FF cable
- 6 cable clamps
- 2 grommets (on -L / -F models)





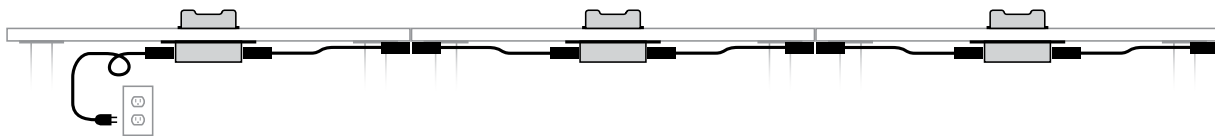



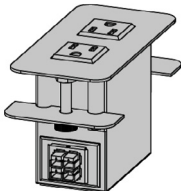

How Does the Cove Daisylink System Work?

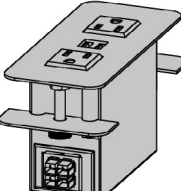

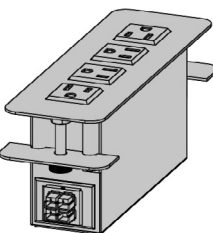
Daisylink Accessories	Description	Visual	Cord	Model Number	Price
20/15 AMP Plug Infeed 	- 20 AMP outlet with standard 15 AMP adapter can be plugged into any standard wall outlet. - Feeds up to 10 units.		72	VAP-72	\$220
Hardwire Infeed 	- 2 circuit system hardwired into wall and plugs into first table in the row. - Feeds up to 20 units.		72	VHW-72	175
Quick Disconnect Kit 	- Hardwired wall unit paired with an FF jumper unit which plugs into first table in the row. - Feeds up to 20 units.		72	VQD-72	292
FM Jumper Unit 	- Great for linking tables around a corner, face to face, bypassing a non-powered table, or two tables that are not in perfect alignment.		12 24 36 48 60 72	VFM-12 VFM-24 VFM-36 VFM-48 VFM-60 VFM-72	95 112 129 147 163 181
Splitter 	- Splits power to feed tables running in different directions			VT-MFM	151

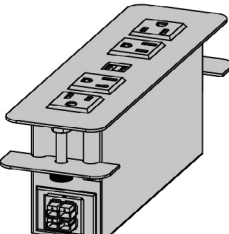
Single Cove Kits	Double Cove Kits
------------------	------------------

Cove Daisylink Kits	Face Plate	Table Size	Model No.	List	Model No.	List
2 Power 	2.5 x 5" 	36"	C36SP-2P	482	NA	NA
		48"	C48SP-2P	482	NA	NA
		60"	C60SP-2P	482	C60DP-2P	845
		72"	C72SP-2P	482	C72DP-2P	845
		84"	C84SP-2P	NA	C84DP-2P	845
		96"	C96SP-2P	NA	C96DP-2P	845
2 Power + 2 USB 	2.5 x 5.75" 	36"	C36SP-2P-2U	627	NA	NA
		48"	C48SP-2P-2U	627	NA	NA
		60"	C60SP-2P-2U	627	C60DP-2P-2U	1,129
		72"	C72SP-2P-2U	627	C72DP-2P-2U	1,129
		84"	C84SP-2P-2U	NA	C84DP-2P-2U	1,129
		96"	C96SP-2P-2U	NA	C96DP-2P-2U	1,129
4 Power 	2.5 x 7.75" 	36"	C36SP-4P	696	NA	NA
		48"	C48SP-4P	696	NA	NA
		60"	C60SP-4P	696	C60DP-4P	1,270
		72"	C72SP-4P	696	C72DP-4P	1,270
		84"	C84SP-4P	NA	C84DP-4P	1,270
		96"	C96SP-4P	NA	C96DP-4P	1,270
4 Power + 2 USB 	2.5 x 8.75" 	36"	C36SP-4P-2U	840	NA	NA
		48"	C48SP-4P-2U	840	NA	NA
		60"	C60SP-4P-2U	840	C60DP-4P-2U	1,555
		72"	C72SP-4P-2U	840	C72DP-4P-2U	1,555
		84"	C84SP-4P-2U	NA	C84DP-4P-2U	1,555
		96"	C96SP-4P-2U	NA	C96DP-4P-2U	1,555

Villa™ Corded System

This system is built with easy plug-and-play capabilities and reconfiguration in mind. Each table can be plugged into the wall separately or can be piggy-backed off of the next table. (Max of 6 units in any run.)

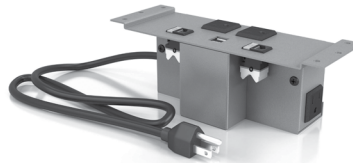

- 3 finishes available:**
- BL: Black grommet, black body
 - SV: Silver grommet, silver body
 - WH: White grommet, black body

Grommet holes are pre-routed in the top, and each unit comes with a flush grommet cover.

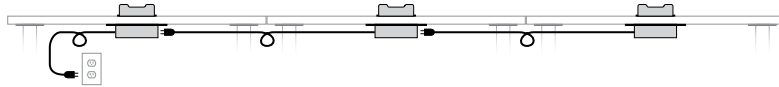

How Does the Villa Corded System Work?

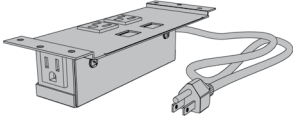
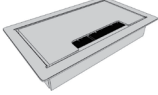
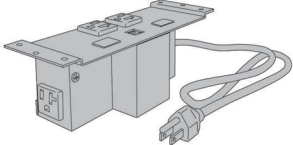
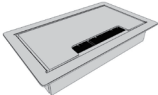
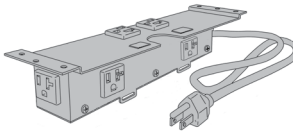
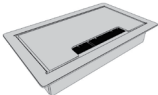
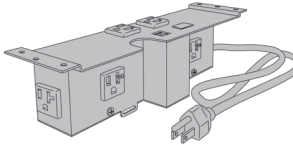
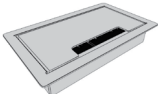
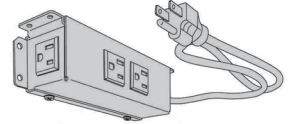

Villa Corded Units	Grommet Cover	Model Number	Cord	Color	List
2 Power + 1 Convenience + 2 KO 	3.25 x 5.5" Flush 	VC-2P-1C-_-_-	-36 -72 -108	-BL -SV	\$ 321
2 Power + 2 USB + 1 Convenience + 2 KO 	3.25 x 5.5" Flush 	VC-2P-2U-1C-_-_-	-36 -72 -108	-BL -SV	\$ 466
2 Power + 3 Convenience + 2 KO 	3.25 x 5.5" Flush 	VC-2P-3C-_-_-	-36 -72 -108	-BL -SV	\$ 373
2 Power + 2 USB + 3 Convenience + 1 KO 	3.25 x 5.5" Flush 	VC-2P-2U-3C-_-_-	-36 -72 -108	-BL -SV	\$ 510
3 Convenience Undermount 	None	VC-3C-_-_-	-36 -72 -108	-BL -SV	\$ 230
Villa Accessories	Description	Model Number	List		
Villa RJ45 Data Keystone 	- Fits into blank data knockouts	V-RJ45	68		
Villa HDMI Keystone 	- Fits into blank data knockouts	V-HDMI	72		

Cove™ Corded System

Smooth access to power and USB power that runs flush to the table top.

Some models are available with convenience outlets to allow table to be piggy-backed off of the next table. (Max of 6 units in any run.)

Grommet holes are pre-routed in the top. All outlets and body of unit is black.



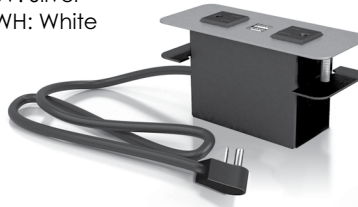

3 face plate finishes available:



- BL: Black
- SV: Silver
- WH: White





Cove Corded Units	Face Plate	Specs	Model Number	Color	List
	 2.5 x 5"	Rectangle	CC108-2P	-BL -SV	\$ 322
	 6"	Round	CC108-2P-RD	-BL -SV	\$ 322
	 2.5 x 5.75"	Rectangle +1 Convenience	CC108-2P-1C	-BL -SV	\$ 344
	 6"	Rectangle +2 Convenience	CC108-2P-2U	-BL -SV	\$ 461
	 2.5 x 7.75"	Rectangle +2 Convenience	CC108-2P-2U-2C	-BL -SV	\$ 607
		 2.5 x 7.75"	Rectangle	CC108-4P	-BL -SV
	 2.5 x 8.75"	Rectangle	CC108-4P-2U	-BL -SV	\$ 579
		 2.5 x 10.75"	Rectangle	CC108-6P	-BL -SV
	 2.5 x 13.25"	Rectangle	CC108-6P-4U	-BL -SV	\$ 769

"Cove" is a trademark of Dekko.

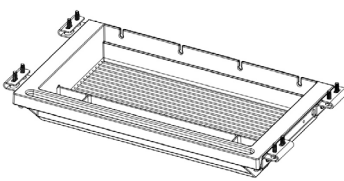
Product	Description	Length	Model Number	Color	Price
Built-in Wire Management Leg 	1 x 19" steel hinged access door built into one base. Door runs within 2.5" of top plate and bottom of base. Door height varies depending on series and options. Not available on all series. Check series intro for compatibility.	N/A	-WM	matches base color	+ \$139 - - -
Snap-on Wire Management Leg Cover 	Snaps on to round columns and offers coverage of wires down the leg. Check series intro for compatibility. Powdercoated steel to match base color (not available in chrome). Available for 2" and 3" columns.	N/A	-WMLC.2 -WMLC.3	matches base color	50 79 - -
Magnetic Wire Management Leg Cover 	Magnetically attaches to rectangular and square bases, offering coverage of wires down the leg. Check series intro for compatibility. Powdercoated steel to match base color.	N/A	-MMLC	matches base color	71 - - -
Vertical Spine Management 3 x 1.5 	Oval spine conceals and carries wires from under desk to floor. Single channel on each side to keep cords separate where code requires. Screws to under side of worksurface with weighted base. Available in Silver Metallic.	30" 42"	WMH WMH-SH	Silver Silver	174 241 - -
J-Channel Management 3.25 x 1" 	Ideal when cords need to be moved often. Can be attached to underside of the table or to a modesty panel. Self adhesive tape applied for easy installation. Black plastic.	12" 36" 60" 72"	WMA1 WMA3 WMA5 WMA6	Black Black Black Black	108 139 191 205 -
Wave Cable Gripper 5.75" x 1.75" 	This cable manager features an intelligent design that allows wires to slip into the unit. Place these grips anywhere you need to get wires under control. Simple to install with only two screws, users can easily move to different positions as their work environment changes.	N/A	CG4	Black	18

Product	Description	Length	Model Number	Color	Price
Vertebrae Management 3.125 x 1" 	Contains four separate channels. Two main channels and two smaller which allow wires to sit in a .5" trough. Black plastic.	36"	WMD3	Black	\$ 114
Grommet 2.75 x 2.75" 	Add grommets to any table top for \$45 each. Use chart below to select grommet location. For example, add "-GR.D" at the end of the model number for a table needing two grommets in location D and add \$89 to the list price. Black plastic.	N/A	-GR._ _	Black	45 ea.
MINI Drawer 13.6"w x 8"d x 2"h 	A thin-profile, non-locking drawer with ball bearing slides designed to fit underneath work surfaces, especially height-adjustable tables. The MINI drawer is only 8" in depth and features a tray that can slide across the drawer and can also be removed and placed on the work surface to hold accessories or personal items. The tray also allows for easy-access storage inside the drawer. Wire management slots on the backside of the MINI allow the user to place items such as their mobile phone inside and then draw the charging cord out the back.	N/A	-MD	Black	104

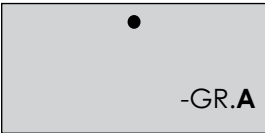
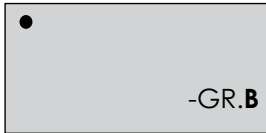
Where Would You Like Your Grommets? For custom locations, please provide a drawing with your order.

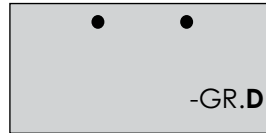
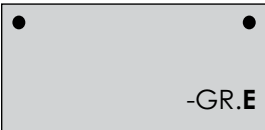
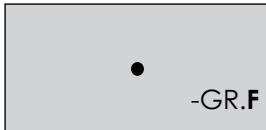
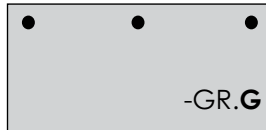
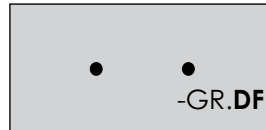
 -GR.A	 -GR.B	 -GR.C	 -GR.D
 -GR.E	 -GR.F	 -GR.G	 -GR.DF

Please note: GR.F and GR.DF are NOT available on nesting tables

accessories