



TableX Customer Service:
877.481.1177
sales@tablex.com

Welcome to our October 2023 TableX price list. We have made a number of important product additions and several deletions to this most recent price book update. Please confirm you have the most current TableX product details and list prices by visiting: www.tablex.com/pricing.

If you have any questions, or need something above and beyond the standard solutions shown in this book, please don't hesitate to contact us. We welcome custom requests and are here to help you.

Introduction	Page
Pricing Comparison	p. 2
Terms & Conditions	p. 4
<ul style="list-style-type: none"> • Pricing • Orders • Order Acknowledgements • Terms • Lead Times • Modified Product • Cancellations & Returns 	
Freight	p. 5
<ul style="list-style-type: none"> • Freight Charges • Shipping 	
Sample Purchase Order	p. 6
Warranty	p. 7
Surface Materials	p. 8
<ul style="list-style-type: none"> • High Pressure Laminates • Powdercoat Base Colors • 3mm PVC Edges • 3mm PVC Knife Edges • Wood Edges (3mm only) • Coordinating Finishes 	
Table Options	p. 12
<ul style="list-style-type: none"> • Nesting Tables • Folding Tables • Flip Top Tables • Folding Tables • Top Options • Base Options • Custom Height Options • Height Adjustable Options 	
Seating Capacities	p. 20

Product Pricing	Page
TableXpress Quickship Program	p. 22
00 - Ultra Series	p. 28
01 - Foundation Series	p. 36
02 - Fundamental Series	p. 52
06 - Stretch Series	p. 68
08 - Elite Series	p. 84
09 - Revel Series	p. 102
17 - App Series	p. 106
33 - Element Series	p. 110
40 - Justice Series	p. 124
43 - Artisan Series	p. 132
44 - Primary Series	p. 138
45 - Puddle Series	p. 144
71 - Exclaim Series	p. 164
74 - VertiGo Series	p. 174
99 - Surge Series	p. 194
Table Accessories	p. 212
<ul style="list-style-type: none"> • Modesty Panels • Privacy Panels 	
Power / Data	p. 218
<ul style="list-style-type: none"> • Metal Pop-up Units • Budget Units • Daisylink Systems • Corded Systems 	
Wire Management	p. 226

24x60" Rectangles

Something as simple as a 24x60" rectangular table can be specified many different ways. With 12 different standard series of bases, TableX has you covered. Use the matrix below to compare list pricing of each series, using a static, 24x60" rectangular table with a 3P (3mm PVC) edge.



Ultra
p.32

\$1,107 List

Foundation
p.40

\$793

Fundamental
p.56

\$784

Stretch
p.72

\$839

Elite
p.88

\$985

Revel
p.105

\$929

Element
p.114

\$839

Justice
p.128

\$1,342

Artisan
p.136

\$1,680

Primary
p.136

four columns
\$900

Primary
p.137

two 44 discs
\$1,799

Puddle
p.158

two 45 discs
\$1,562

Exclaim
p.164

\$1,102

VertiGo
p.181

\$876

Surge
p.200

\$929

Surge
p.202

two 99 discs
\$1,491

36" Rounds

Cafe and lounge tables are being utilized everywhere. TableX offers a wide variety of bases that give you plenty of choices. Use the matrix below to compare list pricing of each series, using a static, 36" round table with a 3P (3mm PVC) edge.



<p>Foundation p.47</p> <p>\$828 List</p>	<p>Fundamental p.63</p> <p>\$791</p>	<p>Stretch p.79</p> <p>\$1,037</p>	<p>Elite p.97</p> <p>\$996</p>
<p>Element p.119</p> <p>\$1,003</p>	<p>Primary p.149</p> <p>four columns \$895</p>	<p>Primary p.149</p> <p>44 disc \$1,172</p>	<p>Puddle p.159</p> <p>45 disc \$1,053</p>
<p>VertiGo p.189</p> <p>\$1,044</p>	<p>VertiGo p.189</p> <p>74 disc \$1,057</p>	<p>Surge p.207</p> <p>\$1,005</p>	<p>Surge p.207</p> <p>99 disc \$1,018</p>

Pricing

All prices quoted are list prices, FOB our warehouse. All documentation and literature is based on the most recent information available at the time of this publication. We reserve the right to make product improvements and design enhancements at any time, without notice. Prices are subject to change without notification.

Orders

All orders must be received in writing with complete information. See page 6 for a sample purchase order and a checklist of information that is required to place an order.

E-mail orders to:
sales@tablex.com

Fax orders to:
812.481.1178

Duplicate orders that are not marked as such are the responsibility of the customer.

Order Acknowledgements

Orders are acknowledged upon receipt at TableX. No order shall be binding upon TableX until we confirm it with an acknowledgement. The customer bears sole responsibility for order correctness. All orders will be manufactured and invoiced in accordance with the acknowledgement. Customers must notify TableX in writing of any discrepancy **within 5 days**. Any subsequent change order is dependent upon our ability to accommodate the specification, terms and status of the order in production, and may be subject to additional charges for labor, material and other costs involved.

Terms

Terms are Net 30 days from the date of invoice. Payment is due when invoice is issued and is considered delinquent if not paid within 30 days. Interest will be charged at the rate of 1.5% per month on delinquent accounts. TableX does not create or provide statements.

Lead Times

Lead times can vary based on product availability, fluctuations in busy season, and national holidays. Please contact customer service at 877.481.1177 for current lead times.

Note: Selecting certain options (3mm wood edges, chrome bases, or solid surface tops) can impact lead time. Below are estimated lead times based on normal business conditions.

Laminate	Edge	Base	Standard Lead Time
TableXpress Program			7-10 day quickship
standard	3mm PVC	standard	4-5 weeks
solid surface tops			4-6 weeks
	3mm wood		6-8 weeks
		chrome	10 weeks

Modified Product

TableX prides itself on providing you with product that exceeds your expectations. Sometimes your needs are outside the standard product offering. Our flexibility as a smaller company allows us to accommodate requests for non-cataloged product. Contact Customer Service at 877.481.1177 to discuss your unique product requirements and we'll help you meet your needs.

Cancellations & Returns

Our acceptance of an order is final and binding and not subject to cancellation by the customer. No merchandise may be returned without the written consent of TableX. When ordering electrical components on pages 218-227, it is the responsibility of the customer to ensure the components selected meet local electrical codes. Electrical components are made-to-order and cannot be returned.

Freight Charges

TableX is located in Jasper, Indiana. All shipping zones are based on proximity to our facility.

Minimum Orders

Standard freight charges apply to any order under \$3,000 total list price shipping within the continental United States. The standard charge for each zone is shown below, based on the total list price of the order.

Tiered Freight Program

These freight charges are reduced or waived on orders based on their total list price. The qualifying list prices for each zone are shown below.

Shipping

All shipments are F.O.B., dock-to-dock from our warehouse. Charges for additional services such as lift gates, non-commercial deliveries, inside deliveries, oversized pallets (pallets used for single table tops 90" or longer), and call before delivery are the responsibility of the buyer and may be charged to the buyer after the date of delivery.

Legal responsibility for the product transfers to the buyer upon acceptance by the carrier. Damaged, lost or shorted shipments are the responsibility of the carrier. Inspect all shipments promptly upon arrival and note any damage or loss on the delivery receipt. If damage is concealed, keep the packing and notify the carrier immediately for an inspection. Carriers require such reports within 5 days of delivery. Failure to report damage or loss is the consignee's responsibility. The freight charges may be collect to the receiver, billed to the purchaser, or prepaid by TableX.

Freight Claims

Legal title to merchandise passes to the buyer upon acceptance by the carrier. All cartons must be carefully inspected upon delivery for visible and concealed damage. If concealed damage has occurred, the carrier must be notified within (5) days. All of our product is thoroughly inspected before it leaves the factory, therefore it is the buyer's responsibility to seek recourse against the carrier.

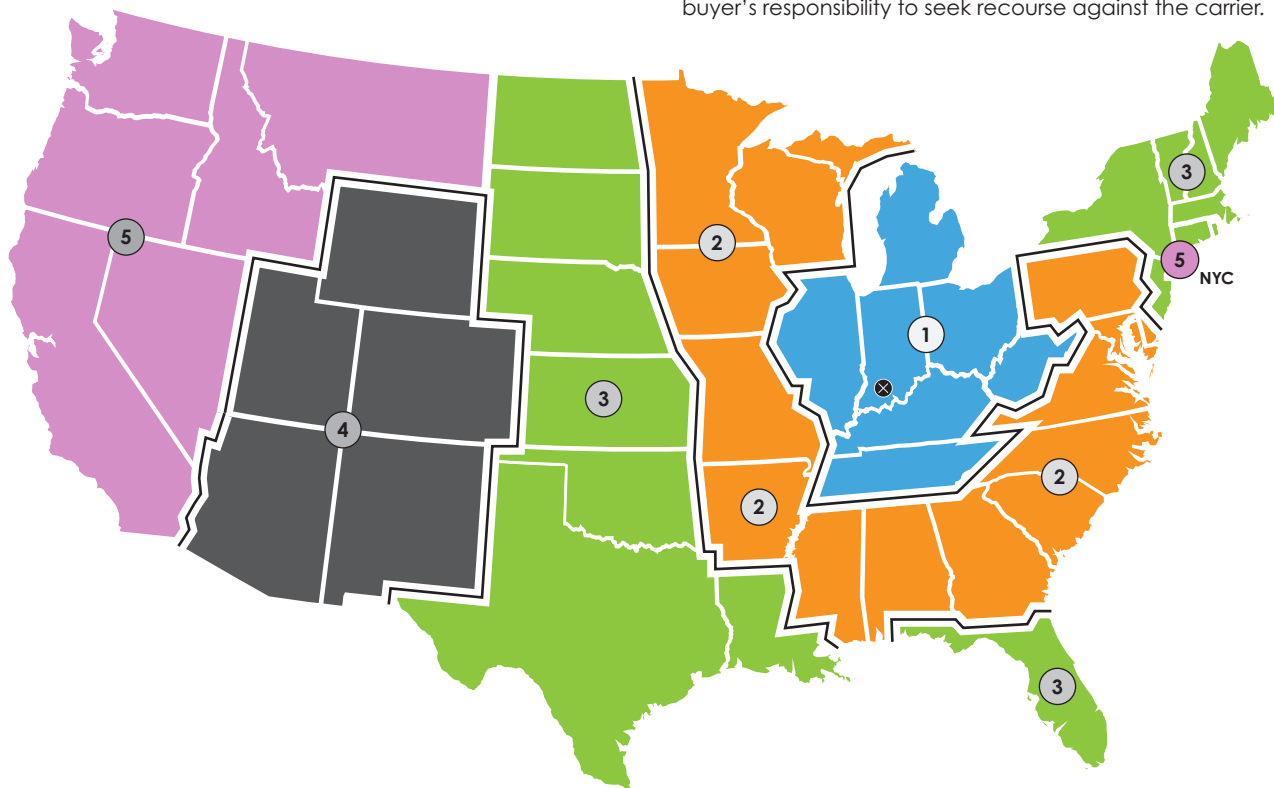

Zone	Destination State	Total List Price / Freight Charge				
		< \$3K	> \$3K	> \$5K	> \$7.5K	> \$10K
1	IL, IN, KY, MI, OH, TN, WV	\$200	free freight			
2	AL, AR, DE, GA, IA, MD, MI-UP, MN, MO, MS, NC, PA, SC, VA, WI	\$300	\$200	free freight		
3	CT, FL, KS, LA, MA, ME, ND, NE, NH, NJ, NY, OK, RI, SD, TX, VT	\$350	\$300	\$200	free freight	
4	AZ, CO, NM, UT, WY	\$400	\$350	\$300	\$200	free
5	CA, ID, MT, NV, NYC, OR, WA	freight charge must be quoted				

Email orders to:
sales@tablex.com

Fax orders to:
812.481.1178

When sending in a purchase order, please be sure to include the following items. Each of these is important to ensure that your order is processed accurately and in a timely manner.



Furniture Dealer
123 Main St.
Middletown, US 12345

ph. 123.456.7890
fax 123.456.7890

PURCHASE ORDER

page 1 of 1

PO #	Date
12-34567-89	10 / 03 / 2023

Your PO #
We will include this on your order acknowledgement for easy tracking.

TO: TableX
555 Cathy Lane
Jasper, IN 47546

SHIP TO: Furniture Dealer
123 Main St.
Middletown, US 12345

'Ship To' Address
Check page 5 to see how location will affect freight charges.

Line	Quantity	Model # / Description	Unit Price	Ext. Price
		Special Instructions: Call 24 hours before delivery: James Abbott, 123.456.7890 Dealer contact: Peter Gray, 123.456.7890		
1	12	01TC2460T22NE-3P-GR.A - 7960K-18/3021/37 Foundation 24x60" rectangular table with 22" wide T-bases. NE: nesting with locking casters GR.A: 1 grommet in location A List Price: \$1,487 Discount: 50/10 Laminate: Wilsonart 7960K-18 Studio Teak 3P: 3MM EDGE: 3021 Espresso BASE: 37 Satin Silver TAG: training room	669.15	8,029.80
2	5	08RD48X36-3W - 7054-60/NG/21 Elite 48" round table with 36" wide X-base. List Price: \$1,377 Discount: 50/10 Laminate: Wilsonart 7054-60 Wild Cherry 3mm Wood - NG-Nutmeg BASE: 21 Silver Frost TAG: break room	619.65	3,098.25
Freight			0.00	0.00
Total order amount				11,128.05

Special Instructions
This includes but is not limited to a requested delivery date, call before delivery, dealer contact, and tagging instructions.

Complete Model #
include any options and your surface materials.

List Price & Discount
This is important so that we can double check any options and upcharges.

Surface Materials
Double check to make sure these are included. this is the piece most often left off of a PO.

Freight Charges
Many larger orders qualify for free freight. reference the chart on page 5 to verify your costs.

Line Item #
Makes cross referencing much easier if we have any questions.

Quantity
Exactly how many of these do you need?

Product Tagging
We will include this on the label underneath each table.



Warranty

Effective April 15, 2020

TableX merchandise limited warranty on the original purchase covers normal use for 50 years from date of shipment against defect regarding workmanship and materials.

Electrical components are covered for 1 year. Moving components; such as, but not exclusive to; casters, flip top mechanisms and height adjustment mechanisms are covered for 5 years. Note of exception on Nesting Extrusions, warranty is 10 years.

Formica, Wilsonart, Pionite, and Nevamar laminates are covered by the specified surface manufacturer under their particular warranty only. TableX does not promote laminate "self edge" tops due to their tendency to be damaged during everyday use. Self edge and butcher block tops are done by special request only and are covered for 1 year.

Finishes, when exposed to ultraviolet rays, may change color. Desktop accessories with rubber or plastic feet can penetrate or burn a finish. These issues are not warranted and will not be the responsibility of TableX.

Exclusions include:

- Normal wear and tear over course of ownership or abuse beyond originally intended use of product.
- Modifications or additions to the product, or final product assembly that is not TableX approved.
- Product used for rental purposes
- Damage caused by misapplication of cleaning chemicals or improper use of core and cleaning procedures.
- Surface materials damaged by excessive humidity or dryness in an uncontrolled environment.

When ordering tops or bases ONLY; TableX will not be held liable for any tops or bases used in conjunction with any other manufacturer's products.

Any repairs or modifications by the customer must receive specific written authorization from TableX prior to being executed, or warranty may be voided.

In no event shall liability under this warranty exceed the original purchase price of the product.

All TableX products are tested to meet or exceed BIFMA standards.

High Pressure Laminates

Standard Laminates

TableX stocks over 40 laminates. With a large selection of patterns, solids, and woodgrains, these laminates are all available at standard pricing.

Special Laminates

TableX also offers additional Wilsonart, Nevamar, Pionite, and Formica laminates. Please contact customer service to confirm pricing and availability of any non-standard laminates.

TableXpress Quickship Program

When ordering TableXpress quickship products, you must select from our standard list of stocked laminates.

Samples

Laminate samples are available by request. Scans of these laminates are also available on tablex.com for reference, but because of variations in monitor and printer calibration we do not suggest specifying without seeing a physical sample.

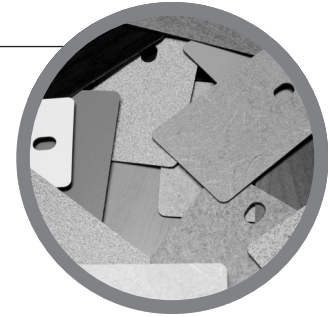

Pattern Laminates

299-58	Ebony Oxide
4621-60	White Nebula
4622-60	Grey Nebula
4623-60	Graphite Nebula
4656-60	Bronze Legacy
4668-60	Mushroom Tigris
4779-60	Pewter Brush
4783-60	White Tigris
4810-60	Titanium EV
4811-60	Silicon EV
4813-60	Nickel EV
4814-60	Tungsten EV
4820-60	Carbon EV
4841-60	Desert Zephyr
4842-60	Canyon Zephyr
4843-60	Misted Zephyr
4844-60	Loden Zephyr
4846-60	Morro Zephyr
4876-38	Sheer Mesh
4879-38	Steel Mesh
4942-38	Crisp Linen
6220-58	Smoke Quarstone
6729-58	Paloma Bisque
7708-58	Flax Gauze
8830-58	Elemental Concrete

Solid Laminates

D96-60	Shadow *
D315-60	Platinum *
D354-60	Designer White *
D355-60	Gunmetal*
D439-60	Wallaby *
1500-60	Grey *
1573-60	Frosty White *
1595-60	Black *
D91-60	Slate Gray *
D381-60	Fashion Grey *
D431-60	Alabaster
899-58	Desert Beige
928-58	Mouse
7197-58	Dover White
8751-58	Mojave

Woodgrain Laminates

7054-60	Wild Cherry *
7122K-07	Empire Mahogany *
7933K-07	Cafelle *
7943K-07	Colombian Walnut *
7946-38	Brazilwood *
7960K-18	Studio Teak *
7964K-12	Skyline Walnut *
7965K-12	Walnut Heights *
10776-60	Kensington Maple *

Woodgrain Laminates (add 5% to list price)

5785-NG	Ashwood Beige *
5786-NG	Ashwood Oak *
5788-NG	Hazel Walnut *
5796-NG	Buff Elm *

* Matching standard 3mm edge available.

Powdercoat Base Colors

Standard Powdercoat Finishes

TableX offers over 30 different powdercoat finishes. Most product lines are available in the full offering of powdercoat colors. Check the series intro for any product specific limitations.

Chrome

Chrome is available on several of our table lines for a standard upcharge per table. Please check the series intro for availability. Also note that chrome bases add 6 weeks to the standard leadtime.

Samples

Paint samples are available by request. Scans of these paint colors are also available on tablex.com for reference, but because of variations in monitor and printer calibration we do not suggest specifying without seeing a physical sample.

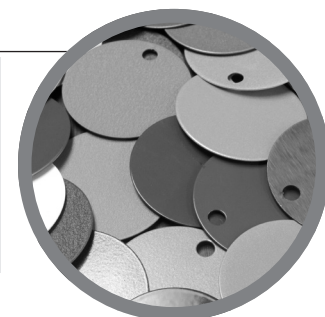

Standard Powdercoat Finishes					
01	Structured Black	37	Satin Silver	49	Dolphin
02	Black	39	Poppy	50	Cannon
05	Structured Slate	40	Rosey	51	Glitz
17	Creame	41	Scarlet	53	Fawn
21	Silver Frost	42	Kiwi	54	Nickel
23	Phantom	43	Kale	55	Pewter
24	Linen	44	Evergreen	56	Kona
25	Storm	45	Horizon	57	Jet
29	Flint	46	Lagoon	58	Cinder
30	Pearl	47	Moonlight	59	Bronze
35	Sand	48	Arctic		

Premium Finishes	
CH	Chrome

Height Adjustable Finishes					
21	Silver Frost	40	Rosey	47	Moonlight
25	Storm	41	Scarlet	55	Pewter
29	Flint	42	Kiwi	56	Kona
30	Pearl	43	Kale	57	Jet
35	Sand	44	Evergreen	59	Bronze
37	Satin Silver	45	Horizon		
39	Poppy	46	Lagoon		

Note

Counterbalance height adjustable tables are only available in 30 Pearl, 57 Jet, or 37 Satin Silver. Electric height adjustable tables are only available in 57 Jet or 37 Satin Silver.

3mm (3P) Edges



3P
Flat

Standard Edges

TableX stocks 9 solid edge colors and 18 woodgrain edges. Seven of those woodgrain edges are also available as a reeded edge.



3P
Reed

TableXpress Quickship Program

When ordering TableXpress quickship products, you must select from our standard list of 3mm edges. Knife edge is not available.

Samples

Edge samples are available by request. Scans of these edges are also available on Tablex.com for reference, but because of variations in monitor and printer calibration we do not suggest specifying without seeing a physical sample.

Solid 3mm Edges	
001	Medium Grey
015	Charcoal
016	Haze
D354	Designer White *
1096	Pepperdust
480	Antique White *
2416	Black *
3020	Iron Alloy
7044	Foundry

Woodgrain 3mm Edges			
TX093	Amaretto Maple	FTX087	Coastal Maple
TX095	Bramble Walnut	FTX089	Colombian Walnut *
TX098	Dusk Walnut	F3022	Warm Cherry
TX103	Walnut Heights *	F3023	Empire Mahogany *
TX104	Studio Teak *	F3024	Traditional Cherry
TX108	Cashew Rift	F3025-2	Blonde Maple 2
TX109	Chestnut Rift	F3026	Cafelle *
TX110	Ashen Rift		
7054	Wild Cherry *		
7946	Brazilwood		
10776	Kensington Maple *		

Woodgrain Reed Edges	
RTX087	Coastal Maple
RTX089	Colombian Walnut *
R3022	Warm Cherry
R3023	Empire Mahogany *
R3024	Traditional Cherry
R3025-2	Blonde Maple 2
R3026	Cafelle *

* Matching standard laminate available.

3mm (3K) Knife Edges

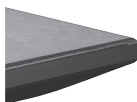

3K
Knife

Knife Edges

Any standard 3mm edge is available as a knife edge. Simply specify the 3mm edge and also specify the paint color for the angled MDF core. There are six colors available. Each is based on a Wilsonart solid laminate color of the same name.

Knife Edges Core Colors	
K91	Slate Grey
K315	Platinum
K354	Designer White
K439	Wallaby
K495	Coffee Bean
K1595	Black

2mm (2P) Acrylic Edges



2P
Acrylic

3D Acrylic Edges

For uses in especially high traffic areas that are prone to impact. 2mm acrylic is designed to be long-lasting and resistant to impact and scratches. Provides a metal edge 'look' without the denting of real metal. **10% upcharge for this edge option.**

Acrylic Edge Options	
3DT	3D Titanium
3DA	3D Aluminum

3mm (3W) Wood Edge Stain

Please check top shape for availability.
Also note that 3mm wood edges add 2-4 weeks to the standard leadtime.

TableXpress

Wood edged tops are not available on our TableXpress Quickship Program.

Care & Maintenance

Clean all surfaces with water-dampened soft cloth in the direction of the grain. Quickly buff dry.

Immediately remove any liquids that come in contact with the wood surfaces using a blotting action to absorb the liquid. Lift objects to move them. Never pull them across the finished surface.

Avoid exposing furniture to extreme heat and cold or to wide humidity variances. Avoid exposing furniture to strong sunlight. Exposure to sunlight over time will cause finish variation. Do not use soaps, commercial cleaners or harsh solvents as they will cause finish deterioration. If using a protective glass top, place spacer pads under the glass top to allow the wood to breathe.

3W
Flat



Samples

Wood finish samples are available by request. Scans of these finishes are also available on tablex.com for reference, but because of variations in monitor and printer calibration we do not suggest specifying without seeing a physical sample.

Wood Edge Stains					
AD	Almond	CI	Cocoa Infusion	NG	Nutmeg
BH	Butterscotch	CT	Chestnut	SE	Spice
BV	Black Velvet				

Coordinating Solid Finishes

Standard Base Colors		Solid Laminates		Solid 3mm Edges		Knife Edge Colors	
02	Black	1595-60	Black	2416	Black	K1595	Black
23	Phantom			3018	Shark	K91	Slate Grey
24	Linen			354	Designer White	K354	Designer White
35	Sand			1096	Pepperdust		
		1572-60	Antique White	1572	Antique White		

Coordinating Woodgrain 3mm Finishes

Woodgrain Laminates		Woodgrain 3mm Edges		Woodgrain Reed Edges	
7122K-07	Empire Mahogany	F3023	Empire Mahogany	R3023	Empire Mahogany
10776-60	Kensington Maple	10776	Kensington Maple		
7933K-07	Cafelle	F3026	Cafelle	R3026	Cafelle
7943-07	Colombian Walnut	FTX089	Colombian Walnut	RTX089	Colombian Walnut
7054-60	Wild Cherry	7054-60	Wild Cherry		
7946-60	Brazilwood	7946-60	Brazilwood		
7965K-12	Walnut Heights	TX103	Walnut Heights		
7960K-18	Studio Teak	TX104	Studio Teak		

Nesting T-bases

Rectangular and half-round tables nest and stow with ease. These tables are noted in the pricer by an "NE" at the end of the model number.

Top sizes and shapes vary slightly by series. Rectangular nesting tables larger than 30x66" use a two-handed release.

Locking casters

All nesting T-base models are already priced to include 2" locking casters.

Offset bases not available on 18"d nesting tables.

Staggered Nesting Dimensions

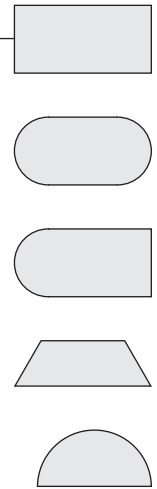
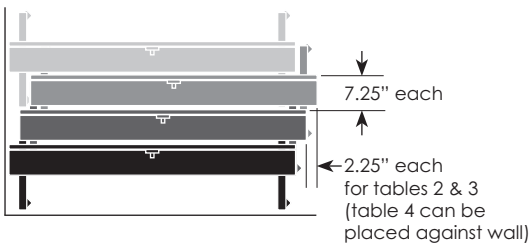

	00 - Ultra	01 - Foundation	02 - Fundamental	06 - Stretch	08 - Elite	09 - Revel	33 - Element	44 - Primary	45 - Puddle	71 - Exclaim	74 - VeriGo	99 - Surge
Nesting Options												
Nesting T	•	•	•	•	•	•	•				•	•



Nesting TT-bases

Large square and round tables don't have to be cumbersome. These tables become easily mobile using our two-handled TT nesting. These tables are noted in the pricer by an "NE" at the end of the model number.

This mechanism is used on 60" & 54" rounds, 48" squares, and 42x60" - 48x72" rectangles. Availability varies slightly by base series.

Locking casters

All nesting TT-base models are already priced to include 3" locking casters.

Staggered Nesting Dimensions

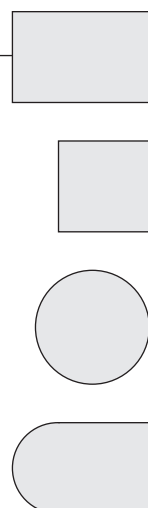
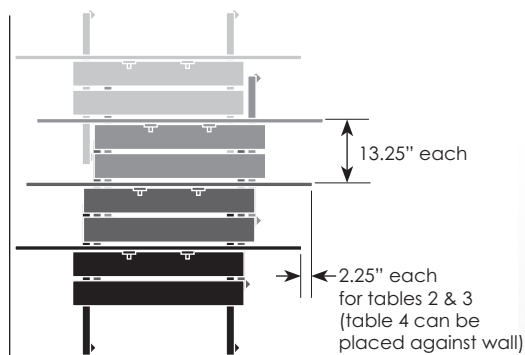

	00 - Ultra	01 - Foundation	02 - Fundamental	06 - Stretch	08 - Elite	33 - Element	44 - Primary	45 - Puddle	71 - Exclaim	74 - VeriGo	99 - Surge
Nesting Options											
Nesting TT	•	•	•	•	•					•	

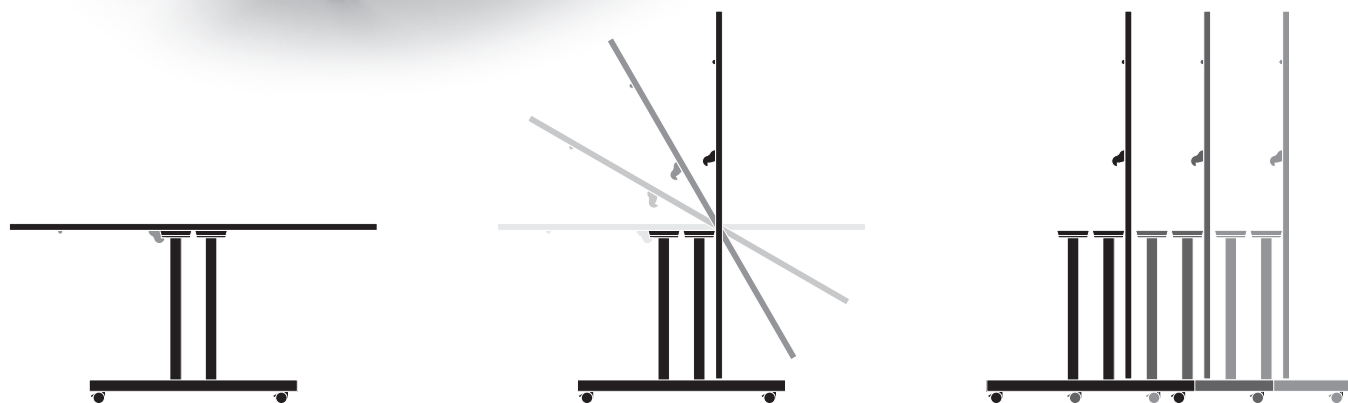

Flip Top X-bases and H-bases

Flip top tables can be a great space saver. These tables are noted in the pricer by an "FT" at the end of the model number.

Round & Square

Availability varies by series. Other options, such as casters, may dictate which sizes are available.

Rectangle & Kidney Bean

Available on VertiGo series H-based tables.



	00 - Ultra	01 - Foundation	02 - Fundamental	06 - Stretch	08 - Elite	33 - Element	44 - Primary	45 - Puddle	71 - Exclaim	74 - VertiGo	99 - Surge
Nesting Options											
Flip Top X		•	•	•	•	•				•	•

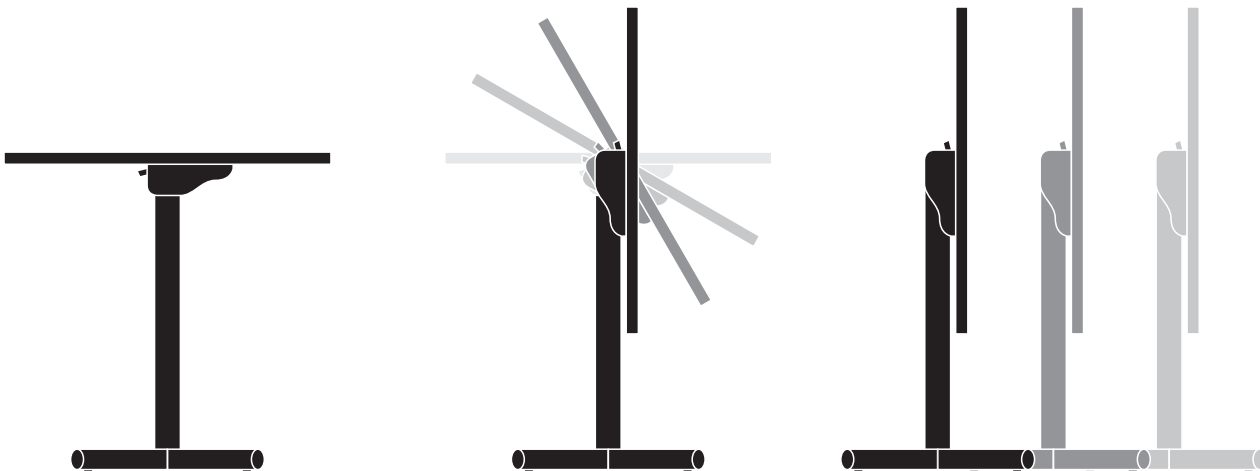

Folding T-bases and TT-bases

Rectangular, racetrack, and some round tables fold for easy storage. These tables are noted in the pricer by an "FD" at the end of the model number.

Standard Folding

Racetrack and rectangular tables 60" and longer use two standard folding mechanisms. Bases fold toward each other and end up toe-to-toe for a total thickness of 4.75" per table.

Short Folding

All round tables and any rectangular tables 48" long or less use a short fold mechanism. Bases fold one over the other for a total thickness of 6.75" per table.

Storage Table Carts

Carts to help store and move tables are available. See pricing below.

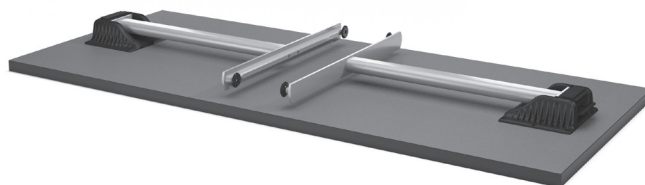
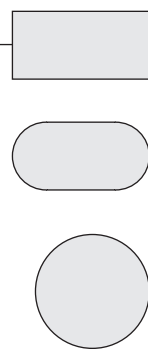

	00 - Ultra	01 - Foundation	02 - Fundamental	06 - Stretch	08 - Elite	33 - Element	44 - Primary	45 - Puddle	71 - Exclaim	74 - VerfiGo	99 - Surge
Folding Options											
Folding T	•	•	•	•	•	•					•
Folding TT	•	•	•	•	•	•					

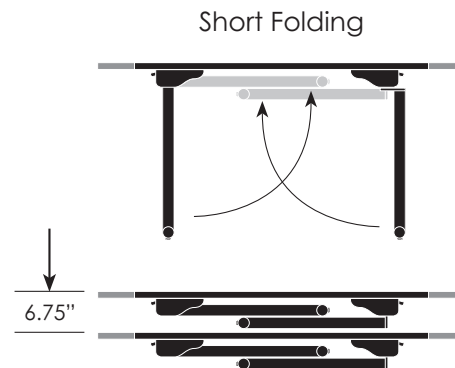
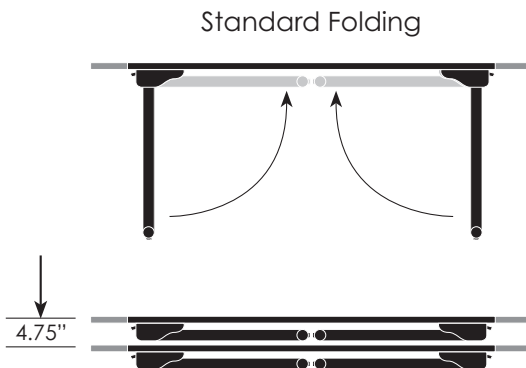

Folding Table Carts

Table Shape	Max Table	Capacity	Model Number	Finish	Price	Mobile Carts
Round	60"	Four short-fold tables	STC-RD60	01 Structured Black	\$ 1,828	
Rectangle	30 x 60"	Six folding tables	STC-TC60	01 Structured Black	1,821	
	30 x 72"	Six folding tables	STC-TC72	01 Structured Black	2,012	
	30 x 84"	Six folding tables	STC-TC84	01 Structured Black	2,042	
	30 x 96 *"	Six folding tables	STC-TC96	01 Structured Black	2,186	

RC 3" Radius Corners

3" radius corners soften the corner of tables to give them a smooth feel. Upcharge is \$61 per table.

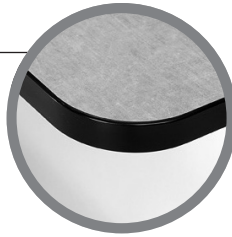

MARKER Markerboard Laminates

White markerboard laminate can be specified on any table for an upcharge of \$111 per table. We suggest pairing this with a dark 3mm edge. Call customer service for custom quotes on other markerboard laminates.



GR Grommets

Grommets can be added to most table shapes for an upcharge of \$45 each. Simply add "-GR" to your model number. 60 mm radius hole. Available in black. See page 227 for location details.

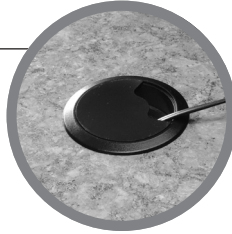

MP Modesty & Privacy Panels

Modesty & privacy panels can be added to many table sizes, and some can also be used on folding and nesting models.

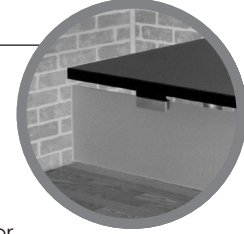

Available in laminate, metal, frosted acrylic, and mesh. See pages 204-207 for complete selection and pricing.

SOLID Solid Surface Tops

Need something a little more substantial? We can offer solid surface tops on many of our tables. These are quite popular on disc and X-based cafe tables. Call customer service for a custom quote. Leadtime on solid surface is usually around 6 weeks.

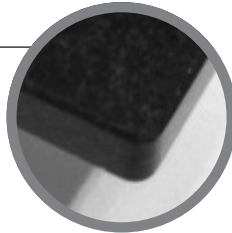

LOGO Custom Logo Tops

Make your laminate table top the focal point of any room by adding your logo in full color. Working with Wilsonart, we can add logos that utilize standard laminates into the background and integrate them into the logos themselves.



This process requires a custom quote, and does require an extended leadtime, but the final results are worth it.

QG Quick-Connect Ganging Brackets

Easily connect and disconnect tables or tables of any shape for simple room configurations. Quick to install and built to last, these table connectors will provide clients with durability and functionality for years to come. These allow for seamless assembly and handling with a low profile design. Upcharge is \$45 (includes 4 connectors per table).



LC Locking Casters

2" locking casters can be added to most tables for an upcharge of \$111 per set of four. Check product details for availability.

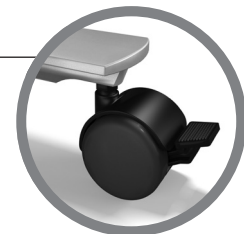

Note: nesting tables are priced with locking casters included.

PHK Bag Hooks

Accessory hooks are great for hanging coats and purses. This is a simple add on item that works on practically any table. \$12 list each.

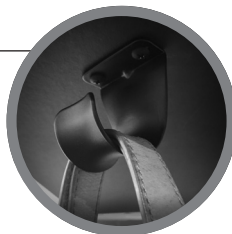

Model #	Description	List Price
#LC	2" locking caster – standard (black)	\$111
#LC-SC	2" locking caster (silver & black)	\$111
#LC1.5	1.5" low-profile locking caster	\$111
#SLC.3	3" locking 'soft' caster for hard floors	\$147

CCG Concealed Casters

Concealed casters can be specified on one side of a T-based table. Other side will have standard glides. Overall height remains at 29". Upcharge is \$137 per table.

Only available on Foundation, Fundamental, & Element series. (Foundation uses black end cap as pictured.)

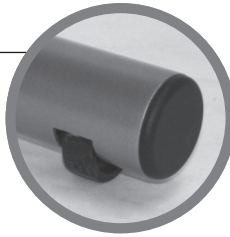

WM Built-in Wire Management

One of two T-bases will have a 1x19" steel access door with self closing hinges. Door height can vary depending on other specified options. Check series details for availability. Upcharge is \$139 per column. See page 226 for details. Not available in chrome.

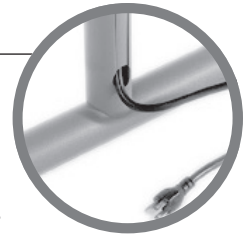

OS Offset T-bases

Most T-bases can be upgraded to offset T-bases. The standard offset is 3". Check product details for availability. Upcharges vary based on series.

Not available on any 18"d tables. Not available on 30"d nesting tables less than 60" wide.

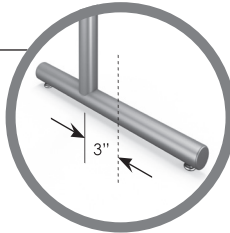

WM LC Snap-on Wire Management Leg Cover

Snaps on to round columns and offers coverage of wires down the leg. Powdercoated steel to match base color. Check series details for compatibility. Upcharge is \$50 for 2" and \$79 for 3" (Surge & Puddle Series). See page 226 for details. Not available in chrome.

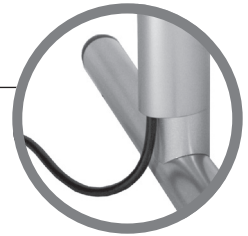

EM Edge Mounted T-bases

T-bases and TT-bases can be specified as edge mounted bases on most static models for \$76. Bases on tables 36-48" in length are already edge mounted.

The position of bases on folding and nesting tables cannot be adjusted.

Table Length	EM
36-48"	standard
60-96"	\$76

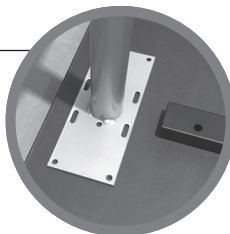

MM LC Magnetic Wire Management Leg Cover

Magnetically attaches to rectangular and square columns and offers coverage of wires down the leg. Powdercoated steel to match base color. Check series details for compatibility. Upcharge is \$71 each. See page 226 for details.

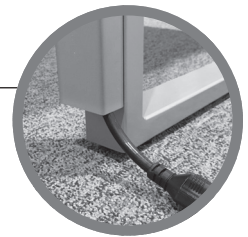

CH Chrome Finish

Chrome finish is a premium finish available on select models. Check product details for availability. Upcharges vary based on series and number of bases.

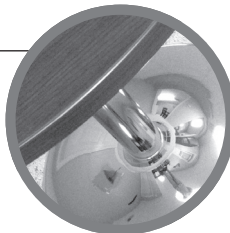

PB Powerbox Mounting Plate

The powerbox is ideal for round and square tables that have a power unit centered in the top. This U-shaped mounting plate allows 2.75x8x12" for the unit itself, wire management through the column, and a hole out the side and bottom of the column. Available on most X-bases and disc bases for \$100 upcharge. \$329 list upcharge on BWE - Bottom Cord Exit on 44 or 99 disc bases.

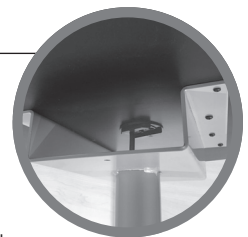

FM LB Floor Mount Leveler Brackets

These brackets are available only as an add-on to our bases and are not for individual sale. Floor mounting hardware not included. Upcharge is \$100 per table.

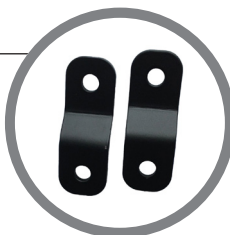

BWE Bottom Cord Exit

Wires are slipped through the column from the mounting plate to the floor. Only available on 44 or 99 disc bases. Upcharge is \$132.

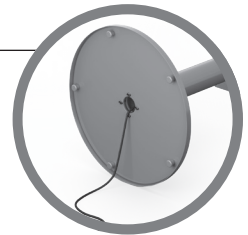

SH Special Height

Special height tables can be specified in most series. Standard height is 29". Upcharges vary based on base and height needed.

Tables larger than 36x72" will need a stretcher bar between the bases. Contact customer service to quote these tables.

When specifying, include your custom height in the model number. For example: (-SH.42) for special height of 42".

Upcharges vary based on base and height needed, see individual series for pricing.

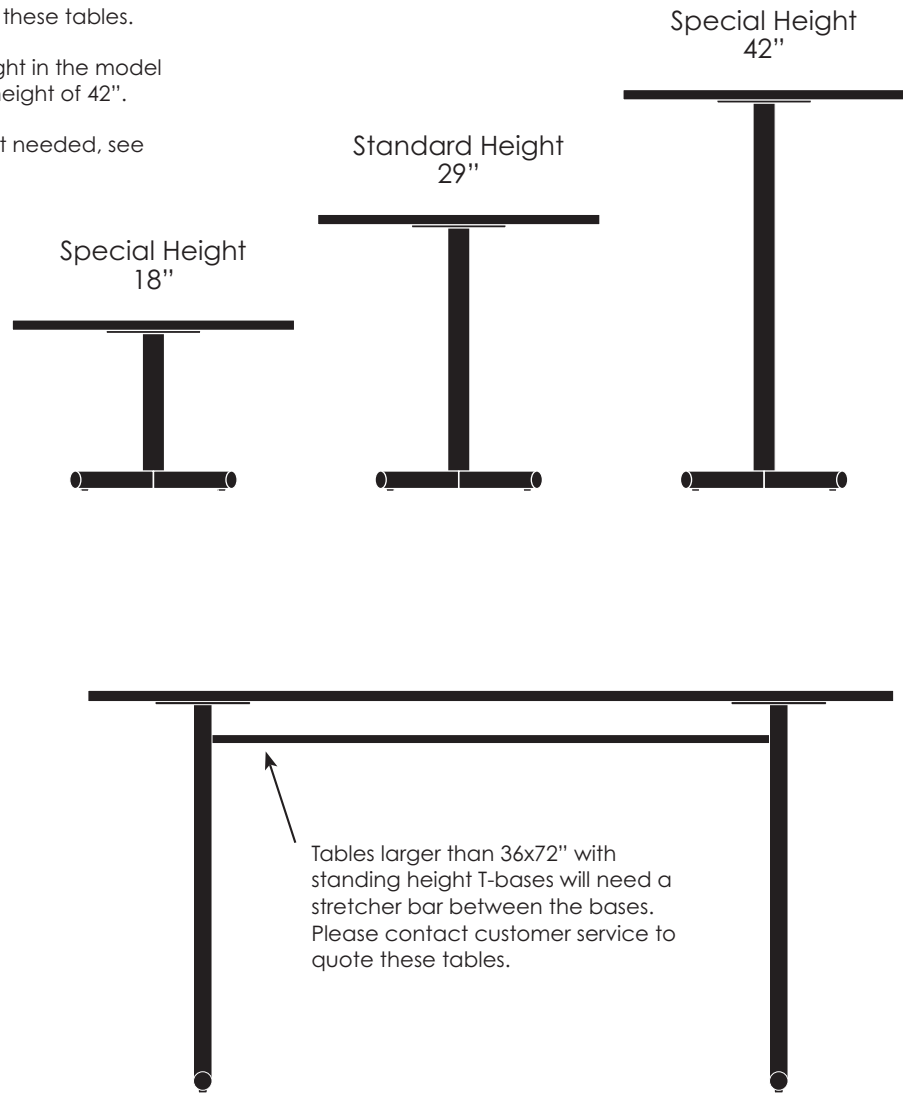

FR Footring

A footring is available on disc bases and select X-bases that are at standing height. Check product details for availability. Upcharge is \$166 per base. Not available in chrome.

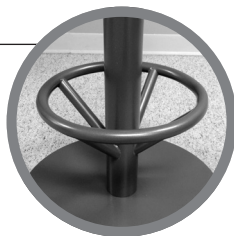



	00 - Ultra	01 - Foundation	02 - Fundamental	06 - Stretch	08 - Elite	33 - Element	44 - Primary	45 - Puddle	71 - Exclaim	74 - VeriGo	99 - Surge
Height Adjustable Options											
Ratchet		•	•							•	
Counterbalance							•	•		•	•
Short Balance							•	•		•	•
Pneumatic		•	•				•	•			
Hand Crank										•	
Electric										•	•
Manual Ext. Height		•	•				•				

EH Electric Height

Electric height adjustability gives you the height range of the counterbalanced option, but is available in a wider variety of top shapes and sizes. The memory keypad remembers your four favorite heights. Available in both VeriGo and Surge.

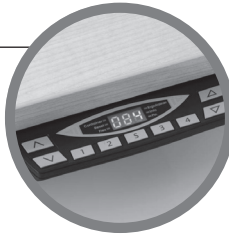

EX Manual Extended Height

This base has the ability to manually change height in 1" increments by removing and re-inserting its bolts. Table height range of 26-42". Available in Foundation (T-bases), Fundamental (T-bases), and Primary series (2" column only).

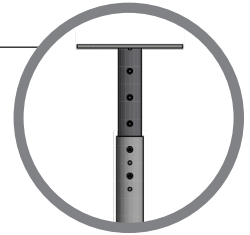

BL Counterbalanced

Need to get the most out of your height adjustable tables? The counterbalanced option is the way to go. Simply squeeze the small handle underneath and gently move the top to your desired height. With a range over 17" and unlimited choices in between, it's just that easy.

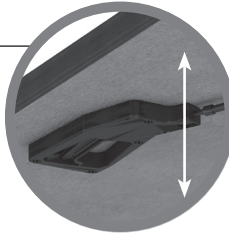

BLS Short Balanced

Go from coffee table height to standard height with the Short Balanced. Simply squeeze the small handle underneath and gently move the top to your desired height. Approximately 18-29".

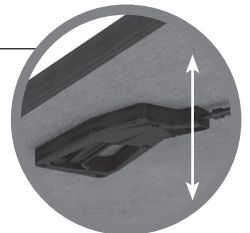

CR Hand Crank

Need the flexibility of infinite adjustability without the budget for counterbalanced bases? Our manual hand crank offers a cost-effective alternative. Only available in the VeriGo series and available on some nesting models.

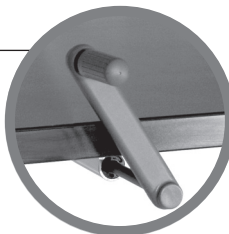

NU Pneumatic

Most square (max 36") and round (max 42") tables are available with pneumatic height adjustability. 12" range in 1" increments. Upcharge is \$387 on X and disc bases.

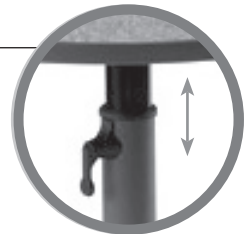

RA Ratchet

Ratchet height adjustability is available on select VeriGo, Foundation, & Fundamental tables. With a range of 9.45," the ratchet works in thirteen increments of .78". To reset to the lowest position, just lift past its highest point. Ratchet height adjustable bases are also available on some nesting tables.

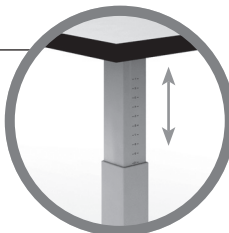

General Guidelines for Seating Capacities

- Allow about 30"/person
- Allow 48" for aisles between tables. ADA has 36" min.
- Allow 96"-120" between presenter and front row.
- Rooms with only one entrance are restricted to accommodate a maximum of 50 people (per fire code).
- Space required for single wheelchair passage is 36" min. and 60" min. for double wheelchair.
- Space required to turn a wheelchair is 60" dia.
- Newer wheelchair arms are designed to fit under standard 29"h tables (older models require an extra 2.5" of clearance)
- ADA Minimum table depth of 24".
- Ganging Wedges are not recommended for seating if top is not supported by a base.
- Capacities are based upon a 30" minimum width per seat. This chart is only a guideline which can vary based upon seating design and table layout.

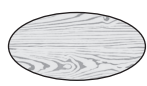

Rectangle						Racetrack				Elliptical			
18 x 30	1												
18 x 36	1	30 x 36	2										
18 x 48	1	30 x 48	2 - 4										
										30 x 54	4		
18 x 60	2	30 x 60	4	48 x 60	6	36 x 60	4			30 x 60	4		
18 x 72	3	30 x 72	6	48 x 72	6 - 8	36 x 72	4					42 x 72	6
18 x 84	4	30 x 84	6	48 x 84	6 - 8	36 x 84	6					42 x 84	6 - 8
18 x 90	4	30 x 90	6	48 x 90	8	36 x 90	8					42 x 90	8
18 x 96	4 - 5	30 x 96	8	48 x 96	8 - 10	36 x 96	6 - 8					42 x 96	8 - 10
				48 x 120	10 - 12			54 x 120	10 - 12			42 x 120	10 - 12
				48 x 144	12			54 x 144	12			42 x 144	12
20 x 36	2												
20 x 48	2	36 x 48	2 - 4										
20 x 60	2 - 3	36 x 60	4 - 6	54 x 60	6					36 x 60	4		
20 x 72	3	36 x 72	6 - 8	54 x 72	8					36 x 72	4	48 x 72	6
20 x 84	4	36 x 84	6 - 8	54 x 84	8	42 x 84	6 - 8			36 x 84	6	48 x 84	6 - 8
20 x 90	4	36 x 90	8	54 x 90	8	42 x 90	8			36 x 90	8	48 x 90	8
20 x 96	4 - 5	36 x 96	8 - 10	54 x 96	8 - 10	42 x 96	8 - 10			36 x 96	6 - 8	48 x 96	8 - 10
				54 x 120	10 - 12	42 x 120	10 - 12	60 x 120	10 - 12			48 x 120	10 - 12
				54 x 144	12	42 x 144	12	60 x 144	12			48 x 144	12
24 x 36	1												
24 x 48	1												
24 x 60	2	42 x 60	6 - 8										
24 x 72	3	42 x 72	6 - 8	60 x 72	8								
24 x 84	4	42 x 84	6 - 8	60 x 84	8	48 x 84	6 - 8						
24 x 90	4	42 x 90	8	60 x 90	8	48 x 90	8						
24 x 96	4 - 5	42 x 96	8 - 10	60 x 96	8 - 10	48 x 96	8 - 10						
				42 x 120	10 - 12	48 x 120	10 - 12						
				42 x 144	12	48 x 144	12						

Square		Round	
24 x 24	2	24 x 24	2
30 x 30	2	30 x 30	2
36 x 36	4	36 x 36	3
42 x 42	4	42 x 42	4
48 x 48	4	48 x 48	4 - 5
54 x 54	4 - 8	54 x 54	5
60 x 60	4 - 8	60 x 60	6 - 7



D-shaped

24 x 36	1	42 x 60	5 - 7
24 x 48	1	42 x 72	5 - 7
24 x 60	2	42 x 84	5 - 7
24 x 72	3	42 x 90	7
24 x 84	3	42 x 96	7 - 9
24 x 90	3	48 x 60	5 - 7
24 x 96	2 - 3	48 x 72	5 - 7
30 x 48	2 - 3	48 x 84	5 - 7
30 x 60	3	48 x 90	7
30 x 72	5	48 x 96	7 - 9
30 x 84	5	54 x 54	4
30 x 90	5	54 x 60	6
30 x 96	7	54 x 72	8
36 x 48	2 - 3	54 x 84	8
36 x 60	3 - 5	54 x 90	8
36 x 72	5 - 7	54 x 96	8 - 10
36 x 84	5 - 7	54 x 120	10 - 12
36 x 90	7	54 x 144	12
36 x 96	7 - 9	60 x 60	6
		60 x 72	8
		60 x 84	8
		60 x 90	8
		60 x 96	8 - 10
		60 x 120	10 - 12
		60 x 144	12



Boat-shaped

30 x 42 x 84	6 - 8
30 x 42 x 90	8
30 x 42 x 96	8 - 10
36 x 48 x 84	6 - 8
36 x 48 x 90	8
36 x 48 x 96	8 - 10
36 x 48 x 120	10 - 12
36 x 48 x 144	12
48 x 54 x 120	10 - 12
48 x 54 x 144	12
54 x 60 x 120	10 - 12
54 x 60 x 144	12



Squirle

24 x 24	2
30 x 30	2
36 x 36	4
42 x 42	4
48 x 48	4



Half Round

18 x 36	1 - 2
24 x 48	2
30 x 60	3
36 x 72	4



Trapezoid

24 x 48	4 - 5
24 x 72	4 - 5
30 x 60	4 - 5
36 x 72	4 - 5