



tablex



price list

Effective October 1, 2023





TableX Customer Service:
877.481.1177
sales@tablex.com

Welcome to our October 2023 TableX price list. We have made a number of important product additions and several deletions to this most recent price book update. Please confirm you have the most current TableX product details and list prices by visiting: www.tablex.com/pricing.

If you have any questions, or need something above and beyond the standard solutions shown in this book, please don't hesitate to contact us. We welcome custom requests and are here to help you.

Introduction	Page
Pricing Comparison	p. 2
Terms & Conditions	p. 4
<ul style="list-style-type: none"> • Pricing • Orders • Order Acknowledgements • Terms • Lead Times • Modified Product • Cancellations & Returns 	
Freight	p. 5
<ul style="list-style-type: none"> • Freight Charges • Shipping 	
Sample Purchase Order	p. 6
Warranty	p. 7
Surface Materials	p. 8
<ul style="list-style-type: none"> • High Pressure Laminates • Powdercoat Base Colors • 3mm PVC Edges • 3mm PVC Knife Edges • Wood Edges (3mm only) • Coordinating Finishes 	
Table Options	p. 12
<ul style="list-style-type: none"> • Nesting Tables • Folding Tables • Flip Top Tables • Folding Tables • Top Options • Base Options • Custom Height Options • Height Adjustable Options 	
Seating Capacities	p. 20

Product Pricing	Page
TableXpress Quickship Program	p. 22
00 - Ultra Series	p. 28
01 - Foundation Series	p. 36
02 - Fundamental Series	p. 52
06 - Stretch Series	p. 68
08 - Elite Series	p. 85
09 - Revel Series	p. 102
17 - App Series	p. 106
33 - Element Series	p. 110
40 - Justice Series	p. 124
43 - Artisan Series	p. 132
44 - Primary Series	p. 138
45 - Puddle Series	p. 144
71 - Exclaim Series	p. 164
74 - VertiGo Series	p. 174
99 - Surge Series	p. 194
Table Accessories	p. 212
<ul style="list-style-type: none"> • Modesty Panels • Privacy Panels 	
Power / Data	p. 218
<ul style="list-style-type: none"> • Metal Pop-up Units • Budget Units • Daisylink Systems • Corded Systems 	
Wire Management	p. 226

24x60" Rectangles

Something as simple as a 24x60" rectangular table can be specified many different ways. With 12 different standard series of bases, TableX has you covered. Use the matrix below to compare list pricing of each series, using a static, 24x60" rectangular table with a 3P (3mm PVC) edge.



Ultra
p.32

\$1,107 List

Foundation
p.40

\$793

Fundamental
p.56

\$784

Stretch
p.72

\$839

Elite
p.88

\$985

Revel
p.105

\$929

Element
p.114

\$839

Justice
p.128

\$1,342

Artisan
p.136

\$1,680

Primary
p.142

four columns
\$900

Primary
p.143

two 44 discs
\$1,799

Puddle
p.158

two 45 discs
\$1,562

Exclaim
p.164

\$1,102

VertiGo
p.181

\$876

Surge
p.200

\$929













Surge
p.202

two 99 discs
\$1,491

36" Rounds

Cafe and lounge tables are being utilized everywhere. TableX offers a wide variety of bases that give you plenty of choices. Use the matrix below to compare list pricing of each series, using a static, 36" round table with a 3P (3mm PVC) edge.



<p>Foundation p.47</p>  <p>\$828 List</p>	<p>Fundamental p.63</p>  <p>\$791</p>	<p>Stretch p.79</p>  <p>\$1,037</p>	<p>Elite p.97</p>  <p>\$996</p>
<p>Element p.119</p>  <p>\$1,003</p>	<p>Primary p.149</p>  <p>four columns \$895</p>	<p>Primary p.149</p>  <p>44 disc \$1,172</p>	<p>Puddle p.159</p>  <p>45 disc \$1,053</p>
<p>VertiGo p.189</p>  <p>\$1,044</p>	<p>VertiGo p.189</p>  <p>74 disc \$1,057</p>	<p>Surge p.207</p>  <p>\$1,005</p>	<p>Surge p.207</p>  <p>99 disc \$1,018</p>

Pricing

All prices quoted are list prices, FOB our warehouse. All documentation and literature is based on the most recent information available at the time of this publication. We reserve the right to make product improvements and design enhancements at any time, without notice. Prices are subject to change without notification.

Orders

All orders must be received in writing with complete information. See page 6 for a sample purchase order and a checklist of information that is required to place an order.

E-mail orders to:
sales@tablex.com

Fax orders to:
812.481.1178

Duplicate orders that are not marked as such are the responsibility of the customer.

Order Acknowledgements

Orders are acknowledged upon receipt at TableX. No order shall be binding upon TableX until we confirm it with an acknowledgement. The customer bears sole responsibility for order correctness. All orders will be manufactured and invoiced in accordance with the acknowledgement. Customers must notify TableX in writing of any discrepancy **within 5 days**. Any subsequent change order is dependent upon our ability to accommodate the specification, terms and status of the order in production, and may be subject to additional charges for labor, material and other costs involved.

Terms

Terms are Net 30 days from the date of invoice. Payment is due when invoice is issued and is considered delinquent if not paid within 30 days. Interest will be charged at the rate of 1.5% per month on delinquent accounts. TableX does not create or provide statements.

Lead Times

Lead times can vary based on product availability, fluctuations in busy season, and national holidays. Please contact customer service at 877.481.1177 for current lead times.

Note: Selecting certain options (3mm wood edges, chrome bases, or solid surface tops) can impact lead time. Below are estimated lead times based on normal business conditions.

Laminate	Edge	Base	Standard Lead Time
TableXpress Program			7-10 day quickship
standard	3mm PVC	standard	4-5 weeks
solid surface tops			4-6 weeks
	3mm wood		6-8 weeks
		chrome	10 weeks

Modified Product

TableX prides itself on providing you with product that exceeds your expectations. Sometimes your needs are outside the standard product offering. Our flexibility as a smaller company allows us to accommodate requests for non-cataloged product. Contact Customer Service at 877.481.1177 to discuss your unique product requirements and we'll help you meet your needs.

Cancellations & Returns

Our acceptance of an order is final and binding and not subject to cancellation by the customer. No merchandise may be returned without the written consent of TableX. When ordering electrical components on pages 218-227, it is the responsibility of the customer to ensure the components selected meet local electrical codes. Electrical components are made-to-order and cannot be returned.

Freight Charges

TableX is located in Jasper, Indiana. All shipping zones are based on proximity to our facility.

Minimum Orders

Standard freight charges apply to any order under \$3,000 total list price shipping within the continental United States. The standard charge for each zone is shown below, based on the total list price of the order.

Tiered Freight Program

These freight charges are reduced or waived on orders based on their total list price. The qualifying list prices for each zone are shown below.

Shipping

All shipments are F.O.B., dock-to-dock from our warehouse. Charges for additional services such as lift gates, non-commercial deliveries, inside deliveries, oversized pallets (pallets used for single table tops 90" or longer), and call before delivery are the responsibility of the buyer and may be charged to the buyer after the date of delivery.

Legal responsibility for the product transfers to the buyer upon acceptance by the carrier. Damaged, lost or shorted shipments are the responsibility of the carrier. Inspect all shipments promptly upon arrival and note any damage or loss on the delivery receipt. If damage is concealed, keep the packing and notify the carrier immediately for an inspection. Carriers require such reports within 5 days of delivery. Failure to report damage or loss is the consignee's responsibility. The freight charges may be collect to the receiver, billed to the purchaser, or prepaid by TableX.

Freight Claims

Legal title to merchandise passes to the buyer upon acceptance by the carrier. All cartons must be carefully inspected upon delivery for visible and concealed damage. If concealed damage has occurred, the carrier must be notified within (5) days. All of our product is thoroughly inspected before it leaves the factory, therefore it is the buyer's responsibility to seek recourse against the carrier.

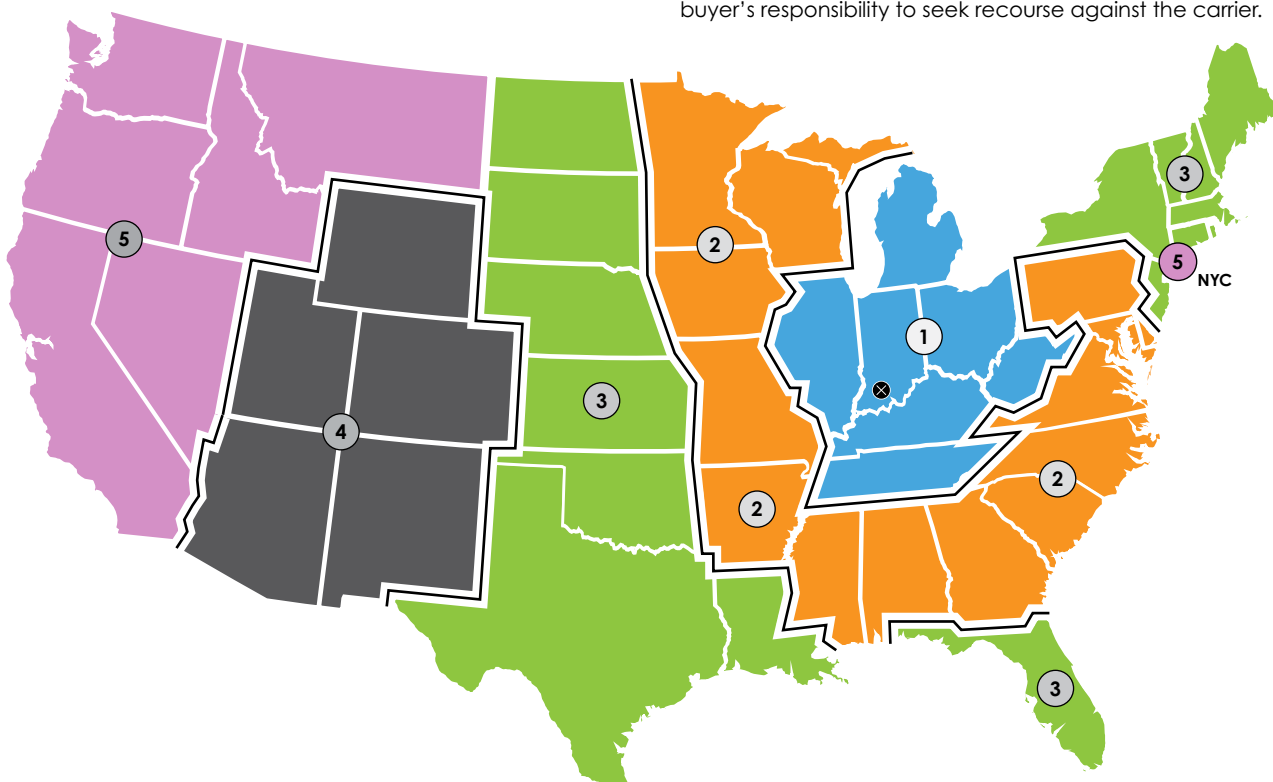

Zone	Destination State	Total List Price / Freight Charge				
		< \$3K	> \$3K	> \$5K	> \$7.5K	> \$10K
1	IL, IN, KY, MI, OH, TN, WV	\$200	free freight			
2	AL, AR, DE, GA, IA, MD, MI-UP, MN, MO, MS, NC, PA, SC, VA, WI	\$300	\$200	free freight		
3	CT, FL, KS, LA, MA, ME, ND, NE, NH, NJ, NY, OK, RI, SD, TX, VT	\$350	\$300	\$200	free freight	
4	AZ, CO, NM, UT, WY	\$400	\$350	\$300	\$200	free
5	CA, ID, MT, NV, NYC, OR, WA	freight charge must be quoted				

Email orders to:
sales@tablex.com

Fax orders to:
812.481.1178

When sending in a purchase order, please be sure to include the following items. Each of these is important to ensure that your order is processed accurately and in a timely manner.



Furniture Dealer
123 Main St.
Middletown, US 12345

ph. 123.456.7890
fax 123.456.7890

PURCHASE ORDER

page 1 of 1

PO #	Date
12-34567-89	10 / 03 / 2023

Your PO #

We will include this on your order acknowledgement for easy tracking.

TO: TableX
555 Cathy Lane
Jasper, IN 47546

SHIP TO: Furniture Dealer
123 Main St.
Middletown, US 12345

'Ship To' Address

Check page 5 to see how location will affect freight charges.

Line	Quantity	Model # / Description	Unit Price	Ext. Price
		Special Instructions: Call 24 hours before delivery: James Abbott, 123.456.7890 Dealer contact: Peter Gray, 123.456.7890		
1	12	01TC2460T22NE-3P-GR.A - 7960K-18/3021/37 Foundation 24x60" rectangular table with 22" wide T-bases. NE: nesting with locking casters GR.A: 1 grommet in location A List Price: \$1,487 Discount: 50/10 Laminate: Wilsonart 7960K-18 Studio Teak 3P: 3MM EDGE: 3021 Espresso BASE: 37 Satin Silver TAG: training room	669.15	8,029.80
2	5	08RD48X36-3W - 7054-60/NG/21 Elite 48" round table with 36" wide X-base. List Price: \$1,377 Discount: 50/10 Laminate: Wilsonart 7054-60 Wild Cherry 3mm Wood - NG-Nutmeg BASE: 21 Silver Frost TAG: break room	619.65	3,098.25
Freight			0.00	0.00
Total order amount				11,128.05

Special Instructions

This includes but is not limited to a requested delivery date, call before delivery, dealer contact, and tagging instructions.

Complete Model #

include any options and your surface materials.

List Price & Discount

This is important so that we can double check any options and upcharges.

Surface Materials

Double check to make sure these are included. this is the piece most often left off of a PO.

Freight Charges

Many larger orders qualify for free freight. reference the chart on page 5 to verify your costs.

Line Item #
Makes cross referencing much easier if we have any questions.

Quantity
Exactly how many of these do you need?

Product Tagging
We will include this on the label underneath each table.



Warranty

Effective April 15, 2020

TableX merchandise limited warranty on the original purchase covers normal use for 50 years from date of shipment against defect regarding workmanship and materials.

Electrical components are covered for 1 year. Moving components; such as, but not exclusive to; casters, flip top mechanisms and height adjustment mechanisms are covered for 5 years. Note of exception on Nesting Extrusions, warranty is 10 years.

Formica, Wilsonart, Pionite, and Nevamar laminates are covered by the specified surface manufacturer under their particular warranty only. TableX does not promote laminate "self edge" tops due to their tendency to be damaged during everyday use. Self edge and butcher block tops are done by special request only and are covered for 1 year.

Finishes, when exposed to ultraviolet rays, may change color. Desktop accessories with rubber or plastic feet can penetrate or burn a finish. These issues are not warranted and will not be the responsibility of TableX.

- Exclusions include:**
- Normal wear and tear over course of ownership or abuse beyond originally intended use of product.
 - Modifications or additions to the product, or final product assembly that is not TableX approved.
 - Product used for rental purposes
 - Damage caused by misapplication of cleaning chemicals or improper use of core and cleaning procedures.
 - Surface materials damaged by excessive humidity or dryness in an uncontrolled environment.

When ordering tops or bases ONLY; TableX will not be held liable for any tops or bases used in conjunction with any other manufacturer's products.

Any repairs or modifications by the customer must receive specific written authorization from TableX prior to being executed, or warranty may be voided.

In no event shall liability under this warranty exceed the original purchase price of the product.

All TableX products are tested to meet or exceed BIFMA standards.

High Pressure Laminates

Standard Laminates

TableX stocks over 40 laminates. With a large selection of patterns, solids, and woodgrains, these laminates are all available at standard pricing.

Special Laminates

TableX also offers additional Wilsonart, Nevamar, Pionite, and Formica laminates. Please contact customer service to confirm pricing and availability of any non-standard laminates.

TableXpress Quickship Program

When ordering TableXpress quickship products, you must select from our standard list of stocked laminates.

Samples

Laminate samples are available by request. Scans of these laminates are also available on tablex.com for reference, but because of variations in monitor and printer calibration we do not suggest specifying without seeing a physical sample.

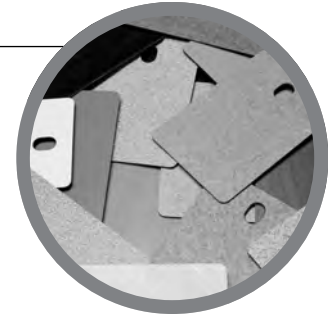

Pattern Laminates

299-58	Ebony Oxide
4621-60	White Nebula
4622-60	Grey Nebula
4623-60	Graphite Nebula
4656-60	Bronze Legacy
4668-60	Mushroom Tigris
4779-60	Pewter Brush
4783-60	White Tigris
4810-60	Titanium EV
4811-60	Silicon EV
4813-60	Nickel EV
4814-60	Tungsten EV
4820-60	Carbon EV
4841-60	Desert Zephyr
4842-60	Canyon Zephyr
4843-60	Misted Zephyr
4844-60	Loden Zephyr
4846-60	Morro Zephyr
4876-38	Sheer Mesh
4879-38	Steel Mesh
4942-38	Crisp Linen
6220-58	Smoke Quarstone
6729-58	Paloma Bisque
7708-58	Flax Gauze
8830-58	Elemental Concrete

Solid Laminates

D96-60	Shadow *
D315-60	Platinum *
D354-60	Designer White *
D355-60	Gunmetal*
D439-60	Wallaby *
1500-60	Grey *
1573-60	Frosty White *
1595-60	Black *
D91-60	Slate Gray *
D381-60	Fashion Grey *
D431-60	Alabaster
899-58	Desert Beige
928-58	Mouse
7197-58	Dover White
8751-58	Mojave

Woodgrain Laminates

7054-60	Wild Cherry *
7122K-07	Empire Mahogany *
7933K-07	Cafelle *
7943K-07	Colombian Walnut *
7946-38	Brazilwood *
7960K-18	Studio Teak *
7964K-12	Skyline Walnut *
7965K-12	Walnut Heights *
10776-60	Kensington Maple *

Woodgrain Laminates (add 5% to list price)

5785-NG	Ashwood Beige *
5786-NG	Ashwood Oak *
5788-NG	Hazel Walnut *
5796-NG	Buff Elm *

* Matching standard 3mm edge available.

Powdercoat Base Colors

Standard Powdercoat Finishes

TableX offers over 30 different powdercoat finishes. Most product lines are available in the full offering of powdercoat colors. Check the series intro for any product specific limitations.

Chrome

Chrome is available on several of our table lines for a standard upcharge per table. Please check the series intro for availability. Also note that chrome bases add 6 weeks to the standard leadtime.

Samples

Paint samples are available by request. Scans of these paint colors are also available on tablex.com for reference, but because of variations in monitor and printer calibration we do not suggest specifying without seeing a physical sample.

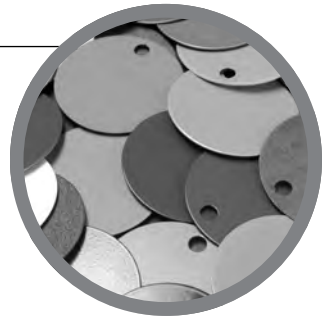

Standard Powdercoat Finishes					
01	Structured Black	37	Satin Silver	49	Dolphin
02	Black	39	Poppy	50	Cannon
05	Structured Slate	40	Rosey	51	Glitz
17	Creame	41	Scarlet	53	Fawn
21	Silver Frost	42	Kiwi	54	Nickel
23	Phantom	43	Kale	55	Pewter
24	Linen	44	Evergreen	57	Jet
25	Storm	45	Horizon	58	Cinder
29	Flint	46	Lagoon	59	Bronze
30	Pearl	47	Moonlight		
35	Sand	48	Arctic		

Premium Finishes	
CH	Chrome

Height Adjustable Finishes					
21	Silver Frost	40	Rosey	47	Moonlight
25	Storm	41	Scarlet	55	Pewter
29	Flint	42	Kiwi	57	Jet
30	Pearl	43	Kale	59	Bronze
35	Sand	44	Evergreen		
37	Satin Silver	45	Horizon		
39	Poppy	46	Lagoon		

Note

Counterbalance height adjustable tables are only available in 30 Pearl, 57 Jet, or 37 Satin Silver. Electric height adjustable tables are only available in 57 Jet or 37 Satin Silver.

3mm (3P) Edges



3P
Flat

Standard Edges

TableX stocks 9 solid edge colors and 18 woodgrain edges. Seven of those woodgrain edges are also available as a reeded edge.



3P
Reed

TableXpress Quickship Program

When ordering TableXpress quickship products, you must select from our standard list of 3mm edges. Knife edge is not available.

Samples

Edge samples are available by request. Scans of these edges are also available on Tablex.com for reference, but because of variations in monitor and printer calibration we do not suggest specifying without seeing a physical sample.

Solid 3mm Edges

001	Medium Grey
015	Charcoal
016	Haze
D354	Designer White *
1096	Pepperdust
480	Antique White *
2416	Black *
3020	Iron Alloy
7044	Foundry

Woodgrain 3mm Edges

TX093	Amaretto Maple	FTX087	Coastal Maple
TX095	Bramble Walnut	FTX089	Colombian Walnut *
TX098	Dusk Walnut	F3022	Warm Cherry
TX103	Walnut Heights *	F3023	Empire Mahogany *
TX104	Studio Teak *	F3024	Traditional Cherry
TX108	Cashew Rift	F3025-2	Blonde Maple 2
TX109	Chestnut Rift	F3026	Cafelle *
TX110	Ashen Rift		
7054	Wild Cherry *		
7946	Brazilwood		
10776	Kensington Maple *		

Woodgrain Reed Edges

RTX087	Coastal Maple
RTX089	Colombian Walnut *
R3022	Warm Cherry
R3023	Empire Mahogany *
R3024	Traditional Cherry
R3025-2	Blonde Maple 2
R3026	Cafelle *

* Matching standard laminate available.

3mm (3K) Knife Edges



3K
Knife

Knife Edges

Any standard 3mm edge is available as a knife edge. Simply specify the 3mm edge and also specify the paint color for the angled MDF core. There are six colors available. Each is based on a Wilsonart solid laminate color of the same name.

Knife Edges Core Colors

K91	Slate Grey
K315	Platinum
K354	Designer White
K439	Wallaby
K495	Coffee Bean
K1595	Black

2mm (2P) Acrylic Edges



2P
Acrylic

3D Acrylic Edges

For uses in especially high traffic areas that are prone to impact. 2mm acrylic is designed to be long-lasting and resistant to impact and scratches. Provides a metal edge 'look' without the denting of real metal. **10% upcharge for this edge option.**

Acrylic Edge Options

3DT	3D Titanium
3DA	3D Aluminum

3mm (3W) Wood Edge Stain

Please check top shape for availability. Also note that 3mm wood edges add 2-4 weeks to the standard leadtime.

TableXpress

Wood edged tops are not available on our TableXpress Quickship Program.

Care & Maintenance

Clean all surfaces with water-dampened soft cloth in the direction of the grain. Quickly buff dry.

Immediately remove any liquids that come in contact with the wood surfaces using a blotting action to absorb the liquid. Lift objects to move them. Never pull them across the finished surface.

Avoid exposing furniture to extreme heat and cold or to wide humidity variances. Avoid exposing furniture to strong sunlight. Exposure to sunlight over time will cause finish variation. Do not use soaps, commercial cleaners or harsh solvents as they will cause finish deterioration. If using a protective glass top, place spacer pads under the glass top to allow the wood to breathe.

3W
Flat



Samples

Wood finish samples are available by request. Scans of these finishes are also available on tablex.com for reference, but because of variations in monitor and printer calibration we do not suggest specifying without seeing a physical sample.

Wood Edge Stains					
AD	Almond	CI	Cocoa Infusion	NG	Nutmeg
BH	Butterscotch	CT	Chestnut	SE	Spice
BV	Black Velvet				

Coordinating Solid Finishes

Standard Base Colors		Solid Laminates		Solid 3mm Edges		Knife Edge Colors	
02	Black	1595-60	Black	2416	Black	K1595	Black
23	Phantom			3018	Shark	K91	Slate Grey
24	Linen			354	Designer White	K354	Designer White
35	Sand			1096	Pepperdust		
		1572-60	Antique White	1572	Antique White		

Coordinating Woodgrain 3mm Finishes

Woodgrain Laminates		Woodgrain 3mm Edges		Woodgrain Reed Edges	
7122K-07	Empire Mahogany	F3023	Empire Mahogany	R3023	Empire Mahogany
10776-60	Kensington Maple	10776	Kensington Maple		
7933K-07	Cafelle	F3026	Cafelle	R3026	Cafelle
7943-07	Colombian Walnut	FTX089	Colombian Walnut	RTX089	Colombian Walnut
7054-60	Wild Cherry	7054-60	Wild Cherry		
7946-60	Brazilwood	7946-60	Brazilwood		
7965K-12	Walnut Heights	TX103	Walnut Heights		
7960K-18	Studio Teak	TX104	Studio Teak		

Nesting T-bases

Rectangular and half-round tables nest and stow with ease. These tables are noted in the pricer by an "NE" at the end of the model number.

Top sizes and shapes vary slightly by series. Rectangular nesting tables larger than 30x66" use a two-handed release.

Locking casters

All nesting T-base models are already priced to include 2" locking casters.

Offset bases not available on 18"d nesting tables.

Staggered Nesting Dimensions

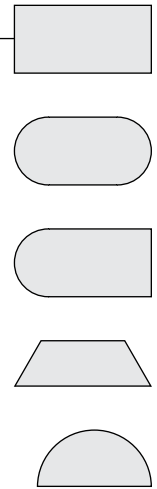
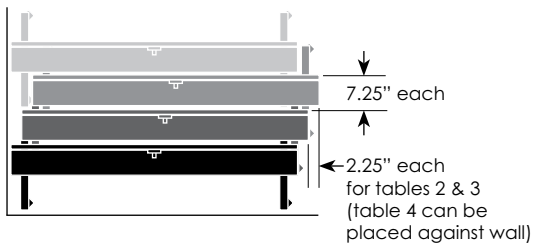

00 - Ultra	01 - Foundation	02 - Fundamental	06 - Stretch	08 - Elite	09 - Revel	33 - Element	44 - Primary	45 - Puddle	71 - Exclaim	74 - VeriGo	99 - Surge
------------	-----------------	------------------	--------------	------------	------------	--------------	--------------	-------------	--------------	-------------	------------

Nesting Options											
Nesting T	•	•	•	•	•	•				•	•

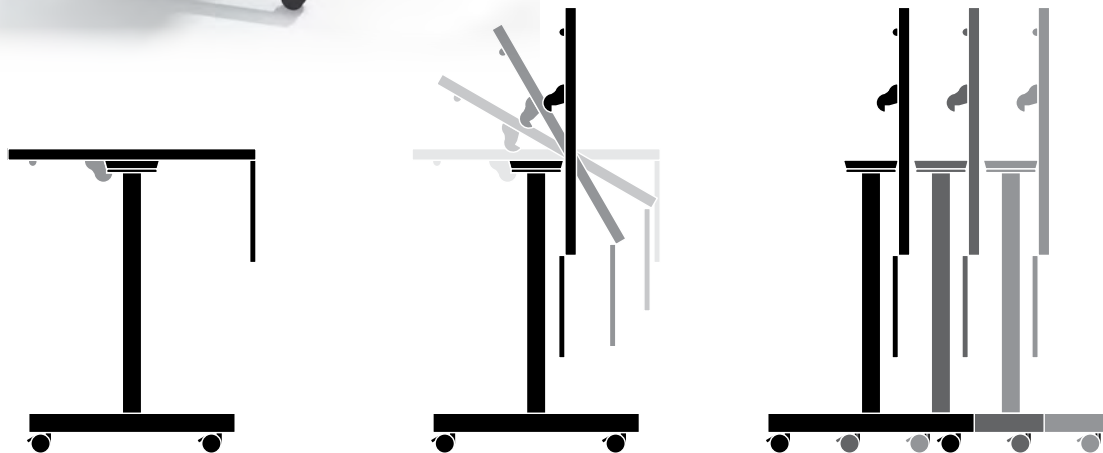

Nesting TT-bases

Large square and round tables don't have to be cumbersome. These tables become easily mobile using our two-handled TT nesting. These tables are noted in the pricer by an "NE" at the end of the model number.

This mechanism is used on 60" & 54" rounds, 48" squares, and 42x60" - 48x72" rectangles. Availability varies slightly by base series.

Locking casters

All nesting TT-base models are already priced to include 3" locking casters.

Staggered Nesting Dimensions

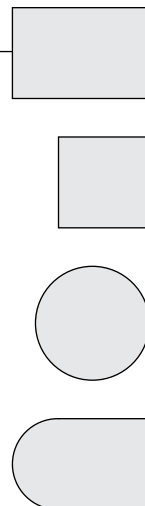
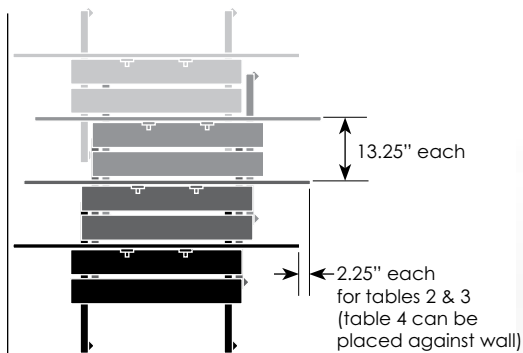

Nesting Options	
00 - Ultra	
01 - Foundation	•
02 - Fundamental	•
06 - Stretch	•
08 - Elite	•
33 - Element	
44 - Primary	
45 - Puddle	
71 - Exclaim	
74 - VeriGo	•
99 - Surge	

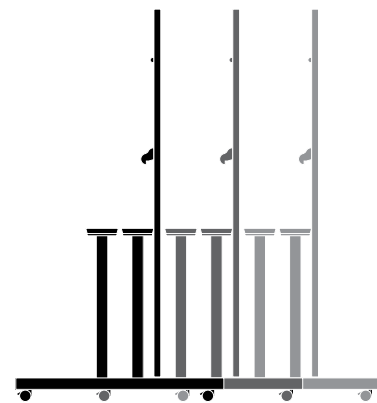
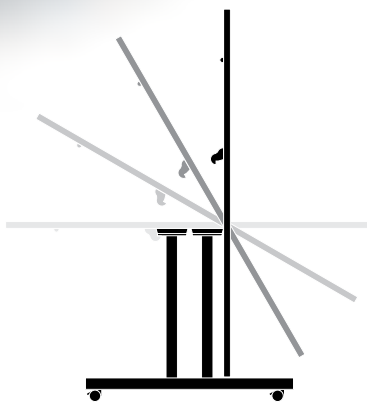

Flip Top X-bases and H-bases

Flip top tables can be a great space saver. These tables are noted in the pricer by an "FT" at the end of the model number.

Round & Square

Availability varies by series. Other options, such as casters, may dictate which sizes are available.

Rectangle & Kidney Bean

Available on VertiGo series H-based tables.



	00 - Ultra	01 - Foundation	02 - Fundamental	06 - Stretch	08 - Elite	33 - Element	44 - Primary	45 - Puddle	71 - Exclaim	74 - VertiGo	99 - Surge
Nesting Options											
Flip Top X		•	•	•	•	•				•	•

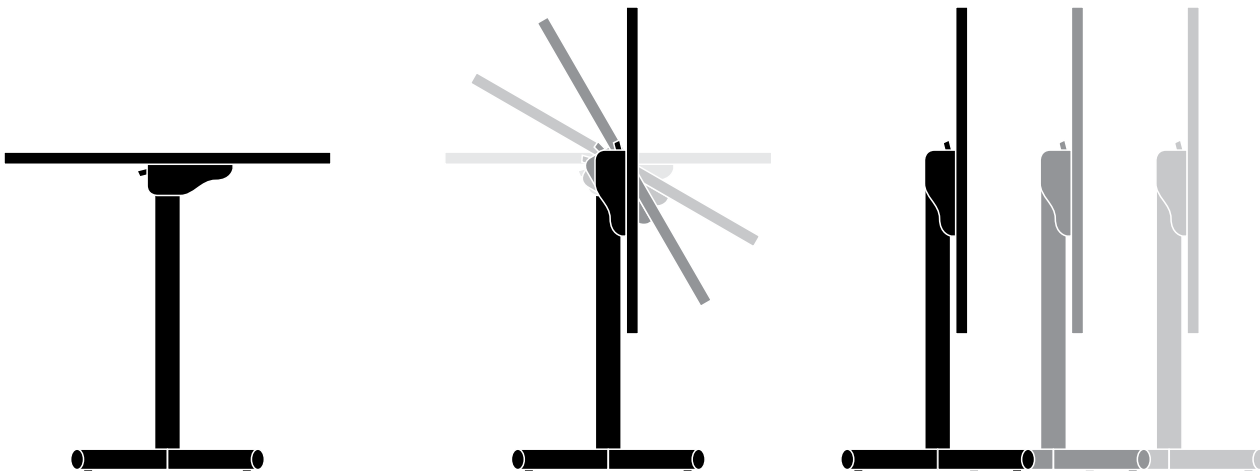

Folding T-bases and TT-bases

Rectangular, racetrack, and some round tables fold for easy storage. These tables are noted in the pricer by an "FD" at the end of the model number.

Standard Folding

Racetrack and rectangular tables 60" and longer use two standard folding mechanisms. Bases fold toward each other and end up toe-to-toe for a total thickness of 4.75" per table.

Short Folding

All round tables and any rectangular tables 48" long or less use a short fold mechanism. Bases fold one over the other for a total thickness of 6.75" per table.

Storage Table Carts

Carts to help store and move tables are available. See pricing below.



	00 - Ultra	01 - Foundation	02 - Fundamental	06 - Stretch	08 - Elite	33 - Element	44 - Primary	45 - Puddle	71 - Exclaim	74 - VeriGo	99 - Surge
Folding Options											
Folding T	•	•	•	•	•	•					•
Folding TT	•	•	•	•	•	•					

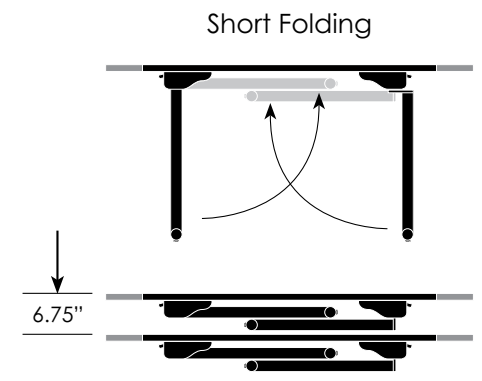
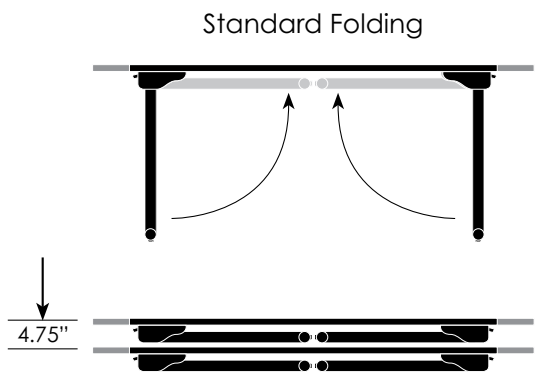

Folding Table Carts

Table Shape	Max Table	Capacity	Model Number	Finish	Price	Mobile Carts
Round	60"	Four short-fold tables	STC-RD60	01 Structured Black	\$ 1,828	
Rectangle	30 x 60"	Six folding tables	STC-TC60	01 Structured Black	1,821	
	30 x 72"	Six folding tables	STC-TC72	01 Structured Black	2,012	
	30 x 84"	Six folding tables	STC-TC84	01 Structured Black	2,042	
	30 x 96 *"	Six folding tables	STC-TC96	01 Structured Black	2,186	

RC 3" Radius Corners

3" radius corners soften the corner of tables to give them a smooth feel. Upcharge is \$61 per table.

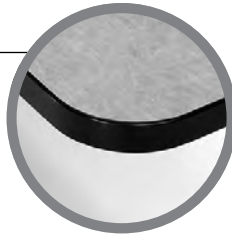

MARKER Markerboard Laminates

White markerboard laminate can be specified on any table for an upcharge of \$111 per table. We suggest pairing this with a dark 3mm edge. Call customer service for custom quotes on other markerboard laminates.



GR Grommets

Grommets can be added to most table shapes for an upcharge of \$45 each. Simply add "-GR" to your model number. 60 mm radius hole. Available in black. See page 227 for location details.

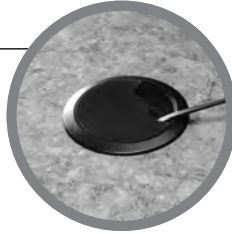

MP Modesty & Privacy Panels

Modesty & privacy panels can be added to many table sizes, and some can also be used on folding and nesting models.

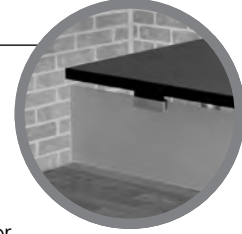

Available in laminate, metal, frosted acrylic, and mesh. See pages 204-207 for complete selection and pricing.

SOLID Solid Surface Tops

Need something a little more substantial? We can offer solid surface tops on many of our tables. These are quite popular on disc and X-based cafe tables. Call customer service for a custom quote. Leadtime on solid surface is usually around 6 weeks.

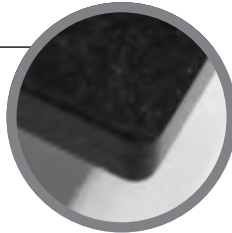

LOGO Custom Logo Tops

Make your laminate table top the focal point of any room by adding your logo in full color. Working with Wilsonart, we can add logos that utilize standard laminates into the background and integrate them into the logos themselves.



This process requires a custom quote, and does require an extended leadtime, but the final results are worth it.

QG Quick-Connect Ganging Brackets

Easily connect and disconnect tables or tables of any shape for simple room configurations. Quick to install and built to last, these table connectors will provide clients with durability and functionality for years to come. These allow for seamless assembly and handling with a low profile design. Upcharge is \$45 (includes 4 connectors per table).



LC Locking Casters

2" locking casters can be added to most tables for an upcharge of \$111 per set of four. Check product details for availability.



Note: nesting tables are priced with locking casters included.

PHK Bag Hooks

Accessory hooks are great for hanging coats and purses. This is a simple add on item that works on practically any table. \$12 list each.



Model #	Description	List Price
#LC	2" locking caster – standard (black)	\$111
#LC-SC	2" locking caster (silver & black)	\$111
#LC1.5	1.5" low-profile locking caster	\$111
#SLC.3	3" locking 'soft' caster for hard floors	\$147

CCG Concealed Casters

Concealed casters can be specified on one side of a T-based table. Other side will have standard glides. Overall height remains at 29". Upcharge is \$137 per table.

Only available on Foundation, Fundamental, & Element series. (Foundation uses black end cap as pictured.)

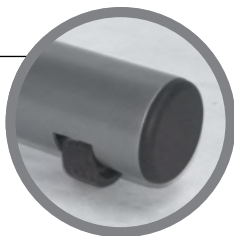

WM Built-in Wire Management

One of two T-bases will have a 1x19" steel access door with self closing hinges. Door height can vary depending on other specified options. Check series details for availability. Upcharge is \$139 per column. See page 226 for details. Not available in chrome.



OS Offset T-bases

Most T-bases can be upgraded to offset T-bases. The standard offset is 3". Check product details for availability. Upcharges vary based on series.

Not available on any 18"d tables. Not available on 30"d nesting tables less than 60" wide.

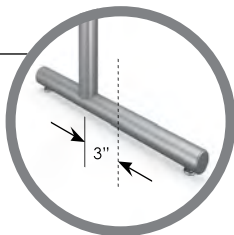

WM LC Snap-on Wire Management Leg Cover

Snaps on to round columns and offers coverage of wires down the leg. Powdercoated steel to match base color. Check series details for compatibility. Upcharge is \$50 for 2" and \$79 for 3" (Surge & Puddle Series). See page 226 for details. Not available in chrome.

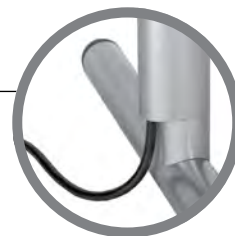

EM Edge Mounted T-bases

T-bases and TT-bases can be specified as edge mounted bases on most static models for \$76. Bases on tables 36-48" in length are already edge mounted.

The position of bases on folding and nesting tables cannot be adjusted.

Table Length	EM
36-48"	standard
60-96"	\$76

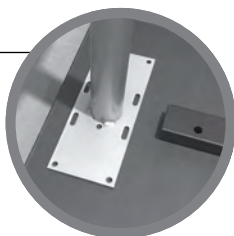

MM LC Magnetic Wire Management Leg Cover

Magnetically attaches to rectangular and square columns and offers coverage of wires down the leg. Powdercoated steel to match base color. Check series details for compatibility. Upcharge is \$71 each. See page 226 for details.

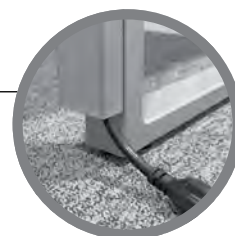

CH Chrome Finish

Chrome finish is a premium finish available on select models. Check product details for availability. Upcharges vary based on series and number of bases.

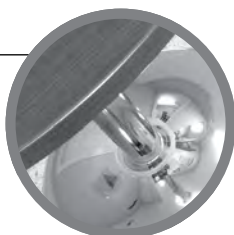

PB Powerbox Mounting Plate

The powerbox is ideal for round and square tables that have a power unit centered in the top. This U-shaped mounting plate allows 2.75x8x12" for the unit itself, wire management through the column, and a hole out the side and bottom of the column. Available on most X-bases and disc bases for \$100 upcharge. \$329 list upcharge on BWE - Bottom Cord Exit on 44 or 99 disc bases.

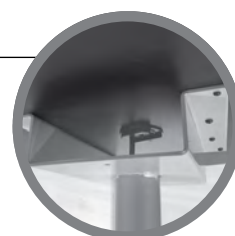

FM LB Floor Mount Leveler Brackets

These brackets are available only as an add-on to our bases and are not for individual sale. Floor mounting hardware not included. Upcharge is \$100 per table.



BWE Bottom Cord Exit

Wires are slipped through the column from the mounting plate to the floor. Only available on 44 or 99 disc bases. Upcharge is \$132.

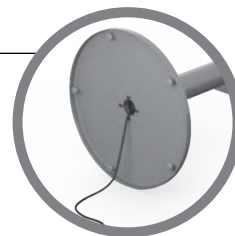

SH Special Height

Special height tables can be specified in most series. Standard height is 29". Upcharges vary based on base and height needed.

Tables larger than 36x72" will need a stretcher bar between the bases. Contact customer service to quote these tables.

When specifying, include your custom height in the model number. For example: (-SH.42) for special height of 42".

Upcharges vary based on base and height needed, see individual series for pricing.

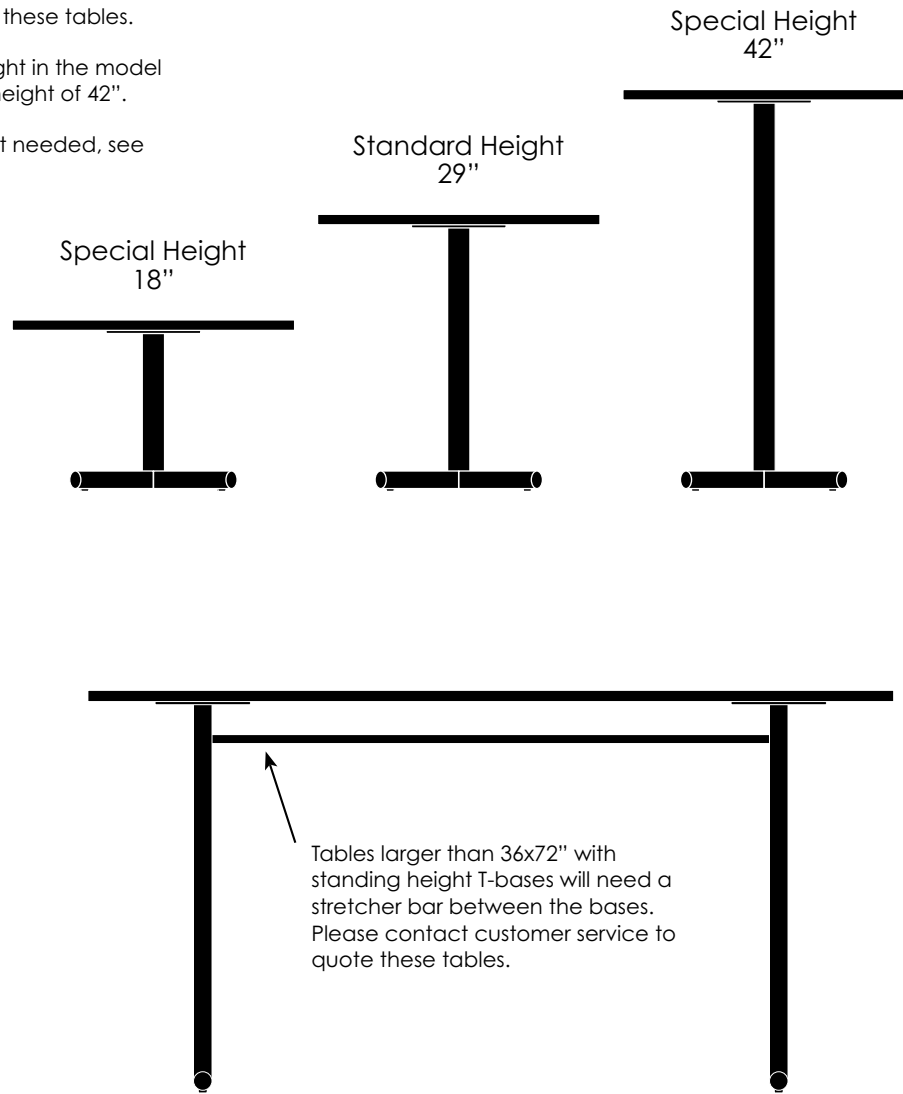

Tables larger than 36x72" with standing height T-bases will need a stretcher bar between the bases. Please contact customer service to quote these tables.

FR Footring

A footring is available on disc bases and select X-bases that are at standing height. Check product details for availability. Upcharge is \$166 per base. Not available in chrome.

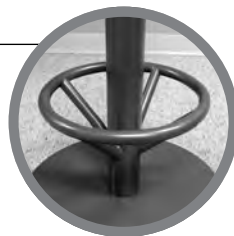



	00 - Ultra	01 - Foundation	02 - Fundamental	06 - Stretch	08 - Elite	33 - Element	44 - Primary	45 - Puddle	71 - Exclaim	74 - VeriGo	99 - Surge
Height Adjustable Options											
Ratchet											•
Counterbalance							•	•		•	•
Short Balance							•	•		•	•
Pneumatic		•	•				•	•			
Hand Crank										•	
Electric										•	•
Manual Ext. Height		•	•				•				

EH Electric Height

Electric height adjustability gives you the height range of the counterbalanced option, but is available in a wider variety of top shapes and sizes. The memory keypad remembers your four favorite heights. Available in both VeriGo and Surge.



EX Manual Extended Height

This base has the ability to manually change height in 1" increments by removing and re-inserting its bolts. Table height range of 26-42". Available in Foundation (T-bases), Fundamental (T-bases), and Primary series (2" column only).

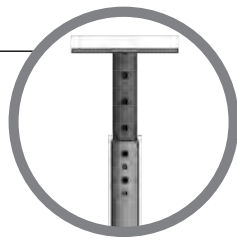

BL Counterbalanced

Need to get the most out of your height adjustable tables? The counterbalanced option is the way to go. Simply squeeze the small handle underneath and gently move the top to your desired height. With a range over 17" and unlimited choices in between, it's just that easy.

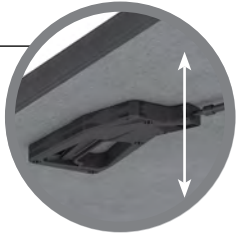

BLS Short Balanced

Go from coffee table height to standard height with the Short Balanced. Simply squeeze the small handle underneath and gently move the top to your desired height. Approximately 18-29".

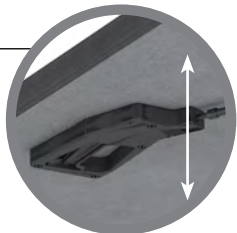

CR Hand Crank

Need the flexibility of infinite adjustability without the budget for counterbalanced bases? Our manual hand crank offers a cost-effective alternative. Only available in the VeriGo series and available on some nesting models.



NU Pneumatic

Most square (max 36") and round (max 42") tables are available with pneumatic height adjustability. 12" range in 1" increments. Upcharge is \$387 on X and disc bases.

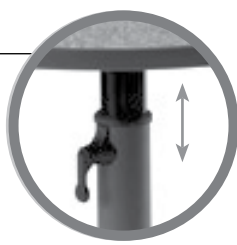

RA Ratchet

Ratchet height adjustability is available on select VeriGo tables. With a range of 9.45," the ratchet works in thirteen increments of .78". To reset to the lowest position, just lift past its highest point. Ratchet height adjustable bases are also available on some nesting tables.

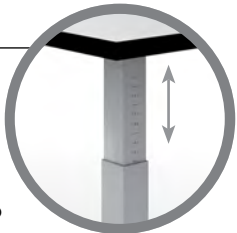

General Guidelines for Seating Capacities

- Allow about 30"/person
- Allow 48" for aisles between tables. ADA has 36" min.
- Allow 96"-120" between presenter and front row.
- Rooms with only one entrance are restricted to accommodate a maximum of 50 people (per fire code).
- Space required for single wheelchair passage is 36" min. and 60" min. for double wheelchair.
- Space required to turn a wheelchair is 60" dia.
- Newer wheelchair arms are designed to fit under standard 29"h tables (older models require an extra 2.5" of clearance)
- ADA Minimum table depth of 24".
- Ganging Wedges are not recommended for seating if top is not supported by a base.
- Capacities are based upon a 30" minimum width per seat. This chart is only a guideline which can vary based upon seating design and table layout.



Rectangle						Racetrack				Elliptical			
18 x 30	1												
18 x 36	1	30 x 36	2										
18 x 48	1	30 x 48	2 - 4										
										30 x 54	4		
18 x 60	2	30 x 60	4	48 x 60	6	36 x 60	4			30 x 60	4		
18 x 72	3	30 x 72	6	48 x 72	6 - 8	36 x 72	4					42 x 72	6
18 x 84	4	30 x 84	6	48 x 84	6 - 8	36 x 84	6					42 x 84	6 - 8
18 x 90	4	30 x 90	6	48 x 90	8	36 x 90	8					42 x 90	8
18 x 96	4 - 5	30 x 96	8	48 x 96	8 - 10	36 x 96	6 - 8					42 x 96	8 - 10
				48 x 120	10 - 12			54 x 120	10 - 12			42 x 120	10 - 12
				48 x 144	12			54 x 144	12			42 x 144	12
20 x 36	2												
20 x 48	2	36 x 48	2 - 4										
20 x 60	2 - 3	36 x 60	4 - 6	54 x 60	6					36 x 60	4		
20 x 72	3	36 x 72	6 - 8	54 x 72	8					36 x 72	4	48 x 72	6
20 x 84	4	36 x 84	6 - 8	54 x 84	8	42 x 84	6 - 8			36 x 84	6	48 x 84	6 - 8
20 x 90	4	36 x 90	8	54 x 90	8	42 x 90	8			36 x 90	8	48 x 90	8
20 x 96	4 - 5	36 x 96	8 - 10	54 x 96	8 - 10	42 x 96	8 - 10			36 x 96	6 - 8	48 x 96	8 - 10
				54 x 120	10 - 12	42 x 120	10 - 12	60 x 120	10 - 12			48 x 120	10 - 12
				54 x 144	12	42 x 144	12	60 x 144	12			48 x 144	12
24 x 36	1												
24 x 48	1												
24 x 60	2	42 x 60	6 - 8										
24 x 72	3	42 x 72	6 - 8	60 x 72	8								
24 x 84	4	42 x 84	6 - 8	60 x 84	8	48 x 84	6 - 8						
24 x 90	4	42 x 90	8	60 x 90	8	48 x 90	8						
24 x 96	4 - 5	42 x 96	8 - 10	60 x 96	8 - 10	48 x 96	8 - 10						
				42 x 120	10 - 12	48 x 120	10 - 12						
				42 x 144	12	48 x 144	12						

Square		Round	
24 x 24	2	24 x 24	2
30 x 30	2	30 x 30	2
36 x 36	4	36 x 36	3
42 x 42	4	42 x 42	4
48 x 48	4	48 x 48	4 - 5
54 x 54	4 - 8	54 x 54	5
60 x 60	4 - 8	60 x 60	6 - 7



D-shaped

24 x 36	1	42 x 60	5 - 7
24 x 48	1	42 x 72	5 - 7
24 x 60	2	42 x 84	5 - 7
24 x 72	3	42 x 90	7
24 x 84	3	42 x 96	7 - 9
24 x 90	3	48 x 60	5 - 7
24 x 96	2 - 3	48 x 72	5 - 7
30 x 48	2 - 3	48 x 84	5 - 7
30 x 60	3	48 x 90	7
30 x 72	5	48 x 96	7 - 9
30 x 84	5	54 x 54	4
30 x 90	5	54 x 60	6
30 x 96	7	54 x 72	8
36 x 48	2 - 3	54 x 84	8
36 x 60	3 - 5	54 x 90	8
36 x 72	5 - 7	54 x 96	8 - 10
36 x 84	5 - 7	54 x 120	10 - 12
36 x 90	7	54 x 144	12
36 x 96	7 - 9	60 x 60	6
		60 x 72	8
		60 x 84	8
		60 x 90	8
		60 x 96	8 - 10
		60 x 120	10 - 12
		60 x 144	12



Boat-shaped

30 x 42 x 84	6 - 8
30 x 42 x 90	8
30 x 42 x 96	8 - 10
36 x 48 x 84	6 - 8
36 x 48 x 90	8
36 x 48 x 96	8 - 10
36 x 48 x 120	10 - 12
36 x 48 x 144	12
48 x 54 x 120	10 - 12
48 x 54 x 144	12
54 x 60 x 120	10 - 12
54 x 60 x 144	12



Squircle

24 x 24	2
30 x 30	2
36 x 36	4
42 x 42	4
48 x 48	4



Half Round

18 x 36	1 - 2
24 x 48	2
30 x 60	3
36 x 72	4



Trapezoid

24 x 48	4 - 5
24 x 72	4 - 5
30 x 60	4 - 5
36 x 72	4 - 5

tableX

QS tableXPRESS

price list

Effective October 1, 2023





Need tables quickly? TableX can ship the following models in just 7-10 business days after receipt of clean order. We now offer silver powder coated Foundation T-bases, Surge disc or Primary square column bases, and you may choose any of our standard laminates and 3mm PVC edges to create the look your client is seeking. (Maximum order = 25 tables)

Foundation T, Surge Disc & Primary square column

Base Standards

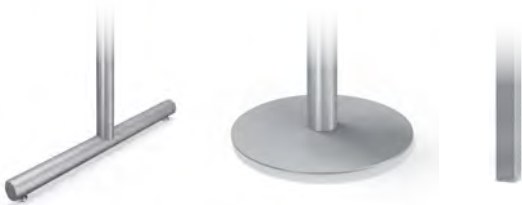

Standard Glides



Edge Options

Standard Finish Options



Laminates:
All standards are available. See pages 8-9 for current list.

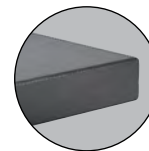

3mm Edges:
All standards are available. See page 10 for current list.

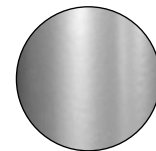

Bases:
37 Satin Silver

Top Shapes



Rectangle p.25



Racetrack p.26



Square p.25



Round p.25



Modesty Panels p.27



Rectangular with T-bases

Top Size	Base	Model Number	3P
24 x 36	Static	QS-01TC2436T20-3P	707
24 x 48	Static	QS-01TC2448T20-3P	766
24 x 60	Static	QS-01TC2460T20-3P	793
24 x 72	Static	QS-01TC2472T20-3P	843
24 x 84	Static	QS-01TC2484T20-3P	1,026
30 x 60	Static	QS-01TC3060T26-3P	849
30 x 72	Static	QS-01TC3072T26-3P	906
30 x 84	Static	QS-01TC3084T26-3P	1,129
36 x 60	Static	QS-01TC3660T26-3P	970
36 x 72	Static	QS-01TC3672T26-3P	1,025
36 x 84	Static	QS-01TC3684T26-3P	1,268



Rectangular with corner-mount square columns

Top Size	Base	Model Number	3P
24 x 36	Static	QS-44TC2436QC.2COR-3P	1,008
24 x 48	Static	QS-44TC2448QC.2COR-3P	1,066
24 x 60	Static	QS-44TC2460QC.2COR-3P	1,178
24 x 72	Static	QS-44TC2472QC.2COR-3P	1,229
30 x 60	Static	QS-44TC3060QC.2COR-3P	1,231
30 x 72	Static	QS-44TC3072QC.2COR-3P	1,288
36 x 60	Static	QS-44TC3660QC.2COR-3P	1,352
36 x 72	Static	QS-44TC3672QC.2COR-3P	1,407
36 x 84	Static	QS-44TC3684QC.2COR-3P	1,565



Square with thin round disc

Top Size	Base	Model Number	3P
30 x 30	Static	QS-99SQ3030D24-3P	899
30 x 30	Static	QS-99SQ3030D24-3P-SH.42	987
36 x 36	Static	QS-99SQ3636D24-3P	978
36 x 36	Static	QS-99SQ3636D24-3P-SH.42	1,066



Round with thin round disc

Top Size	Base	Model Number	3P
36 x 36	Static	QS-99RD36D24-3P	1,057
36 x 36	Static	QS-99RD36D24-3P-SH.42	1,145
42 x 42	Static	QS-99RD42D24-3P	1,181
42 x 42	Static	QS-99RD42D24-3P-SH.42	1,269

tableXpress



Square with corner mount square columns

Top Size	Base	Model Number	3P
30 x 30	Static	QS-44SQ3030QC.2COR-3P	1,015
36 x 36	Static	QS-44SQ3636QC.2COR-3P	1,094
42 x 42	Static	QS-44SQ4242QC.2COR-3P	1,188
48 x 48	Static	QS-44SQ4848QC.2COR-3P	1,295
60 x 60	Static	QS-44SQ6060QC.2COR-3P	1,677



Round with corner mount square columns

Top Size	Base	Model Number	3P
30 x 30	Static	QS-44RD30QC.2COR-3P	1,079
36 x 36	Static	QS-44RD36QC.2COR-3P	1,173
42 x 42	Static	QS-44RD42QC.2COR-3P	1,297
48 x 48	Static	QS-44RD48QC.2COR-3P	1,332
60 x 60	Static	QS-44RD60QC.2COR-3P	1,688



Racetrack with T-bases

Top Size	Base	Model Number	3P
36 x 72	Static	QS-01RT3672T26-3P	1,248
36 x 84	Static	QS-01RT3684T26-3P	1,579



Racetrack with disc bases

Top Size	Base	Model Number	3P
36 x 72	Static	QS-99RT3672D24-3P	2,021
36 x 72	Static	QS-99RT3672D24-3P-SH.42	2,197
36 x 84	Static	QS-99RT3684D24-3P	2,266
36 x 84	Static	QS-99RT3684D24-3P-SH.42	2,442



Adjustable height laptop table

Top Size	Base	Model Number	3P
12 x 18	Adjustable	QS-17RC1218C-AH-3P	854

Specifications:

Wilsonart D354-60 Designer White laminate
 D354 Designer White 3mm PVC edge

or

Wilsonart 7965K-12 Walnut Heights laminate
 Matching 3mm pvc edge



Laminate Modesty Panels

Size	Base	Model Number	3P
10 x 36	Static	QS-MP1036	163
10 x 48	Static	QS-MP1048	192
10 x 60	Static	QS-MP1060	220
10 x 72	Static	QS-MP1072	264
10 x 84	Static	QS-MP1084	292

tableXpress

tablex

ultra

00 ultra
price list

Effective October 1, 2023

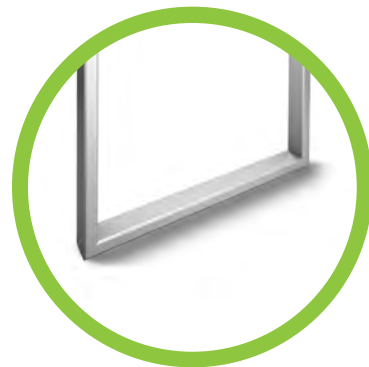



Sleek rectangular U-frame bases make a bold statement in our Ultra series. This stylish offering looks the part in a multitude of configurations, including a standing height option and locking casters.

Ultra Base Styles



U

Ultra Options

Standard
GlidesLocking
Casters

LC Locking Casters
can be added to any table for \$111 per set of four.

FD Folding Bases
are not available on Ultra tables.

NE Nesting Tables
are not available in the Ultra series.

FT Flip Tops
are not available on Ultra tables.

FM Floor Mount Leveler Brackets
are available for \$47 per table.

OS Offset T-bases
are not available on Ultra tables. Offset is not available on 18"d tables or 30"d nesting tables less than 60" wide.

CH Chrome Finish
is not available on Ultra tables.

WM Wire Management
Built-in wire management is not available on Ultra tables.

**MM
LC Magnetic Wire Management Leg Covers**
Magnetically attaches onto any square leg and are \$71 each.

SH Special Height
can be added to any table:
+ \$153 per base
Maximum height is 41".

Special height tables with tops larger than 36x72" must be custom quoted.

Ultra Top Shapes



Rectangle
p.32



Round
p.33

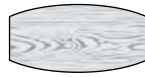

Boat
p.33



D-shaped
p.34

Ultra Top Options

GR Grommets
can be added to any table for \$45 each. To see specific locations, see page 227.

BB Maple Butcher Block
is 1.5" thick with food-grade clearcoat finish. Available in specific sizes with no grommets and clamp-on power only. Clamp-on power information can be found on page 219.

Call for pricing.

Edge Options

(corresponds with 3 columns of pricing)

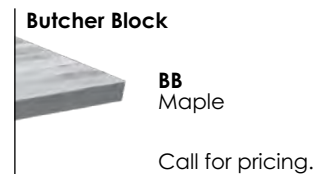
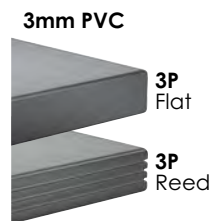

Rectangular with U-bases	Top Size	Base	Model Number	3P	3K	3W
	20 x 36	Static	00TC2036U18	\$ 911	\$ NA	\$1,157
	20 x 48	Static	00TC2048U18	969	NA	1,186
	20 x 60	Static	00TC2060U18	1,081	NA	1,300
	20 x 72	Static	00TC2072U18	1,132	NA	1,384
	20 x 84	Static	00TC2084U18	1,230	NA	1,520
	20 x 90 *	Static	00TC2090U18	1,288	NA	1,599
	20 x 96 *	Static	00TC2096U18	1,288	NA	1,614
	24 x 36	Static	00TC2436U22	936	NA	1,098
	24 x 48	Static	00TC2448U22	995	NA	1,191
	24 x 60	Static	00TC2460U22	1,107	NA	1,335
	24 x 72	Static	00TC2472U22	1,157	NA	1,419
	24 x 84	Static	00TC2484U22	1,255	NA	1,556
	24 x 90 *	Static	00TC2490U22	1,314	NA	1,634
	24 x 96 *	Static	00TC2496U22	1,314	NA	1,649
	30 x 36	Static	00TC3036U28	1,005	NA	1,186
	30 x 48	Static	00TC3048U28	1,077	NA	1,294
	30 x 60	Static	00TC3060U28	1,185	NA	1,432
	30 x 72	Static	00TC3072U28	1,242	NA	1,524
	30 x 84	Static	00TC3084U28	1,380	NA	1,704
	30 x 90 *	Static	00TC3090U28	1,452	NA	1,798
	30 x 96 *	Static	00TC3096U28	1,452	NA	1,813
	36 x 48	Static	00TC3648U34	1,160	NA	1,397
	36 x 60	Static	00TC3660U34	1,332	NA	1,606
	36 x 72	Static	00TC3672U34	1,386	NA	1,694
36 x 84	Static	00TC3684U34	1,504	NA	1,853	
36 x 90 *	Static	00TC3690U34	1,590	NA	1,962	
36 x 96 *	Static	00TC3696U34	1,590	NA	1,976	
42 x 60	Static	00TC4260U40	1,432	NA	1,728	
42 x 72	Static	00TC4272U40	1,535	NA	1,870	
42 x 84	Static	00TC4284U40	1,634	NA	2,007	
42 x 90 *	Static	00TC4290U40	1,730	NA	2,127	
42 x 96 *	Static	00TC4296U40	1,730	NA	2,141	
48 x 60	Static	00TC4860U46	1,485	NA	1,799	
48 x 72	Static	00TC4872U46	1,649	NA	2,007	
48 x 84	Static	00TC4884U46	1,659	NA	2,047	
48 x 90 *	Static	00TC4890U46	1,756	NA	2,168	
48 x 96 *	Static	00TC4896U46	1,756	NA	2,183	



Tables 36x72" and larger:  quote

* \$200 NET surcharge per order for oversized pallet

For Ultra table options, please reference pages 30-31.

Top Size	Base	Model Number	3P	3K	3W	Rectangular with 3 U-bases
42 x 120	Static	00TC42120U40U18-TJ	\$ 2,684	\$ NA	\$ 3,193	
42 x 144	Static	00TC42144U40U18-TJ	2,882	NA	3,468	
48 x 120	Static	00TC48120U46U18-TJ	2,721	NA	3,246	
48 x 144	Static	00TC48144U46U18-TJ	2,921	NA	3,523	

LC SH ← ⊗
 N/A quote 3 bases:

Top Size	Base	Model Number	3P	3K	3W	Round with 4 U-bases
48 x 48	Static	00RD48U18(4)	\$ 1,845	NA	\$ 2,076	
54 x 54	Static	00RD54U18(4)	2,048	NA	2,322	
60 x 60	Static	00RD60U18(4)	2,077	NA	2,376	

LC SH ← ⊗
 N/A quote 4 bases:

Top Size	Base	Model Number	3P	3K	3W	Boat-shaped with U-bases
30 x 42 x 84	Static	00BT3084U28	\$ 1,839	NA	\$ 2,195	
30 x 42 x 90 *	Static	00BT3090U28	1,977	NA	2,361	
30 x 42 x 96 *	Static	00BT3096U28	1,977	NA	2,376	
36 x 48 x 84	Static	00BT3684U34	2,001	NA	2,379	
36 x 48 x 90 *	Static	00BT3690U34	2,158	NA	2,566	
36 x 48 x 96 *	Static	00BT3696U34	2,158	NA	2,581	

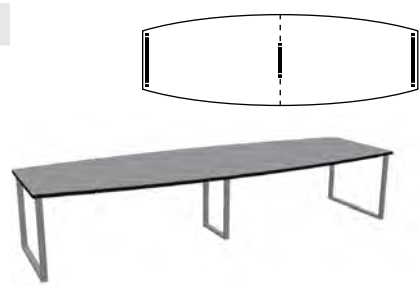
Top Size	Base	Model Number	3P	3K	3W	Boat-shaped with 3 U-bases
36 x 48 x 120	Static	00BT36120U34U18-TJ	\$ 3,228	NA	\$ 3,759	
36 x 48 x 144	Static	00BT36144U34U18-TJ	3,542	NA	4,162	

⊗ → LC SH
 3 bases: N/A quote

* \$200 NET surcharge per order for oversized pallet

For Ultra table options, please reference pages 30-31.

D-shaped with U-bases



Top Size	Base	Model Number	3P	3K	3W
24 x 36	Static	00D2436U22	\$ 994	NA	\$ 1,150
24 x 48	Static	00D2448U22	1,074	NA	1,266
24 x 60	Static	00D2460U22	1,239	NA	1,467
24 x 72	Static	00D2472U22	1,318	NA	1,584
24 x 84	Static	00D2484U22	1,398	NA	1,700
24 x 90 *	Static	00D2490U22	1,438	NA	1,758
24 x 96 *	Static	00D2496U22	1,478	NA	1,816
30 x 48	Static	00D3048U28	1,179	NA	1,390
30 x 60	Static	00D3060U28	1,364	NA	1,614
30 x 72	Static	00D3072U28	1,463	NA	1,752
30 x 84	Static	00D3084U28	1,563	NA	1,890
30 x 90 *	Static	00D3090U28	1,613	NA	1,959
30 x 96 *	Static	00D3096U28	1,662	NA	2,028
36 x 48	Static	00D3648U34	1,284	NA	1,515
36 x 60	Static	00D3660U34	1,489	NA	1,760
36 x 72	Static	00D3672U34	1,608	NA	1,920
36 x 84	Static	00D3684U34	1,728	NA	2,080
36 x 90 *	Static	00D3690U34	1,787	NA	2,160
36 x 96 *	Static	00D3696U34	1,847	NA	2,240
42 x 72	Static	00D4272U40	2,020	NA	2,382
42 x 84	Static	00D4284U40	2,020	NA	2,411
42 x 90 *	Static	00D4290U40	2,100	NA	2,512
42 x 96 *	Static	00D4296U40	2,178	NA	2,614
48 x 72	Static	00D4872U46	2,057	NA	2,431
48 x 84	Static	00D4884U46	2,057	NA	2,460
48 x 90 *	Static	00D4890U46	2,137	NA	2,562
48 x 96 *	Static	00D4896U46	2,216	NA	2,664



Tables 36x72" and larger: **SH** quote

* \$200 NET surcharge per order for oversized pallet

For Ultra table options, please reference pages 30-31.

ultra



For Ultra table options, please reference pages 30-31.

tablex

01 foundation
price list

Effective October 1, 2023





foundation

Any traditional table function can be accommodated with our competitively priced and cleanly styled Foundation tables. This series is perfect for any application and stands the test of time.

Foundation Base Styles



Foundation Options

- 

Standard Glides
- 

Locking Casters
- 

Concealed Casters
- 

Bullnose End
- LC Locking Casters** can be added to any table for \$111 per set of four.
- CCG Concealed Casters** available on one T-base for \$137 per table. Standard glides on opposite base.
- BN Bullnose End** available on all Foundation bases for \$73 per table.
- FD Folding Bases** priced accordingly with standard glides.
- NE Nesting Tables** priced accordingly with locking casters.
- FM Floor Mount Leveler Brackets** are available for \$47 per table.
- FT Flip Tops** available on X-based tables and are priced with standard glides.
- OS Offset T-bases** available for \$39 per table. Offset is not available on 18"d tables or 30"d nesting tables less than 60" wide.
- CH Chrome Finish** available for \$130 on most models. Upcharge for disc bases is \$499.
- WM Wire Management** Built-in wire management is available for \$139 per column. Specify inside or outside of column.
- WM LC Wire Management Leg Covers 2"** snap onto any leg and are \$50 each.
- SH Special Height** can be added to any table:
 + \$72 per column for heights > 29"
 + \$39 per column for heights < 29"
 Special height tables with tops larger than 36x72" must be custom quoted.
- FR Footring** available on standing height disc-bases for \$166 per base. Not available in chrome.
- PB Powerbox Mounting Plate** is available on disc & X-bases for \$100.

Foundation Height Adjustable Options

NU Pneumatic is available on X-bases for \$387 per table. For height option details, see page 19.

EX Manual Extended Height is available on T-bases for \$205 per table. For height option details, see page 19.

Foundation Top Shapes



Rectangle p.40



Boat p.43



Racetrack p.44



Elliptical p.45



Square p.46



Round p.47



D-shaped p.48



Half Round p.50



Trapezoid p.50



Squircle p.50

foundation

Foundation Top Options

QG Quick-Connect Ganging Brackets can be added to any table for \$45 (includes 4 connectors per table).





RC 3" Radius Corners can be added to any table for \$61.

GR Grommets can be added to any table for \$45 each. To see specific locations, see page 227.

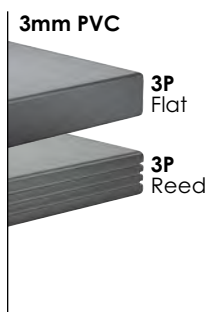
Foundation Edge Options

(corresponds with 3 columns of pricing)



Rectangular with T-bases	Top Size	Base	Model Number	3P	3K	3W
   	18 x 36	Static	01TC1836T16	\$ 660	\$ 729	\$ 803
		Nesting	01TC1836T18NE	1,480	1,549	1,623
	18 x 48	Static	01TC1848T16	705	796	881
		Folding	01TC1848T16FD	1,021	1,112	1,197
		Nesting	01TC1848T18NE	1,525	1,616	1,701
	18 x 60	Static	01TC1860T16	750	863	959
		Folding	01TC1860T16FD	1,078	1,191	1,287
		Nesting	01TC1860T18NE	1,569	1,683	1,779
	18 x 72	Static	01TC1872T16	794	929	1,037
		Folding	01TC1872T16FD	1,122	1,258	1,365
		Nesting	01TC1872T18NE	1,854	1,990	2,097
	18 x 84	Static	01TC1884T16	924	1,081	1,200
		Folding	01TC1884T16FD	1,167	1,325	1,443
		Nesting	01TC1884T18NE	1,899	2,057	2,175
	18 x 90 *	Static	01TC1890T16	968	1,148	1,263
		Folding	01TC1890T16FD	1,211	1,392	1,506
		Nesting	01TC1890T18NE	1,944	2,124	2,238
	18 x 96 *	Static	01TC1896T16	968	1,148	1,277
Folding		01TC1896T16FD	1,211	1,392	1,521	
Nesting		01TC1896T18NE	1,944	2,124	2,253	
20 x 36	Static	01TC2036T18	704	794	856	
	Nesting	01TC2036T20NE	1,527	1,617	1,679	
20 x 48	Static	01TC2048T18	762	882	949	
	Folding	01TC2048T18FD	1,078	1,197	1,265	
	Nesting	01TC2048T20NE	1,585	1,705	1,772	
20 x 60	Static	01TC2060T18	789	922	1,008	
	Folding	01TC2060T18FD	1,118	1,251	1,336	
	Nesting	01TC2060T20NE	1,503	1,636	1,721	
20 x 72	Static	01TC2072T18	840	998	1,092	
	Folding	01TC2072T18FD	1,168	1,327	1,420	
	Nesting	01TC2072T20NE	1,904	2,062	2,156	
20 x 84	Static	01TC2084T18	1,023	1,230	1,313	
	Folding	01TC2084T18FD	1,266	1,474	1,557	
	Nesting	01TC2084T20NE	2,002	2,209	2,292	
20 x 90 *	Static	01TC2090T18	1,081	1,318	1,392	
	Folding	01TC2090T18FD	1,325	1,561	1,636	
	Nesting	01TC2090T20NE	2,060	2,297	2,371	
20 x 96 *	Static	01TC2096T18	1,081	1,318	1,406	
	Folding	01TC2096T18FD	1,325	1,561	1,650	
	Nesting	01TC2096T20NE	2,060	2,297	2,385	





* \$200 NET surcharge per order for oversized pallet



For Foundation series table options, please reference pages 38-39.

Top Size	Base	Model Number	3P	3K	3W	Rectangular with T-bases
24 x 36	Static	01TC2436T20	\$ 707	\$ 797	\$ 869	
	Nesting	01TC2436T22NE	1,527	1,617	1,689	
24 x 48	Static	01TC2448T20	766	885	962	
	Folding	01TC2448T20FD	1,081	1,201	1,278	
	Nesting	01TC2448T22NE	1,585	1,705	1,782	
24 x 60	Static	01TC2460T20	793	926	1,021	
	Folding	01TC2460T20FD	1,121	1,254	1,349	
	Nesting	01TC2460T22NE	1,613	1,746	1,840	
24 x 72	Static	01TC2472T20	843	1,002	1,105	
	Folding	01TC2472T20FD	1,172	1,330	1,433	
	Nesting	01TC2472T22NE	1,904	2,062	2,165	
24 x 84	Static	01TC2484T20	1,026	1,233	1,326	
	Folding	01TC2484T20FD	1,270	1,477	1,570	
	Nesting	01TC2484T22NE	2,002	2,209	2,302	
24 x 90 *	Static	01TC2490T20	1,085	1,321	1,405	
	Folding	01TC2490T20FD	1,328	1,565	1,649	
	Nesting	01TC2490T22NE	2,060	2,297	2,381	
24 x 96 *	Static	01TC2496T20	1,085	1,321	1,419	
	Folding	01TC2496T20FD	1,328	1,565	1,663	
	Nesting	01TC2496T22NE	2,060	2,297	2,395	
30 x 36	Static	01TC3036T26	754	866	934	
	Nesting	01TC3036T26NE	1,574	1,686	1,754	
30 x 48	Static	01TC3048T26	826	975	1,043	
	Folding	01TC3048T26FD	1,142	1,290	1,358	
	Nesting	01TC3048T26NE	1,646	1,794	1,863	
30 x 60	Static	01TC3060T26	849	1,008	1,096	
	Folding	01TC3060T26FD	1,177	1,337	1,425	
	Nesting	01TC3060T26NE	1,669	1,828	1,916	
30 x 72	Static	01TC3072T26	906	1,093	1,188	
	Folding	01TC3072T26FD	1,234	1,422	1,516	
	Nesting	01TC3072T26NE	1,966	2,154	2,248	
30 x 84	Static	01TC3084T26	1,129	1,386	1,453	
	Folding	01TC3084T26FD	1,372	1,629	1,697	
	Nesting	01TC3084T26NE	2,104	2,361	2,429	
30 x 90 *	Static	01TC3090T26	1,201	1,494	1,547	
	Folding	01TC3090T26FD	1,445	1,738	1,791	
30 x 96 *	Static	01TC3096T26	1,201	1,494	1,562	
	Folding	01TC3096T26FD	1,445	1,738	1,805	

* \$200 NET surcharge per order for oversized pallet



For Foundation series table options, please reference pages 38-39.

Rectangular with T-bases	Top Size	Base	Model Number	3P	3K	3W
    <p>Folding T Nesting T</p>	36 x 48	Static	01TC3648T26	\$ 884	\$ 1,060	\$ 1,120
		Folding	01TC3648T26FD	1,199	1,376	1,436
		Nesting	01TC3648T26NE	1,844	2,020	2,080
	36 x 60	Static	01TC3660T26	970	1,190	1,244
		Folding	01TC3660T26FD	1,298	1,519	1,572
		Nesting	01TC3660T26NE	2,004	2,224	2,278
	36 x 72	Static	01TC3672T26	1,025	1,272	1,333
		Folding	01TC3672T26FD	1,353	1,600	1,661
		Nesting	01TC3672T26NE	2,085	2,332	2,393
	36 x 84	Static	01TC3684T26	1,268	1,574	1,617
		Folding	01TC3684T26FD	1,511	1,818	1,860
	36 x 90 *	Static	01TC3690T26	1,353	1,702	1,725
		Folding	01TC3690T26FD	1,597	1,946	1,968
	36 x 96 *	Static	01TC3696T26	1,353	1,702	1,739
		Folding	01TC3696T26FD	1,597	1,946	1,983

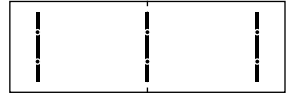

Rectangular with TT-bases	Top Size	Base	Model Number	3P	3K	3W
   <p>Nesting TT</p>	42 x 60	Static	01TC4260TT34	\$ 1,301	\$ 1,558	\$ 1,596
		Nesting	01TC4260TT34NE	2,457	2,715	2,753
	42 x 72	Static	01TC4272TT34	1,404	1,713	1,739
		Nesting	01TC4272TT34NE	2,560	2,869	2,895
	42 x 84	Static	01TC4284TT34	1,587	1,946	1,961
	42 x 90 *	Static	01TC4290TT34	1,683	2,089	2,080
	42 x 96 *	Static	01TC4296TT34	1,683	2,089	2,095
	48 x 60	Static	01TC4860TT36	1,328	1,600	1,641
		Nesting	01TC4860TT36NE	2,485	2,757	2,798
	48 x 72	Static	01TC4872TT36	1,492	1,845	1,850
		Nesting	01TC4872TT36NE	2,649	3,002	3,007
	48 x 84	Static	01TC4884TT36	1,587	1,946	1,975
	48 x 90 *	Static	01TC4890TT36	1,684	2,091	2,096
	48 x 96 *	Static	01TC4896TT36	1,684	2,091	2,111

* \$200 NET surcharge per order for oversized pallet

For Foundation series table options, please reference pages 38-39.

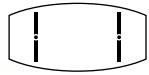

Top Size	Base	Model Number	3P	3K	3W	Rectangular with 3 TT-bases
42 x 120	Static	01TC42120TT34(3)-TJ	\$ 2,390	\$ 2,994	\$ 2,899	 
42 x 144	Static	01TC42144TT34(3)-TJ	2,588	3,290	3,174	
48 x 120	Static	01TC48120TT36(3)-TJ	2,402	3,012	2,927	
48 x 144	Static	01TC48144TT36(3)-TJ	2,602	3,312	3,204	

LC CH SH ⊗
 N/A +171 quote 3 bases:

Top Size	Base	Model Number	3P	3K	3W	Boat-shaped with T-bases
30 x 42 x 84	Static	01BT3084T26	\$ 1,628	\$ 2,115	\$ 1,984	 
30 x 42 x 90 *	Static	01BT3090T26	1,766	2,322	2,150	
30 x 42 x 96 *	Static	01BT3096T26	1,766	2,322	2,164	

foundation

Top Size	Base	Model Number	3P	3K	3W	Boat-shaped with TT-bases
36 x 48 x 84	Static	01BT3684TT34	\$ 1,980	\$ 2,535	\$ 2,358	 
36 x 48 x 90 *	Static	01BT3690TT34	2,137	2,771	2,545	
36 x 48 x 96 *	Static	01BT3696TT34	2,137	2,771	2,560	

Top Size	Base	Model Number	3P	3K	3W	Boat-shaped with 3 TT-bases
36 x 48 x 120	Static	01BT36120TT36(3)-TJ	\$ 2,960	\$ 3,848	\$ 3,491	 
36 x 48 x 144	Static	01BT36144TT36(3)-TJ	3,274	4,319	3,894	



LC CH SH ⊗
 N/A +171 quote 3 bases:

* \$200 NET surcharge per order for oversized pallet

For Foundation series table options, please reference pages 38-39.

Racetrack with T-bases	Top Size	Base	Model Number	3P	3K	3W
   	36 x 60	Static	01RT3660T26	\$ 1,288	\$ 1,648	\$ 1,553
		Nesting	01RT3660T26NE	2,208	2,568	2,473
	36 x 72	Static	01RT3672T26	1,288	1,648	1,582
		Folding	01RT3672T26FD	1,617	1,976	1,910
	36 x 84	Static	01RT3684T26	1,579	2,041	1,921
		Folding	01RT3684T26FD	1,822	2,284	2,165
	36 x 90 *	Static	01RT3690T26	1,713	2,242	2,084
		Folding	01RT3690T26FD	1,957	2,486	2,327
	36 x 96 *	Static	01RT3696T26	1,713	2,242	2,098
		Folding	01RT3696T26FD	1,957	2,486	2,342

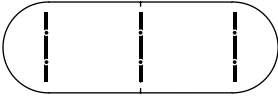
Racetrack with TT-bases	Top Size	Base	Model Number	3P	3K	3W
 	42 x 84	Static	01RT4284TT34	\$ 1,840	\$ 2,325	\$ 2,196
	42 x 90 *	Static	01RT4290TT34	1,981	2,537	2,366
	42 x 96 *	Static	01RT4296TT34	1,981	2,537	2,380
	48 x 84	Static	01RT4884TT34	2,137	2,771	2,531
	48 x 90 *	Static	01RT4890TT34	2,137	2,771	2,545
	48 x 96 *	Static	01RT4896TT34	2,137	2,771	2,560

Racetrack with 3 TT-bases	Top Size	Base	Model Number	3P	3K	3W
 	42 x 120	Static	01RT42120TT34(3)-TJ	\$ 2,943	\$ 3,822	\$ 3,463
	42 x 144	Static	01RT42144TT34(3)-TJ	3,254	4,289	3,863
	48 x 120	Static	01RT48120TT36(3)-TJ	2,960	3,849	3,491
	48 x 144	Static	01RT48144TT36(3)-TJ	3,275	4,320	3,894

 →
 LC
CH
SH
 3 bases: N/A +171 quote

* \$200 NET surcharge per order for oversized pallet

For Foundation series table options, please reference pages 38-39.

Top Size	Base	Model Number	3P	3K	3W	Elliptical with T-bases
30 x 54	Static	01EL3054T22	\$ 980	\$ 1,207	\$ 1,184	
30 x 60	Static	01EL3060T22	1,028	1,279	1,248	
36 x 60	Static	01EL3660T26	1,133	1,434	1,374	
36 x 72	Static	01EL3672T26	1,248	1,608	1,523	
36 x 84	Static	01EL3684T26	1,494	1,914	1,804	
36 x 90 *	Static	01EL3690T26	1,609	2,087	1,942	
36 x 96 *	Static	01EL3696T26	1,609	2,087	1,953	

Top Size	Base	Model Number	3P	3K	3W	Elliptical with TT-bases
42 x 72	Static	01EL4272TT26	\$ 1,552	\$ 1,971	\$ 1,850	
42 x 84	Static	01EL4284TT26	1,767	2,252	2,101	
42 x 90 *	Static	01EL4290TT26	1,911	2,468	2,271	
42 x 96 *	Static	01EL4296TT26	1,911	2,468	2,282	
48 x 72	Static	01EL4872TT30	1,705	2,182	2,026	
48 x 84	Static	01EL4884TT30	2,103	2,737	2,478	
48 x 90 *	Static	01EL4890TT30	2,103	2,737	2,490	
48 x 96 *	Static	01EL4896TT30	2,103	2,737	2,501	



Top Size	Base	Model Number	3P	3K	3W	Elliptical with 3 TT-bases
42 x 120	Static	01EL42120TT34(3)-TJ	\$ 2,943	\$ 3,822	\$ 3,423	
42 x 144	Static	01EL42144TT34(3)-TJ	3,254	4,289	3,811	
48 x 120	Static	01EL48120TT36(3)-TJ	2,960	3,849	3,454	
48 x 144	Static	01EL48144TT36(3)-TJ	3,275	4,320	3,845	



LC CH SH ← ⊗
 N/A +171 quote 3 bases:



* \$200 NET surcharge per order for oversized pallet

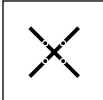

For Foundation series table options, please reference pages 38-39.

foundation



Square with X-base		Top Size	Base	Model Number	3P	3K	3W
   <p>Flip Top X</p>	24 x 24	Static	01SQ2424X22	\$ 577	\$ 638	\$ 704	
		Flip Top	01SQ2424X22FT	734	795	861	
	30 x 30	Static	01SQ3030X26	650	744	812	
		Flip Top	01SQ3030X26FT	807	900	969	
	36 x 36	Static	01SQ3636X32	751	885	951	
		Flip Top	01SQ3636X32FT	908	1,042	1,107	
	42 x 42	Static	01SQ4242X36	862	1,042	1,099	
		Flip Top	01SQ4242X36FT	1,095	1,275	1,332	
	48 x 48	Static	01SQ4848X38	992	1,226	1,269	





Square with 4-column X-base		Top Size	Base	Model Number	3P	3K	3W
 	54 x 54	Static	01SQ5454X36.4	\$ 1,402	\$ 1,697	\$ 1,720	
	60 x 60	Static	01SQ6060X42.4	1,579	1,941	1,939	

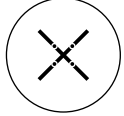

 →
  
 X.4: N/A +286

Square with TT-bases		Top Size	Base	Model Number	3P	3K	3W
   <p>Nesting TT</p>	48 x 48	Static	01SQ4848TT34	\$ 1,253	\$ 1,487	\$ 1,530	
		Nesting	01SQ4848TT34NE	2,448	2,682	2,725	



For Foundation series table options, please reference pages 38-39.

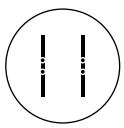

Top Size	Base	Model Number	3P	3K	3W	Round with X-base
24 x 24	Static	01RD24X22	\$ 617	\$ 698	\$ 724	   Flip Top X
	Flip Top	01RD24X22FT	774	855	881	
30 x 30	Static	01RD30X26	714	839	852	
	Flip Top	01RD30X26FT	870	996	1,008	
36 x 36	Static	01RD36X30	828	1,001	998	
	Flip Top	01RD36X30FT	985	1,158	1,155	
42 x 42	Static	01RD42X32	954	1,189	1,159	
	Flip Top	01RD42X32FT	1,188	1,423	1,393	
48 x 48	Static	01RD48X36	1,006	1,258	1,237	

Top Size	Base	Model Number	3P	3K	3W	Round with 4-column X-base
54 x 54	Static	01RD54X32.4	\$ 1,459	\$ 1,813	\$ 1,733	     N/A +286 X.4:
60 x 60	Static	01RD60X36.4	1,549	1,917	1,848	

Top Size	Base	Model Number	3P	3K	3W	Round with TT-bases
48 x 48	Static	01RD48TT26	\$ 1,217	\$ 1,470	\$ 1,448	   Folding TT
	Nesting	01RD48TT26NE	2,412	2,664	2,643	
54 x 54	Static	01RD54TT30	1,458	1,812	1,732	
	Nesting	01RD54TT30NE	2,653	3,007	2,927	
60 x 60	Static	01RD60TT34	1,521	1,890	1,821	
	Folding	01RD60TT34FD	2,248	2,616	2,547	
	Nesting	01RD60TT34NE	2,716	3,084	3,015	



For Foundation series table options, please reference pages 38-39.

D-shaped with T-bases	Top Size	Base	Model Number	3P	3K	3W
 	24 x 36	Static	01D2436T20	\$ 765	\$ 885	\$ 921
	24 x 48	Static	01D2448T20	845	1,004	1,037
	24 x 60	Static	01D2460T20	925	1,124	1,153
	24 x 72	Static	01D2472T20	1,004	1,243	1,270
	24 x 84	Static	01D2484T20	1,169	1,447	1,471
	24 x 90 *	Static	01D2490T20	1,209	1,507	1,529
	24 x 96 *	Static	01D2496T20	1,248	1,567	1,587
	30 x 48	Static	01D3048T26	928	1,127	1,139
	30 x 60	Static	01D3060T26	1,028	1,277	1,278
	30 x 72	Static	01D3072T26	1,127	1,426	1,416
	30 x 84	Static	01D3084T26	1,312	1,660	1,639
	30 x 90 *	Static	01D3090T26	1,361	1,735	1,708
	30 x 96 *	Static	01D3096T26	1,411	1,809	1,777
	36 x 48	Static	01D3648T26	1,008	1,247	1,238
	36 x 60	Static	01D3660T26	1,127	1,426	1,398
	36 x 72	Static	01D3672T26	1,247	1,605	1,558
	36 x 84	Static	01D3684T26	1,491	1,909	1,843
	36 x 90 *	Static	01D3690T26	1,551	1,999	1,924
	36 x 96 *	Static	01D3696T26	1,610	2,088	2,004



D-shaped with TT-bases	Top Size	Base	Model Number	3P	3K	3W
 	42 x 60	Static	01D4260TT34	\$ 1,889	\$ 2,441	\$ 2,222
	42 x 72	Static	01D4272TT34	1,889	2,441	2,251
	42 x 84	Static	01D4284TT34	1,974	2,526	2,364
	42 x 90 *	Static	01D4290TT34	2,053	2,644	2,466
	42 x 96 *	Static	01D4296TT34	2,132	2,763	2,567
	48 x 60	Static	01D4860TT36	1,900	2,458	2,246
	48 x 72	Static	01D4872TT36	1,900	2,458	2,274
	48 x 84	Static	01D4884TT36	1,985	2,543	2,388
	48 x 90 *	Static	01D4890TT36	2,065	2,662	2,490
	48 x 96 *	Static	01D4896TT36	2,144	2,781	2,592



* \$200 NET surcharge per order for oversized pallet

For Foundation series table options, please reference pages 38-39.

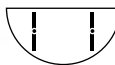
Top Size	Base	Model Number	3P	3K	3W	D-shaped with 4-column X-base
54 x 54	Static	01D5454X36.4	\$ 1,798	\$ 2,291	\$ 2,142	 
60 x 60	Static	01D6060X42.4	1,849	2,347	2,205	

 N/A
  +286
  X.4:

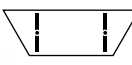
Top Size	Base	Model Number	3P	3K	3W	Half Round with T-bases
18 x 36	Static	01HR1836T16	\$ 773	\$ 898	\$ 909	  
24 x 48	Static	01HR2448T16	845	1,006	1,025	
	Nesting	01HR2448T16NE	1,665	1,826	1,845	
30 x 60	Static	01HR3060T20	1,026	1,276	1,261	
	Nesting	01HR3060T22NE	1,846	2,096	2,080	
36 x 72	Static	01HR3672T26	1,245	1,603	1,538	
	Nesting	01HR3672T26NE	2,205	2,563	2,498	

Top Size	Base	Model Number	3P	3K	3W	Trapezoid with T-bases
24 x 48	Static	01TZ2448T18	\$ 834	\$ 990	\$ 1,013	  
24 x 72	Static	01TZ2472T18	1,037	1,294	1,310	
	Nesting	01TZ2472T18NE	1,857	2,114	2,130	
30 x 60	Static	01TZ3060T22	973	1,196	1,202	
	Nesting	01TZ3060T22NE	1,793	2,016	2,022	
36 x 72	Static	01TZ3672T26	1,217	1,560	1,507	
	Nesting	01TZ3672T26NE	2,177	2,520	2,467	

* \$200 NET surcharge per order for oversized pallet

For Foundation series table options, please reference pages 38-39.

foundation

Squircle with X-base	Top Size	Base	Model Number	3P	3K	3W
   <p>FT Flip Top X</p>	24 x 24	Static	01SL24X22	\$ 802	\$ 976	\$ 952
		Flip Top	01SL24X22FT	959	1,133	1,109
	30 x 30	Static	01SL30X26	870	1,073	1,054
		Flip Top	01SL30X26FT	1,026	1,230	1,211
	36 x 36	Static	01SL36X32	959	1,196	1,179
		Flip Top	01SL36X32FT	1,116	1,353	1,335
	42 x 42	Static	01SL42X36	1,049	1,322	1,305
		Flip Top	01SL42X36FT	1,282	1,556	1,538
	48 x 48	Static	01SL48X38	1,159	1,477	1,453

For Foundation series table options, please reference pages 38-39.

For Foundation series table options, please reference pages 38-39.

tablex

02 fundamental
price list
Effective October 1, 2023





Large installations often dictate the need for a durable, versatile, and budget conscious table option. Fundamental meets these needs in addition to making installations easy.

fundamental

Fundamental Base Styles



Fundamental Options

Standard Glides



LC **Locking Casters**
can be added to any table for \$111 per set of four.

Locking Casters



CCG **Concealed Casters**
available on one T-base for \$137 per table. Standard glides on opposite base.

Concealed Casters



FD **Folding Bases**
priced accordingly with standard glides.

NE **Nesting Tables**
priced accordingly with locking casters.

FT **Flip Tops**
available on X-based tables and are priced with standard glides.

OS **Offset T-bases**
available for \$39 per table. Offset is not available on 18" d tables or 30" d nesting tables less than 60" wide.

CH **Chrome Finish**
available for \$130 on most models. Upcharge for disc bases is \$499.

WM **Wire Management**
Built-in wire management is available for \$139 per column. Specify inside or outside of column.

WM/LC **Wire Management Leg Covers 2"**
snap onto any leg and are \$50 each.

FM **Floor Mount Leveler Brackets**
are available for \$47 per table.

SH **Special Height**
can be added to any table:
+ \$72 per column for heights > 29"
+ \$39 per column for heights < 29"
Special height tables with tops larger than 36x72" must be custom quoted.

FR **Footring**
available on standing height disc-bases for \$166 per base. Not available in chrome.

PB **Powerbox Mounting Plate**
is available on disc & X-bases for \$100.

Fundamental Height Adjustable Options

NU Pneumatic is available on X-bases for \$387 per table. For height option details, see page 19.

EX Manual Extended Height is available on T-bases for \$205 per table. For height option details, see page 19.

Fundamental Top Shapes



Rectangle
p.56



Boat
p.59



Racetrack
p.60



Elliptical
p.61



Square
p.62



Round
p.63



D-shaped
p.64



Half Round
p.66



Trapezoid
p.66



Squirele
p.66

Fundamental Top Options

QG Quick-Connect Ganging Brackets can be added to any table for \$45 (includes 4 connectors per table).





RC 3" Radius Corners can be added to any table for \$61.

GR Grommets can be added to any table for \$45 each. To see specific locations, see page 227.

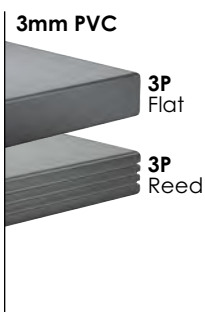
Fundamental Edge Options





(corresponds with 3 columns of pricing)



Rectangular with T-bases	Top Size	Base	Model Number	3P	3K	3W
   	18 x 36	Static	O2TC1836T16	\$ 651	\$ 706	\$ 794
		Nesting	O2TC1836T18NE	1,471	1,526	1,614
	18 x 48	Static	O2TC1848T16	696	769	872
		Folding	O2TC1848T16FD	1,012	1,084	1,188
		Nesting	O2TC1848T18NE	1,516	1,589	1,692
	18 x 60	Static	O2TC1860T16	740	831	950
		Folding	O2TC1860T16FD	1,069	1,160	1,278
		Nesting	O2TC1860T18NE	1,560	1,651	1,770
	18 x 72	Static	O2TC1872T16	785	893	1,028
		Folding	O2TC1872T16FD	1,113	1,222	1,356
		Nesting	O2TC1872T18NE	1,833	1,942	2,076
	18 x 84	Static	O2TC1884T16	915	1,041	1,190
		Folding	O2TC1884T16FD	1,158	1,284	1,434
		Nesting	O2TC1884T18NE	1,878	2,005	2,154
	18 x 90 *	Static	O2TC1890T16	959	1,103	1,254
		Folding	O2TC1890T16FD	1,202	1,347	1,497
		Nesting	O2TC1890T18NE	1,935	2,079	2,229
	18 x 96 *	Static	O2TC1896T16	959	1,103	1,268
Folding		O2TC1896T16FD	1,202	1,347	1,512	
Nesting		O2TC1896T18NE	1,935	2,079	2,244	
20 x 36	Static	O2TC2036T18	695	767	847	
	Nesting	O2TC2036T20NE	1,518	1,591	1,671	
20 x 48	Static	O2TC2048T18	753	849	940	
	Folding	O2TC2048T18FD	1,069	1,164	1,256	
	Nesting	O2TC2048T20NE	1,577	1,673	1,764	
20 x 60	Static	O2TC2060T18	780	887	999	
	Folding	O2TC2060T18FD	1,109	1,215	1,327	
	Nesting	O2TC2060T20NE	1,604	1,711	1,822	
20 x 72	Static	O2TC2072T18	831	958	1,083	
	Folding	O2TC2072T18FD	1,159	1,286	1,411	
	Nesting	O2TC2072T20NE	1,895	2,022	2,147	
20 x 84	Static	O2TC2084T18	1,014	1,180	1,304	
	Folding	O2TC2084T18FD	1,257	1,423	1,548	
	Nesting	O2TC2084T20NE	1,993	2,159	2,284	
20 x 90 *	Static	O2TC2090T18	1,072	1,261	1,383	
	Folding	O2TC2090T18FD	1,316	1,505	1,627	
	Nesting	O2TC2090T20NE	2,052	2,241	2,362	
20 x 96 *	Static	O2TC2096T18	1,072	1,261	1,397	
	Folding	O2TC2096T18FD	1,316	1,505	1,641	
	Nesting	O2TC2096T20NE	2,052	2,241	2,377	





* \$200 NET surcharge per order for oversized pallet

For Fundamental series table options, please reference pages 54-55.



Top Size	Base	Model Number	3P	3K	3W	Rectangular with T-bases
24 x 36	Static	02TC2436T20	\$ 698	\$ 771	\$ 860	   
	Nesting	02TC2436T22NE	1,518	1,591	1,680	
24 x 48	Static	02TC2448T20	757	853	953	
	Folding	02TC2448T20FD	1,073	1,168	1,269	
	Nesting	02TC2448T22NE	1,577	1,673	1,773	
24 x 60	Static	02TC2460T20	784	891	1,012	
	Folding	02TC2460T20FD	1,113	1,219	1,340	
	Nesting	02TC2460T22NE	1,604	1,711	1,832	
24 x 72	Static	02TC2472T20	835	961	1,096	
	Folding	02TC2472T20FD	1,163	1,290	1,425	
	Nesting	02TC2472T22NE	1,895	2,022	2,157	
24 x 84	Static	02TC2484T20	1,017	1,183	1,318	
	Folding	02TC2484T20FD	1,261	1,427	1,561	
	Nesting	02TC2484T22NE	1,993	2,159	2,293	
24 x 90 *	Static	02TC2490T20	1,076	1,265	1,396	
	Folding	02TC2490T20FD	1,319	1,509	1,640	
	Nesting	02TC2490T22NE	2,052	2,241	2,372	
24 x 96 *	Static	02TC2496T20	1,076	1,265	1,411	
	Folding	02TC2496T20FD	1,319	1,509	1,654	
	Nesting	02TC2496T22NE	2,052	2,241	2,386	
30 x 36	Static	02TC3036T26	745	835	926	
	Nesting	02TC3036T26NE	1,565	1,655	1,746	
30 x 48	Static	02TC3048T26	818	936	1,034	
	Folding	02TC3048T26FD	1,133	1,252	1,350	
	Nesting	02TC3048T26NE	1,638	1,756	1,854	
30 x 60	Static	02TC3060T26	840	968	1,088	
	Folding	02TC3060T26FD	1,169	1,296	1,416	
	Nesting	02TC3060T26NE	1,660	1,788	1,908	
30 x 72	Static	02TC3072T26	897	1,047	1,179	
	Folding	02TC3072T26FD	1,226	1,376	1,507	
	Nesting	02TC3072T26NE	1,958	2,108	2,239	
30 x 84	Static	02TC3084T26	1,120	1,326	1,445	
	Folding	02TC3084T26FD	1,364	1,569	1,688	
	Nesting	02TC3084T26NE	2,096	2,301	2,420	
30 x 90 *	Static	02TC3090T26	1,193	1,427	1,539	
	Folding	02TC3090T26FD	1,436	1,671	1,782	
30 x 96 *	Static	02TC3096T26	1,193	1,427	1,553	
	Folding	02TC3096T26FD	1,436	1,671	1,797	

* \$200 NET surcharge per order for oversized pallet

For Fundamental series table options, please reference pages 54-55.



Rectangular with T-bases	Top Size	Base	Model Number	3P	3K	3W
   	36 x 48	Static	02TC3648T26	\$ 875	\$ 1,016	\$ 1,112
		Folding	02TC3648T26FD	1,191	1,332	1,427
		Nesting	02TC3648T26NE	1,835	1,977	2,072
	36 x 60	Static	02TC3660T26	961	1,138	1,235
		Folding	02TC3660T26FD	1,290	1,466	1,564
		Nesting	02TC3660T26NE	1,995	2,171	2,269
	36 x 72	Static	02TC3672T26	1,016	1,214	1,324
		Folding	02TC3672T26FD	1,344	1,542	1,653
		Nesting	02TC3672T26NE	2,077	2,274	2,385
	36 x 84	Static	02TC3684T26	1,259	1,504	1,608
		Folding	02TC3684T26FD	1,503	1,748	1,852
	36 x 90 *	Static	02TC3690T26	1,345	1,624	1,716
		Folding	02TC3690T26FD	1,588	1,868	1,960
	36 x 96 *	Static	02TC3696T26	1,345	1,624	1,731
		Folding	02TC3696T26FD	1,588	1,868	1,974

fundamental



Rectangular with TT-bases	Top Size	Base	Model Number	3P	3K	3W
  	42 x 60	Static	02TC4260TT34	\$ 1,307	\$ 1,513	\$ 1,603
		Nesting	02TC4260TT34NE	2,464	2,670	2,760
	42 x 72	Static	02TC4272TT34	1,410	1,658	1,745
		Nesting	02TC4272TT34NE	2,567	2,814	2,902
	42 x 84	Static	02TC4284TT34	1,594	1,881	1,967
	42 x 90 *	Static	02TC4290TT34	1,690	2,015	2,087
	42 x 96 *	Static	02TC4296TT34	1,690	2,015	2,101
	48 x 60	Static	02TC4860TT36	1,335	1,552	1,648
		Nesting	02TC4860TT36NE	2,492	2,709	2,805
	48 x 72	Static	02TC4872TT36	1,499	1,781	1,857
		Nesting	02TC4872TT36NE	2,655	2,938	3,013
	48 x 84	Static	02TC4884TT36	1,594	1,881	1,982
	48 x 90 *	Static	02TC4890TT36	1,691	2,017	2,103
	48 x 96 *	Static	02TC4896TT36	1,691	2,017	2,117



* \$200 NET surcharge per order for oversized pallet

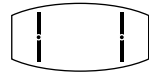

For Fundamental series table options, please reference pages 54-55.

Top Size	Base	Model Number	3P	3K	3W	Rectangular with 3 TT-bases
42 x 120	Static	02TC42120TT34(3)-TJ	\$ 2,400	\$ 2,883	\$ 2,909	 
42 x 144	Static	02TC42144TT34(3)-TJ	2,598	3,160	3,184	
48 x 120	Static	02TC48120TT36(3)-TJ	2,412	2,900	2,937	
48 x 144	Static	02TC48144TT36(3)-TJ	2,612	3,180	3,214	

LC CH SH ⊗
 N/A +171 quote 3 bases:

Top Size	Base	Model Number	3P	3K	3W	Boat-shaped with T-bases
30 x 42 x 84	Static	02BT3084T26	\$ 1,620	\$ 2,009	\$ 1,976	 
30 x 42 x 90 *	Static	02BT3090T26	1,757	2,202	2,142	
30 x 42 x 96 *	Static	02BT3096T26	1,757	2,202	2,156	

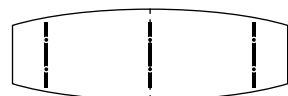
Top Size	Base	Model Number	3P	3K	3W	Boat-shaped with TT-bases
36 x 48 x 84	Static	02BT3684TT34	\$ 1,987	\$ 2,431	\$ 2,365	 
36 x 48 x 90 *	Static	02BT3690TT34	2,144	2,651	2,552	
36 x 48 x 96 *	Static	02BT3696TT34	2,144	2,651	2,566	

Top Size	Base	Model Number	3P	3K	3W	Boat-shaped with 3 TT-bases
36 x 48 x 120	Static	02BT36120TT36(3)-TJ	\$ 2,970	\$ 3,681	\$ 3,501	 
36 x 48 x 144	Static	02BT36144TT36(3)-TJ	3,284	4,120	3,904	



LC CH SH ⊗
 N/A +171 quote 3 bases:



* \$200 NET surcharge per order for oversized pallet

For Fundamental series table options, please reference pages 54-55.

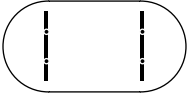
fundamental

Race-track with T-bases	Top Size	Base	Model Number	3P	3K	3W
    <p>Folding T Nesting T</p>	36 x 60	Static	02RT3660T26	\$ 1,240	\$ 1,527	\$ 1,505
		Nesting	02RT3660T26NE	2,200	2,487	2,465
	36 x 72	Static	02RT3672T26	1,240	1,527	1,533
		Folding	02RT3672T26FD	1,568	1,856	1,862
		Nesting	02RT3672T26NE	2,274	2,561	2,567
	36 x 84	Static	02RT3684T26	1,570	1,940	1,913
		Folding	02RT3684T26FD	1,814	2,183	2,156
	36 x 90 *	Static	02RT3690T26	1,705	2,128	2,075
		Folding	02RT3690T26FD	1,948	2,371	2,319
	36 x 96 *	Static	02RT3696T26	1,705	2,128	2,090
		Folding	02RT3696T26FD	1,948	2,371	2,333

Race-track with TT-bases	Top Size	Base	Model Number	3P	3K	3W
 	42 x 84	Static	02RT4284TT34	\$ 2,163	\$ 2,551	\$ 2,519
	42 x 90 *	Static	02RT4290TT34	2,304	2,749	2,688
	42 x 96 *	Static	02RT4296TT34	2,304	2,749	2,703
	48 x 84	Static	02RT4884TT34	2,460	2,967	2,853
	48 x 90 *	Static	02RT4890TT34	2,460	2,967	2,868
	48 x 96 *	Static	02RT4896TT34	2,460	2,967	2,882

Race-track with 3 TT-bases	Top Size	Base	Model Number	3P	3K	3W
  <div style="display: flex; align-items: center; margin-top: 10px;"> ⊗ → <div style="display: flex; gap: 5px;"> <div style="border: 1px solid black; border-radius: 50%; padding: 2px;">LC</div> <div style="border: 1px solid black; border-radius: 50%; padding: 2px;">CH</div> <div style="border: 1px solid black; border-radius: 50%; padding: 2px;">SH</div> </div> </div> <p>3 bases: N/A +171 quote</p>	42 x 120	Static	02RT42120TT34(3)-TJ	\$ 2,953	\$ 3,656	\$ 3,473
	42 x 144	Static	02RT42144TT34(3)-TJ	3,264	4,092	3,873
	48 x 120	Static	02RT48120TT36(3)-TJ	2,970	3,681	3,501
	48 x 144	Static	02RT48144TT36(3)-TJ	3,284	4,121	3,904

* \$200 NET surcharge per order for oversized pallet

For Fundamental series table options, please reference pages 54-55.

Top Size	Base	Model Number	3P	3K	3W	Elliptical with T-bases
30 x 54	Static	02EL3054T22	\$ 972	\$ 1,153	\$ 1,175	
30 x 60	Static	02EL3060T22	1,019	1,220	1,239	
36 x 60	Static	02EL3660T26	1,124	1,366	1,365	
36 x 72	Static	02EL3672T26	1,240	1,527	1,515	
36 x 84	Static	02EL3684T26	1,485	1,821	1,795	
36 x 90 *	Static	02EL3690T26	1,601	1,983	1,933	
36 x 96 *	Static	02EL3696T26	1,601	1,983	1,945	

Top Size	Base	Model Number	3P	3K	3W	Elliptical with TT-bases
42 x 72	Static	02EL4272TT26	\$ 1,568	\$ 1,903	\$ 1,866	
42 x 84	Static	02EL4284TT26	1,784	2,172	2,118	
42 x 90 *	Static	02EL4290TT26	1,927	2,373	2,287	
42 x 96 *	Static	02EL4296TT26	1,927	2,373	2,298	
48 x 72	Static	02EL4872TT30	1,683	2,065	2,004	
48 x 84	Static	02EL4884TT30	2,081	2,588	2,456	
48 x 90 *	Static	02EL4890TT30	2,081	2,588	2,468	
48 x 96 *	Static	02EL4896TT30	2,081	2,588	2,479	



Top Size	Base	Model Number	3P	3K	3W	Elliptical with 3 TT-bases
42 x 120	Static	02EL42120TT34(3)-TJ	\$ 2,953	\$ 3,656	\$ 3,433	
42 x 144	Static	02EL42144TT34(3)-TJ	3,264	4,092	3,821	
48 x 120	Static	02EL48120TT36(3)-TJ	2,970	3,681	3,464	
48 x 144	Static	02EL48144TT36(3)-TJ	3,284	4,121	3,855	



LC CH SH ← ⊗
 N/A +171 quote 3 bases:



* \$200 NET surcharge per order for oversized pallet

For Fundamental series table options, please reference pages 54-55.

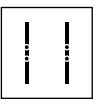

fundamental

Square with X-base	Top Size	Base	Model Number	3P	3K	3W
   <p>Flip Top X</p>	24 x 24	Static	02SQ2424X22	\$ 538	\$ 586	\$ 665
		Flip Top	02SQ2424X22FT	695	743	822
	30 x 30	Static	02SQ3030X26	612	688	775
		Flip Top	02SQ3030X26FT	769	844	932
	36 x 36	Static	02SQ3636X32	720	827	919
		Flip Top	02SQ3636X32FT	877	984	1,076
	42 x 42	Static	02SQ4242X36	824	969	1,062
		Flip Top	02SQ4242X36FT	1,058	1,202	1,295
	48 x 48	Static	02SQ4848X38	952	1,140	1,229



Square with 4-column X-base	Top Size	Base	Model Number	3P	3K	3W
   <p>X: CH SH X.4: N/A +286</p>	54 x 54	Static	02SQ5454X36.4	\$ 1,363	\$ 1,599	\$ 1,681
	60 x 60	Static	02SQ6060X42.4	1,631	1,922	1,991

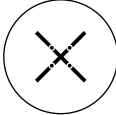

Square with TT-bases	Top Size	Base	Model Number	3P	3K	3W
   <p>Nesting TT</p>	48 x 48	Static	02SQ4848TT34	\$ 1,260	\$ 1,447	\$ 1,537
		Nesting	02SQ4848TT34NE	2,455	2,642	2,731

For Fundamental series table options, please reference pages 54-55.



Top Size	Base	Model Number	3P	3K	3W	Round with X-base
24 x 24	Static	02RD24X22	\$ 578	\$ 643	\$ 685	 
	Flip Top	02RD24X22FT	735	800	842	
30 x 30	Static	02RD30X26	676	777	814	
	Flip Top	02RD30X26FT	833	934	971	
36 x 36	Static	02RD36X30	791	929	961	
	Flip Top	02RD36X30FT	948	1,086	1,118	
42 x 42	Static	02RD42X32	923	1,111	1,128	 Flip Top X
	Flip Top	02RD42X32FT	1,156	1,344	1,361	
48 x 48	Static	02RD48X36	969	1,170	1,200	

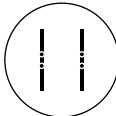

Top Size	Base	Model Number	3P	3K	3W	Round with 4-column X-base
54 x 54	Static	02RD54X32.4	\$ 1,420	\$ 1,703	\$ 1,694	 
60 x 60	Static	02RD60X36.4	1,510	1,804	1,809	

 N/A
  +286
  X.4:

Top Size	Base	Model Number	3P	3K	3W	Round with TT-base
48 x 48	Static	02RD48TT26	\$ 1,233	\$ 1,435	\$ 1,464	 
	Nesting	02RD48TT26NE	2,428	2,630	2,659	
54 x 54	Static	02RD54TT30	1,436	1,720	1,710	
	Nesting	02RD54TT30NE	2,631	2,914	2,905	
60 x 60	Static	02RD60TT34	1,528	1,823	1,828	
	Folding	02RD60TT34FD	2,255	2,549	2,554	
	Nesting	02RD60TT34NE	2,723	3,017	3,022	 Nesting TT

For Fundamental series table options, please reference pages 54-55.

D-shaped with T-bases	Top Size	Base	Model Number	3P	3K	3W
 	24 x 36	Static	02D2436T20	\$ 757	\$ 852	\$ 912
	24 x 48	Static	02D2448T20	836	964	1,028
	24 x 60	Static	02D2460T20	916	1,075	1,145
	24 x 72	Static	02D2472T20	996	1,187	1,261
	24 x 84	Static	02D2484T20	1,160	1,383	1,462
	24 x 90 *	Static	02D2490T20	1,200	1,439	1,520
	24 x 96 *	Static	02D2496T20	1,240	1,495	1,579
	30 x 48	Static	02D3048T26	919	1,079	1,131
	30 x 60	Static	02D3060T26	1,019	1,218	1,269
	30 x 72	Static	02D3072T26	1,119	1,357	1,407
	30 x 84	Static	02D3084T26	1,303	1,582	1,631
	30 x 90 *	Static	02D3090T26	1,353	1,652	1,700
	30 x 96 *	Static	02D3096T26	1,403	1,721	1,769
	36 x 48	Static	02D3648T26	999	1,190	1,230
	36 x 60	Static	02D3660T26	1,119	1,357	1,390
	36 x 72	Static	02D3672T26	1,238	1,525	1,550
	36 x 84	Static	02D3684T26	1,482	1,817	1,835
	36 x 90 *	Static	02D3690T26	1,542	1,901	1,915
	36 x 96 *	Static	02D3696T26	1,602	1,984	1,995



D-shaped with TT-bases	Top Size	Base	Model Number	3P	3K	3W
 	42 x 60	Static	02D4260TT34	\$ 1,896	\$ 2,337	\$ 2,229
	42 x 72	Static	02D4272TT34	1,896	2,337	2,257
	42 x 84	Static	02D4284TT34	1,980	2,422	2,371
	42 x 90 *	Static	02D4290TT34	2,060	2,533	2,472
	42 x 96 *	Static	02D4296TT34	2,138	2,643	2,574
	48 x 60	Static	02D4860TT36	1,907	2,353	2,252
	48 x 72	Static	02D4872TT36	1,907	2,353	2,281
	48 x 84	Static	02D4884TT36	1,992	2,438	2,395
	48 x 90 *	Static	02D4890TT36	2,071	2,549	2,497
	48 x 96 *	Static	02D4896TT36	2,151	2,661	2,599

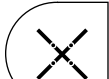

* \$200 NET surcharge per order for oversized pallet

For Fundamental series table options, please reference pages 54-55.

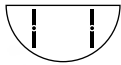
Top Size	Base	Model Number	3P	3K	3W	D-shaped with 4-column X-base
54 x 54	Static	02D5454X36.4	\$ 1,759	\$ 2,153	\$ 2,103	 
60 x 60	Static	02D6060X42.4	1,902	2,300	2,258	

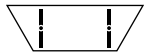

CH	SH	←	⊗
N/A	+286	X.4:	

Top Size	Base	Model Number	3P	3K	3W	Half Round with T-bases
18 x 36	Static	02HR1836T16	\$ 764	\$ 864	\$ 900	  
24 x 48	Static	02HR2448T16	836	965	1,016	
	Nesting	02HR2448T16NE	1,656	1,785	1,836	
30 x 60	Static	02HR3060T20	1,017	1,217	1,252	
	Nesting	02HR3060T22NE	1,837	2,037	2,072	
36 x 72	Static	02HR3672T26	1,237	1,523	1,530	
	Nesting	02HR3672T26NE	2,197	2,483	2,490	

Top Size	Base	Model Number	3P	3K	3W	Trapezoid with T-bases
24 x 48	Static	02TZ2448T18	\$ 825	\$ 950	\$ 1,004	  
24 x 72	Static	02TZ2472T18	1,028	1,233	1,301	
	Nesting	02TZ2472T18NE	1,848	2,053	2,121	
30 x 60	Static	02TZ3060T22	964	1,143	1,194	
	Nesting	02TZ3060T22NE	1,784	1,963	2,014	
36 x 72	Static	02TZ3672T26	1,208	1,483	1,499	
	Nesting	02TZ3672T26NE	2,168	2,443	2,459	

* \$200 NET surcharge per order for oversized pallet

For Fundamental series table options, please reference pages 54-55.

Squircle with X-base		Top Size	Base	Model Number	3P	3K	3W
		24 x 24	Static	02SL24X22	\$ 763	\$ 902	\$ 913
			Flip Top	02SL24X22FT	920	1,059	1,070
30 x 30		Static	02SL30X26	832	995	1,017	
		Flip Top	02SL30X26FT	989	1,152	1,174	
36 x 36		Static	02SL36X32	927	1,117	1,147	
		Flip Top	02SL36X32FT	1,084	1,274	1,304	
 FT Flip Top X	42 x 42	Static	02SL42X36	1,011	1,230	1,267	
		Flip Top	02SL42X36FT	1,245	1,464	1,501	
	48 x 48	Static	02SL48X38	1,119	1,373	1,413	

For Fundamental series table options, please reference pages 54-55.

For Fundamental series table options, please reference pages 54-55.

tablex

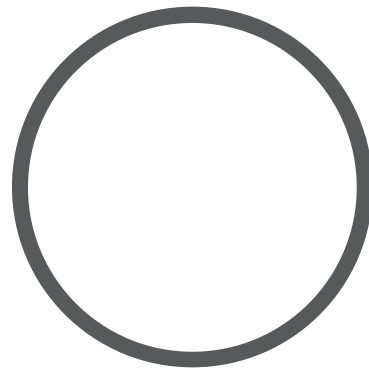

06 stretch
price list

Effective October 1, 2023

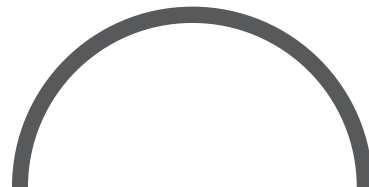



The smoothly curved and sleek look of Stretch makes it a great option for classrooms and training rooms. Its tubular steel construction provides strength and a contemporary design aesthetic.

Stretch Base Styles

stretch



Stretch Options



- LC Locking Casters** can be added to any table for \$111 per set of four.
- CH Chrome Finish** available for \$130 on most models.
- SH Special Height** can be added to any table:
 - + \$72 per column for heights > 29"
 - + \$39 per column for heights < 29"
 Special height tables with tops larger than 36x72" must be custom quoted.
- FD Folding Bases** priced accordingly with standard glides.
- WM Wire Management** Built-in wire management is available for \$139 per column. Specify inside or outside of column.
- FR Footring** is not available on the Stretch series.
- NE Nesting Tables** priced accordingly with locking casters.
- WM/LC Wire Management Leg Covers** snap onto any leg and are \$50 each.
- FT Flip Tops** available on X-based tables and are priced with standard glides.
- PB Powerbox Mounting Plate** is available on X-bases for \$100.
- OS Offset T-bases** available for \$39 per table. Offset is not available on 18"d tables or 30"d nesting tables less than 60" wide.

Stretch Top Shapes



Rectangle
p.72



Boat
p.75



Racetrack
p.76

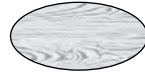

Elliptical
p.77



Square
p.78



Round
p.79



D-shaped
p.80



Half Round
p.82



Trapezoid
p.82



Squircle
p.82

Stretch Top Options

QG Quick-Connect Ganging Brackets can be added to any table for \$45 (includes 4 connectors per table).

RC 3" Radius Corners can be added to any table for \$61.



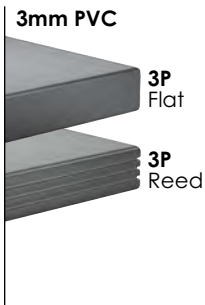

GR Grommets can be added to any table for \$45 each. To see specific locations, see page 227.

Stretch Edge Options

(corresponds with 3 columns of pricing)







stretch

Rectangular with T-bases	Top Size	Base	Model Number	3P	3K	3W
   	20 x 36	Static	06TC2036T18	\$ 753	\$ 826	\$ 906
		Nesting	06TC2036T18NE	1,573	1,646	1,726
	20 x 48	Static	06TC2048T18	812	908	999
		Folding	06TC2048T18FD	1,128	1,223	1,314
		Nesting	06TC2048T18NE	1,632	1,728	1,819
	20 x 60	Static	06TC2060T18	839	946	1,057
		Folding	06TC2060T18FD	1,168	1,274	1,386
		Nesting	06TC2060T18NE	1,659	1,766	1,877
	20 x 72	Static	06TC2072T18	890	1,016	1,142
		Folding	06TC2072T18FD	1,218	1,345	1,470
		Nesting	06TC2072T18NE	1,950	2,077	2,202
	20 x 84	Static	06TC2084T18	1,072	1,238	1,363
		Folding	06TC2084T18FD	1,316	1,482	1,607
		Nesting	06TC2084T18NE	2,048	2,214	2,339
	20 x 90 *	Static	06TC2090T18	1,131	1,320	1,442
		Folding	06TC2090T18FD	1,375	1,564	1,685
		Nesting	06TC2090T18NE	2,107	2,296	2,417
	20 x 96 *	Static	06TC2096T18	1,131	1,320	1,456
Folding		06TC2096T18FD	1,375	1,564	1,700	
Nesting		06TC2096T18NE	2,107	2,296	2,432	
24 x 36	Static	06TC2436T22	753	826	915	
	Nesting	06TC2436T22NE	1,573	1,646	1,735	
24 x 48	Static	06TC2448T22	812	908	1,008	
	Folding	06TC2448T22FD	1,128	1,223	1,324	
	Nesting	06TC2448T22NE	1,632	1,728	1,828	
24 x 60	Static	06TC2460T22	839	946	1,067	
	Folding	06TC2460T22FD	1,168	1,274	1,395	
	Nesting	06TC2460T22NE	1,659	1,766	1,887	
24 x 72	Static	06TC2472T22	890	1,016	1,151	
	Folding	06TC2472T22FD	1,218	1,345	1,480	
	Nesting	06TC2472T22NE	1,950	2,077	2,212	
24 x 84	Static	06TC2484T22	1,072	1,238	1,373	
	Folding	06TC2484T22FD	1,316	1,482	1,616	
	Nesting	06TC2484T22NE	2,048	2,214	2,348	
24 x 90 *	Static	06TC2490T22	1,131	1,320	1,451	
	Folding	06TC2490T22FD	1,375	1,564	1,695	
	Nesting	06TC2490T22NE	2,107	2,296	2,427	
24 x 96 *	Static	06TC2496T22	1,131	1,320	1,466	
	Folding	06TC2496T22FD	1,375	1,564	1,709	
	Nesting	06TC2496T22NE	2,107	2,296	2,441	



stretch

For Stretch series table options, please reference pages 70-71.



Top Size	Base	Model Number	3P	3K	3W	Rectangular with T-bases
30 x 36	Static	06TC3036T26	\$ 800	\$ 890	\$ 981	    <p>Folding T Nesting T</p>
	Nesting	06TC3036T26NE	1,620	1,710	1,801	
30 x 48	Static	06TC3048T26	873	991	1,089	
	Folding	06TC3048T26FD	1,188	1,307	1,405	
	Nesting	06TC3048T26NE	1,693	1,811	1,909	
30 x 60	Static	06TC3060T26	895	1,023	1,143	
	Folding	06TC3060T26FD	1,224	1,352	1,471	
	Nesting	06TC3060T26NE	1,715	1,843	1,963	
30 x 72	Static	06TC3072T26	952	1,102	1,234	
	Folding	06TC3072T26FD	1,281	1,431	1,563	
	Nesting	06TC3072T26NE	2,013	2,163	2,295	
30 x 84	Static	06TC3084T26	1,175	1,381	1,500	
	Folding	06TC3084T26FD	1,419	1,624	1,743	
	Nesting	06TC3084T26NE	2,151	2,356	2,475	
30 x 90 *	Static	06TC3090T26	1,248	1,482	1,594	
	Folding	06TC3090T26FD	1,491	1,726	1,837	
30 x 96 *	Static	06TC3096T26	1,248	1,482	1,608	
	Folding	06TC3096T26FD	1,491	1,726	1,852	
36 x 48	Static	06TC3648T26	930	1,072	1,167	
	Folding	06TC3648T26FD	1,246	1,387	1,482	
	Nesting	06TC3648T26NE	1,890	2,032	2,127	
36 x 60	Static	06TC3660T26	1,017	1,193	1,291	
	Folding	06TC3660T26FD	1,345	1,521	1,619	
	Nesting	06TC3660T26NE	2,051	2,227	2,325	
36 x 72	Static	06TC3672T26	1,071	1,269	1,379	
	Folding	06TC3672T26FD	1,400	1,597	1,708	
	Nesting	06TC3672T26NE	2,132	2,330	2,440	
36 x 84	Static	06TC3684T26	1,314	1,560	1,663	
	Folding	06TC3684T26FD	1,558	1,803	1,907	
36 x 90 *	Static	06TC3690T26	1,400	1,679	1,771	
	Folding	06TC3690T26FD	1,643	1,923	2,015	
36 x 96 *	Static	06TC3696T26	1,400	1,679	1,786	
	Folding	06TC3696T26FD	1,643	1,923	2,029	

* \$200 NET surcharge per order for oversized pallet

For Stretch series table options, please reference pages 70-71.

Rectangular with TT-bases	Top Size	Base	Model Number	3P	3K	3W
   <p>Nesting TT</p>	42 x 60	Static	06TC4260TT32	\$ 1,448	\$ 1,654	\$ 1,744
		Nesting	06TC4260TT32NE	2,605	2,811	2,901
	42 x 72	Static	06TC4272TT32	1,551	1,798	1,886
		Nesting	06TC4272TT32NE	2,708	2,955	3,043
	42 x 84	Static	06TC4284TT32	1,735	2,022	2,108
	42 x 90 *	Static	06TC4290TT32	1,830	2,156	2,228
	42 x 96 *	Static	06TC4296TT32	1,830	2,156	2,242
	48 x 60	Static	06TC4860TT36	1,702	1,920	2,015
		Nesting	06TC4860TT36NE	2,859	3,076	3,172
	48 x 72	Static	06TC4872TT36	1,866	2,149	2,224
		Nesting	06TC4872TT36NE	3,023	3,305	3,381
	48 x 84	Static	06TC4884TT36	1,961	2,248	2,349
48 x 90 *	Static	06TC4890TT36	2,058	2,384	2,470	
48 x 96 *	Static	06TC4896TT36	2,058	2,384	2,485	

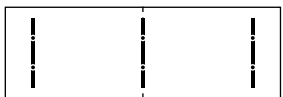
stretch

Rectangular with 3 TT-bases	Top Size	Base	Model Number	3P	3K	3W
   <p>3 bases: N/A +171 quote</p>	42 x 120	Static	06TC42120TT32(3)-TJ	\$ 2,611	\$ 3,094	\$ 3,120
	42 x 144	Static	06TC42144TT32(3)-TJ	2,809	3,371	3,395
	48 x 120	Static	06TC48120TT36(3)-TJ	2,963	3,451	3,488
	48 x 144	Static	06TC48144TT36(3)-TJ	3,163	3,731	3,765

* \$200 NET surcharge per order for oversized pallet

For Stretch series table options, please reference pages 70-71.

Top Size	Base	Model Number	3P	3K	3W	Boat-shaped with T-bases
30 x 42 x 84	Static	06BT3084T26	\$ 1,675	\$ 2,064	\$ 2,031	
30 x 42 x 90 *	Static	06BT3090T26	1,813	2,257	2,197	
30 x 42 x 96 *	Static	06BT3096T26	1,813	2,257	2,211	

Top Size	Base	Model Number	3P	3K	3W	Boat-shaped with TT-bases
36 x 48 x 84	Static	06BT3684TT32	\$ 2,128	\$ 2,572	\$ 2,505	
36 x 48 x 90 *	Static	06BT3690TT32	2,285	2,792	2,693	
36 x 48 x 96 *	Static	06BT3696TT32	2,285	2,792	2,707	





Top Size	Base	Model Number	3P	3K	3W	Boat-shaped with 3 TT-bases
36 x 48 x 120	Static	06BT36120TT36(3)-TJ	\$ 3,521	\$ 4,232	\$ 4,052	
36 x 48 x 144	Static	06BT36144TT36(3)-TJ	3,835	4,671	4,455	



LC CH SH ← ⊗
 N/A +171 quote 3 bases:



stretch

* \$200 NET surcharge per order for oversized pallet

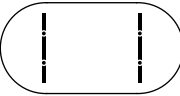
For Stretch series table options, please reference pages 70-71.

Race-track with T-bases	Top Size	Base	Model Number	3P	3K	3W
   	36 x 60	Static	06RT3660T26	\$ 1,295	\$ 1,582	\$ 1,560
		Nesting	06RT3660T26NE	2,255	2,542	2,520
	36 x 72	Static	06RT3672T26	1,295	1,582	1,589
		Folding	06RT3672T26FD	1,623	1,911	1,917
		Nesting	06RT3672T26NE	2,329	2,616	2,622
	36 x 84	Static	06RT3684T26	1,625	1,995	1,968
		Folding	06RT3684T26FD	1,869	2,238	2,212
	36 x 90 *	Static	06RT3690T26	1,760	2,183	2,130
		Folding	06RT3690T26FD	2,003	2,427	2,374
	36 x 96 *	Static	06RT3696T26	1,760	2,183	2,145
		Folding	06RT3696T26FD	2,003	2,427	2,388

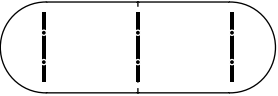
Race-track with TT-bases	Top Size	Base	Model Number	3P	3K	3W
 	42 x 84	Static	06RT4284TT32	\$ 1,988	\$ 2,376	\$ 2,343
	42 x 90 *	Static	06RT4290TT32	2,129	2,573	2,513
	42 x 96 *	Static	06RT4296TT32	2,129	2,573	2,527
	48 x 84	Static	06RT4884TT36	2,511	3,018	2,905
	48 x 90 *	Static	06RT4890TT36	2,511	3,018	2,919
	48 x 96 *	Static	06RT4896TT36	2,511	3,018	2,933

Race-track with 3 TT-bases	Top Size	Base	Model Number	3P	3K	3W
 	42 x 120	Static	06RT42120TT32(3)-TJ	\$ 3,164	\$ 3,868	\$ 3,685
	42 x 144	Static	06RT42144TT32(3)-TJ	3,475	4,303	4,084
	48 x 120	Static	06RT48120TT36(3)-TJ	3,521	4,232	4,052
	48 x 144	Static	06RT48144TT36(3)-TJ	3,835	4,672	4,455

 → **LC** **CH** **SH**
 3 bases: N/A +171 quote

* \$200 NET surcharge per order for oversized pallet

For Stretch series table options, please reference pages 70-71.

stretch

Top Size	Base	Model Number	3P	3K	3W	Elliptical with T-bases
30 x 54	Static	06EL3054T22	\$ 1,027	\$ 1,208	\$ 1,230	
30 x 60	Static	06EL3060T22	1,074	1,275	1,294	
36 x 60	Static	06EL3660T26	1,179	1,421	1,420	
36 x 72	Static	06EL3672T26	1,295	1,582	1,570	
36 x 84	Static	06EL3684T26	1,540	1,876	1,850	
36 x 90 *	Static	06EL3690T26	1,656	2,038	1,988	
36 x 96 *	Static	06EL3696T26	1,656	2,038	2,000	

Top Size	Base	Model Number	3P	3K	3W	Elliptical with TT-bases
42 x 72	Static	06EL4272TT26	\$ 1,772	\$ 2,108	\$ 2,070	
42 x 84	Static	06EL4284TT26	1,988	2,376	2,322	
42 x 90 *	Static	06EL4290TT26	2,131	2,577	2,491	
42 x 96 *	Static	06EL4296TT26	2,131	2,577	2,502	
48 x 72	Static	06EL4872TT32	1,887	2,269	2,209	
48 x 84	Static	06EL4884TT32	2,285	2,792	2,660	
48 x 90 *	Static	06EL4890TT32	2,285	2,792	2,672	
48 x 96 *	Static	06EL4896TT32	2,285	2,792	2,683	



Top Size	Base	Model Number	3P	3K	3W	Elliptical with 3 TT-bases
42 x 120	Static	06EL42120TT26(3)-TJ	\$ 3,164	\$ 3,868	\$ 3,645	
42 x 144	Static	06EL42144TT26(3)-TJ	3,475	4,303	4,032	
48 x 120	Static	06EL48120TT36(3)-TJ	3,521	4,232	4,015	
48 x 144	Static	06EL48144TT36(3)-TJ	3,835	4,672	4,406	

LC CH SH ← ⊗
 N/A +171 quote 3 bases:



* \$200 NET surcharge per order for oversized pallet

For Stretch series table options, please reference pages 70-71.

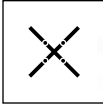

stretch

Square with X-base	Top Size	Base	Model Number	3P	3K	3W
 	24 x 24	Static	06SQ2424X22	\$ 761	\$ 810	\$ 888
		Flip Top	06SQ2424X22FT	918	967	1,045
	30 x 30	Static	06SQ3030X26	829	904	991
		Flip Top	06SQ3030X26FT	986	1,061	1,148
	36 x 36	Static	06SQ3636X32	959	1,066	1,158
		Flip Top	06SQ3636X32FT	1,116	1,223	1,315

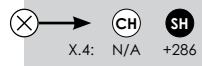

Square with 4-column X-base	Top Size	Base	Model Number	3P	3K	3W
 	42 x 42	Static	06SQ4242X36.4	\$ 1,716	\$ 1,860	\$ 1,953
	48 x 48	Static	06SQ4848X36.4	1,823	2,011	2,100
	54 x 54	Static	06SQ5454X36.4	1,985	2,221	2,303





Square with TT-bases	Top Size	Base	Model Number	3P	3K	3W
 	48 x 48	Static	06SQ4848TT32	\$ 1,361	\$ 1,548	\$ 1,638
		Nesting	06SQ4848TT32NE	2,595	2,783	2,872





For Stretch series table options, please reference pages 70-71.

stretch

Top Size	Base	Model Number	3P	3K	3W	Round with X-base
24 x 24	Static	06RD24X22	\$ 802	\$ 867	\$ 908	  
	Flip Top	06RD24X22FT	959	1,024	1,065	
30 x 30	Static	06RD30X26	893	993	1,031	
	Flip Top	06RD30X26FT	1,049	1,150	1,188	
36 x 36	Static	06RD36X32	1,037	1,176	1,207	
	Flip Top	06RD36X32FT	1,194	1,332	1,364	
42 x 42	Static	06RD42X32	1,162	1,350	1,367	
	Flip Top	06RD42X32FT	1,395	1,583	1,600	

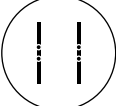

Top Size	Base	Model Number	3P	3K	3W	Round with 4-column X-base
48 x 48	Static	06RD48X36.4	\$ 1,860	\$ 2,062	\$ 2,091	 
54 x 54	Static	06RD54X36.4	2,103	2,386	2,377	
60 x 60	Static	06RD60X36.4	2,132	2,426	2,431	



 N/A
  +286
  X.4:

Top Size	Base	Model Number	3P	3K	3W	Round with TT-base
48 x 48	Static	06RD48TT26	\$ 1,398	\$ 1,600	\$ 1,629	   
	Nesting	06RD48TT26NE	2,632	2,834	2,863	
54 x 54	Static	06RD54TT32	1,641	1,924	1,915	
	Nesting	06RD54TT32NE	2,835	3,118	3,109	
60 x 60	Static	06RD60TT32	1,669	1,963	1,968	
	Folding	06RD60TT32FD	2,395	2,690	2,695	
	Nesting	06RD60TT32NE	2,864	3,158	3,163	

For Stretch series table options, please reference pages 70-71.

stretch

D-shaped with T-bases	Top Size	Base	Model Number	3P	3K	3W
 	24 x 36	Static	06D2436T22	\$ 812	\$ 907	\$ 967
	24 x 48	Static	06D2448T22	891	1,019	1,083
	24 x 60	Static	06D2460T22	971	1,130	1,200
	24 x 72	Static	06D2472T22	1,051	1,242	1,316
	24 x 84	Static	06D2484T22	1,215	1,438	1,517
	24 x 90 *	Static	06D2490T22	1,255	1,494	1,575
	24 x 96 *	Static	06D2496T22	1,295	1,550	1,634
	30 x 48	Static	06D3048T26	975	1,134	1,186
	30 x 60	Static	06D3060T26	1,074	1,273	1,324
	30 x 72	Static	06D3072T26	1,174	1,413	1,462
	30 x 84	Static	06D3084T26	1,358	1,637	1,686
	30 x 90 *	Static	06D3090T26	1,408	1,707	1,755
	30 x 96 *	Static	06D3096T26	1,458	1,776	1,824
	36 x 48	Static	06D3648T26	1,054	1,245	1,285
	36 x 60	Static	06D3660T26	1,174	1,413	1,445
	36 x 72	Static	06D3672T26	1,293	1,580	1,605
	36 x 84	Static	06D3684T26	1,537	1,872	1,890
	36 x 90 *	Static	06D3690T26	1,597	1,956	1,970
	36 x 96 *	Static	06D3696T26	1,657	2,039	2,050

D-shaped with TT-bases	Top Size	Base	Model Number	3P	3K	3W
 	42 x 60	Static	06D4260TT32	\$ 2,036	\$ 2,478	\$ 2,370
		Nesting	06D4260TT32NE	2,036	2,478	2,398
	42 x 72	Static	06D4272TT32	2,121	2,563	2,512
		Nesting	06D4272TT32NE	2,200	2,674	2,613
	42 x 84	Static	06D4284TT32	2,279	2,784	2,714
	42 x 90 *	Static	06D4290TT32	2,274	2,720	2,620
	42 x 96 *	Static	06D4296TT32	2,274	2,720	2,648
	48 x 60	Static	06D4860TT36	2,359	2,805	2,762
		Nesting	06D4860TT36NE	2,439	2,917	2,864
	48 x 72	Static	06D4872TT36	2,518	3,028	2,966
		Nesting	06D4872TT36NE	3,264	3,693	3,650
	48 x 84	Static	06D4884TT36	2,287	2,725	2,713
	48 x 90 *	Static	06D4890TT36	2,366	2,835	2,814
	48 x 96 *	Static	06D4896TT36	2,444	2,945	2,916

* \$200 NET surcharge per order for oversized pallet

For Stretch series table options, please reference pages 70-71.

stretch

Top Size	Base	Model Number	3P	3K	3W	D-shaped with 4-column X-base
----------	------	--------------	----	----	----	-------------------------------

54 x 54	Static	O6D5454X36.4	2,381	2,775	2,725	
---------	--------	--------------	-------	-------	-------	--



Top Size	Base	Model Number	3P	3K	3W	Half Round with T-bases
----------	------	--------------	----	----	----	-------------------------

24 x 48	Static	O6HR2448T18	\$ 895	\$ 1,024	\$ 1,075	
	Nesting	O6HR2448T18NE	1,715	1,844	1,895	
30 x 60	Static	O6HR3060T22	1,072	1,272	1,307	
	Nesting	O6HR3060T22NE	1,892	2,092	2,127	
36 x 72	Static	O6HR3672T26	1,292	1,578	1,585	
	Nesting	O6HR3672T26NE	2,252	2,538	2,545	



Top Size	Base	Model Number	3P	3K	3W	Trapezoid with T-bases
----------	------	--------------	----	----	----	------------------------



24 x 48	Static	O6TZ2448T18	\$ 884	\$ 1,009	\$ 1,063	
24 x 72	Static	O6TZ2472T18	1,087	1,292	1,360	
	Nesting	O6TZ2472T18NE	1,906	2,112	2,180	
30 x 60	Static	O6TZ3060T22	1,019	1,198	1,249	
	Nesting	O6TZ3060T22NE	1,839	2,018	2,069	
36 x 72	Static	O6TZ3672T26	1,263	1,538	1,554	
	Nesting	O6TZ3672T26NE	2,223	2,498	2,514	



* \$200 NET surcharge per order for oversized pallet

For Stretch series table options, please reference pages 70-71.

stretch

Squircle with X-base		Top Size	Base	Model Number	3P	3K	3W
  FT Flip Top X	24 x 24	Static	06SL24X22	\$ 987	\$ 1,126	\$ 1,136	
		Flip Top	06SL24X22FT	1,144	1,283	1,293	
	30 x 30	Static	06SL30X26	1,049	1,212	1,233	
		Flip Top	06SL30X26FT	1,206	1,369	1,390	
	36 x 36	Static	06SL36X32	1,166	1,356	1,386	
		Flip Top	06SL36X32FT	1,323	1,513	1,543	
	42 x 42	Static	06SL42X32	1,239	1,458	1,495	
		Flip Top	06SL42X32FT	1,473	1,692	1,729	

stretch

For Stretch series table options, please reference pages 70-71.

For Stretch series table options, please reference pages 70-71.

tablex

08 elite price list

Effective October 1, 2023





Elite exudes a contemporary style and provides you with our most flexible offering. Its welded base construction delivers lasting functionality without sacrificing beauty.

Elite Base Styles

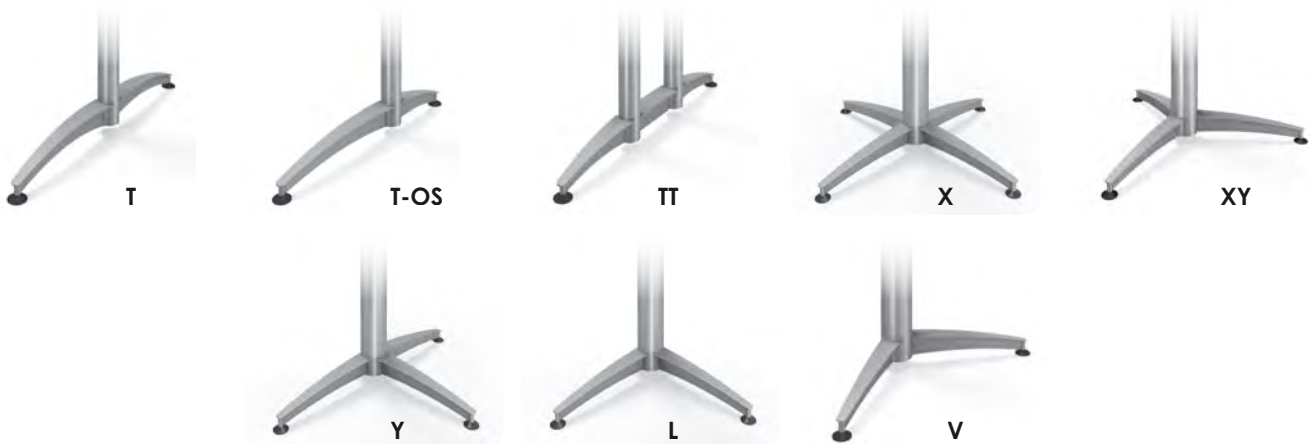

Elite Options

Standard Plastic Glides



Locking Casters



LC Locking Casters
can be added to any table for \$111 per set of four.

FD Folding Bases
priced accordingly with standard glides.

NE Nesting Tables
priced accordingly with locking casters.

FT Flip Tops
available on X-based tables and are priced with standard glides.

CH Chrome Finish
is not available on Elite tables.

WM Wire Management
Built-in wire management is available for \$139 per column. Specify inside or outside of column.

WM LC 2" Wire Management Leg Covers
snap onto any leg and are \$50 each.

WM LC 3" Wire Management Leg Covers
snap onto any leg and are \$79 each. 3" required for X, XY, Y, L base styles.

PB Powerbox Mounting Plate
is available on X-bases for \$100.

FR Footring
is not available on the Elite series.

OS Offset T-bases
available for \$39 per table. Offset is not available on 18"d tables or 30"d nesting tables less than 60" wide.

SH Special Height
can be added to any table:
+ \$72 per column for heights > 29"
+ \$39 per column for heights < 29"
Special height tables with tops larger than 36x72" must be custom quoted.

elite

Elite Top Shapes



Rectangle
p.88



Boat
p.93



Racetrack
p.94



Elliptical
p.95



Square
p.96



Round
p.97



D-shaped
p.98



Half Round
p.100



Trapezoid
p.100



Squircle
p.100

Elite Top Options

QG Quick-Connect Ganging Brackets can be added to any table for \$45 (includes 4 connectors per table).





RC 3" Radius Corners can be added to any table for \$61.

GR Grommets can be added to any table for \$45 each. To see specific locations, see page 227.

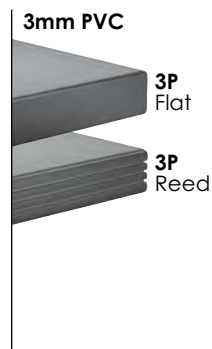
Elite Edge Options





(corresponds with 3 columns of pricing)



Rectangular with T-bases	Top Size	Base	Model Number	3P	3K	3W
   	20 x 36	Static	08TC2036T18	\$ 900	\$ 972	\$1,052
		Nesting	08TC2036T18NE	1,720	1,792	1,872
	20 x 48	Static	08TC2048T18	958	1,054	1,145
		Folding	08TC2048T18FD	1,274	1,369	1,461
		Nesting	08TC2048T18NE	1,778	1,874	1,965
	20 x 60	Static	08TC2060T18	985	1,092	1,204
		Folding	08TC2060T18FD	1,314	1,420	1,532
		Nesting	08TC2060T18NE	1,805	1,912	2,023
	20 x 72	Static	08TC2072T18	1,036	1,163	1,288
		Folding	08TC2072T18FD	1,364	1,491	1,616
		Nesting	08TC2072T18NE	2,096	2,223	2,348
	20 x 84	Static	08TC2084T18	1,219	1,385	1,509
		Folding	08TC2084T18FD	1,462	1,628	1,753
		Nesting	08TC2084T18NE	2,194	2,360	2,485
	20 x 90 *	Static	08TC2090T18	1,277	1,467	1,588
		Folding	08TC2090T18FD	1,521	1,710	1,832
		Nesting	08TC2090T18NE	2,253	2,442	2,564
	20 x 96 *	Static	08TC2096T18	1,277	1,467	1,602
		Folding	08TC2096T18FD	1,521	1,710	1,846
		Nesting	08TC2096T18NE	2,253	2,442	2,578
	24 x 36	Static	08TC2436T22	900	972	1,061
		Nesting	08TC2436T22NE	1,720	1,792	1,881
	24 x 48	Static	08TC2448T22	958	1,054	1,155
		Folding	08TC2448T22FD	1,274	1,369	1,470
Nesting		08TC2448T22NE	1,778	1,874	1,974	
24 x 60	Static	08TC2460T22	985	1,092	1,213	
	Folding	08TC2460T22FD	1,314	1,420	1,542	
	Nesting	08TC2460T22NE	1,805	1,912	2,033	
24 x 72	Static	08TC2472T22	1,036	1,163	1,297	
	Folding	08TC2472T22FD	1,364	1,491	1,626	
	Nesting	08TC2472T22NE	2,096	2,223	2,358	
24 x 84	Static	08TC2484T22	1,219	1,385	1,519	
	Folding	08TC2484T22FD	1,462	1,628	1,762	
	Nesting	08TC2484T22NE	2,194	2,360	2,494	
24 x 90 *	Static	08TC2490T22	1,277	1,467	1,598	
	Folding	08TC2490T22FD	1,521	1,710	1,841	
	Nesting	08TC2490T22NE	2,253	2,442	2,573	
24 x 96 *	Static	08TC2496T22	1,277	1,467	1,612	
	Folding	08TC2496T22FD	1,521	1,710	1,856	
	Nesting	08TC2496T22NE	2,253	2,442	2,588	

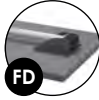

* \$200 NET surcharge per order for oversized pallet

For Elite series table options, please reference pages 86-87.

Top Size	Base	Model Number	3P	3K	3W	Rectangular with T-bases
30 x 36	Static	08TC3036T26	\$ 955	\$ 1,045	\$ 1,136	    <p>Folding T Nesting T</p>
	Nesting	08TC3036T26NE	1,775	1,865	1,956	
30 x 48	Static	08TC3048T26	1,027	1,146	1,244	
	Folding	08TC3048T26FD	1,343	1,462	1,560	
30 x 60	Nesting	08TC3048T26NE	1,847	1,966	2,064	
	Static	08TC3060T26	1,050	1,178	1,298	
	Folding	08TC3060T26FD	1,379	1,506	1,626	
30 x 72	Nesting	08TC3060T26NE	1,870	1,998	2,117	
	Static	08TC3072T26	1,107	1,257	1,389	
	Folding	08TC3072T26FD	1,435	1,586	1,717	
30 x 84	Nesting	08TC3072T26NE	2,167	2,318	2,449	
	Static	08TC3084T26	1,330	1,535	1,654	
	Folding	08TC3084T26FD	1,573	1,779	1,898	
30 x 90 *	Nesting	08TC3084T26NE	2,305	2,511	2,630	
	Static	08TC3090T26	1,402	1,637	1,748	
	Folding	08TC3090T26FD	1,646	1,880	1,992	
30 x 96 *	Static	08TC3096T26	1,402	1,637	1,763	
	Folding	08TC3096T26FD	1,646	1,880	2,006	
36 x 48	Static	08TC3648T26	1,085	1,226	1,321	
	Folding	08TC3648T26FD	1,400	1,542	1,637	
	Nesting	08TC3648T26NE	2,045	2,186	2,281	
36 x 60	Static	08TC3660T26	1,171	1,347	1,445	
	Folding	08TC3660T26FD	1,500	1,676	1,774	
	Nesting	08TC3660T26NE	2,205	2,381	2,479	
36 x 72	Static	08TC3672T26	1,226	1,424	1,534	
	Folding	08TC3672T26FD	1,554	1,752	1,862	
	Nesting	08TC3672T26NE	2,286	2,484	2,594	
36 x 84	Static	08TC3684T26	1,469	1,714	1,818	
	Folding	08TC3684T26FD	1,712	1,958	2,061	
36 x 90 *	Static	08TC3690T26	1,798	2,077	2,170	
	Folding	08TC3690T26FD	1,554	1,834	1,940	
36 x 96 *	Static	08TC3696T26	1,798	2,077	2,184	
	Folding	08TC3696T26FD	1,646	1,907	2,037	



* \$200 NET surcharge per order for oversized pallet



For Elite series table options, please reference pages 86-87.

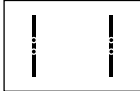

Rectangular with V-bases	Top Size	Base	Model Number	3P	3K	3W
 	24 x 48	Static	08TC2448V22	\$ 1,138	\$ 1,233	\$ 1,334
		Nesting	08TC2448V22NE	1,957	2,053	2,154
	24 x 60	Static	08TC2460V22	1,165	1,271	1,393
		Nesting	08TC2460V22NE	1,985	2,091	2,213
	24 x 72	Static	08TC2472V22	1,215	1,342	1,477
		Nesting	08TC2472V22NE	2,276	2,403	2,537
	24 x 84	Static	08TC2484V22	1,398	1,564	1,698
		Nesting	08TC2484V22NE	2,374	2,540	2,674
	24 x 90 *	Static	08TC2490V22	1,457	1,646	1,777
		Nesting	08TC2490V22NE	2,432	2,622	2,753
	24 x 96 *	Static	08TC2496V22	1,457	1,646	1,791
		Nesting	08TC2496V22NE	2,432	2,622	2,767
	30 x 48	Static	08TC3048V26	1,236	1,355	1,453
		Nesting	08TC3036V26NE	2,056	2,175	2,273
	30 x 60	Static	08TC3060V26	1,259	1,387	1,506
		Nesting	08TC3060V26NE	2,079	2,206	2,326
	30 x 72	Static	08TC3072V26	1,316	1,466	1,597
		Nesting	08TC3072V26NE	2,376	2,526	2,658
	30 x 84	Static	08TC3084V26	1,539	1,744	1,863
		Nesting	08TC3084V26NE	2,514	2,720	2,839
	30 x 90 *	Static	08TC3090V26	1,611	1,846	1,957
	30 x 96 *	Static	08TC3096V26	1,611	1,846	1,972
	36 x 48	Static	08TC3648V32	1,364	1,505	1,601
		Nesting	08TC3648V32NE	2,324	2,465	2,561
	36 x 60	Static	08TC3660V32	1,450	1,626	1,724
		Nesting	08TC3660V32NE	2,484	2,660	2,758
	36 x 72	Static	08TC3672V32	1,505	1,703	1,813
		Nesting	08TC3672V32NE	2,565	2,763	2,874
	36 x 84	Static	08TC3684V32	1,748	1,993	2,097
	36 x 90 *	Static	08TC3690V32	1,834	2,113	2,205
	36 x 96 *	Static	08TC3696V32	1,834	2,113	2,220

* \$200 NET surcharge per order for oversized pallet

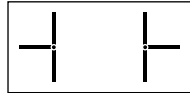
For Elite series table options, please reference pages 86-87.

Top Size	Base	Model Number	3P	3K	3W	Rectangle with TT-bases
42 x 60	Static	08TC4260TT32	\$ 1,714	\$ 1,920	\$ 2,010	   <p>Nesting TT</p>
	Nesting	08TC4260TT32NE	2,871	3,077	3,167	
42 x 72	Static	08TC4272TT32	1,817	2,065	2,152	
	Nesting	08TC4272TT32NE	2,974	3,221	3,309	
42 x 84	Static	08TC4284TT32	2,001	2,288	2,374	
42 x 90 *	Static	08TC4290TT32	2,097	2,422	2,494	
42 x 96 *	Static	08TC4296TT32	2,097	2,422	2,508	
48 x 60	Static	08TC4860TT32	1,742	1,959	2,055	
	Nesting	08TC4860TT32NE	2,899	3,116	3,212	
48 x 72	Static	08TC4872TT32	1,906	2,188	2,264	
	Nesting	08TC4872TT32NE	3,062	3,345	3,420	
48 x 84	Static	08TC4884TT32	2,001	2,288	2,389	
48 x 90 *	Static	08TC4890TT32	2,098	2,424	2,510	
48 x 96 *	Static	08TC4896TT32	2,098	2,424	2,524	

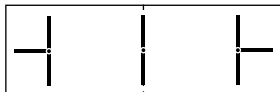
Top Size	Base	Model Number	3P	3K	3W	Rectangle with Y-bases
42 x 60	Static	08TC4260Y36	\$ 1,853	\$ 2,060	\$ 2,149	 
42 x 72	Static	08TC4272Y36	1,956	2,204	2,291	
42 x 84	Static	08TC4284Y36	2,055	2,342	2,429	
42 x 90 *	Static	08TC4290Y36	2,151	2,476	2,548	
42 x 96 *	Static	08TC4296Y36	2,151	2,476	2,563	
48 x 60	Static	08TC4860Y36	1,881	2,099	2,194	
48 x 72	Static	08TC4872Y36	2,045	2,327	2,403	
48 x 84	Static	08TC4884Y36	2,055	2,342	2,443	
48 x 90 *	Static	08TC4890Y36	2,152	2,478	2,564	
48 x 96 *	Static	08TC4896Y36	2,152	2,478	2,579	

Top Size	Base	Model Number	3P	3K	3W	Rectangle with Y & T-bases
42 x 120	Static	08TC42120Y36T36-TJ	\$ 2,959	\$ 3,442	\$ 3,468	 
42 x 144	Static	08TC42144Y36T36-TJ	3,157	3,719	3,743	
48 x 120	Static	08TC48120Y36T36-TJ	2,971	3,459	3,496	
48 x 144	Static	08TC48144Y36T36-TJ	3,171	3,739	3,773	

LC N/A SH quote ← ⊗

3 bases:

* \$200 NET surcharge per order for oversized pallet

For Elite series table options, please reference pages 86-87.

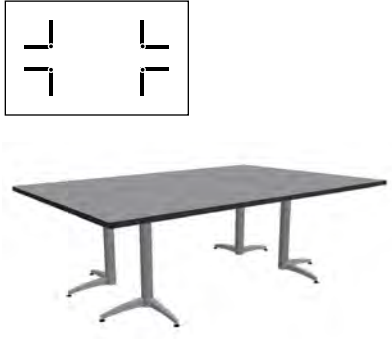
Rectangular with L-bases	Top Size	Base	Model Number	3P	3K	3W
	54 x 60	Static	08TC5460L26	\$ 2,547	\$ 2,812	\$ 2,887
	54 x 72	Static	08TC5472L26	2,680	2,998	3,061
	54 x 84	Static	08TC5484L26	2,812	3,183	3,236
	54 x 90 *	Static	08TC5490L26	2,879	3,276	3,323
	54 x 96 *	Static	08TC5496L26	2,945	3,369	3,410
	60 x 72	Static	08TC6072L26	2,768	3,122	3,173
	60 x 84	Static	08TC6084L26	2,915	3,328	3,363
	60 x 90 *	Static	08TC6090L26	2,989	3,431	3,459
60 x 96 *	Static	08TC6096L26	3,063	3,534	3,554	

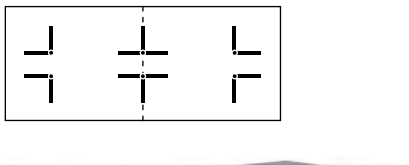

⊗ → LC SH
4 bases: +200 quote

Rectangular with L & Y-bases	Top Size	Base	Model Number	3P	3K	3W
	54 x 120	Static	08TC54120L26Y26-TJ	\$ 4,384	\$ 4,984	\$ 4,951
	54 x 144	Static	08TC54144L26Y26-TJ	4,649	5,355	5,300
	60 x 120	Static	08TC60120L26Y26-TJ	4,509	5,159	5,103
	60 x 144	Static	08TC60144L26Y26-TJ	4,826	5,603	5,509

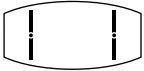

⊗ → LC SH
3 bases: N/A N/A

* \$200 NET surcharge per order for oversized pallet

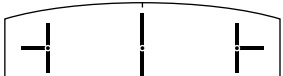

For Elite series table options, please reference pages 86-87.

Top Size	Base	Model Number	3P	3K	3W	Boat-shaped with T-bases
30 x 42 x 84	Static	08BT3084T26	\$ 1,829	\$ 2,219	\$ 2,185	 
30 x 42 x 90 *	Static	08BT3090T26	1,967	2,412	2,351	
30 x 42 x 96 *	Static	08BT3096T26	1,967	2,412	2,366	

Top Size	Base	Model Number	3P	3K	3W	Boat-shaped with Y-bases
36 x 48 x 84	Static	08BT3684Y26	\$ 2,353	\$ 2,797	\$ 2,731	 
36 x 48 x 90 *	Static	08BT3690Y26	2,510	3,017	2,918	
36 x 48 x 96 *	Static	08BT3696Y26	2,510	3,017	2,932	

Top Size	Base	Model Number	3P	3K	3W	Boat-shaped with Y & T-bases
36 x 48 x 120	Static	08BT36120Y26T32-TJ	\$ 3,398	\$ 4,108	\$ 3,928	 
36 x 48 x 144	Static	08BT36144Y26T32-TJ	3,712	4,548	4,331	

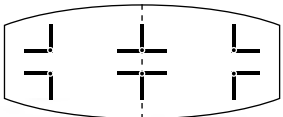
LC SH ← X
N/A quote 3 bases:



Top Size	Base	Model Number	3P	3K	3W	Boat-shaped with L & Y-bases
42 x 54 x 120	Static	08BT42120L26Y26-TJ	\$ 4,854	\$ 5,643	\$ 5,413	 
42 x 54 x 144	Static	08BT42144L26Y26-TJ	5,067	5,940	5,704	
48 x 60 x 120	Static	08BT48120L26Y26-TJ	4,890	5,693	5,460	
48 x 60 x 144	Static	08BT48144L26Y26-TJ	5,108	5,998	5,758	



LC SH ← X
N/A N/A 3 bases:

* \$200 NET surcharge per order for oversized pallet



For Elite series table options, please reference pages 86-87.

Race-track with T-bases	Top Size	Base	Model Number	3P	3K	3W
   	36 x 60	Static	08RT3660T26	\$1,450	\$1,737	\$1,714
		Nesting	08RT3660T26NE	2,410	2,697	2,674
	36 x 72	Static	08RT3672T26	1,450	1,737	1,743
		Folding	08RT3672T26FD	1,778	2,065	2,072
		Nesting	08RT3672T26NE	2,483	2,771	2,777
	36 x 84	Static	08RT3684T26	1,780	2,149	2,123
		Folding	08RT3684T26FD	2,023	2,393	2,366
	36 x 90 *	Static	08RT3690T26	1,914	2,338	2,285
		Folding	08RT3690T26FD	2,158	2,581	2,528
	36 x 96 *	Static	08RT3696T26	1,914	2,338	2,299
		Folding	08RT3696T26FD	2,158	2,581	2,543

Race-track with Y-bases	Top Size	Base	Model Number	3P	3K	3W
 	42 x 84	Static	08RT4284Y32	\$2,275	\$2,663	\$2,631
	42 x 90 *	Static	08RT4290Y32	2,416	2,861	2,800
	42 x 96 *	Static	08RT4296Y32	2,416	2,861	2,815
	48 x 84	Static	08RT4884Y36	2,605	3,112	2,999
	48 x 90 *	Static	08RT4890Y36	2,605	3,112	3,013
	48 x 96 *	Static	08RT4896Y36	2,605	3,112	3,027

Race-track with Y & T-bases	Top Size	Base	Model Number	3P	3K	3W
 	42 x 120	Static	08RT42120Y32T32-TJ	\$3,065	\$3,768	\$3,585
	42 x 144	Static	08RT42144Y32T32-TJ	3,376	4,204	3,985
	48 x 120	Static	08RT48120Y36T36-TJ	3,115	3,826	3,646
	48 x 144	Static	08RT48144Y36T36-TJ	3,430	4,266	4,049

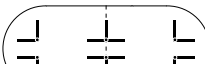
 →  
 3 bases: N/A quote

Race-track with L & Y-bases	Top Size	Base	Model Number	3P	3K	3W
 	54 x 120	Static	08RT54120L26Y26-TJ	\$4,052	\$4,919	\$4,630
	54 x 144	Static	08RT54144L26Y26-TJ	4,371	5,365	5,038
	60 x 120	Static	08RT60120L26Y26-TJ	4,052	4,919	4,638
	60 x 144	Static	08RT60144L26Y26-TJ	4,371	5,365	5,046

 →  
 3 bases: N/A N/A

* \$200 NET surcharge per order for oversized pallet

For Elite series table options, please reference pages 86-87.

Top Size	Base	Model Number	3P	3K	3W	Elliptical with T-bases
30 x 54	Static	08EL3054T22	\$ 1,173	\$ 1,354	\$ 1,376	
30 x 60	Static	08EL3060T22	1,221	1,421	1,440	
36 x 60	Static	08EL3660T26	1,334	1,575	1,575	
36 x 72	Static	08EL3672T26	1,450	1,737	1,725	
36 x 84	Static	08EL3684T26	1,695	2,031	2,005	
36 x 90 *	Static	08EL3690T26	1,810	2,192	2,143	
36 x 96 *	Static	08EL3696T26	1,810	2,192	2,154	

Top Size	Base	Model Number	3P	3K	3W	Elliptical with Y-bases
42 x 72	Static	08EL4272Y26	\$ 1,997	\$ 2,333	\$ 2,295	
42 x 84	Static	08EL4284Y26	2,213	2,601	2,547	
42 x 90 *	Static	08EL4290Y26	2,356	2,802	2,716	
42 x 96 *	Static	08EL4296Y26	2,356	2,802	2,727	
48 x 72	Static	08EL4872Y32	2,175	2,556	2,496	
48 x 84	Static	08EL4884Y32	2,573	3,080	2,948	
48 x 90 *	Static	08EL4890Y32	2,573	3,080	2,959	
48 x 96 *	Static	08EL4896Y32	2,573	3,080	2,970	

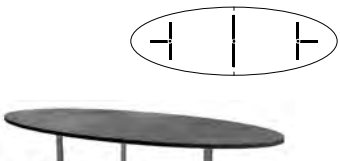

Top Size	Base	Model Number	3P	3K	3W	Elliptical with Y & T-bases
42 x 120	Static	08EL42120Y26T32-TJ	\$ 3,380	\$ 4,084	\$ 3,861	
42 x 144	Static	08EL42144Y26T32-TJ	3,691	4,520	4,248	
48 x 120	Static	08EL48120Y26T32-TJ	3,398	4,109	3,892	
48 x 144	Static	08EL48144Y26T32-TJ	3,712	4,549	4,283	



LC SH ← X
N/A quote 3 bases:

* \$200 NET surcharge per order for oversized pallet

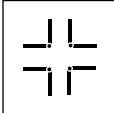

For Elite series table options, please reference pages 86-87.



Square with X-base	Top Size	Base	Model Number	3P	3K	3W
   <p>FT Flip Top X</p>	24 x 24	Static	08SQ2424X22	\$ 729	\$ 777	\$ 856
		Flip Top	08SQ2424X22FT	885	934	1,013
	30 x 30	Static	08SQ3030X26	893	968	1,055
		Flip Top	08SQ3030X26FT	965	1,040	1,128
	36 x 36	Static	08SQ3636X32	918	1,025	1,117
		Flip Top	08SQ3636X32FT	1,075	1,182	1,274
	42 x 42	Static	08SQ4242X36	1,029	1,174	1,267
		Flip Top	08SQ4242X36FT	1,263	1,407	1,500



Square with L-bases	Top Size	Base	Model Number	3P	3K	3W
 	48 x 48	Static	08SQ4848L26	\$2,228	\$2,415	\$2,505
	54 x 54	Static	08SQ5454L26	2,389	2,625	2,707
	60 x 60	Static	08SQ6060L26	2,525	2,815	2,885
	 <p>4 bases: +200 quote</p>					

Square with TT-bases	Top Size	Base	Model Number	3P	3K	3W
   <p>NE Nesting TT</p>	48 x 48	Static	08SQ4848TT32	\$ 1,627	\$ 1,814	\$ 1,904
		Nesting	08SQ4848TT32NE	2,862	3,049	3,138



For Elite series table options, please reference pages 86-87.

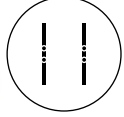

Top Size	Base	Model Number	3P	3K	3W	Round with X-base
24 x 24	Static	08RD24X22	\$ 769	\$ 834	\$ 876	   FT Flip Top X
	Flip Top	08RD24X22FT	926	991	1,032	
30 x 30	Static	08RD30X26	872	973	1,010	
	Flip Top	08RD30X26FT	1,029	1,130	1,167	
36 x 36	Static	08RD36X32	996	1,135	1,166	
	Flip Top	08RD36X32FT	1,153	1,291	1,323	
42 x 42	Static	08RD42X32	1,121	1,309	1,326	
	Flip Top	08RD42X32FT	1,354	1,542	1,559	
48 x 48	Static	08RD48X36	1,173	1,375	1,405	

Top Size	Base	Model Number	3P	3K	3W	Round with L-bases
54 x 54	Static	08RD54L26	\$ 2,098	\$ 2,381	\$ 2,372	  
60 x 60	Static	08RD60L26	2,126	2,421	2,425	

Top Size	Base	Model Number	3P	3K	3W	Round with TT-base
48 x 48	Static	08RD48TT32	\$ 1,664	\$ 1,866	\$ 1,917	   FD Folding TT
	Nesting	08RD48TT32NE	2,898	3,100	3,152	
54 x 54	Static	08RD54TT32	1,907	2,190	2,181	
	Nesting	08RD54TT32NE	3,101	3,385	3,375	
60 x 60	Static	08RD60TT32	1,935	2,230	2,235	
	Folding	08RD60TT32FD	2,662	2,956	2,961	
	Nesting	08RD60TT32NE	3,130	3,424	3,429	



For Elite series table options, please reference pages 86-87.



D-shaped with T-bases	Top Size	Base	Model Number	3P	3K	3W
 	24 x 36	Static	08D2436T22	\$ 958	\$1,053	\$1,113
	24 x 48	Static	08D2448T22	1,037	1,165	1,229
	24 x 60	Static	08D2460T22	1,117	1,276	1,346
	24 x 72	Static	08D2472T22	1,197	1,388	1,462
	24 x 84	Static	08D2484T22	1,361	1,584	1,663
	24 x 90 *	Static	08D2490T22	1,401	1,640	1,722
	24 x 96 *	Static	08D2496T22	1,441	1,696	1,780
	30 x 48	Static	08D3048T26	1,129	1,288	1,340
	30 x 60	Static	08D3060T26	1,229	1,428	1,479
	30 x 72	Static	08D3072T26	1,328	1,567	1,617
	30 x 84	Static	08D3084T26	1,513	1,792	1,840
	30 x 90 *	Static	08D3090T26	1,563	1,861	1,909
	30 x 96 *	Static	08D3096T26	1,612	1,931	1,978
	36 x 48	Static	08D3648T26	1,209	1,400	1,439
	36 x 60	Static	08D3660T26	1,328	1,567	1,599
	36 x 72	Static	08D3672T26	1,448	1,734	1,760
	36 x 84	Static	08D3684T26	1,692	2,027	2,045
	36 x 90 *	Static	08D3690T26	1,752	2,110	2,125
	36 x 96 *	Static	08D3696T26	1,812	2,194	2,205

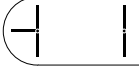

D-shaped with TT-bases	Top Size	Base	Model Number	3P	3K	3W
 	42 x 60	Static	08D4260TT32	\$ 2,303	\$ 2,744	\$ 2,636
	42 x 72	Static	08D4272TT32	2,303	2,744	2,664
	48 x 60	Static	08D4860TT32	2,314	2,760	2,659
	48 x 72	Static	08D4872TT32	2,314	2,760	2,688

* \$200 NET surcharge per order for oversized pallet

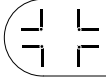
For Elite series table options, please reference pages 86-87.

Top Size	Base	Model Number	3P	3K	3W	D-shaped with Y & T-bases
42 x 60	Static	08D4260Y32T32	\$ 2,171	\$ 2,613	\$ 2,505	 
42 x 72	Static	08D4272Y32T32	2,171	2,613	2,533	
42 x 84	Static	08D4284Y32T32	2,256	2,698	2,647	
42 x 90 *	Static	08D4290Y32T32	2,336	2,809	2,748	
42 x 96 *	Static	08D4296Y32T32	2,414	2,919	2,849	
48 x 60	Static	08D4860Y36T36	2,235	2,681	2,581	
48 x 72	Static	08D4872Y36T36	2,235	2,681	2,610	
48 x 84	Static	08D4884Y36T36	2,320	2,766	2,723	
48 x 90 *	Static	08D4890Y36T36	2,400	2,878	2,825	
48 x 96 *	Static	08D4896Y36T36	2,480	2,989	2,927	

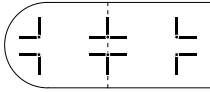

Top Size	Base	Model Number	3P	3K	3W	D-shaped with L-bases
54 x 54	Static	08D5454L26	\$ 2,785	\$ 3,180	\$ 3,115	  <p>LC SH ← ⊗ +200 quote 4 bases:</p>
54 x 60	Static	08D5460L26	2,844	3,262	3,194	
54 x 72	Static	08D5472L26	2,874	3,304	3,256	
54 x 84	Static	08D5484L26	3,168	3,682	3,599	
54 x 90	Static	08D5490L26	3,168	3,682	3,614	
54 x 96 *	Static	08D5496L26	3,168	3,682	3,628	
60 x 60	Static	08D6060L26	2,795	3,193	3,151	
60 x 72	Static	08D6072L26	2,955	3,417	3,355	
60 x 84	Static	08D6084L26	3,258	3,807	3,709	
60 x 90 *	Static	08D6090L26	3,258	3,807	3,724	
60 x 96 *	Static	08D6096L26	3,258	3,807	3,738	



Top Size	Base	Model Number	3P	3K	3W	D-shaped with L & Y-bases
54 x 120	Static	08D54120L26Y26-TJ	\$ 5,006	\$ 5,855	\$ 5,607	  <p>LC SH ← ⊗ N/A N/A 3 bases:</p>
54 x 144	Static	08D54144L26Y26-TJ	5,215	6,148	5,895	
60 x 120	Static	08D60120L26Y26-TJ	5,041	5,904	5,657	
60 x 144	Static	08D60144L26Y26-TJ	5,256	6,205	5,951	

* \$200 NET surcharge per order for oversized pallet

For Elite series table options, please reference pages 86-87.

Half Round with T-bases	Top Size	Base	Model Number	3P	3K	3W
 	24 x 48	Static	08HR2448T18	\$ 1,041	\$ 1,170	\$ 1,221
		Nesting	08HR2448T18NE	1,861	1,990	2,041
	30 x 60	Static	08HR3060T22	1,218	1,418	1,453
		Nesting	08HR3060T22NE	2,038	2,238	2,273
	36 x 72	Static	08HR3672T26	1,446	1,732	1,739
		Nesting	08HR3672T26NE	2,394	2,680	2,688

Trapezoid with T-bases	Top Size	Base	Model Number	3P	3K	3W
 	24 x 48	Static	08TZ2448T18	\$ 1,030	\$ 1,155	\$ 1,209
	24 x 72	Static	08TZ2472T18	1,233	1,438	1,506
		Nesting	08TZ2472T18NE	2,053	2,258	2,326
	30 x 60	Static	08TZ3060T22	1,166	1,344	1,395
		Nesting	08TZ3060T22NE	1,986	2,164	2,215
	36 x 72	Static	08TZ3672T26	1,418	1,693	1,708
	Nesting	08TZ3672T26NE	2,378	2,653	2,668	

Sqircle with X-base	Top Size	Base	Model Number	3P	3K	3W
 	24 x 24	Static	08SL24X22	\$ 954	\$ 1,093	\$ 1,104
		Flip Top	08SL24X22FT	1,111	1,250	1,261
	30 x 30	Static	08SL30X26	1,028	1,191	1,213
		Flip Top	08SL30X26FT	1,185	1,348	1,369
	36 x 36	Static	08SL36X32	1,125	1,315	1,345
		Flip Top	08SL36X32FT	1,282	1,472	1,502
42 x 42	Static	08SL42X36	1,216	1,435	1,472	
	Flip Top	08SL42X36FT	1,450	1,669	1,706	

For Elite series table options, please reference pages 86-87.

For Elite series table options, please reference pages 86-87.

table



09 revel

price list

Effective October 1, 2023





The elegant look and design of our Revel series injects a bit of refinement into a workspace or classroom. Two-tone for a distinctive look. With Revel, you can create additional interest and tie in your brand by selecting a different powder coat finish for the column and main bar. 32 standard finishes available!

Revel Base Style

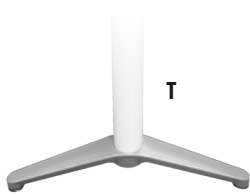

Revel Edge Options

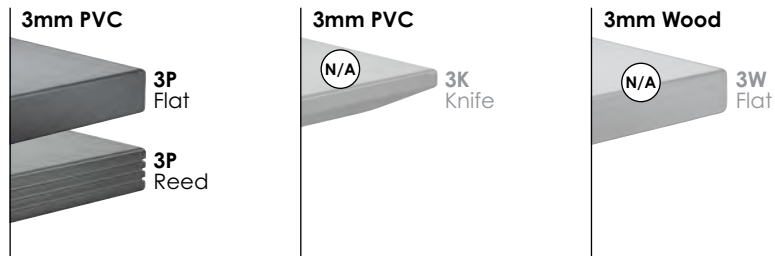

Revel Top Options

QG Quick-Connect Ganging Brackets can be added to any table for \$45 (includes 4 connectors per table).

RC 3" Radius Corners can be added to any table for \$61.

GR Grommets can be added to any table for \$45 each. To see specific locations, see page 227.

Revel Options

Standard
Plastic
Glides



Locking
Casters



LC **Locking Casters**
can be added to any
table for \$111 per set
of four.

NE **Nesting Tables**
priced accordingly with
locking casters.

CH **Chrome Finish**
is not available on
Revel tables.

WM **Wire Management**
Built-in wire management
is not available on
Revel tables.

**WM
LC** **3" Wire Management
Leg Covers**
snap onto any leg and
are \$79 each.

SH **Special Height**
can be added
to any table:
+ \$72 per column
for heights > 29"
+ \$39 per column
for heights < 29"
Special height tables with
tops larger than 36x72"
must be custom quoted.

Top Size	Base	Model Number	3P	Rectangular Top with Revel Base
24 x 60	Static	09TC2460T22	\$ 929	
	Nesting	09TC2460T22NE	1,749	
24 x 72	Static	09TC2472T22	979	
	Nesting	09TC2472T22NE	2,040	
30 x 60	Static	09TC3060T22	991	
	Nesting	09TC3060T22NE	1,811	
30 x 72	Static	09TC3072T22	1,047	
	Nesting	09TC3072T22NE	2,108	

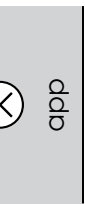

table



17 app

price list

Effective October 1, 2023

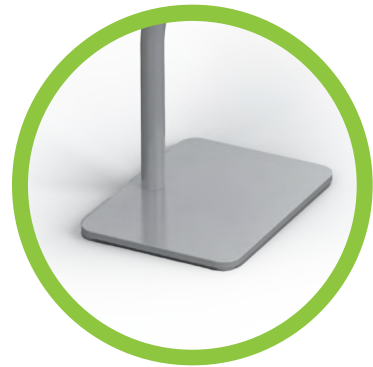

App Styles

Grab your laptop or tablet and pull up the App table. These small, lightweight tables are perfect for casual areas in the workplace or school.

20-lb weight limit.



App Base Styles

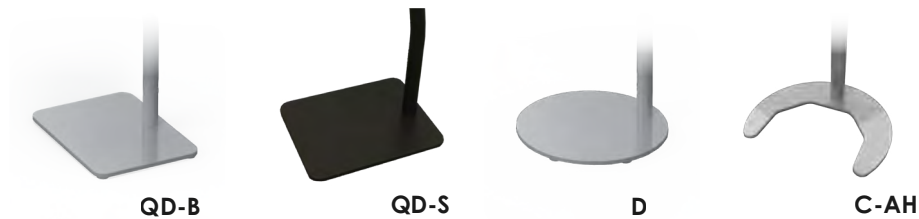

App .75" Edge Options

(corresponds with 2 columns of pricing)

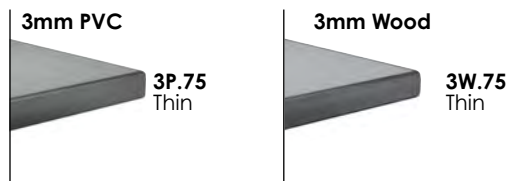

App Top Shapes



Height Adjustability

We offer the ultimate in work mobility with our App height adjustable table. The cutaway, crescent-shaped base allows you to pull up close to any seating option, and the smooth, lever-less height adjustment will make the use of your personal device truly comfortable.



CUP Slide-Out Cup Holder can be added for \$63

Top Size	Base	Model Number	3P.75	3W.75	Soft Rectangle with Rectangular Base
12 x 18	Static	17RC1218QD912-B	\$ 555	\$ 646	

Overall static height: 26"



Top Size	Base	Model Number	3P.75	3W.75	Soft Rectangle with Rectangle Base
12 x 18	Static	17RC1218QD912-S	555	646	

Overall static height: 26"



Top Size	Base	Model Number	3P.75	3W.75	Round with Disc Base
18 x 18	Static	17RD18D12	516	599	

Overall static height: 26"



Top Size	Base	Model Number	3P.75	3W.75	Soft Rectangle with Crescent Base
12 x 18	Static	17RC1218C	592	679	
12 x 18	Adj.	17RC1218C-AH	854	941	

Overall static height: 26"

Overall height adjustable range: 20.75-30.75"



Top Size	Base	Model Number	3P.75	3W.75	Round with Crescent Base
18 x 18	Static	17RD18C	553	636	
18 x 18	Adj.	17RD18C-AH	815	898	

Overall static height: 26"

Overall height adjustable range: 20.75-30.75"



table



33 element
price list

Effective October 1, 2023





Low profile and lightweight aluminum construction makes Element a great mobile solution. Pair it up with your choice of nine different top shapes to create table configurations that are easy to handle.

Element Base Styles



Element Options

Standard
Plastic
Glides



Locking
Casters



Concealed
Casters



LC **Locking Casters**
can be added to any table for \$111 per set of four.

CCG **Concealed Casters**
available on one T-base for \$137 per table. Standard glides on opposite base.

FD **Folding Bases**
priced accordingly with standard glides.

NE **Nesting Tables**
priced accordingly with locking casters.

FT **Flip Tops**
available on X-based tables and are priced with standard glides.

OS **Offset T-bases**
available for \$39 per table. Offset is not available on 18"d tables or 30"d nesting tables less than 60" wide.

CH **Chrome Finish**
is not available on Element tables.

WM **Wire Management**
Built-in wire management is not available on Element tables.

WM LC **Wire Management Leg Covers**
snap onto any round 2" column and are \$50 each. Wire management is not available on oval columns.

SH **Special Height**
can be added to any X-based table:
+ \$72 per column for heights > 29"
- heights < 29" are not available
Special heights are not available on T or TT-bases.

FR **Footring**
is not available on Element series.

PB **Powerbox Mounting Plate**
is not available on Element tables.

Element Height Adjustable Options

Height adjustability only available on Element Solo products. See page 122.

Element Top Shapes



Rectangle
p.114



Racetrack
p.116



Elliptical
p.116



D-shaped
p.117



Square
p.118



Round
p.119



Half Round
p.116



Trapezoid
p.120



Squircle
p.120

Element Top Options

QC Quick-Connect Ganging Brackets can be added to any table for \$45 (includes 4 connectors per table).





RC 3" Radius Corners can be added to any table for \$61.

GR Grommets can be added to any table for \$45 each. To see specific locations, see page 227.

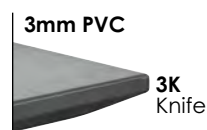
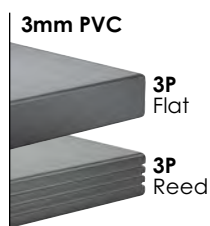



Element Edge Options



(corresponds with 3 columns of pricing)



Rectangular with T-bases	Top Size	Base	Model Number	3P	3K	3W
   	18 x 36	Static	33TC1836T16	\$ 710	\$ 765	\$ 853
		Nesting	33TC1836T18NE	1,530	1,585	1,673
	18 x 48	Static	33TC1848T16	755	828	931
		Folding	33TC1848T16FD	1,070	1,143	1,247
		Nesting	33TC1848T18NE	1,575	1,647	1,751
	18 x 60	Static	33TC1860T16	799	890	1,009
		Folding	33TC1860T16FD	1,128	1,218	1,337
		Nesting	33TC1860T18NE	1,619	1,710	1,829
	18 x 72	Static	33TC1872T16	844	952	1,086
		Folding	33TC1872T16FD	1,172	1,281	1,415
		Nesting	33TC1872T18NE	1,904	2,013	2,147
	20 x 36	Static	33TC2036T18	753	826	906
		Nesting	33TC2036T18NE	1,573	1,646	1,726
	20 x 48	Static	33TC2048T18	812	908	999
		Folding	33TC2048T18FD	1,128	1,223	1,314
		Nesting	33TC2048T18NE	1,632	1,728	1,819
	20 x 60	Static	33TC2060T18	839	946	1,057
		Folding	33TC2060T18FD	1,168	1,274	1,386
Nesting		33TC2060T18NE	1,659	1,766	1,877	
20 x 72	Static	33TC2072T18	890	1,016	1,142	
	Folding	33TC2072T18FD	1,218	1,345	1,470	
	Nesting	33TC2072T18NE	1,950	2,077	2,202	
24 x 36	Static	33TC2436T22	753	826	915	
	Nesting	33TC2436T22NE	1,573	1,646	1,735	
24 x 48	Static	33TC2448T22	812	908	1,008	
	Folding	33TC2448T22FD	1,128	1,223	1,324	
	Nesting	33TC2448T22NE	1,632	1,728	1,828	
24 x 60	Static	33TC2460T22	839	946	1,067	
	Folding	33TC2460T22FD	1,168	1,274	1,395	
	Nesting	33TC2460T22NE	1,659	1,766	1,887	
24 x 72	Static	33TC2472T22	890	1,016	1,151	
	Folding	33TC2472T22FD	1,218	1,345	1,480	
	Nesting	33TC2472T22NE	1,950	2,077	2,212	
30 x 36	Static	33TC3036T26	800	890	981	
	Nesting	33TC3036T26NE	1,620	1,710	1,801	
30 x 48	Static	33TC3048T26	873	991	1,089	
	Folding	33TC3048T26FD	1,188	1,307	1,405	
	Nesting	33TC3048T26NE	1,693	1,811	1,909	
30 x 60	Static	33TC3060T26	895	1,023	1,143	
	Folding	33TC3060T26FD	1,224	1,352	1,471	
	Nesting	33TC3060T26NE	1,715	1,843	1,963	

For Element series table options, please reference pages 112-113.

Top Size	Base	Model Number	3P	3K	3W	Rectangular with T-bases
30 x 72	Static	33TC3072T26	\$ 952	\$ 1,102	\$ 1,234	   FD Folding T  NE Nesting T
	Folding	33TC3072T26FD	1,281	1,431	1,563	
	Nesting	33TC3072T26NE	2,013	2,163	2,295	
36 x 48	Static	33TC3648T26	930	1,072	1,167	
	Folding	33TC3648T26FD	1,246	1,387	1,482	
	Nesting	33TC3648T26NE	1,890	2,032	2,127	
36 x 60	Static	33TC3660T26	1,017	1,193	1,291	
	Folding	33TC3660T26FD	1,345	1,521	1,619	
	Nesting	33TC3660T26NE	2,051	2,227	2,325	
36 x 72	Static	33TC3672T26	1,071	1,269	1,379	
	Folding	33TC3672T26FD	1,400	1,597	1,708	
	Nesting	33TC3672T26NE	2,132	2,330	2,440	

Top Size	Base	Model Number	3P	3K	3W	Rectangular with TT-bases
42 x 60	Static	33TC4260TT30	\$ 1,448	\$ 1,654	\$ 1,744	 
42 x 72	Static	33TC4272TT30	1,551	1,798	1,886	
48 x 60	Static	33TC4860TT36	1,526	1,743	1,839	
48 x 72	Static	33TC4872TT36	1,689	1,972	2,047	

For Element series table options, please reference pages 112-113.

Racetrack with T-bases	Top Size	Base	Model Number	3P	3K	3W
	36 x 60	Static	33RT3660T26	\$ 1,295	\$ 1,582	\$ 1,560
		Nesting	33RT3660T26NE	2,255	2,542	2,520
	36 x 72	Static	33RT3672T26	1,295	1,582	1,589
		Folding	33RT3672T26FD	1,623	1,911	1,917
		Nesting	33RT3672T26NE	2,329	2,616	2,622

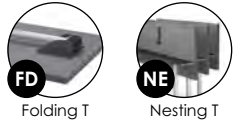



Elliptical with T-bases	Top Size	Base	Model Number	3P	3K	3W
	30 x 54	Static	33EL3054T22	\$ 1,027	\$ 1,208	\$ 1,230
	30 x 60	Static	33EL3060T22	1,074	1,275	1,294
	36 x 60	Static	33EL3660T26	1,179	1,421	1,420
	36 x 72	Static	33EL3672T26	1,295	1,582	1,570



Top Size	Base	Model Number	3P	3K	3W	D-shaped with T-bases
24 x 36	Static	33D2436T22	\$ 812	\$ 907	\$ 967	
24 x 48	Static	33D2448T22	891	1,019	1,083	
24 x 60	Static	33D2460T22	971	1,130	1,200	
24 x 72	Static	33D2472T22	1,051	1,242	1,316	
30 x 48	Static	33D3048T26	975	1,134	1,186	
30 x 60	Static	33D3060T26	1,074	1,273	1,324	
30 x 72	Static	33D3072T26	1,174	1,413	1,462	
36 x 48	Static	33D3648T26	1,054	1,245	1,285	
36 x 60	Static	33D3660T26	1,174	1,413	1,445	
36 x 72	Static	33D3672T26	1,293	1,580	1,605	



Top Size	Base	Model Number	3P	3K	3W	D-shaped with TT-bases
42 x 60	Static	33D4260TT30	\$ 2,036	\$ 2,478	\$ 2,370	
42 x 72	Static	33D4272TT30	2,036	2,478	2,398	
48 x 60	Static	33D4860TT36	2,097	2,543	2,443	
48 x 72	Static	33D4872TT36	2,097	2,543	2,472	

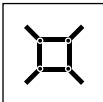

Top Size	Base	Model Number	3P	3K	3W	D-shaped with 4-column X-base
54 x 54	Static	33D5454X36.4	\$ 2,424	\$ 2,818	\$ 2,753	
60 x 60	Static	33D6060X42.4	2,473	2,871	2,829	

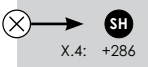
For Element series table options, please reference pages 112-113.



Square with X-base		Top Size	Base	Model Number	3P	3K	3W
   <p>Flip Top X</p>	24 x 24	Static	33SQ2424X22	\$ 748	\$ 797	\$ 876	
		Flip Top	33SQ2424X22FT	905	954	1,033	
	30 x 30	Static	33SQ3030X26	829	905	992	
		Flip Top	33SQ3030X26FT	986	1,061	1,149	
	36 x 36	Static	33SQ3636X32	924	1,031	1,124	
		Flip Top	33SQ3636X32FT	1,081	1,188	1,281	
	42 x 42	Static	33SQ4242X36	1,050	1,194	1,287	
		Flip Top	33SQ4242X36FT	1,283	1,428	1,521	

Square with 4-column X-base		Top Size	Base	Model Number	3P	3K	3W
 	48 x 48	Static	33SQ4848X36.4	\$ 1,866	\$ 2,054	\$ 2,143	
	54 x 54	Static	33SQ5454X36.4	2,028	2,264	2,346	
	60 x 60	Static	33SQ6060X42.4	2,202	2,492	2,562	
	 <p>X.4: +286</p>						

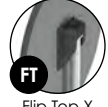

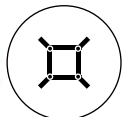
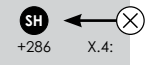
Square with TT-bases		Top Size	Base	Model Number	3P	3K	3W
 	48 x 48	Static	33SQ4848TT26	\$ 1,361	\$ 1,548	\$ 1,638	

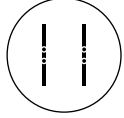

Top Size	Base	Model Number	3P	3K	3W	Round with X-base
24 x 24	Static	33RD24X22	\$ 789	\$ 854	\$ 895	   Flip Top X
	Flip Top	33RD24X22FT	946	1,011	1,052	
30 x 30	Static	33RD30X26	893	994	1,031	
	Flip Top	33RD30X26FT	1,050	1,151	1,188	
36 x 36	Static	33RD36X32	1,003	1,141	1,173	
	Flip Top	33RD36X32FT	1,160	1,298	1,330	
42 x 42	Static	33RD42X32	1,127	1,315	1,332	
	Flip Top	33RD42X32FT	1,361	1,549	1,566	
48 x 48	Static	33RD48X36	1,194	1,396	1,425	

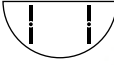

Top Size	Base	Model Number	3P	3K	3W	Round with 4-column X-base
54 x 54	Static	33RD54X36.4	\$ 2,146	\$ 2,429	\$ 2,420	   SH +286 X.4:
60 x 60	Static	33RD60X36.4	2,175	2,469	2,474	

Top Size	Base	Model Number	3P	3K	3W	Round with TT-base
48 x 48	Static	33RD48TT26	\$ 1,398	\$ 1,600	\$ 1,629	   Folding TT
54 x 54	Static	33RD54TT30	1,641	1,924	1,915	
60 x 60	Static	33RD60TT30	1,669	1,963	1,968	
	Folding	33RD60TT30FD	2,395	2,690	2,695	

For Element series table options, please reference pages 112-113.

Half Round with T-bases	Top Size	Base	Model Number	3P	3K	3W
   <p>NE Nesting T</p>	18 x 36	Static	33HR1836T16	\$ 823	\$ 923	\$ 958
	24 x 48	Static	33HR2448T16	895	1,024	1,075
		Nesting	33HR2448T16NE	1,715	1,844	1,895
	30 x 60	Static	33HR3060T22	1,072	1,272	1,307
		Nesting	33HR3060T22NE	1,892	2,092	2,127
	36 x 72	Static	33HR3672T26	1,292	1,578	1,585
		Nesting	33HR3672T26NE	2,252	2,538	2,545

Trapezoid with T-bases	Top Size	Base	Model Number	3P	3K	3W
   <p>NE Nesting T</p>	24 x 48	Static	33TZ2448T18	\$ 884	\$ 1,009	\$ 1,063
	24 x 72	Static	33TZ2472T18	1,087	1,292	1,360
		Nesting	33TZ2472T18NE	1,906	2,112	2,180
	30 x 60	Static	33TZ3060T22	1,019	1,198	1,249
		Nesting	33TZ3060T22NE	1,839	2,018	2,069
	36 x 72	Static	33TZ3672T26	1,263	1,538	1,554
		Nesting	33TZ3672T26NE	2,223	2,498	2,514

Squircle with X-base	Top Size	Base	Model Number	3P	3K	3W
   <p>FT Flip Top X</p>	24 x 24	Static	33SL24X22	\$ 974	\$ 1,113	\$ 1,124
		Flip Top	33SL24X22FT	1,131	1,270	1,281
	30 x 30	Static	33SL30X26	1,049	1,212	1,234
		Flip Top	33SL30X26FT	1,206	1,369	1,391
	36 x 36	Static	33SL36X32	1,132	1,322	1,352
		Flip Top	33SL36X32FT	1,289	1,478	1,509
	42 x 42	Static	33SL42X36	1,237	1,456	1,493
		Flip Top	33SL42X36FT	1,470	1,689	1,726

For Element series table options, please reference pages 112-113.

Solo Tables: Static, Counterbalanced, and/or Flip Top

Element Solo tables are designed with a single user in mind. Perfect for the classroom, these tables come in a variety of configurations that make them incredibly versatile.

Standard Models:



Static

The standard model is a simple, 29" high table with levelers. Specify with locking casters and the overall height remains 29".



Flip Top

A standard 29" high table with a flip top mechanism for easier storage. Specify with locking casters and the overall height remains 29".



Counterbalanced

A height adjustable column takes this top from 26.75-44.25". Specify with locking casters and the height range increases by 2".



Counterbalanced + Flip Top

A height adjustable column takes this top from 26.75-44.25". Includes a flip top mechanism for easier storage. Specify with locking casters and the height range increases by 1.5".

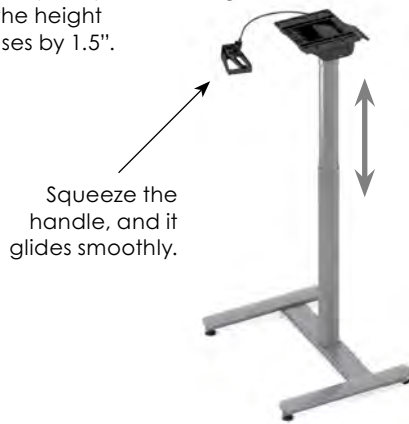

Solo Options

CCG Concealed Caster (non locking) / Glide Combo creates a wheelbarrow effect. Available on Element Solo H-bases for \$137 list.

LC1.5 1.5" Low Profile Locking Casters can be added to any table for \$111 per set of four

MARKER Markerboard Top can be added for \$111 per table (see page 16 for details)

CUP Slide-Out Cup Holder can be added for \$63

FT-GT Flip Top with 15° Tilt Lock Option add \$33 to the FT Flip Top price

PS Acrylic Pencil Stop for tilt lock option can be added for \$32

Element Solo Top Shapes



Rectangle p.124



Trapezoid p.124

Element Solo Base Styles



H

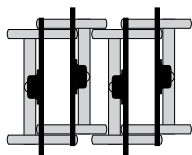





H-base features face-to-face offset nesting

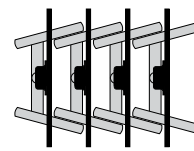





A



A-base features in-line nesting

Top Size	Base	Model Number	3P	3K	3W	Solo Rectangle with H-base
20 x 30	Static	33TC2030H1830	\$ 816	\$ 877	\$ 951	   <p>FT Flip Top X</p>  <p>BL Counter-balanced Ht. Adjustable</p>
	Flip Top	33TC2030H1830FT	1,048	1,109	1,183	
	Count Bal	33TC2030H1830BL	1,441	1,502	1,576	
	Bal + Flip	33TC2030H1830BLFT	1,571	1,632	1,706	
20 x 36	Static	33TC2036H1830	846	918	998	
	Flip Top	33TC2036H1830FT	1,078	1,150	1,230	
	Count Bal	33TC2036H1830BL	1,471	1,543	1,623	
	Bal + Flip	33TC2036H1830BLFT	1,600	1,673	1,752	
24 x 30	Static	33TC2430H1830	816	877	961	
	Flip Top	33TC2430H1830FT	1,048	1,109	1,193	
	Count Bal	33TC2430H1830BL	1,441	1,502	1,586	
	Bal + Flip	33TC2430H1830BLFT	1,571	1,632	1,715	
24 x 36	Static	33TC2436H1830	846	918	1,007	
	Flip Top	33TC2436H1830FT	1,078	1,150	1,239	
	Count Bal	33TC2436H1830BL	1,471	1,543	1,633	
	Bal + Flip	33TC2436H1830BLFT	1,600	1,673	1,762	

Top Size	Base	Model Number	3P	3K	3W	Solo Rectangle with A-base
20 x 30	Static	33TC2030A1830	\$ 816	\$ 877	\$ 951	   <p>FT Flip Top X</p>  <p>BL Counter-balanced Ht. Adjustable</p>
	Flip Top	33TC2030A1830FT	1,048	1,109	1,183	
	Count Bal	33TC2030A1830BL	1,441	1,502	1,576	
	Bal + Flip	33TC2030A1830BLFT	1,571	1,632	1,706	
24 x 30	Static	33TC2430A1830	816	877	961	
	Flip Top	33TC2430A1830FT	1,048	1,109	1,193	
	Count Bal	33TC2430A1830BL	1,441	1,502	1,586	
	Bal + Flip	33TC2430A1830BLFT	1,571	1,632	1,715	

Top Size	Base	Model Number	3P	3K	3W	Solo Trapezoid with A-base
24 x 36	Static	33TZ2436A1830	\$ 976	\$ 1,101	\$ 1,151	   <p>FT Flip Top X</p>  <p>BL Counter-balanced Ht. Adjustable</p>
	Flip Top	33TZ2436A1830FT	1,208	1,333	1,383	
	Count Bal	33TZ2436A1830BL	1,602	1,726	1,776	
	Bal + Flip	33TZ2436A1830BLFT	1,731	1,856	1,906	

tablex

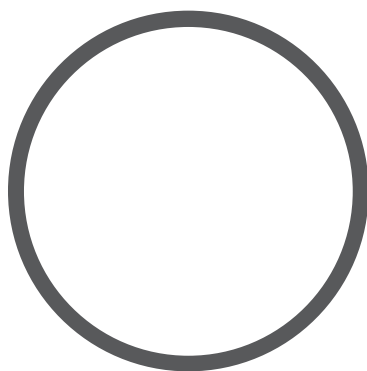

40 justice
price list
Effective October 1, 2023

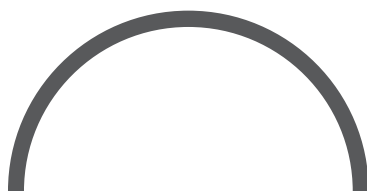

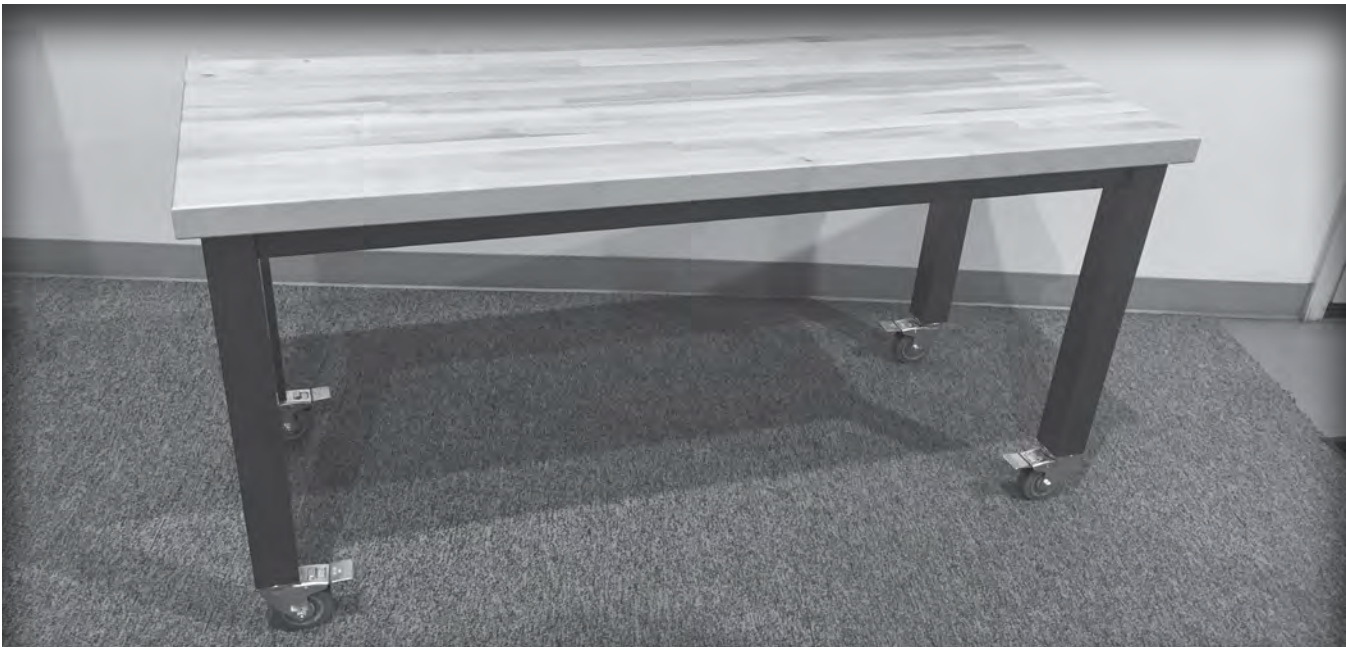

A rigid apron frame and square column legs make Justice a heavy-duty choice when long-lasting durability is a requirement. Its unique design gives it the stability to handle a 500 lb. weight capacity. Justice is available in three different heights and offers mobility when specified with industrial locking casters.

Justice Rigid Frame with Square Column Legs



Justice Options

- ILC Industrial Locking Casters** can be added to any Justice table for \$332 per set of four.
- FD Folding Bases** are not available on Justice tables.
- NE Nesting Tables** are not available in the Justice series.
- FT Flip Tops** are not available on Justice tables.
- WM Wire Management** Built-in wire management is not available on Justice tables.
- WMLC Magnetic Wire Management Leg Covers** Magnetically attaches onto any square leg and are \$71 each.
- CH Chrome Finish** is not available on Justice tables.
- SH Special Heights** of 36" or 42" are available on Justice tables for \$121 per table. Other custom heights are not available on Justice.

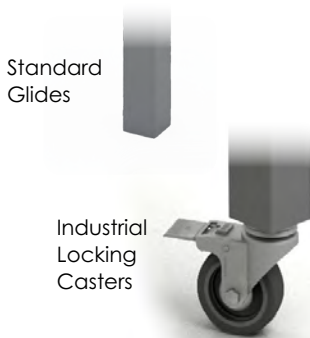

Justice Top Shapes



Rectangle
p.128



Square
p.129



Round
p.129



Squircle
p.129



Boat
p.130



Racetrack
p.130



Elliptical
p.130



D-shaped
p.131

Justice Top Options

GR Grommets
can be added to any table for \$45 each. To see specific locations, See page 227. Locations may be adjusted to avoid Justice frame.

BB Maple Butcher Block
is 1.75" thick with a food-grade clearcoat finish. Available in specific sizes with no grommets and clamp-on power only. Clamp-on power information can be found on page 219.

Call for pricing.

Justice Edge Options

(corresponds with 3 columns of pricing)

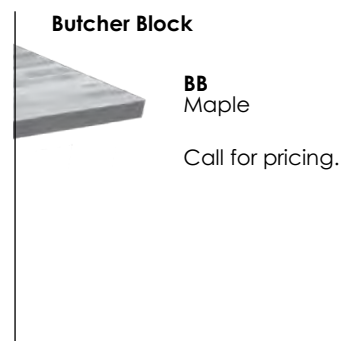
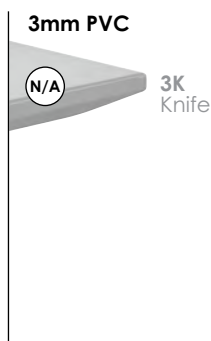
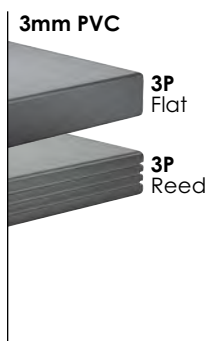

Rectangular with Frame & Columns





Top Size	Base	Model Number	3P	3K	3W
24 x 36	Static	40TC2436FR2234	1,223	NA	1,385
24 x 48	Static	40TC2448FR2246	1,309	NA	1,505
24 x 60	Static	40TC2460FR2258	1,342	NA	1,570
24 x 72	Static	40TC2472FR2270	1,423	NA	1,685
24 x 84	Static	40TC2484FR2270	1,521	NA	1,821
24 x 90 *	Static	40TC2490FR2270	1,579	NA	1,900
24 x 96 *	Static	40TC2496FR2270	1,579	NA	1,914
30 x 36	Static	40TC3036FR2834	1,273	NA	1,453
30 x 48	Static	40TC3048FR2846	1,364	NA	1,581
30 x 60	Static	40TC3060FR2858	1,408	NA	1,655
30 x 72	Static	40TC3072FR2870	1,495	NA	1,777
30 x 84	Static	40TC3084FR2870	1,633	NA	1,957
30 x 90 *	Static	40TC3090FR2870	1,705	NA	2,052
30 x 96 *	Static	40TC3096FR2870	1,705	NA	2,066
36 x 48	Static	40TC3648FR3446	1,431	NA	1,668
36 x 60	Static	40TC3660FR3458	1,545	NA	1,819
36 x 72	Static	40TC3672FR3470	1,626	NA	1,935
36 x 84	Static	40TC3684FR3470	1,785	NA	2,134
36 x 90 *	Static	40TC3690FR3470	1,870	NA	2,242
36 x 96 *	Static	40TC3696FR3470	1,870	NA	2,256
42 x 60	Static	40TC4260FR4058	1,652	NA	1,948
42 x 72	Static	40TC4272FR4070	1,774	NA	2,109
42 x 84	Static	40TC4284FR4070	1,873	NA	2,246
42 x 90 *	Static	40TC4290FR4070	1,968	NA	2,366
42 x 96 *	Static	40TC4296FR4070	1,969	NA	2,380
48 x 60	Static	40TC4860FR4658	1,704	NA	2,017
48 x 72	Static	40TC4872FR4670	1,894	NA	2,253
48 x 84	Static	40TC4884FR4670	1,905	NA	2,293
48 x 90 *	Static	40TC4890FR4670	2,002	NA	2,414
48 x 96 *	Static	40TC4896FR4670	2,002	NA	2,428

* \$200 NET surcharge per order for oversized pallet

For all Justice series table options, please reference pages 126-127.

Top Size	Base	Model Number	3P	3K	3W	Square with Frame & Columns
24 x 24	Static	40SQ2424FR2222	\$ 1,145	NA	\$ 1,272	 
30 x 30	Static	40SQ3030FR2828	1,227	NA	1,389	
36 x 36	Static	40SQ3636FR3434	1,329	NA	1,528	
42 x 42	Static	40SQ4242FR4040	1,446	NA	1,683	
48 x 48	Static	40SQ4848FR4646	1,565	NA	1,841	
54 x 54	Static	40SQ5454FR4646	1,726	NA	2,044	
60 x 60	Static	40SQ6060FR4646	1,862	NA	2,222	

Top Size	Base	Model Number	3P	3K	3W	Round with Frame & Columns
36 x 36	Static	40RD36FR2222	\$ 1,369	NA	\$ 1,539	 
42 x 42	Static	40RD42FR2828	1,509	NA	1,714	
48 x 48	Static	40RD48FR2828	1,544	NA	1,775	
54 x 54	Static	40RD54FR3434	1,809	NA	2,083	
60 x 60	Static	40RD60FR4040	1,862	NA	2,161	

Top Size	Base	Model Number	3P	3K	3W	Squircle with Frame & Columns
30 x 30	Static	40SL30FR2222	\$ 1,431	NA	\$ 1,584	 
36 x 36	Static	40SL36FR2222	1,498	NA	1,680	
42 x 42	Static	40SL42FR2828	1,587	NA	1,799	
48 x 48	Static	40SL48FR3434	1,697	NA	1,941	

For all Justice series table options, please reference pages 126-127.

Boat-shaped with Frame & Columns

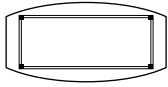

Top Size	Base	Model Number	3P	3K	3W
30 x 42 x 84	Static	40BT3084FR2870	\$ 2,132	NA	\$2,488
30 x 42 x 90 *	Static	40BT3090FR2870	2,270	NA	2,654
30 x 42 x 96 *	Static	40BT3096FR2870	2,270	NA	2,669
36 x 48 x 84	Static	40BT3684FR3470	2,282	NA	2,660
36 x 48 x 90 *	Static	40BT3690FR3470	2,439	NA	2,847
36 x 48 x 96 *	Static	40BT3696FR3470	2,439	NA	2,861

Racetrack with Frame & Columns

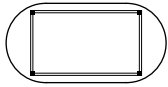

Top Size	Base	Model Number	3P	3K	3W
36 x 72	Static	40RT3672FR2846	\$ 1,786	NA	\$2,080
36 x 84	Static	40RT3684FR2858	2,052	NA	2,395
36 x 90 *	Static	40RT3690FR2858	2,187	NA	2,558
36 x 96 *	Static	40RT3696FR2870	2,217	NA	2,602
42 x 84	Static	40RT4284FR3458	2,115	NA	2,470
42 x 90 *	Static	40RT4290FR3458	2,256	NA	2,640
42 x 96 *	Static	40RT4296FR3470	2,283	NA	2,681
48 x 84	Static	40RT4884FR4058	2,404	NA	2,797
48 x 90 *	Static	40RT4890FR4058	2,404	NA	2,811
48 x 96 *	Static	40RT4896FR4070	2,423	NA	2,845

Elliptical with Frame & Columns

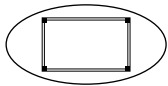

Top Size	Base	Model Number	3P	3K	3W
36 x 72	Static	40EL3672FR2234	\$ 1,761	NA	\$2,036
36 x 84	Static	40EL3684FR2246	1,949	NA	2,258
36 x 90 *	Static	40EL3690FR2246	2,064	NA	2,397
36 x 96 *	Static	40EL3696FR2258	2,070	NA	2,414
42 x 72	Static	40EL4272FR2834	1,928	NA	2,226
42 x 84	Static	40EL4284FR2846	2,078	NA	2,412
42 x 90 *	Static	40EL4290FR2846	2,221	NA	2,581
42 x 96 *	Static	40EL4296FR2858	2,242	NA	2,613
48 x 84	Static	40EL4884FR3446	2,385	NA	2,760
48 x 90 *	Static	40EL4890FR3446	2,385	NA	2,771
48 x 96 *	Static	40EL4896FR3458	2,412	NA	2,810

* \$200 NET surcharge per order for oversized pallet

For all Justice series table options, please reference pages 126-127.

Top Size	Base	Model Number	3P	3K	3W	D-shaped with Frame & Columns
24 x 36	Static	40D2436FR2222	\$ 1,262	NA	\$ 1,417	
24 x 48	Static	40D2448FR2234	1,361	NA	1,553	
24 x 60	Static	40D2460FR2246	1,468	NA	1,696	
24 x 72	Static	40D2472FR2258	1,554	NA	1,819	
24 x 84	Static	40D2484FR2270	1,664	NA	1,966	
24 x 90 *	Static	40D2490FR2270	1,703	NA	2,024	
24 x 96 *	Static	40D2496FR2270	1,743	NA	2,082	
30 x 48	Static	40D3048FR2834	1,447	NA	1,658	
30 x 60	Static	40D3060FR2846	1,566	NA	1,816	
30 x 72	Static	40D3072FR2858	1,686	NA	1,974	
30 x 84	Static	40D3084FR2870	1,816	NA	2,143	
30 x 90 *	Static	40D3090FR2870	1,866	NA	2,212	
30 x 96 *	Static	40D3096FR2870	1,915	NA	2,281	
36 x 48	Static	40D3648FR2834	1,526	NA	1,757	
36 x 60	Static	40D3660FR2846	1,665	NA	1,936	
36 x 72	Static	40D3672FR2858	1,805	NA	2,117	
36 x 84	Static	40D3684FR2870	1,995	NA	2,348	
36 x 90 *	Static	40D3690FR2870	2,055	NA	2,428	
36 x 96 *	Static	40D3696FR2870	2,115	NA	2,508	
42 x 72	Static	40D4272FR3458	2,248	NA	2,610	
42 x 84	Static	40D4284FR3470	2,275	NA	2,666	
42 x 90 *	Static	40D4290FR3470	2,354	NA	2,767	
42 x 96 *	Static	40D4296FR3470	2,433	NA	2,868	
48 x 72	Static	40D4872FR4646	2,251	NA	2,626	
48 x 84	Static	40D4884FR4658	2,275	NA	2,678	
48 x 90 *	Static	40D4890FR4658	2,355	NA	2,780	
48 x 96 *	Static	40D4896FR4670	2,462	NA	2,910	

* \$200 NET surcharge per order for oversized pallet

For all Justice series table options, please reference pages 126-127.

tablex

43 artisan price list

Effective October 1, 2023





Artisan is all about a 'maker-style' aesthetic with the sizes, heights and added versatility you desire. Artisan includes a 500 lb. weight capacity rating for heavy-duty applications. Tables that are 42" or 48" deep will come standard with a Double Rail (.DR) apron that can act as a foot rest.

Artisan Options

Standard
Glides

Industrial
Locking
Casters

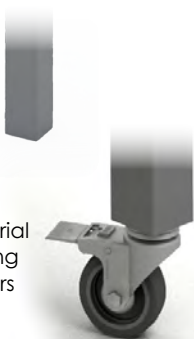

ILC Industrial Locking Casters can be added to any Artisan table for \$332 per set of four.

FD Folding Bases are not available on Artisan tables.

NE Nesting Tables are not available in the Artisan series.

FT Flip Tops are not available on Artisan tables.

WM Wire Management Built-in wire management is not available on Artisan tables.

CH Chrome Finish is not available on Artisan tables.

WMLC Magnetic Wire Management Leg Covers Magnetically attaches onto any square leg and are \$71 each.

Artisan Top Shapes



Rectangle
p.136

Artisan Rigid Frame with Square Column Legs

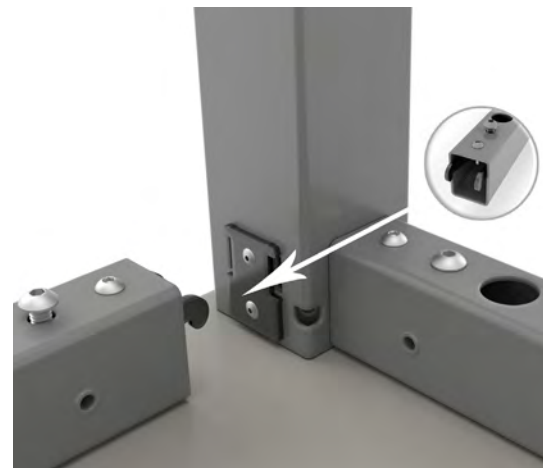

Artisan Top Options

GR **Grommets** can be added to any table for \$45 each. To see specific locations, See page 227. Locations may be adjusted to avoid Artisan frame.

BB **Maple Butcher Block** is 1.75" thick with a food-grade clearcoat finish. Available in specific sizes with no grommets and clamp-on power only. Clamp-on power information can be found on page 219.



Artisan Edge Options

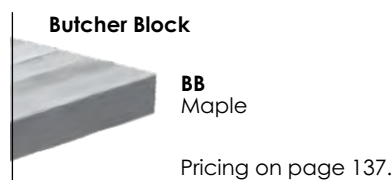
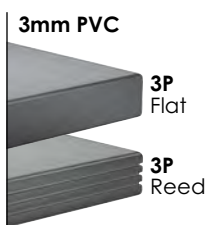

(corresponds with column pricing)





Artisan Series w/ HPL Tops

artisan

Rectangular Static at Standard Height	Top Size	Base	Model Number	3P
 	24 x 60	Single rail	43TC2460FR2157.R-3P	\$ 1,680
	24 x 72	Single rail	43TC2472FR2169.R-3P	1,794
	30 x 60	Single rail	43TC3060FR2757.R-3P	1,778
	30 x 72	Single rail	43TC3072FR2769.R-3P	1,874
	36 x 60	Single rail	43TC3660FR3357.R-3P	1,925
	36 x 72	Single rail	43TC3672FR3369.R-3P	2,015
	42 x 72	Double rail	43TC4272FR3969.DR-3P	2,503
	42 x 96 *	Double rail	43TC4296FR3993.DR-3P	2,974
	48 x 72	Double rail	43TC4872FR4569.DR-3P	2,610
	48 x 96 *	Double rail	43TC4896FR4593.DR-3P	2,992



Rectangular Static at Counter Height	Top Size	Base	Model Number	3P
 	24 x 60	Single rail	43TC2460FR2157.R-3P-SH.36	\$ 1,753
	24 x 72	Single rail	43TC2472FR2169.R-3P-SH.36	1,863
	30 x 60	Single rail	43TC3060FR2757.R-3P-SH.36	1,847
	30 x 72	Single rail	43TC3072FR2769.R-3P-SH.36	1,945
	36 x 60	Single rail	43TC3660FR3357.R-3P-SH.36	1,994
	36 x 72	Single rail	43TC3672FR3369.R-3P-SH.36	2,084
	42 x 72	Double rail	43TC4272FR3969.DR-3P-SH.36	2,575
	42 x 96 *	Double rail	43TC4296FR3993.DR-3P-SH.36	3,048
	48 x 72	Double rail	43TC4872FR4569.DR-3P-SH.36	2,682
	48 x 96 *	Double rail	43TC4896FR4593.DR-3P-SH.36	3,066



Rectangular Static at Bar Height	Top Size	Base	Model Number	3P
 	24 x 60	Single rail	43TC2460FR2157.R-3P-SH.42	\$ 1,813
	24 x 72	Single rail	43TC2472FR2169.R-3P-SH.42	1,926
	30 x 60	Single rail	43TC3060FR2757.R-3P-SH.42	1,910
	30 x 72	Single rail	43TC3072FR2769.R-3P-SH.42	2,005
	36 x 60	Single rail	43TC3660FR3357.R-3P-SH.42	2,057
	36 x 72	Single rail	43TC3672FR3369.R-3P-SH.42	2,149
	42 x 72	Double rail	43TC4272FR3969.DR-3P-SH.42	2,641
	42 x 96 *	Double rail	43TC4296FR3993.DR-3P-SH.42	3,114
	48 x 72	Double rail	43TC4872FR4569.DR-3P-SH.42	2,746
	48 x 96 *	Double rail	43TC4896FR4593.DR-3P-SH.42	3,131



* \$200 NET surcharge per order for oversized pallet

For all Artisan series table options, please reference pages 134-135.

Artisan Series w/ Butcherblock Tops

Top Size	Base	Model Number	BB	Rectangular Static at Standard Height
25 x 60	Single rail	43TC2560FR2157.R-BB	\$ 2,417	 
25 x 72	Single rail	43TC2572FR2169.R-BB	2,681	
30 x 60	Single rail	43TC3060FR2757.R-BB	2,702	
30 x 72	Single rail	43TC3072FR2769.R-BB	2,994	
36 x 60	Single rail	43TC3660FR3357.R-BB	2,987	
36 x 72	Single rail	43TC3672FR3369.R-BB	3,342	
42 x 72	Double rail	43TC4272FR3969.DR-BB	3,983	
42 x 96 *	Double rail	43TC4296FR3993.DR-BB	4,978	
48 x 72	Double rail	43TC4872FR4569.DR-BB	4,977	
48 x 96 *	Double rail	43TC4896FR4593.DR-BB	6,363	

Top Size	Base	Model Number	BB	Rectangular Static at Counter Height
25 x 60	Single rail	43TC2560FR2157.R-BB-SH.36	\$ 2,493	 
25 x 72	Single rail	43TC2572FR2169.R-BB-SH.36	2,753	
30 x 60	Single rail	43TC3060FR2757.R-BB-SH.36	2,774	
30 x 72	Single rail	43TC3072FR2769.R-BB-SH.36	3,068	
36 x 60	Single rail	43TC3660FR3357.R-BB-SH.36	3,059	
36 x 72	Single rail	43TC3672FR3369.R-BB-SH.36	3,414	
42 x 72	Double rail	43TC4272FR3969.DR-BB-SH.36	4,059	
42 x 96 *	Double rail	43TC4296FR3993.DR-BB-SH.36	5,055	
48 x 72	Double rail	43TC4872FR4569.DR-BB-SH.36	5,053	
48 x 96 *	Double rail	43TC4896FR4593.DR-BB-SH.36	6,441	

Top Size	Base	Model Number	BB	Rectangular Static at Bar Height
25 x 60	Single rail	43TC2560FR2157.R-BB-SH.42	\$ 2,556	 
25 x 72	Single rail	43TC2572FR2169.R-BB-SH.42	2,819	
30 x 60	Single rail	43TC3060FR2757.R-BB-SH.42	2,840	
30 x 72	Single rail	43TC3072FR2769.R-BB-SH.42	3,131	
36 x 60	Single rail	43TC3660FR3357.R-BB-SH.42	3,126	
36 x 72	Single rail	43TC3672FR3369.R-BB-SH.42	3,482	
42 x 72	Double rail	43TC4272FR3969.DR-BB-SH.42	4,128	
42 x 96 *	Double rail	43TC4296FR3993.DR-BB-SH.42	5,125	
48 x 72	Double rail	43TC4872FR4569.DR-BB-SH.42	5,121	
48 x 96 *	Double rail	43TC4896FR4593.DR-BB-SH.42	6,509	

* \$200 NET surcharge per order for oversized pallet

For all Artisan series table options, please reference pages 134-135.



44 primary
price list
Effective October 1, 2023

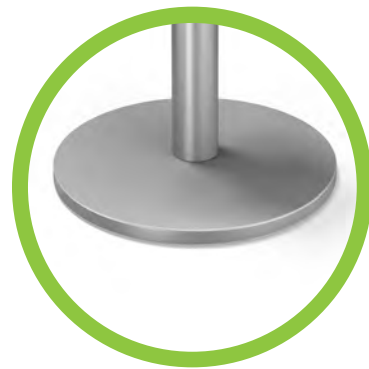



primary

Maximize your foot space with durable traditional column bases. Primary's combination of columns, disc, and drum bases offer alternatives to meet a wide array of applications.

Primary Base Styles

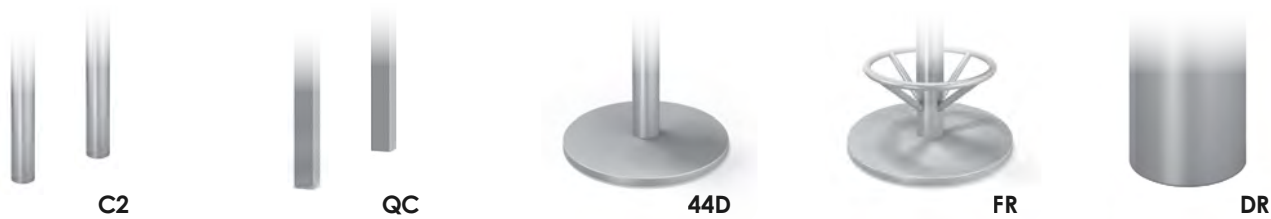

Primary Options

Standard Glides



Locking Casters



COR **Corner Mount Columns** available for \$74 list per table with 2" columns.

LC **Locking Casters** can be added to any table for \$111 per set of four.

QC **Square Columns** are available for an upcharge of \$50 per column.

FD **Folding Bases** are not available on Primary tables.

NE **Nesting Tables** are not available on Primary tables.

FT **Flip Tops** available on some disc-based tables and are priced with standard glides.

CH **Chrome Finish** available on 2" columns only for \$49 per column. Upcharge for 44D disc bases is \$454 per base.

WM **Wire Management** Built-in wire management is available for \$139 per column.

WMLC **Wire Management Leg Covers 2"** snap onto round columns and are \$50 each.

MMLC **Magnetic Wire Management Leg Covers** Magnetically attaches onto any square leg and are \$71 each.

SH **Special Height** can be added to any table:
+ \$72 per column for heights > 29"
+ \$50 per column for heights < 29"
Special height tables with tops larger than 36x72" must be custom quoted.

FR **Footring** available on standing height disc-bases for \$166 per base. Not available in chrome.

PB **Powerbox Mounting Plate** is available on disc bases for \$100.

Primary Height Adjustable Options

- NU Pneumatic** is available on disc bases for \$387 per table. For height option details, see page 19.
- EX Manual Extended Height** is available on 2" columns for \$310 per table. For height option details, see page 19.
- BL Counterbalanced and Short Balanced** are available on disc bases. Available height adjustable finishes can be found on page 9.
- BLS**

Primary Top Shapes

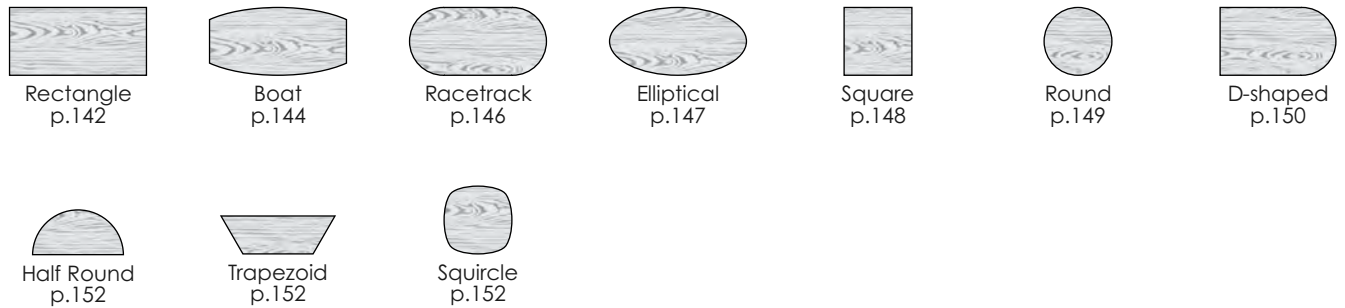

primary

Primary Top Options

- QG Quick-Connect Ganging Brackets** can be added to any table for \$45 (includes 4 connectors per table).
- RC 3" Radius Corners** can be added to any table for \$61.
- GR Grommets** can be added to any table for \$45 each. To see specific locations, see page 227.

Primary Edge Options

(corresponds with 3 columns of pricing)

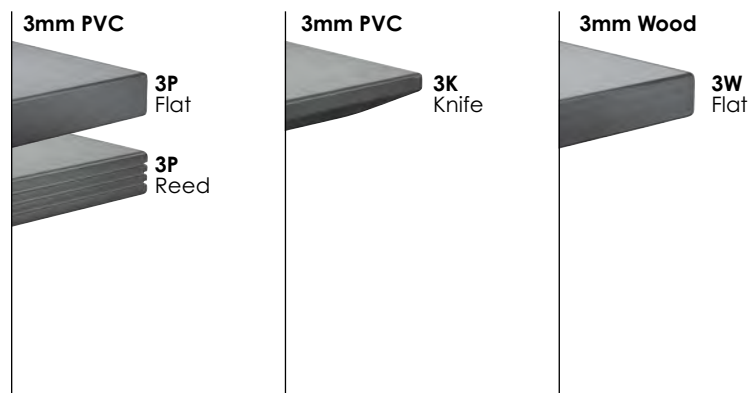

Rectangular with Column Bases | **Top Size** | **Base** | **Model Number** | **3P** | **3K** | **3W**

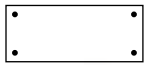

Top Size	Base	Model Number	3P	3K	3W
18 x 36	Static	44TC1836C2	\$ 686	\$ 741	\$ 830
18 x 48	Static	44TC1848C2	731	804	907
18 x 60	Static	44TC1860C2	861	951	1,070
18 x 72	Static	44TC1872C2	905	1,013	1,148
18 x 84	Static	44TC1884C2	950	1,076	1,226
18 x 90 *	Static	44TC1890C2	994	1,138	1,289
18 x 96 *	Static	44TC1896C2	994	1,138	1,303
20 x 36	Static	44TC2036C2	730	802	882
20 x 48	Static	44TC2048C2	788	884	975
20 x 60	Static	44TC2060C2	900	1,007	1,119
20 x 72	Static	44TC2072C2	951	1,078	1,203
20 x 84	Static	44TC2084C2	1,049	1,215	1,339
20 x 90 *	Static	44TC2090C2	1,107	1,297	1,418
20 x 96 *	Static	44TC2096C2	1,107	1,297	1,433
24 x 36	Static	44TC2436C2	730	802	892
24 x 48	Static	44TC2448C2	788	884	985
24 x 60	Static	44TC2460C2	900	1,007	1,128
24 x 72	Static	44TC2472C2	951	1,078	1,213
24 x 84	Static	44TC2484C2	1,049	1,215	1,349
24 x 90 *	Static	44TC2490C2	1,107	1,297	1,428
24 x 96 *	Static	44TC2496C2	1,107	1,297	1,442
30 x 36	Static	44TC3036C2	773	863	954
30 x 48	Static	44TC3048C2	846	964	1,062
30 x 60	Static	44TC3060C2	953	1,081	1,201
30 x 72	Static	44TC3072C2	1,010	1,160	1,292
30 x 84	Static	44TC3084C2	1,148	1,353	1,472
30 x 90 *	Static	44TC3090C2	1,220	1,455	1,567
30 x 96 *	Static	44TC3096C2	1,220	1,455	1,581
36 x 48	Static	44TC3648C2	903	1,044	1,139
36 x 60	Static	44TC3660C2	1,074	1,250	1,348
36 x 72	Static	44TC3672C2	1,129	1,327	1,437
36 x 84	Static	44TC3684C2	1,287	1,532	1,636
36 x 90 *	Static	44TC3690C2	1,372	1,652	1,744
36 x 96 *	Static	44TC3696C2	1,372	1,652	1,758

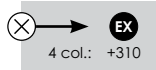

* \$200 NET surcharge per order for oversized pallet

For Primary series table options, please reference pages 140-141.

Top Size	Base	Model Number	3P	3K	3W	Rectangular with 2 Disc Bases
24 x 60	Static	44TC2460D20	\$ 1,799	\$ 1,906	\$ 2,027	
24 x 72	Static	44TC2472D20	1,850	1,977	2,112	
24 x 84	Static	44TC2484D20	2,033	2,199	2,333	
24 x 90 *	Static	44TC2490D20	2,091	2,281	2,412	
24 x 96 *	Static	44TC2496D20	2,091	2,281	2,426	
30 x 60	Static	44TC3060D20	1,852	1,980	2,100	
30 x 72	Static	44TC3072D20	1,909	2,059	2,191	
30 x 84	Static	44TC3084D20	2,132	2,337	2,456	
30 x 90 *	Static	44TC3090D20	2,204	2,439	2,550	
30 x 96 *	Static	44TC3096D20	2,204	2,439	2,565	
36 x 72	Static	44TC3672D24	2,133	2,331	2,441	
36 x 84	Static	44TC3684D24	2,376	2,622	2,725	
36 x 90 *	Static	44TC3690D24	2,462	2,741	2,833	
36 x 96 *	Static	44TC3696D24	2,462	2,741	2,848	
42 x 72	Static	44TC4272D32	2,632	2,880	2,967	
42 x 84	Static	44TC4284D32	2,816	3,103	3,190	
42 x 90 *	Static	44TC4290D32	2,912	3,237	3,309	
42 x 96 *	Static	44TC4296D32	2,912	3,237	3,324	

CH +908
SH +143
← 2 disc bases: ⊗

primary

Top Size	Base	Model Number	3P	3K	3W	Rectangular with Drum Bases
30 x 60	Drum	44TC3060DR18	\$ 4,701	\$ 4,829	\$ 4,948	
30 x 72	Drum	44TC3072DR18	4,758	4,908	5,040	
30 x 84	Drum	44TC3084DR18	4,896	5,101	5,220	
30 x 90 *	Drum	44TC3090DR18	5,053	5,288	5,399	
30 x 96 *	Drum	44TC3096DR18	5,053	5,288	5,414	
36 x 60	Drum	44TC3660DR18	4,822	4,998	5,096	
36 x 72	Drum	44TC3672DR18	4,877	5,074	5,185	
36 x 84	Drum	44TC3684DR18	5,035	5,280	5,384	
36 x 90 *	Drum	44TC3690DR18	5,205	5,485	5,577	
36 x 96 *	Drum	44TC3696DR18	5,205	5,485	5,591	
42 x 72	Drum	44TC4272DR24	5,306	5,553	5,640	
42 x 84	Drum	44TC4284DR24	5,404	5,691	5,778	
42 x 90 *	Drum	44TC4290DR24	5,585	5,910	5,982	
42 x 96 *	Drum	44TC4296DR24	5,585	5,910	5,997	
48 x 72	Drum	44TC4872DR24	5,394	5,677	5,752	
48 x 84	Drum	44TC4884DR24	5,404	5,691	5,792	
48 x 90 *	Drum	44TC4890DR24	5,586	5,912	5,998	
48 x 96 *	Drum	44TC4896DR24	5,586	5,912	6,013	

* \$200 NET surcharge per order for oversized pallet

For Primary series table options, please reference pages 140-141.

Rectangular with 3 Disc Bases	Top Size	Base	Model Number	3P	3K	3W
	42 x 120	Static	44TC42120D32(3)-TJ	\$ 4,233	\$ 4,716	\$ 4,742
	42 x 144	Static	44TC42144D32(3)-TJ	4,431	4,993	5,017



Rectangular with 3 Drum Bases	Top Size	Base	Model Number	3P	3K	3W
	42 x 120	Drum	44TC42120DR24(3)-TJ	\$ 8,243	\$ 8,726	\$ 8,752
	42 x 144	Drum	44TC42144DR24(3)-TJ	8,441	9,003	9,027
	48 x 120	Drum	44TC48120DR24(3)-TJ	8,255	8,743	8,780
	48 x 144	Drum	44TC48144DR24(3)-TJ	8,455	9,023	9,057



Boat-shaped with 2 Disc Bases	Top Size	Base	Model Number	3P	3K	3W
	30 x 42 x 84	Static	44BT3084D24	\$ 2,737	\$ 3,126	\$ 3,093
	30 x 42 x 90 *	Static	44BT3090D24	2,874	3,319	3,259
	30 x 42 x 96 *	Static	44BT3096D24	2,874	3,319	3,273
	36 x 48 x 84	Static	44BT3684D32	3,209	3,653	3,587
	36 x 48 x 90 *	Static	44BT3690D32	3,366	3,873	3,774
	36 x 48 x 96 *	Static	44BT3696D32	3,366	3,873	3,788



Boat-shaped with 2 Drum Bases	Top Size	Base	Model Number	3P	3K	3W
	30 x 42 x 84	Drum	44BT3084DR18	\$ 5,395	\$ 5,785	\$ 5,751
	30 x 42 x 90 *	Drum	44BT3090DR18	5,618	6,063	6,002
	30 x 42 x 96 *	Drum	44BT3096DR18	5,618	6,063	6,017
	36 x 48 x 84	Drum	44BT3684DR24	5,797	6,241	6,175
	36 x 48 x 90 *	Drum	44BT3690DR24	6,039	6,546	6,447
	36 x 48 x 96 *	Drum	44BT3696DR24	6,039	6,546	6,461



* \$200 NET surcharge per order for oversized pallet

For Primary series table options, please reference pages 140-141.

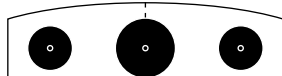
Top Size	Base	Model Number	3P	3K	3W	Boat-shaped with 3 Disc Bases
36 x 48 x 120	Static	44BT36120D243224-TJ	\$ 4,467	\$ 5,178	\$ 4,998	
36 x 48 x 144	Static	44BT36144D243224-TJ	4,781	5,618	5,401	

CH SH ← ⊗
 +1,361 +215 3 disc bases:





Top Size	Base	Model Number	3P	3K	3W	Boat-shaped with 3 Drum Bases
36 x 48 x 120	Drum	44BT36120DR182418-TJ	\$ 8,547	\$ 9,258	\$ 9,078	
36 x 48 x 144	Drum	44BT36144DR182418-TJ	8,718	9,554	9,337	

CH SH ← ⊗
 N/A N/A Drum bases:





primary



For Primary series table options, please reference pages 140-141.

Racetrack with 2 Disc Bases	Top Size	Base	Model Number	3P	3K	3W
 	36 x 72	Static	44RT3672D20	\$2,252	\$2,539	\$2,545
	36 x 84	Static	44RT3684D20	2,582	2,951	2,925
	36 x 90 *	Static	44RT3690D20	2,716	3,140	3,087
	36 x 96 *	Static	44RT3696D20	2,716	3,140	3,101
	42 x 84	Static	44RT4284D24	2,733	3,121	3,089
	42 x 90 *	Static	44RT4290D24	2,874	3,319	3,259
	42 x 96 *	Static	44RT4296D24	2,874	3,319	3,273
	48 x 84	Static	44RT4884D32	3,366	3,873	3,760
	48 x 90 *	Static	44RT4890D32	3,366	3,873	3,774
	48 x 96 *	Static	44RT4896D32	3,366	3,873	3,788

 → 2 disc bases: **CH** +908 **SH** +143

Racetrack with 2 Drum Bases	Top Size	Base	Model Number	3P	3K	3W
 	36 x 72	Drum	44RT3672DR18	\$5,100	\$5,388	\$5,394
	36 x 84	Drum	44RT3684DR18	5,346	5,715	5,689
	36 x 90 *	Drum	44RT3690DR18	5,565	5,989	5,936
	36 x 96 *	Drum	44RT3696DR18	5,565	5,989	5,950
	42 x 84	Drum	44RT4284DR18	5,392	5,780	5,748
	42 x 90 *	Drum	44RT4290DR18	5,618	6,063	6,002
	42 x 96 *	Drum	44RT4296DR18	5,618	6,063	6,017
	48 x 84	Drum	44RT4884DR24	5,954	6,461	6,348
	48 x 90 *	Drum	44RT4890DR24	6,039	6,546	6,447
	48 x 96 *	Drum	44RT4896DR24	6,039	6,546	6,461

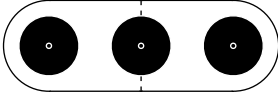
 → Drum bases: **CH** N/A **SH** N/A

Racetrack with 3 Disc Bases	Top Size	Base	Model Number	3P	3K	3W
 	42 x 120	Static	44RT42120D24(3)-TJ	\$4,282	\$4,986	\$4,803
	42 x 144	Static	44RT42144D24(3)-TJ	4,593	5,422	5,203
	48 x 120	Static	44RT48120D32(3)-TJ	4,804	5,515	5,335
	48 x 144	Static	44RT48144D32(3)-TJ	5,118	5,955	5,738

 → 3 disc bases: **CH** +1,361 **SH** +215

* \$200 NET surcharge per order for oversized pallet

For Primary series table options, please reference pages 140-141.

Top Size	Base	Model Number	3P	3K	3W	Race-track with 3 Drum Bases
42 x 120	Drum	44RT42120DR18(3)-TJ	\$ 8,397	\$ 9,101	\$ 8,918	
42 x 144	Drum	44RT42144DR18(3)-TJ	8,709	9,537	9,318	
48 x 120	Drum	44RT48120DR24(3)-TJ	8,813	9,524	9,344	
48 x 144	Drum	44RT48144DR24(3)-TJ	9,127	9,964	9,747	

CH N/A SH N/A ← ⊗ Drum bases:

Top Size	Base	Model Number	3P	3K	3W	Elliptical with 2 Disc Bases
36 x 72	Static	44EL3672D20	\$2,252	\$2,539	\$2,527	
36 x 84	Static	44EL3684D20	2,497	2,833	2,807	
36 x 90 *	Static	44EL3690D20	2,612	2,994	2,945	
36 x 96 *	Static	44EL3696D20	2,612	2,994	2,956	
42 x 72	Static	44EL4272D24	2,517	2,853	2,816	
42 x 84	Static	44EL4284D24	2,733	3,121	3,067	
42 x 90 *	Static	44EL4290D24	2,877	3,322	3,237	
42 x 96 *	Static	44EL4296D24	2,877	3,322	3,248	
48 x 84	Static	44EL4884D32	3,367	3,874	3,742	
48 x 90 *	Static	44EL4890D32	3,367	3,874	3,753	
48 x 96 *	Static	44EL4896D32	3,367	3,874	3,764	

CH +908 SH +143 ← ⊗ 2 disc bases:

Top Size	Base	Model Number	3P	3K	3W	Elliptical with 2 Drum Bases
36 x 72	Drum	44EL3672DR18	\$5,100	\$5,388	\$5,375	
36 x 84	Drum	44EL3684DR18	5,261	5,597	5,571	
36 x 90 *	Drum	44EL3690DR18	5,461	5,843	5,794	
36 x 96 *	Drum	44EL3696DR18	5,461	5,843	5,805	
42 x 72	Drum	44EL4272DR18	5,261	5,597	5,559	
42 x 84	Drum	44EL4284DR18	5,392	5,780	5,726	
42 x 90 *	Drum	44EL4290DR18	5,620	6,066	5,980	
42 x 96 *	Drum	44EL4296DR18	5,620	6,066	5,991	
48 x 84	Drum	44EL4884DR24	5,955	6,462	6,330	
48 x 90 *	Drum	44EL4890DR24	6,040	6,547	6,426	
48 x 96 *	Drum	44EL4896DR24	6,040	6,547	6,437	

CH N/A SH N/A ← ⊗ Drum bases:

* \$200 NET surcharge per order for oversized pallet

For Primary series table options, please reference pages 140-141.

Elliptical with 3 Disc Bases	Top Size	Base	Model Number	3P	3K	3W
	42 x 120	Static	44EL42120D202420-TJ	\$ 4,177	\$ 4,881	\$ 4,658
	42 x 144	Static	44EL42144D202420-TJ	4,488	5,316	5,045
	48 x 120	Static	44EL48120D243224-TJ	4,468	5,179	4,962
	48 x 144	Static	44EL48144D243224-TJ	4,782	5,619	5,352

3 disc bases: +1,361 +215

Elliptical with 3 Drum Bases	Top Size	Base	Model Number	3P	3K	3W
	42 x 120	Drum	44EL42120DR182418-TJ	\$ 8,530	\$ 9,234	\$ 9,011
	42 x 144	Drum	44EL42144DR182418-TJ	8,841	9,670	9,398
	48 x 120	Drum	44EL48120DR182418-TJ	8,548	9,259	9,042
	48 x 144	Drum	44EL48144DR182418-TJ	8,862	9,699	9,433



Drum bases: N/A N/A



Square with Column Bases	Top Size	Base	Model Number	3P	3K	3W
<p> Manual Extended Height </p>	24 x 24	Static	44SQ2424C2	\$ 671	\$ 720	\$ 798
	30 x 30	Static	44SQ3030C2	737	812	899
	36 x 36	Static	44SQ3636C2	816	923	1,016
	42 x 42	Static	44SQ4242C2	910	1,054	1,147
	48 x 48	Static	44SQ4848C2	1,017	1,204	1,294
	54 x 54	Static	44SQ5454C2	1,179	1,415	1,496
	60 x 60	Static	44SQ6060C2	1,399	1,689	1,759



Square with Disc Base	Top Size	Base	Model Number	3P	3K	3W
<p> Short Balanced Ht. Adjustable </p> <p> Counter-balanced Ht. Adjustable </p>	24 x 24	Static	44SQ2424D20	\$ 949	\$ 997	\$ 1,076
		Short Bal	44SQ2424D20BLS	1,539	1,588	1,667
	30 x 30	Static	44SQ3030D24	1,067	1,142	1,229
		Short Bal	44SQ3030D24BLS	1,952	2,027	2,115
	36 x 36	Static	44SQ3636D24	1,146	1,253	1,346
		Short Bal	44SQ3636D24BLS	2,032	2,139	2,231
		Count Bal	44SQ3636D24BL	2,032	2,139	2,231
	42 x 42	Static	44SQ4242D32	1,408	1,552	1,645
		Short Bal	44SQ4242D32BLS	2,287	2,431	2,524
		Count Bal	44SQ4242D32BL	2,287	2,431	2,524

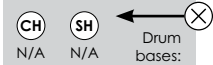

Disc bases: +454 +72

For Primary series table options, please reference pages 140-141.

Top Size	Base	Model Number	3P	3K	3W	Square with Drum Base
30 x 30	Drum	44SQ3030DR18	\$2,439	\$2,514	\$2,601	  
36 x 36	Drum	44SQ3636DR18	2,518	2,625	2,717	
42 x 42	Drum	44SQ4242DR24	2,744	2,889	2,982	
48 x 48	Drum	44SQ4848DR24	2,852	3,039	3,128	
54 x 54	Drum	44SQ5454DR28	3,454	3,690	3,772	
60 x 60	Drum	44SQ6060DR28	3,590	3,880	3,950	

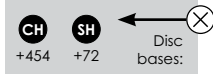
Top Size	Base	Model Number	3P	3K	3W	Round with Column Bases
24 x 24	Static	44RD24C2	\$ 712	\$ 777	\$ 818	  
30 x 30	Static	44RD30C2	801	901	939	
36 x 36	Static	44RD36C2	895	1,033	1,065	
42 x 42	Static	44RD42C2	1,019	1,207	1,224	
48 x 48	Static	44RD48C2	1,054	1,256	1,285	
54 x 54	Static	44RD54C2	1,297	1,580	1,571	
60 x 60	Static	44RD60C2	1,325	1,620	1,625	

Top Size	Base	Model Number	3P	3K	3W	Round with Disc Base
24 x 24	Static	44RD24D20	\$ 989	\$1,054	\$1,096	  
	Short Bal	44RD24D20BLS	1,580	1,645	1,686	
30 x 30	Static	44RD30D20	1,078	1,179	1,216	
	Short Bal	44RD30D20BLS	1,669	1,769	1,807	
36 x 36	Static	44RD36D20	1,172	1,310	1,342	
	Short Bal	44RD36D20BLS	1,763	1,901	1,933	
	Count Bal	44RD36D20BL	1,763	1,901	1,933	
42 x 42	Static	44RD42D24	1,349	1,537	1,554	
	Short Bal	44RD42D24BLS	2,235	2,423	2,440	
	Count Bal	44RD42D24BL	2,235	2,423	2,440	
48 x 48	Static	44RD48D32	1,552	1,754	1,783	
	Short Bal	44RD48D32BLS	2,431	2,633	2,662	
	Count Bal	44RD48D32BL	2,431	2,633	2,662	

Top Size	Base	Model Number	3P	3K	3W	Round with Drum Base
30 x 30	Drum	44RD30DR18	\$2,502	\$2,603	\$2,641	  
36 x 36	Drum	44RD36DR18	2,596	2,735	2,766	
42 x 42	Drum	44RD42DR24	2,854	3,042	3,059	
48 x 48	Drum	44RD48DR24	2,888	3,090	3,119	
54 x 54	Drum	44RD54DR24	3,131	3,415	3,405	
60 x 60	Drum	44RD60DR28	3,601	3,895	3,900	

For Primary series table options, please reference pages 140-141.

primary

D-shaped with Column Bases	Top Size	Base	Model Number	3P	3K	3W
	24 x 36	Static	44D2436C2	\$ 788	\$ 884	\$ 943
	24 x 48	Static	44D2448C2	868	995	1,060
	24 x 60	Static	44D2460C2	947	1,107	1,176
	24 x 72	Static	44D2472C2	1,112	1,303	1,377
	24 x 84	Static	44D2484C2	1,191	1,414	1,494
	24 x 90 *	Static	44D2490C2	1,231	1,470	1,552
	24 x 96 *	Static	44D2496C2	1,271	1,526	1,610
	30 x 48	Static	44D3048C2	947	1,107	1,159
	30 x 60	Static	44D3060C2	1,047	1,246	1,297
	30 x 72	Static	44D3072C2	1,231	1,470	1,520
	30 x 84	Static	44D3084C2	1,331	1,610	1,658
	30 x 90 *	Static	44D3090C2	1,381	1,679	1,727
	30 x 96 *	Static	44D3096C2	1,430	1,749	1,796
	36 x 48	Static	44D3648C2	1,027	1,218	1,257
	36 x 60	Static	44D3660C2	1,146	1,385	1,418
	36 x 72	Static	44D3672C2	1,351	1,637	1,663
	36 x 84	Static	44D3684C2	1,510	1,845	1,863
	36 x 90 *	Static	44D3690C2	1,570	1,928	1,943
36 x 96 *	Static	44D3696C2	1,630	2,012	2,023	





D-shaped with 2 Drum Bases	Top Size	Base	Model Number	3P	3K	3W
	30 x 60	Drum	44D3060DR18	\$4,880	\$5,079	\$5,130
	30 x 72	Drum	44D3072DR18	4,979	5,218	5,268
	30 x 84	Drum	44D3084DR18	5,164	5,443	5,491
	30 x 90 *	Drum	44D3090DR18	5,213	5,512	5,560
	30 x 96 *	Drum	44D3096DR18	5,263	5,582	5,629
	36 x 72	Drum	44D3672DR18	5,099	5,385	5,411
	36 x 84	Drum	44D3684DR18	5,343	5,677	5,696
	36 x 90 *	Drum	44D3690DR18	5,403	5,761	5,776
	36 x 96 *	Drum	44D3696DR18	5,462	5,845	5,856
	42 x 72	Drum	44D4272DR24	5,791	6,232	6,153
	42 x 84	Drum	44D4284DR24	5,876	6,317	6,266
	42 x 90 *	Drum	44D4290DR24	5,955	6,428	6,368
	42 x 96 *	Drum	44D4296DR24	6,034	6,538	6,469
	48 x 72	Drum	44D4872DR24	5,802	6,248	6,176
	48 x 84	Drum	44D4884DR24	5,887	6,333	6,290
	48 x 90 *	Drum	44D4890DR24	5,967	6,445	6,392
	48 x 96 *	Drum	44D4896DR24	6,046	6,556	6,494

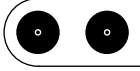

* \$200 NET surcharge per order for oversized pallet

For Primary series table options, please reference pages 140-141.

Top Size	Base	Model Number	3P	3K	3W	D-shaped with 2 Disc Bases
24 x 60	Static	44D2460D20	\$ 1,931	\$ 2,090	\$ 2,160	 
24 x 72	Static	44D2472D20	2,011	2,202	2,276	
24 x 84	Static	44D2484D20	2,175	2,398	2,477	
24 x 90 *	Static	44D2490D20	2,215	2,454	2,536	
24 x 96 *	Static	44D2496D20	2,255	2,510	2,594	
30 x 60	Static	44D3060D20	2,031	2,230	2,281	
30 x 72	Static	44D3072D20	2,130	2,369	2,419	
30 x 84	Static	44D3084D20	2,315	2,594	2,642	
30 x 90 *	Static	44D3090D20	2,365	2,663	2,711	
30 x 96 *	Static	44D3096D20	2,414	2,733	2,780	
36 x 72	Static	44D3672D24	2,355	2,642	2,667	
36 x 84	Static	44D3684D24	2,599	2,934	2,952	
36 x 90 *	Static	44D3690D24	2,659	3,018	3,032	
36 x 96 *	Static	44D3696D24	2,719	3,101	3,112	
42 x 72	Static	44D4272D32	3,118	3,559	3,480	
42 x 84	Static	44D4284D32	3,203	3,644	3,593	
42 x 90 *	Static	44D4290D32	3,282	3,755	3,695	
42 x 96 *	Static	44D4296D32	3,361	3,865	3,796	

CH +908
SH +143
← 2 disc bases: (X)

primary

* \$200 NET surcharge per order for oversized pallet

For Primary series table options, please reference pages 140-141.

Half Round with Column Bases	Top Size	Base	Model Number	3P	3K	3W
	18 x 36	Static	44HR1836C2(3)	\$ 692	\$ 792	\$ 828
	24 x 48	Static	44HR2448C2(3)	764	893	944
	30 x 60	Static	44HR3060C2	1,049	1,248	1,283
	36 x 72	Static	44HR3672C2	1,349	1,635	1,642



EX

Manual
Extended
Height

Trapezoid with Column Bases	Top Size	Base	Model Number	3P	3K	3W
	24 x 48	Static	44TZ2448C2	\$ 646	\$ 771	\$ 825
	24 x 72	Static	44TZ2472C2	848	1,054	1,121
	30 x 60	Static	44TZ3060C2	781	960	1,011
	36 x 72	Static	44TZ3672C2	1,021	1,296	1,312



EX

Manual
Extended
Height

Squircle with Column Bases	Top Size	Base	Model Number	3P	3K	3W
	24 x 24	Static	44SL24C2	\$ 897	\$ 1,036	\$ 1,046
	30 x 30	Static	44SL30C2	957	1,120	1,141
	36 x 36	Static	44SL36C2	1,024	1,213	1,243
	42 x 42	Static	44SL42C2	1,097	1,316	1,353
	48 x 48	Static	44SL48C2	1,184	1,438	1,478



EX

Manual
Extended
Height

For Primary series table options, please reference pages 140-141.

For Primary series table options, please reference pages 140-141.

tablex

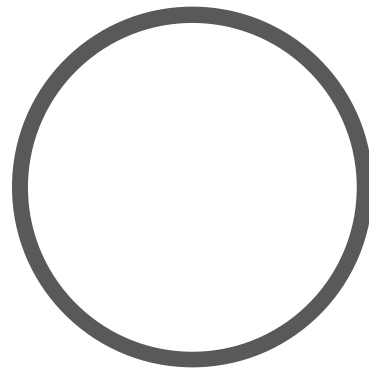

45 puddle
price list
Effective October 1, 2023

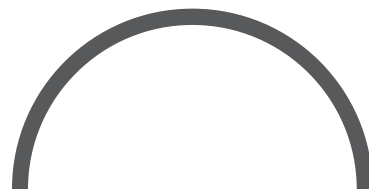



A base that seems to melt into the floor. Puddle is a clean and simple solution. Available on square, round, rectangle, squircle, and racetrack tables.

puddle

Puddle Base



D

Puddle Options

- LC Locking Casters**
are not available on Puddle tables.
- FD Folding Bases**
are not available on Puddle tables.
- NE Nesting Tables**
are not available on Puddle tables.
- FT Flip Tops**
are not available on Puddle tables.
- CH Chrome Finish**
available for \$475 per base. Brushed Steel is not available on Puddle tables.
- WM Wire Management**
Built-in wire management is available on one leg for \$139 per column.
- WMLC Wire Management Leg Covers 3"**
snap onto any leg and are \$79 each.
- SH Special Height**
can be added to any table:
+ \$72 per column for heights > 29"
+ \$39 per column for heights < 29"
Special height tables with tops larger than 36x72" must be custom quoted.
- FR Footring**
is available on Puddle tables for \$166.
- PB Powerbox Mounting Plate**
is available on disc bases for \$100.

Puddle Height Adjustable Options

- BL Counterbalanced and Short Balanced** are available on single disc bases. Available height adjustable finishes can be found on page 9.
- BLS** are available on single disc bases. Available height adjustable finishes can be found on page 9.
- NU Pneumatic** is available on Puddle disc base for \$387. For height option details, see page 19.

Puddle Top Shapes



Square p.158



Rectangle p.158



Round p.159



Squircle p.159



Racetrack p.159

puddle

Puddle Top Options

- QG Quick-Connect Ganging Brackets** can be added to any table for \$45 (includes 4 connectors per table).
- RC 3" Radius Corners** can be added to any table for \$61.
- GR Grommets** can be added to any table for \$45 each. To see specific locations, see page 227.

Puddle Edge Options

(corresponds with 3 columns of pricing)

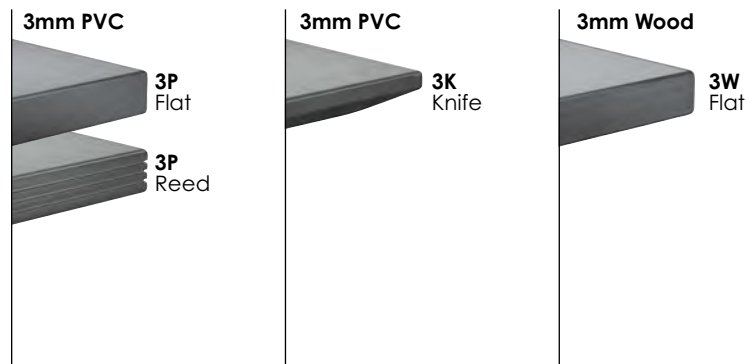

Square with Disc Base		Top Size	Base	Model Number	3P	3K	3W
	24 x 24	Static		45SQ2424D22	\$ 830	\$ 879	\$ 957
		Short Bal		45SQ2424D22BLS	1,745	1,794	1,873
	30 x 30	Static		45SQ3030D22	895	971	1,058
		Short Bal		45SQ3030D22BLS	1,811	1,886	1,973
		Count Bal		45SQ3030D22BL	1,811	1,886	1,973
	36 x 36	Static		45SQ3636D26	1,023	1,130	1,223
Short Bal			45SQ3636D26BLS	2,316	2,423	2,515	
Count Bal			45SQ3636D26BL	2,316	2,423	2,515	

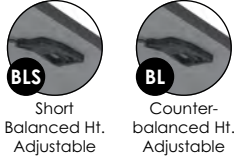

Rectangular with Disc Bases		Top Size	Base	Model Number	3P	3K	3W
	24 x 60	Static		45TC2460D22	\$ 1,562	\$ 1,668	\$ 1,790
		24 x 72	Static		45TC2472D22	1,612	1,739
	24 x 84	Static		45TC2484D22	1,795	1,961	2,096
	24 x 90 *	Static		45TC2490D22	1,854	2,043	2,174
	24 x 96 *	Static		45TC2496D22	1,854	2,043	2,189
	30 x 60	Static		45TC3060D22	1,615	1,742	1,862
	30 x 72	Static		45TC3072D22	1,671	1,822	1,953
	30 x 84	Static		45TC3084D22	1,894	2,100	2,219
	30 x 90 *	Static		45TC3090D22	1,967	2,201	2,313
	30 x 96 *	Static		45TC3096D22	1,967	2,201	2,327
	36 x 72	Static		45TC3672D26	1,887	2,085	2,195
	36 x 84	Static		45TC3684D26	2,130	2,376	2,479
	36 x 90 *	Static		45TC3690D26	2,216	2,495	2,587
	36 x 96 *	Static		45TC3696D26	2,216	2,495	2,602
	42 x 72	Static		45TC4272D26	2,051	2,298	2,386
	42 x 84	Static		45TC4284D26	2,234	2,521	2,608
	42 x 90 *	Static		45TC4290D26	2,330	2,655	2,728
	42 x 96 *	Static		45TC4296D26	2,330	2,655	2,742

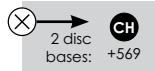

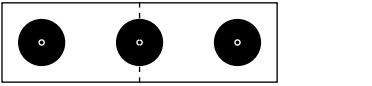







Rectangular with 3 Disc Bases		Top Size	Base	Model Number	3P	3K	3W
	42 x 120	Static		45TC42120D26(3)-TJ	\$ 3,361	\$ 3,844	\$ 3,870
	42 x 144	Static		45TC42144D26(3)-TJ	3,559	4,121	4,145



* \$200 NET surcharge per order for oversized pallet

For Puddle series table options, please reference pages 156-157.

Top Size	Base	Model Number	3P	3K	3W	Round with Disc Base
24 x 24	Static	45RD24D22	\$ 870	\$ 935	\$ 977	    <p>Short Balanced Ht. Adjustable</p> <p>Counter-balanced Ht. Adjustable</p>
	Short Bal	45RD24D22BLS	1,786	1,851	1,892	
30 x 30	Static	45RD30D22	959	1,060	1,097	
	Short Bal	45RD30D22BLS	1,875	1,975	2,013	
36 x 36	Static	45RD36D22	1,053	1,192	1,223	
	Short Bal	45RD36D22BLS	1,969	2,107	2,139	
	Count Bal	45RD36D22BL	1,969	2,107	2,139	
42 x 42	Static	45RD42D26	1,226	1,414	1,431	
	Short Bal	45RD42D26BLS	2,519	2,707	2,724	
	Count Bal	45RD42D26BL	2,519	2,707	2,724	

Top Size	Base	Model Number	3P	3K	3W	Squircle with Disc Base
24 x 24	Static	45SL24D22	\$ 1,055	\$ 1,194	\$ 1,205	    <p>Short Balanced Ht. Adjustable</p> <p>Counter-balanced Ht. Adjustable</p>
	Short Bal	45SL24D22BLS	1,971	2,110	2,120	
30 x 30	Static	45SL30D22	1,115	1,278	1,300	
	Short Bal	45SL30D22BLS	2,031	2,194	2,215	
	Count Bal	45SL30D22BL	2,031	2,194	2,215	
36 x 36	Static	45SL36D26	1,231	1,420	1,451	
	Short Bal	45SL36D26BLS	2,523	2,713	2,743	
	Count Bal	45SL36D26BL	2,523	2,713	2,743	

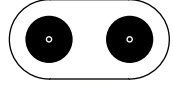
Top Size	Base	Model Number	3P	3K	3W	Racetrack with Disc Base
36 x 72	Static	45RT3672D26	\$ 2,111	\$ 2,398	\$ 2,405	 
36 x 84	Static	45RT3684D26	2,441	2,811	2,784	
36 x 90 *	Static	45RT3690D26	2,576	2,999	2,946	
36 x 96 *	Static	45RT3696D26	2,576	2,999	2,961	
42 x 84	Static	45RT4284D26	2,487	2,875	2,843	
42 x 90 *	Static	45RT4290D26	2,629	3,073	3,013	
42 x 96 *	Static	45RT4296D26	2,629	3,073	3,027	

CH ← ⊗
+569 2 disc bases:

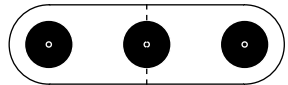
Top Size	Base	Model Number	3P	3K	3W	Racetrack with 3 Disc Base
42 x 120	Static	45RT42120D26(3)-TJ	\$ 3,913	\$ 4,617	\$ 4,434	 
42 x 144	Static	45RT42144D26(3)-TJ	4,224	5,053	4,834	

CH ← ⊗
+853 3 disc bases:

* \$200 NET surcharge per order for oversized pallet

For Puddle series table options, please reference pages 156-157.

tablex

71 exclaim
price list
Effective October 1, 2023





Exclaim is both simple, yet sophisticated. These angled square columns build a collection of attractive tables with a variety of base configurations.

Exclaim Base Configurations

exclaim



A Configuration



V Configuration



X Configuration



Exclaim Options

Angled 2" Column with Standard Glides

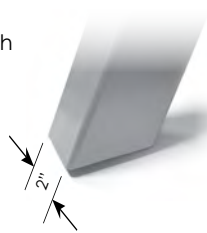

Angled 3" Column with Standard Glides

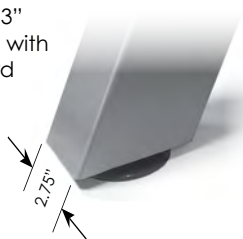

LC **Locking Casters** are not available on Exclaim tables.

FD **Folding Bases** are not available on Exclaim tables.

NE **Nesting Tables** are not available on Exclaim tables.

FT **Flip Tops** are not available on Exclaim tables.

PB **Powerbox Mounting Plate** is not available on Exclaim tables.

CH **Chrome Finish** ONLY available on Exclaim 3" angled columns at Standard or Lounge heights for \$119 per column. (Not available on 2" columns)

WMH **Wire Management Holes** Two built-in wire management mouse holes available for \$34 per leg on the 3" columns only. Not available on chrome.

MMLC **Magnetic Wire Management Leg Covers** Magnetically attaches onto any square leg and are \$71 each.

SH **Special Heights** of 42" are available on all standard Exclaim tables for \$56 per column. Special height of 18" is available on select Exclaim models shown on pages 164-165. Other custom heights are not available on Exclaim.

Exclaim Top Shapes



Rectangle
p.166



Boat
p.168



Racetrack
p.169



Elliptical
p.170



D-shaped
p.172



Square
p.173



Round
p.173

Exclaim Lounge Height Top Shapes



Square
p.164



Round
p.164



Rectangle
p.165

Exclaim Top Options

QG Quick-Connect Ganging Brackets can be added to any table for \$45 (includes 4 connectors per table).

RC 3" Radius Corners can be added to any table for \$61.

GR Grommets can be added to any table for \$45 each. To see specific locations, see page 227.

Exclaim Edge Options

(corresponds with 3 columns of pricing)

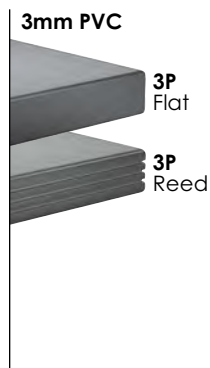

3 Heights Available

Lounge Height of 18" is available on square, round, and rectangular tables. These models are designated with a "-SH.18" in the model number and are listed on the next two pages.

Standard Height of 29" is shown on all standard models in the Exclaim line listed on pages 166-173. Custom heights outside of the three shown here are not available.

Standing Height of 42" is available on any standard Exclaim table. Simply add "-SH.42" to the model number and add \$53 per column to the list prices on pages 166-173.



SH.18 18" Lounge Height

18"H Square with 4 Columns	Top Size	Base	Model Number	3P	3K	3W
	24 x 24	Angled 2"	71SQ2424Q2-SH.18	\$ 958	\$ 1,007	\$ 1,085
	30 x 30	Angled 2"	71SQ3030Q2-SH.18	1,024	1,099	1,186
	36 x 36	Angled 2"	71SQ3636Q2-SH.18	1,103	1,210	1,302
	42 x 42	Angled 2"	71SQ4242Q2-SH.18	1,197	1,341	1,434
	48 x 48	Angled 2"	71SQ4848Q2-SH.18	1,304	1,491	1,581

18"H Round with 3 Columns	Top Size	Base	Model Number	3P	3K	3W
	24 x 24	Angled 2"	71RD24Q2(3)-SH.18	\$ 819	\$ 885	\$ 926

18"H Round with 4 Columns	Top Size	Base	Model Number	3P	3K	3W
	30 x 30	Angled 2"	71RD30Q2-SH.18	\$ 1,088	\$ 1,188	\$ 1,226
	36 x 36	Angled 2"	71RD36Q2-SH.18	1,182	1,320	1,352
	42 x 42	Angled 2"	71RD42Q2-SH.18	1,306	1,494	1,511
	48 x 48	Angled 2"	71RD48Q2-SH.18	1,341	1,543	1,572
	54 x 54	Angled 2"	71RD54Q2-SH.18	1,584	1,867	1,858
	60 x 60	Angled 2"	71RD60Q2-SH.18	1,612	1,907	1,912

For Exclaim table options, please reference pages 162-163.



SH.18 18" Lounge Height

Top Size	Base	Model Number	3P	3K	3W	18"H Rectangular with A Configuration
20 x 36	Angled 2"	71TC2036Q2.A-SH.18	\$ 1,017	\$ 1,089	\$ 1,169	
20 x 48	Angled 2"	71TC2048Q2.A-SH.18	1,075	1,171	1,262	
20 x 60	Angled 2"	71TC2060Q2.A-SH.18	1,102	1,209	1,321	
20 x 72	Angled 2"	71TC2072Q2.A-SH.18	1,153	1,280	1,405	
24 x 36	Angled 2"	71TC2436Q2.A-SH.18	1,017	1,089	1,178	
24 x 48	Angled 2"	71TC2448Q2.A-SH.18	1,075	1,171	1,272	
24 x 60	Angled 2"	71TC2460Q2.A-SH.18	1,102	1,209	1,330	
24 x 72	Angled 2"	71TC2472Q2.A-SH.18	1,153	1,280	1,414	
30 x 36	Angled 2"	71TC3036Q2.A-SH.18	1,060	1,150	1,241	
30 x 48	Angled 2"	71TC3048Q2.A-SH.18	1,132	1,251	1,349	
30 x 60	Angled 2"	71TC3060Q2.A-SH.18	1,155	1,283	1,403	
30 x 72	Angled 2"	71TC3072Q2.A-SH.18	1,212	1,362	1,494	
36 x 48	Angled 2"	71TC3648Q2.A-SH.18	1,190	1,331	1,426	
36 x 60	Angled 2"	71TC3660Q2.A-SH.18	1,276	1,452	1,550	
36 x 72	Angled 2"	71TC3672Q2.A-SH.18	1,331	1,529	1,639	

Top Size	Base	Model Number	3P	3K	3W	18"H Rectangular with V Configuration
24 x 36	Angled 2"	71TC2436Q2.V-SH.18	\$ 1,017	\$ 1,089	\$ 1,178	
24 x 48	Angled 2"	71TC2448Q2.V-SH.18	1,075	1,171	1,272	
24 x 60	Angled 2"	71TC2460Q2.V-SH.18	1,102	1,209	1,330	
24 x 72	Angled 2"	71TC2472Q2.V-SH.18	1,153	1,280	1,414	
30 x 36	Angled 2"	71TC3036Q2.V-SH.18	1,060	1,150	1,241	
30 x 48	Angled 2"	71TC3048Q2.V-SH.18	1,132	1,251	1,349	
30 x 60	Angled 2"	71TC3060Q2.V-SH.18	1,155	1,283	1,403	
30 x 72	Angled 2"	71TC3072Q2.V-SH.18	1,212	1,362	1,494	
36 x 48	Angled 2"	71TC3648Q2.V-SH.18	1,190	1,331	1,426	
36 x 60	Angled 2"	71TC3660Q2.V-SH.18	1,276	1,452	1,550	
36 x 72	Angled 2"	71TC3672Q2.V-SH.18	1,331	1,529	1,639	

For Exclaim table options, please reference pages 162-163.



exclaim



Rectangular with X Configuration	Top Size	Base	Model Number	3P	3K	3W
 	20 x 36	Angled 2"	71TC2036Q2.X	\$ 1,017	\$ 1,089	\$ 1,169
	20 x 48	Angled 2"	71TC2048Q2.X	1,075	1,171	1,262
	20 x 60	Angled 2"	71TC2060Q2.X	1,102	1,209	1,321
	20 x 72	Angled 2"	71TC2072Q2.X	1,238	1,364	1,490
	20 x 84	Angled 2"	71TC2084Q2.X	1,336	1,502	1,626
	20 x 90 *	Angled 2"	71TC2090Q2.X	1,394	1,583	1,705
	20 x 96 *	Angled 2"	71TC2096Q2.X	1,394	1,583	1,719
	24 x 36	Angled 2"	71TC2436Q2.X	1,017	1,089	1,178
	24 x 48	Angled 2"	71TC2448Q2.X	1,075	1,171	1,272
	24 x 60	Angled 2"	71TC2460Q2.X	1,102	1,209	1,330
	24 x 72	Angled 2"	71TC2472Q2.X	1,238	1,364	1,499
	24 x 84	Angled 2"	71TC2484Q2.X	1,336	1,502	1,636
	24 x 90 *	Angled 2"	71TC2490Q2.X	1,394	1,583	1,715
	24 x 96 *	Angled 2"	71TC2496Q2.X	1,394	1,583	1,729
	30 x 36	Angled 2"	71TC3036Q2.X	1,060	1,150	1,241
	30 x 48	Angled 2"	71TC3048Q2.X	1,132	1,251	1,349
	30 x 60	Angled 2"	71TC3060Q2.X	1,155	1,283	1,403
	30 x 72	Angled 2"	71TC3072Q2.X	1,212	1,362	1,494
	30 x 84	Angled 2"	71TC3084Q2.X	1,435	1,640	1,759
	30 x 90 *	Angled 2"	71TC3090Q2.X	1,507	1,742	1,853
30 x 96 *	Angled 2"	71TC3096Q2.X	1,507	1,742	1,868	



Rectangular with V Configuration	Top Size	Base	Model Number	3P	3K	3W
 	36 x 48	Angled 2"	71TC3648Q2.V	\$ 1,190	\$ 1,331	\$ 1,426
	36 x 60	Angled 2"	71TC3660Q2.V	1,276	1,452	1,550
	36 x 72	Angled 2"	71TC3672Q2.V	1,331	1,529	1,639
	36 x 84	Angled 2"	71TC3684Q2.V	1,574	1,819	1,923
	36 x 90 *	Angled 2"	71TC3690Q2.V	1,659	1,939	2,031
	36 x 96 *	Angled 2"	71TC3696Q2.V	1,659	1,939	2,045
	42 x 60	Angled 3"	71TC4260Q3.V	1,445	1,651	1,741
	42 x 72	Angled 3"	71TC4272Q3.V	1,548	1,796	1,883
	42 x 84	Angled 3"	71TC4284Q3.V	1,732	2,019	2,106
	42 x 90 *	Angled 3"	71TC4290Q3.V	1,828	2,153	2,225
	42 x 96 *	Angled 3"	71TC4296Q3.V	1,828	2,153	2,240
	48 x 60	Angled 3"	71TC4860Q3.V	1,473	1,691	1,786
	48 x 72	Angled 3"	71TC4872Q3.V	1,637	1,919	1,995
	48 x 84	Angled 3"	71TC4884Q3.V	1,732	2,019	2,120
	48 x 90 *	Angled 3"	71TC4890Q3.V	1,829	2,155	2,241
	48 x 96 *	Angled 3"	71TC4896Q3.V	1,829	2,155	2,255

* \$200 NET surcharge per order for oversized pallet

For Exclaim table options, please reference pages 162-163.

Top Size	Base	Model Number	3P	3K	3W	Rectangular with V6 Configuration
42 x 120	Angled 3"	71TC42120Q3.V6-TJ	\$2,692	\$3,175	\$3,201	 
42 x 144	Angled 3"	71TC42144Q3.V6-TJ	2,890	3,452	3,476	
48 x 120	Angled 3"	71TC48120Q3.V6-TJ	2,704	3,192	3,229	
48 x 144	Angled 3"	71TC48144Q3.V6-TJ	2,904	3,472	3,506	

Top Size	Base	Model Number	3P	3K	3W	Rectangular with A Configuration
42 x 60	Angled 3"	71TC4260Q3.A	\$1,445	\$1,651	\$1,741	 
42 x 72	Angled 3"	71TC4272Q3.A	1,548	1,796	1,883	
42 x 84	Angled 3"	71TC4284Q3.A	1,732	2,019	2,106	
42 x 90 *	Angled 3"	71TC4290Q3.A	1,828	2,153	2,225	
42 x 96 *	Angled 3"	71TC4296Q3.A	1,828	2,153	2,240	
48 x 60	Angled 3"	71TC4860Q3.A	1,473	1,691	1,786	
48 x 72	Angled 3"	71TC4872Q3.A	1,637	1,919	1,995	
48 x 84	Angled 3"	71TC4884Q3.A	1,732	2,019	2,120	
48 x 90 *	Angled 3"	71TC4890Q3.A	1,829	2,155	2,241	
48 x 96 *	Angled 3"	71TC4896Q3.A	1,829	2,155	2,255	

Top Size	Base	Model Number	3P	3K	3W	Rectangular with A6 Configuration
42 x 120	Angled 3"	71TC42120Q3.A6-TJ	\$2,692	\$3,175	\$3,201	 
42 x 144	Angled 3"	71TC42144Q3.A6-TJ	2,890	3,452	3,476	
48 x 120	Angled 3"	71TC48120Q3.A6-TJ	2,704	3,192	3,229	
48 x 144	Angled 3"	71TC48144Q3.A6-TJ	2,904	3,472	3,506	

* \$200 NET surcharge per order for oversized pallet

For Exclaim table options, please reference pages 162-163.

exclaim

Boat-shaped with V Configuration	Top Size	Base	Model Number	3P	3K	3W
	30 x 42 x 84	Angled 3"	71BT3084Q3.V	\$ 1,988	\$ 2,378	\$ 2,344
	30 x 42 x 90 *	Angled 3"	71BT3090Q3.V	2,126	2,571	2,510
	30 x 42 x 96 *	Angled 3"	71BT3096Q3.V	2,126	2,571	2,525
	36 x 48 x 84	Angled 3"	71BT3684Q3.V	2,125	2,569	2,503
	36 x 48 x 90 *	Angled 3"	71BT3690Q3.V	2,282	2,789	2,690
	36 x 48 x 96 *	Angled 3"	71BT3696Q3.V	2,282	2,789	2,704



Boat-shaped with V6 Configuration	Top Size	Base	Model Number	3P	3K	3W
	36 x 48 x 120	Angled 3"	71BT36120Q3.V6-TJ	\$ 3,262	\$ 3,973	\$ 3,793
	36 x 48 x 144	Angled 3"	71BT36144Q3.V6-TJ	3,576	4,412	4,196



Boat-shaped with A Configuration	Top Size	Base	Model Number	3P	3K	3W
	36 x 48 x 84	Angled 3"	71BT3684Q3.A	\$ 2,125	\$ 2,569	\$ 2,503
	36 x 48 x 90 *	Angled 3"	71BT3690Q3.A	2,282	2,789	2,690
	36 x 48 x 96 *	Angled 3"	71BT3696Q3.A	2,282	2,789	2,704

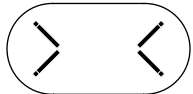

Boat-shaped with A6 Configuration	Top Size	Base	Model Number	3P	3K	3W
	36 x 48 x 120	Angled 3"	71BT36120Q3.A6-TJ	\$ 3,262	\$ 3,973	\$ 3,793
	36 x 48 x 144	Angled 3"	71BT36144Q3.A6-TJ	3,576	4,412	4,196



* \$200 NET surcharge per order for oversized pallet

For Exclaim table options, please reference pages 162-163.

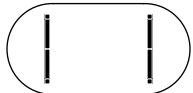
Top Size	Base	Model Number	3P	3K	3W	Racetrack with V Configuration
36 x 60	Angled 2"	71RT3660Q2.V	\$1,554	\$1,842	\$1,819	 
36 x 72	Angled 2"	71RT3672Q2.V	1,554	1,842	1,848	
36 x 84	Angled 2"	71RT3684Q2.V	1,885	2,254	2,228	
36 x 90 *	Angled 2"	71RT3690Q2.V	2,019	2,443	2,390	
36 x 96 *	Angled 2"	71RT3696Q2.V	2,019	2,443	2,404	
42 x 84	Angled 3"	71RT4284Q3.V	1,985	2,373	2,341	
42 x 90 *	Angled 3"	71RT4290Q3.V	2,126	2,571	2,510	
42 x 96 *	Angled 3"	71RT4296Q3.V	2,126	2,571	2,525	
48 x 84	Angled 3"	71RT4884Q3.V	2,282	2,789	2,676	
48 x 90 *	Angled 3"	71RT4890Q3.V	2,282	2,789	2,690	
48 x 96 *	Angled 3"	71RT4896Q3.V	2,282	2,789	2,704	

Top Size	Base	Model Number	3P	3K	3W	Racetrack with V6 Configuration
42 x 120	Angled 3"	71RT42120Q3.V6-TJ	\$3,245	\$3,949	\$3,766	 
42 x 144	Angled 3"	71RT42144Q3.V6-TJ	3,556	4,384	4,165	
48 x 120	Angled 3"	71RT48120Q3.V6-TJ	3,262	3,973	3,793	
48 x 144	Angled 3"	71RT48144Q3.V6-TJ	3,577	4,413	4,196	

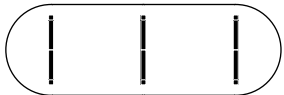

Top Size	Base	Model Number	3P	3K	3W	Racetrack with A Configuration
42 x 84	Angled 3"	71RT4284Q3.A	\$1,985	\$2,373	\$2,341	 
42 x 90 *	Angled 3"	71RT4290Q3.A	2,126	2,571	2,510	
42 x 96 *	Angled 3"	71RT4296Q3.A	2,126	2,571	2,525	
48 x 84	Angled 3"	71RT4884Q3.A	2,282	2,789	2,676	
48 x 90 *	Angled 3"	71RT4890Q3.A	2,282	2,789	2,690	
48 x 96 *	Angled 3"	71RT4896Q3.A	2,282	2,789	2,704	



Top Size	Base	Model Number	3P	3K	3W	Racetrack with A6 Configuration
42 x 120	Angled 3"	71RT42120Q3.A6-TJ	\$3,245	\$3,949	\$3,766	 
42 x 144	Angled 3"	71RT42144Q3.A6-TJ	3,556	4,384	4,165	
48 x 120	Angled 3"	71RT48120Q3.A6-TJ	3,262	3,973	3,793	
48 x 144	Angled 3"	71RT48144Q3.A6-TJ	3,577	4,413	4,196	

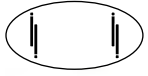

* \$200 NET surcharge per order for oversized pallet

For Exclaim table options, please reference pages 162-163.

exclaim

Elliptical with X Configuration	Top Size	Base	Model Number	3P	3K	3W
	30 x 54	Angled 2"	71EL3054Q2.X	\$ 1,290	\$ 1,471	\$ 1,493
	30 x 60	Angled 2"	71EL3060Q2.X	1,338	1,538	1,557
	36 x 60	Angled 2"	71EL3660Q2.X	1,439	1,680	1,680
	36 x 72	Angled 2"	71EL3672Q2.X	1,554	1,842	1,830
	36 x 84	Angled 2"	71EL3684Q2.X	1,800	2,136	2,110
	36 x 90 *	Angled 2"	71EL3690Q2.X	1,915	2,297	2,248
	36 x 96 *	Angled 2"	71EL3696Q2.X	1,915	2,297	2,259

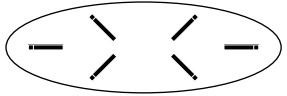
Elliptical with V Configuration	Top Size	Base	Model Number	3P	3K	3W
	42 x 72	Angled 3"	71EL4272Q3.V	\$ 1,769	\$ 2,105	\$ 2,068
	42 x 84	Angled 3"	71EL4284Q3.V	1,985	2,373	2,319
	42 x 90 *	Angled 3"	71EL4290Q3.V	2,129	2,574	2,488
	42 x 96 *	Angled 3"	71EL4296Q3.V	2,129	2,574	2,500
	48 x 72	Angled 3"	71EL4872Q3.V	1,885	2,266	2,206
	48 x 84	Angled 3"	71EL4884Q3.V	2,283	2,790	2,658
	48 x 90 *	Angled 3"	71EL4890Q3.V	2,283	2,790	2,669
	48 x 96 *	Angled 3"	71EL4896Q3.V	2,283	2,790	2,680

Elliptical with V6 Configuration	Top Size	Base	Model Number	3P	3K	3W
	42 x 120	Angled 3"	71EL42120Q3.V6-TJ	\$ 3,245	\$ 3,949	\$ 3,725
	42 x 144	Angled 3"	71EL42144Q3.V6-TJ	3,556	4,384	4,113
	48 x 120	Angled 3"	71EL48120Q3.V6-TJ	3,262	3,973	3,756
	48 x 144	Angled 3"	71EL48144Q3.V6-TJ	3,577	4,413	4,147

* \$200 NET surcharge per order for oversized pallet

For Exclaim table options, please reference pages 162-163.



exclaim

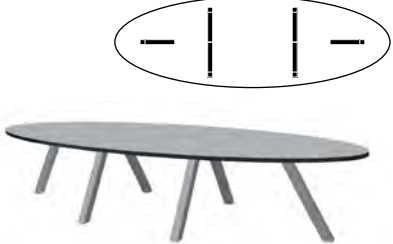

Top Size	Base	Model Number	3P	3K	3W	Elliptical with A Configuration
42 x 72	Angled 3"	71EL4272Q3.A	\$1,662	\$1,991	\$1,976	
42 x 84	Angled 3"	71EL4284Q3.A	1,879	2,259	2,230	
42 x 90 *	Angled 3"	71EL4290Q3.A	2,019	2,456	2,397	
42 x 96 *	Angled 3"	71EL4296Q3.A	2,019	2,456	2,409	
48 x 72	Angled 3"	71EL4872Q3.A	1,775	2,149	2,112	
48 x 84	Angled 3"	71EL4884Q3.A	2,170	2,667	2,564	
48 x 90 *	Angled 3"	71EL4890Q3.A	2,170	2,667	2,575	
48 x 96 *	Angled 3"	71EL4896Q3.A	2,170	2,667	2,588	

Top Size	Base	Model Number	3P	3K	3W	Elliptical with A6 Configuration
42 x 120	Angled 3"	71EL42120Q3.A6-TJ	\$3,245	\$3,949	\$3,725	
42 x 144	Angled 3"	71EL42144Q3.A6-TJ	3,556	4,384	4,113	
48 x 120	Angled 3"	71EL48120Q3.A6-TJ	3,262	3,973	3,756	
48 x 144	Angled 3"	71EL48144Q3.A6-TJ	3,577	4,413	4,147	

* \$200 NET surcharge per order for oversized pallet

For Exclaim table options, please reference pages 162-163.

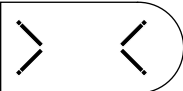
D-shaped with X Configuration	Top Size	Base	Model Number	3P	3K	3W
	24 x 36	Angled 2"	71D2436Q2.X	\$ 1,075	\$ 1,170	\$ 1,230
	24 x 48	Angled 2"	71D2448Q2.X	1,154	1,282	1,346
	24 x 60	Angled 2"	71D2460Q2.X	1,234	1,393	1,463
	24 x 72	Angled 2"	71D2472Q2.X	1,314	1,505	1,579
	24 x 84	Angled 2"	71D2484Q2.X	1,239	1,367	1,518
	24 x 90 *	Angled 2"	71D2490Q2.X	1,518	1,757	1,839
	24 x 96 *	Angled 2"	71D2496Q2.X	1,558	1,813	1,897
	30 x 48	Angled 2"	71D3048Q2.X	1,234	1,393	1,445
	30 x 60	Angled 2"	71D3060Q2.X	1,334	1,533	1,584
	30 x 72	Angled 2"	71D3072Q2.X	1,433	1,672	1,722
	30 x 84	Angled 2"	71D3084Q2.X	1,618	1,897	1,945
	30 x 90 *	Angled 2"	71D3090Q2.X	1,667	1,966	2,014
	30 x 96 *	Angled 2"	71D3096Q2.X	1,717	2,036	2,083

D-shaped with V Configuration	Top Size	Base	Model Number	3P	3K	3W
	36 x 48	Angled 2"	71D3648Q2.V	\$ 1,314	\$ 1,505	\$ 1,544
	36 x 60	Angled 2"	71D3660Q2.V	1,433	1,672	1,704
	36 x 72	Angled 2"	71D3672Q2.V	1,553	1,839	1,865
	36 x 84	Angled 2"	71D3684Q2.V	1,797	2,131	2,150
	36 x 90 *	Angled 2"	71D3690Q2.V	1,857	2,215	2,230
	36 x 96 *	Angled 2"	71D3696Q2.V	1,916	2,299	2,310
	42 x 60	Angled 3"	71D4260Q3.V	2,034	2,475	2,367
	42 x 72	Angled 3"	71D4272Q3.V	2,034	2,475	2,396
	42 x 84	Angled 3"	71D4284Q3.V	2,119	2,560	2,509
	42 x 90 *	Angled 3"	71D4290Q3.V	2,198	2,671	2,611
	42 x 96 *	Angled 3"	71D4296Q3.V	2,276	2,781	2,712
	48 x 60	Angled 3"	71D4860Q3.V	2,045	2,491	2,390
	48 x 72	Angled 3"	71D4872Q3.V	2,045	2,491	2,419
	48 x 84	Angled 3"	71D4884Q3.V	2,130	2,576	2,533
	48 x 90 *	Angled 3"	71D4890Q3.V	2,210	2,687	2,635
	48 x 96 *	Angled 3"	71D4896Q3.V	2,289	2,799	2,737
	54 x 54	Angled 3"	71D5454Q3.V	1,916	2,310	2,245
	60 x 60	Angled 3"	71D6060Q3.V	1,925	2,324	2,282

* \$200 NET surcharge per order for oversized pallet

For Exclaim table options, please reference pages 162-163.

Top Size	Base	Model Number	3P	3K	3W	D-shaped with A Configuration
42 x 60	Angled 3"	71D4260Q3.A	\$2,034	\$2,475	\$2,367	
42 x 72	Angled 3"	71D4272Q3.A	2,034	2,475	2,396	
42 x 84	Angled 3"	71D4284Q3.A	2,119	2,560	2,509	
42 x 90 *	Angled 3"	71D4290Q3.A	2,198	2,671	2,611	
42 x 96 *	Angled 3"	71D4296Q3.A	2,276	2,781	2,712	
48 x 60	Angled 3"	71D4860Q3.A	2,045	2,491	2,390	
48 x 72	Angled 3"	71D4872Q3.A	2,045	2,491	2,419	
48 x 84	Angled 3"	71D4884Q3.A	2,130	2,576	2,533	
48 x 90 *	Angled 3"	71D4890Q3.A	2,210	2,687	2,635	
48 x 96 *	Angled 3"	71D4896Q3.A	2,289	2,799	2,737	
54 x 54	Angled 3"	71D5454Q3.A	1,916	2,310	2,245	
60 x 60	Angled 3"	71D6060Q3.A	1,925	2,324	2,282	

Top Size	Base	Model Number	3P	3K	3W	Square with 4 Columns
36 x 36	Angled 2"	71SQ3636Q2	\$ 1,103	\$ 1,210	\$ 1,302	
42 x 42	Angled 2"	71SQ4242Q2	1,197	1,341	1,434	
	Angled 3"	71SQ4242Q3	1,251	1,395	1,488	
48 x 48	Angled 2"	71SQ4848Q2	1,304	1,491	1,581	
	Angled 3"	71SQ4848Q3	1,358	1,545	1,635	
54 x 54	Angled 3"	71SQ5454Q3	1,520	1,756	1,837	
60 x 60	Angled 3"	71SQ6060Q3	1,655	1,945	2,015	

Top Size	Base	Model Number	3P	3K	3W	Round with 3 Columns
42 x 42	Angled 2"	71RD42Q2(3)	\$ 1,127	\$ 1,315	\$ 1,332	
48 x 48	Angled 3"	71RD48Q3(3)	1,202	1,404	1,433	

Top Size	Base	Model Number	3P	3K	3W	Round with 4 Columns
48 x 48	Angled 2"	71RD48Q2	\$ 1,341	\$ 1,543	\$ 1,572	
54 x 54	Angled 3"	71RD54Q3	1,638	1,921	1,912	
60 x 60	Angled 3"	71RD60Q3	1,666	1,961	1,966	

* \$200 NET surcharge per order for oversized pallet

For Exclaim table options, please reference pages 162-163.

exclaim



tablex

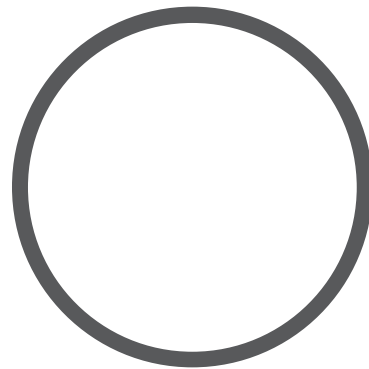

74 vertiGo
price list
Effective October 1, 2023

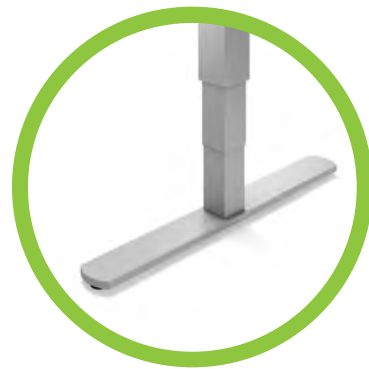

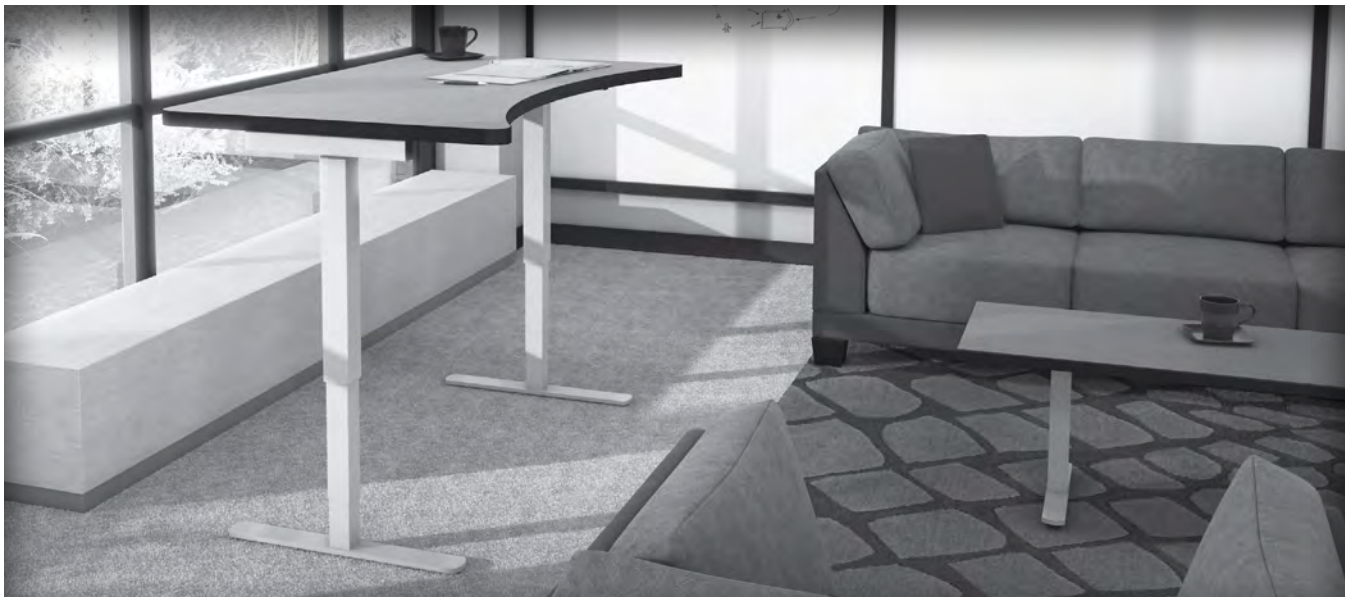

Adjusting one's work surface height has become the most personal and impactful detail within a workspace. VertiGo is designed to go from sit-to-stand, and any height in between, with ease. Match with static or nesting tables for a cohesive look throughout a space.

VertiGo Base Styles

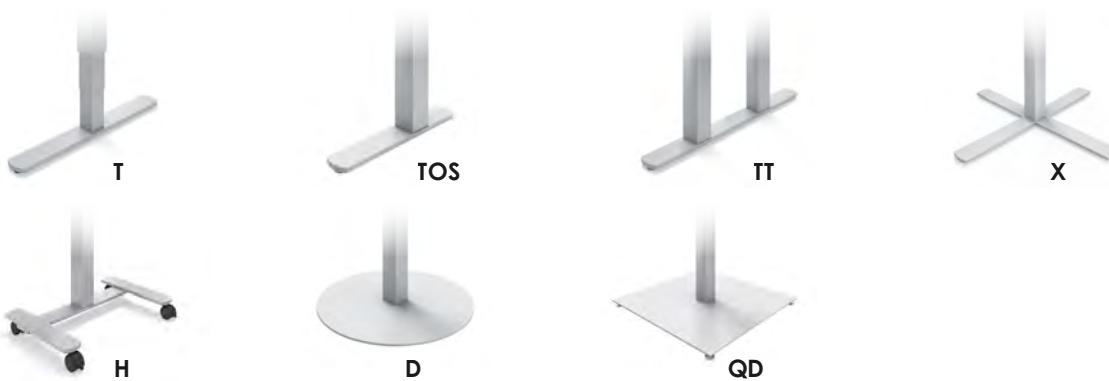

VertiGo Options

Standard Glides



Locking Casters



- LC Locking Casters**
can be added to any table for \$111 per set of four.
- FD Folding Bases**
are not available on VertiGo tables.
- NE Nesting Tables**
priced accordingly with locking casters.
- FT Flip Tops**
available on X-based and H-based tables for \$138. Not available on counterbalanced tables.

- WM Wire Management**
Built-in wire management is not available on VertiGo tables.
- MMLC Magnetic Wire Management Leg Covers**
Magnetically attaches onto any square leg and are \$71 each.
- OS Offset T-bases**
available for \$39 per table. Offset is not available on 18"d tables or 30"d nesting tables less than 60" wide.

- SH Special Height** can be added to any table:
+ \$72 per column for heights > 29"
+ \$39 per column for heights < 29"
Special height tables with tops larger than 36x72" must be custom quoted.
- FR Footring** available for \$166 per disc base. Not available for height adjustable bases.
- CH Chrome Finish** is not available on VertiGo tables.

VertiGo Height Adjustable Options

RA Ratchet
NE RA is available on T-bases and nesting for \$536 list per table. Available height adjustable finishes can be found on page 9.

CR Hand Crank
NE CR is available on most T-, X-, and L-bases and some nesting models as listed. Available height adjustable finishes can be found on page 9.

BL Counterbalanced and Short Balanced
BLS are available on disc and X-bases. Available height adjustable finishes can be found on page 9.

EH Electric Height is available on T- and TT-bases and are available in two finishes:

- 37 Satin Silver
- 57 Jet

Two-leg counterbalanced units are only available in three finishes:

- 30 Pearl
- 37 Satin Silver
- 57 Jet

VertiGo Top Shapes



Rectangle p.180, 187



Boat p.184



Racetrack p.185



Elliptical p.186



Kidney Bean p.187



Square p.188



Round p.189



D-shaped p.190



Half Round p.192



Trapezoid p.193



Squiracle p.193

VertiGo Top Options

QG Quick-Connect Ganging Brackets can be added to any table for \$45 (includes 4 connectors per table).

RC 3" Radius Corners can be added to any table for \$61.

GR Grommets can be added to any table for \$45 each. To see specific locations, see page 227.

VertiGo Edge Options

(corresponds with 3 columns of pricing)

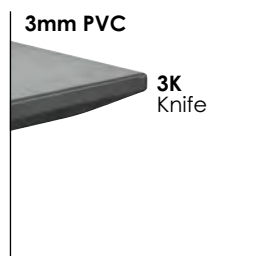
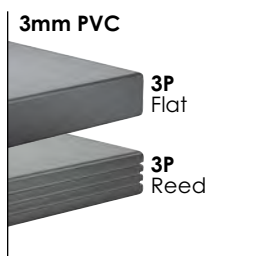

Ratchet Height Adjustability

Ratchet height adjustability is available on most tables in the VertiGo line... T-bases, X-bases, and even disc bases. Simply lift the top near the base's mounting plate, and the ratchet clicks into place. With a range of 9.45" the ratchet works in thirteen increments of .78". To reset to the lowest position just lift past its highest point.

will be adjusted to ensure that the range of mobile tables is consistent with that of static tables.

To specify:
All available ratchet models are priced in the following pages. They are denoted by the "RA" at the end of the model number.

Example:
74TC2060T18RA-3P
20x60" **ratchet** table
\$1,393 List Price

Want to use VertiGo on the go? Casters can be added, and the height of the base



Both bases are clearly marked to ensure your table is level.

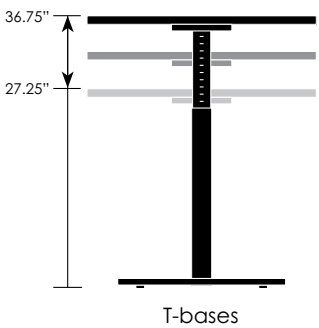

T-bases

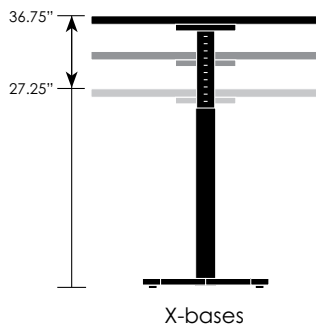

X-bases
Disc Bases
H-bases

Nesting Ratchet

Ratchet height adjustability is also available on many of the nesting T-base models in the VertiGo line. All available nesting models are denoted by the "NE" at the end of the model number. To add the ratchet option to those models, change the "NE" to "NERA" and add **\$536** to the list price.

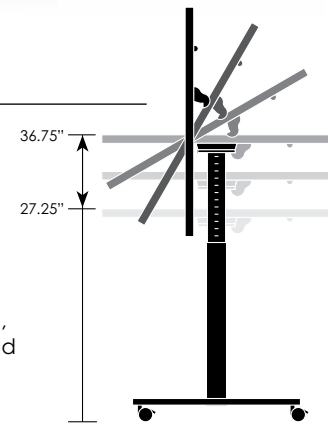

Example:
74TC2060T18NERA-3P
20x60" **nesting ratchet** table
\$1,677 + 536 = \$2,213 List Price

vertiGo

Manual Hand Crank Height Adjustability

Need the flexibility of infinite adjustability without the budget for counterbalanced bases? Our manual hand crank offers a cost-effective alternative.

"CR" at the end of the model number.

Example:
74TC2060T18CR-3P
20x60" **hand crank** table
\$1,559 List Price

To specify:
All available hand crank models are priced in the following pages. They are denoted by the

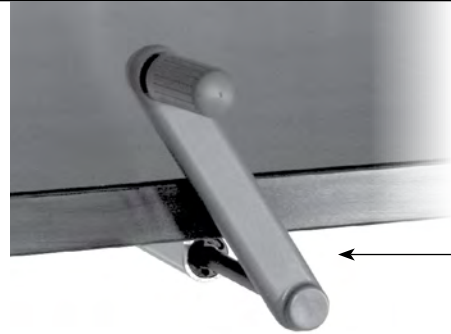

Raise and lower with turn of the crank

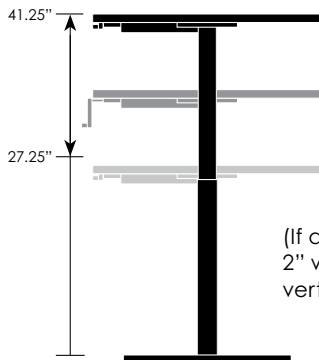

Crank Bases

(If adding locking casters, 2" will be added to overall vertical height.)

Nesting Hand Crank

Introducing hand crank height adjustable tables that nest! Only available on rectangular tables 20x60" to 36x72". These models are denoted by the "NECR" at the end of the model number.

Example:
74TC2060T18NECR-3P
20x60" **nesting hand crank** table
\$2,435 List Price



Electric Height Adjustability

Electric height adjustability gives you the ability to adjust tables at the push of a button. The standard memory keypad will remember your four favorite heights. Available on both VertiGo T and TT-bases, this option works great in private offices or even in conference rooms.

To specify:
All available electric models are priced in the following pages. They are denoted by the "EH" at the end of the model number.

Example:
74TC2060T18EH-3P
20x60" **electric height** table
\$3,078 List Price

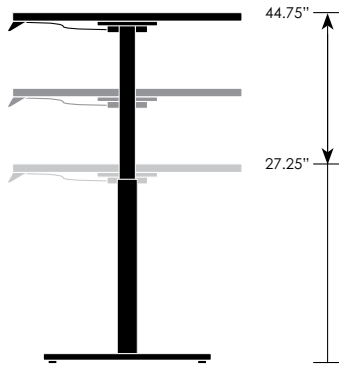

Electric T-bases

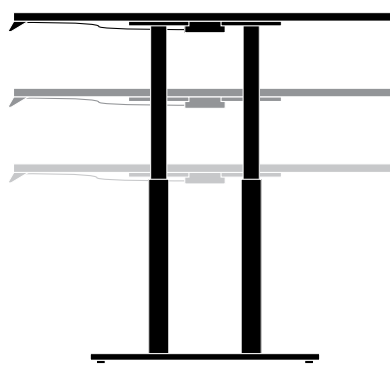

Electric TT-bases

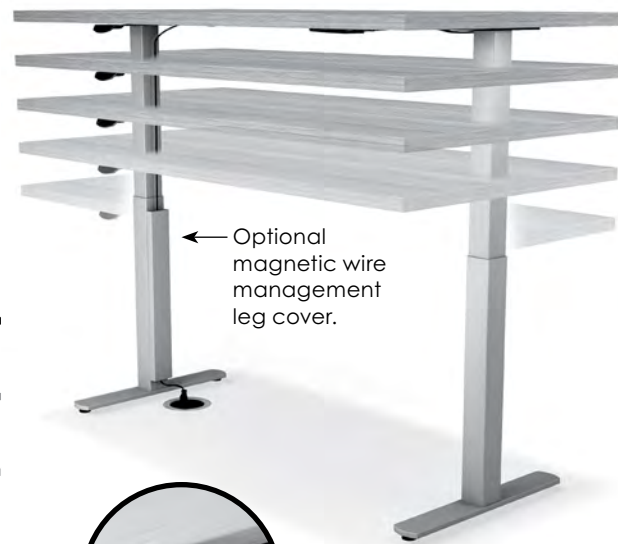

← Optional magnetic wire management leg cover.



Retractable Memory Keypad

Counterbalanced & Short Balanced Height Adjustability

Counterbalanced tables go from seated-to-standing height, while the short balanced goes from coffee-to-seated height. Available on tables using single column disc or X-bases, these tables are easy to adjust. Simply squeeze the small handle underneath and gently move the top to your desired height. It's that easy.

Want to use VertiGo on the go? Simply add 2" to each vertical measurement to account for the added height of locking casters.

To specify:
All available counterbalanced models are priced in the following pages. They are denoted by the "BL" or "BLS" (for short balanced) at the end of the model number.

Example:
74RD36X32BL-3P
36" round **counterbalanced** table
\$1,525 List Price

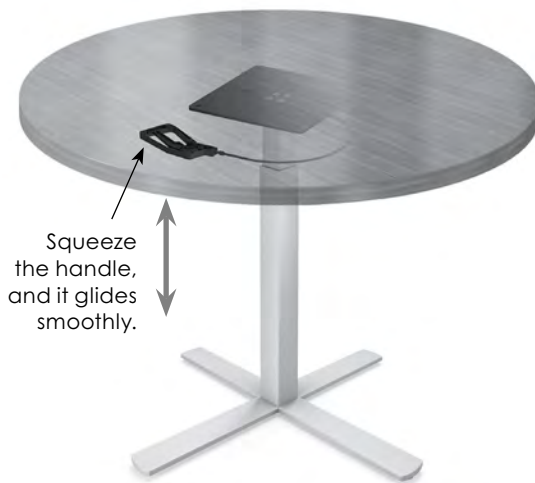

Squeeze the handle, and it glides smoothly.

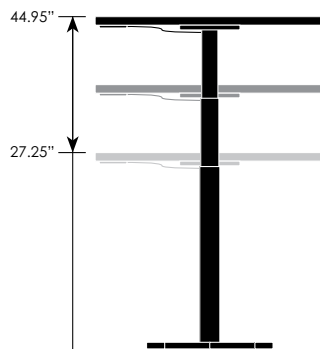

BL Counterbalanced disc or X-bases

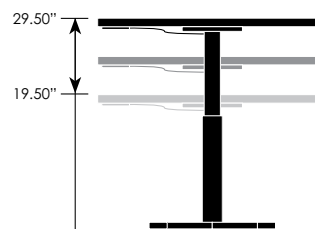

BLS Short balanced disc or X-bases

vertiGo

Rectangular with T-bases	Top Size	Base	Model Number	3P	3K	3W
	20 x 36	Static	74TC2036T18	\$ 772	\$ 844	\$ 924
		Nesting	74TC2036T18NE	1,591	1,664	1,744
		Ratchet	74TC2036T18RA	1,308	1,380	1,460
		Crank	74TC2036T18CR	1,473	1,546	1,626
		Electric	74TC2036T18EH	2,993	3,065	3,145
	20 x 48	Static	74TC2048T18	830	926	1,017
		Nesting	74TC2048T18NE	1,650	1,746	1,837
		Ratchet	74TC2048T18RA	1,366	1,462	1,553
		Crank	74TC2048T18CR	1,532	1,628	1,719
		Count Bal	74TC2048T18BL	2,612	2,707	2,798
		Electric	74TC2048T18EH	3,051	3,147	3,238
	20 x 60	Static	74TC2060T18	857	964	1,076
		Nesting	74TC2060T18NE	1,677	1,784	1,895
		Ratchet	74TC2060T18RA	1,393	1,500	1,612
		Crank	74TC2060T18CR	1,559	1,666	1,777
Nest/Crank		74TC2060T18NECR	2,435	2,542	2,654	
Count Bal		74TC2060T18BL	2,669	2,776	2,887	
Electric		74TC2060T18EH	3,078	3,185	3,297	
20 x 72	Static	74TC2072T18	908	1,034	1,160	
	Nesting	74TC2072T18NE	1,968	2,095	2,220	
	Ratchet	74TC2072T18RA	1,529	1,656	1,781	
	Crank	74TC2072T18CR	1,695	1,821	1,947	
	Nest/Crank	74TC2072T18NECR	2,538	2,665	2,790	
	Count Bal	74TC2072T18BL	2,820	2,947	3,073	
	Electric	74TC2072T18EH	3,214	3,341	3,466	
20 x 84	Static	74TC2084T18	1,091	1,257	1,381	
	Nesting	74TC2084T18NE	2,066	2,232	2,357	
	Electric	74TC2084T18EH	3,312	3,478	3,602	
20 x 90 *	Static	74TC2090T18	1,149	1,338	1,460	
	Nesting	74TC2090T18NE	2,125	2,314	2,436	
	Electric	74TC2090T18EH	3,370	3,560	3,681	
20 x 96 *	Static	74TC2096T18	1,149	1,338	1,474	
	Nesting	74TC2096T18NE	2,125	2,314	2,450	
	Electric	74TC2096T18EH	3,370	3,560	3,695	
24 x 36	Static	74TC2436T22	791	863	952	
	Nesting	74TC2436T22NE	1,623	1,695	1,784	
	Ratchet	74TC2436T22RA	1,327	1,399	1,489	
	Crank	74TC2436T22CR	1,489	1,561	1,651	
	Electric	74TC2436T22EH	3,007	3,080	3,169	
24 x 48	Static	74TC2448T22	849	945	1,046	
	Nesting	74TC2448T22NE	1,669	1,765	1,865	
	Ratchet	74TC2448T22RA	1,385	1,481	1,582	
	Crank	74TC2448T22CR	1,548	1,643	1,744	
	Count Bal	74TC2448T22BL	2,631	2,726	2,827	
	Electric	74TC2448T22EH	3,066	3,162	3,262	

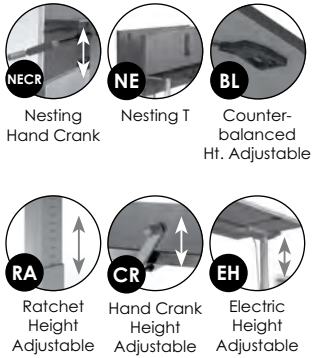

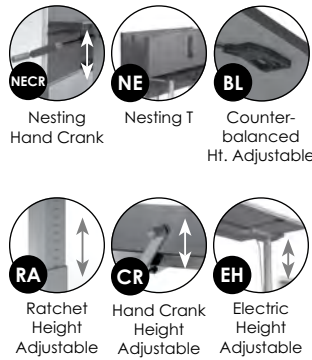

* \$200 NET surcharge per order for oversized pallet

For VertiGo table options, please reference pages 176-177.

Top Size	Base	Model Number	3P	3K	3W	Rectangular with T-bases
24 x 60	Static	74TC2460T22	\$ 876	\$ 983	\$ 1,104	
	Nesting	74TC2460T22NE	1,696	1,803	1,924	
	Ratchet	74TC2460T22RA	1,412	1,519	1,640	
	Crank	74TC2460T22CR	1,575	1,681	1,803	
	Nest/Crank	74TC2460T22NECR	2,452	2,559	2,680	
	Count Bal	74TC2460T22BL	2,688	2,795	2,916	
	Electric	74TC2460T22EH	3,093	3,200	3,321	
	Battery/Nest	74TC2460T22BEHNE	3,873	3,980	4,101	
24 x 72	Static	74TC2472T22	927	1,054	1,188	
	Nesting	74TC2472T22NE	1,987	2,114	2,249	
	Ratchet	74TC2472T22RA	1,463	1,590	1,725	
	Crank	74TC2472T22CR	1,625	1,752	1,887	
	Nest/Crank	74TC2472T22NECR	2,555	2,682	2,816	
	Count Bal	74TC2472T22BL	2,756	2,883	3,018	
	Electric	74TC2472T22EH	3,144	3,270	3,405	
	Battery/Nest	74TC2472T22BEHNE	4,165	4,291	4,426	
24 x 84	Static	74TC2484T22	1,110	1,276	1,410	
	Nesting	74TC2484T22NE	2,085	2,251	2,385	
	Electric	74TC2484T22EH	3,326	3,492	3,627	
24 x 90 *	Static	74TC2490T22	1,168	1,358	1,489	
	Nesting	74TC2490T22NE	2,144	2,333	2,464	
	Electric	74TC2490T22EH	3,385	3,574	3,705	
24 x 96 *	Static	74TC2496T22	1,168	1,358	1,503	
	Nesting	74TC2496T22NE	2,144	2,333	2,479	
	Electric	74TC2496T22EH	3,385	3,574	3,720	
30 x 36	Static	74TC3036T26	853	943	1,034	
	Nesting	74TC3036T26NE	1,673	1,763	1,854	
	Ratchet	74TC3036T26RA	1,390	1,480	1,571	
	Crank	74TC3036T26CR	1,550	1,640	1,731	
	Electric	74TC3036T26EH	3,069	3,159	3,250	
30 x 48	Static	74TC3048T26	926	1,044	1,142	
	Nesting	74TC3048T26NE	1,745	1,864	1,962	
	Ratchet	74TC3048T26RA	1,463	1,581	1,679	
	Crank	74TC3048T26CR	1,623	1,741	1,839	
	Count Bal	74TC3048T26BL	2,709	2,827	2,925	
30 x 60	Static	74TC3060T26	948	1,076	1,196	
	Nesting	74TC3060T26NE	1,768	1,896	2,016	
	Ratchet	74TC3060T26RA	1,485	1,613	1,733	
	Crank	74TC3060T26CR	1,645	1,773	1,893	
	Nest/Crank	74TC3060T26NECR	2,520	2,648	2,768	
	Count Bal	74TC3060T26BL	2,762	2,889	3,009	
	Electric	74TC3060T26EH	3,164	3,292	3,412	
	Battery/Nest	74TC3060T26BEHNE	3,943	4,071	4,191	

* \$200 NET surcharge per order for oversized pallet

For VertiGo table options, please reference pages 176-177.



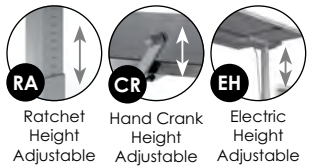
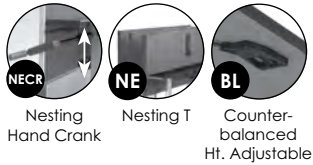

Rectangular with T-bases	Top Size	Base	Model Number	3P	3K	3W	
 	30 x 72	Static	74TC3072T26	\$1,005	\$1,155	\$1,287	
		Nesting	74TC3072T26NE	2,065	2,216	2,347	
		Ratchet	74TC3072T26RA	1,542	1,692	1,824	
		Crank	74TC3072T26CR	1,702	1,852	1,984	
		Nest/Crank	74TC3072T26NECR	2,629	2,779	2,911	
		Count Bal	74TC3072T26BL	2,833	2,983	3,115	
		Electric	74TC3072T26EH	3,221	3,371	3,503	
		Battery/Nest	74TC3072T26BEHNE	4,241	4,391	4,523	
		30 x 84	Static	74TC3084T26	1,228	1,433	1,552
			Nesting	74TC3084T26NE	2,203	2,409	2,528
Electric	74TC3084T26EH		3,444	3,649	3,768		
30 x 90 *	Static	74TC3090T26	1,300	1,535	1,647		
	Electric	74TC3090T26EH	3,516	3,751	3,862		
30 x 96 *	Static	74TC3096T26	1,300	1,535	1,661		
	Electric	74TC3096T26EH	3,516	3,751	3,877		
36 x 48	Static	74TC3648T26	983	1,124	1,219		
	Nesting	74TC3648T26NE	1,943	2,084	2,179		
	Ratchet	74TC3648T26RA	1,520	1,661	1,757		
	Crank	74TC3648T26CR	1,680	1,821	1,916		
	Count Bal	74TC3648T26BL	2,766	2,907	3,003		
	Electric	74TC3648T26EH	3,199	3,340	3,435		
36 x 60	Static	74TC3660T26	1,069	1,245	1,343		
	Nesting	74TC3660T26NE	2,103	2,279	2,377		
	Ratchet	74TC3660T26RA	1,606	1,783	1,880		
	Crank	74TC3660T26CR	1,766	1,942	2,040		
	Nest/Crank	74TC3660T26NECR	2,693	2,869	2,967		
	Count Bal	74TC3660T26BL	2,883	3,059	3,157		
	Electric	74TC3660T26EH	3,285	3,461	3,559		
	Battery/Nest	74TC3660T26BEHNE	4,279	4,455	4,553		
	36 x 72	Static	74TC3672T26	1,124	1,322	1,432	
		Nesting	74TC3672T26NE	2,184	2,382	2,493	
Ratchet		74TC3672T26RA	1,661	1,859	1,969		
Crank		74TC3672T26CR	1,821	2,019	2,129		
Nest/Crank		74TC3672T26NECR	2,748	2,946	3,056		
Count Bal		74TC3672T26BL	2,952	3,150	3,260		
Electric		74TC3672T26EH	3,340	3,538	3,648		
Battery/Nest		74TC3672T26BEHNE	4,360	4,558	4,668		
36 x 84		Static	74TC3684T26	1,367	1,612	1,716	
	Electric	74TC3684T26EH	3,583	3,828	3,932		
36 x 90 *	Static	74TC3690T26	1,452	1,732	1,824		
	Electric	74TC3690T26EH	3,668	3,948	4,040		
36 x 96 *	Static	74TC3696T26	1,452	1,732	1,838		
	Electric	74TC3696T26EH	3,668	3,948	4,054		





vertiGo

* \$200 NET surcharge per order for oversized pallet



For VertiGo table options, please reference pages 176-177.

Top Size	Base	Model Number	3P	3K	3W	Rectangular with TT-bases
42 x 60	Static	74TC4260TT32	\$ 1,939	\$ 2,145	\$ 2,235	    <p>Nesting TT Electric Height Adjustable</p>
	Nesting	74TC4260TT32NE	3,096	3,302	3,392	
	Electric	74TC4260TT32EH	6,208	6,414	6,504	
42 x 72	Static	74TC4272TT32	2,042	2,290	2,377	
	Nesting	74TC4272TT32NE	3,199	3,446	3,534	
	Electric	74TC4272TT32EH	6,311	6,559	6,646	
42 x 84	Static	74TC4284TT32	2,226	2,513	2,599	
	Electric	74TC4284TT32EH	6,495	6,782	6,868	
42 x 90 *	Static	74TC4290TT32	2,322	2,647	2,719	
	Electric	74TC4290TT32EH	6,590	6,916	6,988	
42 x 96 *	Static	74TC4296TT32	2,322	2,647	2,733	
	Electric	74TC4296TT32EH	6,591	6,916	7,002	
48 x 60	Static	74TC4860TT36	1,977	2,194	2,290	
	Nesting	74TC4860TT36NE	3,134	3,351	3,447	
	Electric	74TC4860TT36EH	8,973	9,191	9,286	
48 x 72	Static	74TC4872TT36	2,140	2,423	2,499	
	Nesting	74TC4872TT36NE	3,297	3,580	3,655	
	Electric	74TC4872TT36EH	9,137	9,420	9,495	
48 x 84	Static	74TC4884TT36	2,236	2,523	2,624	
	Electric	74TC4884TT36EH	9,232	9,519	9,620	
48 x 90 *	Static	74TC4890TT36	2,333	2,658	2,745	
	Electric	74TC4890TT36EH	9,329	9,655	9,741	
48 x 96 *	Static	74TC4896TT36	2,333	2,658	2,759	
	Electric	74TC4896TT36EH	9,329	9,655	9,756	

Top Size	Base	Model Number	3P	3K	3W	Rectangular with 3 TT-bases
42 x 120	Static	74TC42120TT32(3)-TJ	\$ 3,348	\$ 3,831	\$ 3,857	  <p>LC N/A SH quote ← 3 bases: X</p>
42 x 144	Static	74TC42144TT32(3)-TJ	3,546	4,108	4,132	
48 x 120	Static	74TC48120TT36(3)-TJ	3,375	3,863	3,899	
48 x 144	Static	74TC48144TT36(3)-TJ	3,575	4,143	4,177	



* \$200 NET surcharge per order for oversized pallet

For VertiGo table options, please reference pages 176-177.

Boat-shaped with T-bases	Top Size	Base	Model Number	3P	3K	3W
 	30 x 42 x 84	Static	74BT3084T26	\$ 1,727	\$ 2,117	\$ 2,083
		Electric	74BT3084T26EH	3,943	4,332	4,299
	30 x 42 x 90 *	Static	74BT3090T26	1,865	2,310	2,249
		Electric	74BT3090T26EH	4,081	4,526	4,465
	30 x 42 x 96 *	Static	74BT3096T26	1,865	2,310	2,264
		Electric	74BT3090T26EH	4,081	4,526	4,480





EH
Electric
Height
Adjustable

Boat-shaped with TT-bases	Top Size	Base	Model Number	3P	3K	3W
 	36 x 48 x 84	Static	74BT3684TT36	\$ 2,629	\$ 3,073	\$ 3,006
		Electric	74BT3684TT36EH	9,625	10,069	10,003
	36 x 48 x 90 *	Static	74BT3690TT36	2,786	3,293	3,194
		Electric	74BT3690TT36EH	9,782	10,289	10,190
	36 x 48 x 96 *	Static	74BT3696TT36	2,786	3,293	3,208
		Electric	74BT3696TT36EH	9,782	10,289	10,204



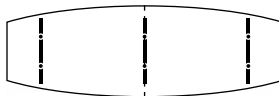















EH
Electric
Height
Adjustable



Boat-shaped with 3 TT-bases	Top Size	Base	Model Number	3P	3K	3W
 	36 x 48 x 120	Static	74BT36120TT36(3)-TJ	\$ 3,933	\$ 4,643	\$ 4,463
	36 x 48 x 144	Static	74BT36144TT36(3)-TJ	4,247	5,083	4,866
	 <p>3 bases: LC N/A SH quote</p>					

* \$200 NET surcharge per order for oversized pallet

For VertiGo table options, please reference pages 176-177.

Top Size	Base	Model Number	3P	3K	3W	Racetrack with T-bases
36 x 60	Static	74RT3660T26	\$1,348	\$1,635	\$1,612	 
	Nesting	74RT3660T26NE	2,308	2,595	2,572	
	Ratchet	74RT3660T26RA	1,885	2,172	2,150	
	Crank	74RT3660T26CR	2,045	2,332	2,309	
	Count Bal	74RT3660T26BL	3,161	3,449	3,426	
	Electric	74RT3660T26EH	3,563	3,851	3,828	
36 x 72	Static	74RT3672T26	1,348	1,635	1,641	
	Nesting	74RT3672T26NE	2,382	2,669	2,675	
	Ratchet	74RT3672T26RA	1,885	2,172	2,178	
	Crank	74RT3672T26CR	2,045	2,332	2,338	
	Count Bal	74RT3672T26BL	3,176	3,463	3,469	
	Electric	74RT3672T26EH	3,563	3,851	3,857	
36 x 84	Static	74RT3684T26	1,678	2,047	2,021	 
	Electric	74RT3684T26EH	3,894	4,263	4,236	
36 x 90 *	Static	74RT3690T26	1,812	2,236	2,183	  
	Electric	74RT3690T26EH	4,028	4,452	4,399	
36 x 96 *	Static	74RT3696T26	1,812	2,236	2,197	  
	Electric	74RT3696T26EH	4,028	4,452	4,413	

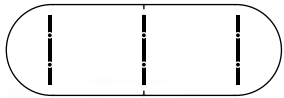

Top Size	Base	Model Number	3P	3K	3W	Racetrack with TT-bases
42 x 84	Static	74RT4284TT32	\$2,479	\$2,867	\$2,835	
	Electric	74RT4284TT32EH	6,748	7,136	7,103	
42 x 90 *	Static	74RT4290TT32	2,620	3,065	3,004	
	Electric	74RT4290TT32EH	6,889	7,333	7,273	
42 x 96 *	Static	74RT4296TT32	2,620	3,065	3,019	
	Electric	74RT4296TT32EH	6,889	7,333	7,288	
48 x 84	Static	74RT4884TT36	2,786	3,293	3,179	
	Electric	74RT4884TT36EH	9,782	10,289	10,176	
48 x 90 *	Static	74RT4890TT36	2,786	3,293	3,194	
	Electric	74RT4890TT36EH	9,782	10,289	10,190	
48 x 96 *	Static	74RT4896TT36	2,786	3,293	3,208	
	Electric	74RT4896TT36EH	9,782	10,289	10,204	

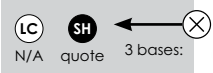

Top Size	Base	Model Number	3P	3K	3W	Racetrack with TT-bases
42 x 120	Static	74RT42120TT32(3)-TJ	\$3,901	\$4,604	\$4,421	 
42 x 144	Static	74RT42144TT32(3)-TJ	4,212	5,040	4,821	
48 x 120	Static	74RT48120TT36(3)-TJ	3,933	4,644	4,464	
48 x 144	Static	74RT48144TT36(3)-TJ	4,247	5,084	4,867	

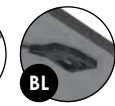

* \$200 NET surcharge per order for oversized pallet

For VertiGo table options, please reference pages 176-177.

Elliptical with T-bases	Top Size	Base	Model Number	3P	3K	3W
 <div style="display: flex; justify-content: space-around; margin-top: 10px;"> <div style="text-align: center;">  <p>RA Ratchet Height Adjustable</p> </div> <div style="text-align: center;">  <p>EH Electric Height Adjustable</p> </div> <div style="text-align: center;">  <p>BL Counter- balanced Ht. Adjustable</p> </div> </div>	30 x 54	Static	74EL3054T22	\$ 1,064	\$ 1,245	\$ 1,267
		Ratchet	74EL3054T22RA	1,600	1,781	1,803
		Count Bal	74EL3054T22BL	2,861	3,043	3,108
		Electric	74EL3054T22EH	3,280	3,462	3,484
	30 x 60	Static	74EL3060T22	1,112	1,312	1,331
		Ratchet	74EL3060T22RA	1,648	1,849	1,867
		Count Bal	74EL3060T22BL	2,924	3,124	3,189
		Electric	74EL3060T22EH	3,328	3,529	3,548
	36 x 60	Static	74EL3660T26	1,232	1,473	1,473
		Ratchet	74EL3660T26RA	1,769	2,011	2,010
		Count Bal	74EL3660T26BL	3,046	3,287	3,336
		Electric	74EL3660T26EH	3,448	3,689	3,689
36 x 72	Static	74EL3672T26	1,348	1,635	1,623	
	Ratchet	74EL3672T26RA	1,885	2,172	2,160	
	Count Bal	74EL3672T26BL	3,176	3,463	3,506	
	Electric	74EL3672T26EH	3,563	3,851	3,839	
36 x 84	Static	74EL3684T26	1,593	1,929	1,903	
	Electric	74EL3684T26EH	3,809	4,145	4,119	
36 x 90 *	Static	74EL3690T26	1,709	2,090	2,041	
	Electric	74EL3690T26EH	3,924	4,306	4,257	
36 x 96 *	Static	74EL3696T26	1,709	2,090	2,052	
	Electric	74EL3696T26EH	3,924	4,306	4,268	

Elliptical with TT-bases	Top Size	Base	Model Number	3P	3K	3W
 <div style="margin-top: 10px;">  <p>EH Electric Height Adjustable</p> </div>	42 x 72	Static	74EL4272TT32	\$ 2,263	\$ 2,599	\$ 2,561
		Electric	74EL4272TT32EH	6,532	6,868	6,830
	42 x 84	Static	74EL4284TT32	2,479	2,867	2,813
		Electric	74EL4284TT32EH	6,748	7,136	7,082
	42 x 90 *	Static	74EL4290TT32	2,623	3,068	2,982
		Electric	74EL4290TT32EH	6,891	7,337	7,251
	42 x 96 *	Static	74EL4296TT32	2,623	3,068	2,994
		Electric	74EL4296TT32EH	6,891	7,337	7,262
	48 x 72	Static	74EL4872TT36	2,388	2,770	2,710
		Electric	74EL4872TT36EH	9,385	9,767	9,706
	48 x 84	Static	74EL4884TT36	2,786	3,293	3,161
		Electric	74EL4884TT36EH	9,783	10,290	10,158
	48 x 90 *	Static	74EL4890TT36	2,786	3,293	3,173
		Electric	74EL4890TT36EH	9,783	10,290	10,169
	48 x 96 *	Static	74EL4896TT36	2,786	3,293	3,184
		Electric	74EL4896TT36EH	9,783	10,290	10,180

* \$200 NET surcharge per order for oversized pallet

For VertiGo table options, please reference pages 176-177.







Top Size	Base	Model Number	3P	3K	3W	Elliptical with 3 TT-bases
42 x 120	Static	74EL42120TT32(3)-TJ	\$3,901	\$4,604	\$4,381	
42 x 144	Static	74EL42144TT32(3)-TJ	4,212	5,040	4,769	
48 x 120	Static	74EL48120TT36(3)-TJ	3,933	4,644	4,427	
48 x 144	Static	74EL48144TT36(3)-TJ	4,247	5,084	4,818	





LC N/A SH quote 3 bases: X





Top Size	Base	Model Number	3P	3K	3W	Rectangle with H-base
18 x 30	Static	74TC1830H1524	\$ 1,076	\$ 1,131	\$ 1,205	
	Ratchet	74TC1830H1524RA	1,273	1,328	1,402	
	Count Bal	74TC1830H1524BL	1,666	1,721	1,795	
18 x 36	Static	74TC1836H1524	1,076	1,131	1,219	
	Ratchet	74TC1836H1524RA	1,273	1,328	1,416	
	Count Bal	74TC1836H1524BL	1,666	1,721	1,809	
20 x 30	Static	74TC2030H1524	1,090	1,151	1,225	
	Ratchet	74TC2030H1524RA	1,287	1,348	1,422	
	Count Bal	74TC2030H1524BL	1,680	1,740	1,815	
20 x 36	Static	74TC2036H1524	1,119	1,192	1,272	
	Ratchet	74TC2036H1524RA	1,317	1,389	1,469	
	Count Bal	74TC2036H1524BL	1,709	1,781	1,861	

Top Size	Base	Model Number	3P	3K	3W	Kidney Bean with H-base
18 x 30	Static	74KB1830H1524	\$ 1,281	\$ 1,418	\$ 1,442	
	Ratchet	74KB1830H1524RA	1,479	1,616	1,639	
	Count Bal	74KB1830H1524BL	1,871	2,008	2,032	
18 x 36	Static	74KB1836H1524	1,295	1,438	1,473	
	Ratchet	74KB1836H1524RA	1,492	1,635	1,670	
	Count Bal	74KB1836H1524BL	1,885	2,027	2,063	
20 x 30	Static	74KB2030H1524	1,284	1,422	1,450	
	Ratchet	74KB2030H1524RA	1,481	1,619	1,647	
	Count Bal	74KB2030H1524BL	1,874	2,012	2,040	
20 x 36	Static	74KB2036H1524	1,299	1,444	1,483	
	Ratchet	74KB2036H1524RA	1,497	1,641	1,680	
	Count Bal	74KB2036H1524BL	1,889	2,033	2,073	

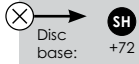
For VertiGo table options, please reference pages 176-177.

Square with X-base	Top Size	Base	Model Number	3P	3K	3W
  <div style="display: flex; flex-wrap: wrap;"> <div style="width: 50%;">  <p>RA Ratchet Height Adjustable</p> </div> <div style="width: 50%;">  <p>CR Hand Crank Height Adjustable</p> </div> <div style="width: 50%;">  <p>BLS Short Balanced Ht. Adjustable</p> </div> <div style="width: 50%;">  <p>BL Counter-balanced Ht. Adjustable</p> </div> </div>	24 x 24	Static	74SQ2424X22	\$ 782	\$ 831	\$ 909
	Ratchet	74SQ2424X22RA	979	1,028	1,106	
	Crank	74SQ2424X22CR	1,053	1,102	1,180	
	Short Bal	74SQ2424X22BLS	1,268	1,317	1,395	
	30 x 30	Static	74SQ3030X26	867	942	1,029
	Ratchet	74SQ3030X26RA	1,064	1,139	1,226	
	Crank	74SQ3030X26CR	1,136	1,211	1,298	
	Short Bal	74SQ3030X26BLS	1,349	1,424	1,512	
	36 x 36	Static	74SQ3636X32	965	1,072	1,165
	Short Bal	74SQ3636X32BLS	1,446	1,553	1,646	
	Count Bal	74SQ3636X32BL	1,446	1,553	1,646	
	42 x 42	Static	74SQ4242X36	1,078	1,222	1,315
Short Bal	74SQ4242X36BLS	1,556	1,700	1,793		
Count Bal	74SQ4242X36BL	1,556	1,700	1,793		

Square with Square Disc Base	Top Size	Base	Model Number	3P	3K	3W
  <div style="display: flex; flex-wrap: wrap;"> <div style="width: 33%;">  <p>BLS Short Balanced Ht. Adjustable</p> </div> <div style="width: 33%;">  <p>BL Counter-balanced Ht. Adjustable</p> </div> <div style="width: 33%;">  <p>RA Ratchet Height Adjustable</p> </div> </div> <div style="margin-top: 10px;">  <p>SH Disc base: +72</p> </div>	24 x 24	Static	74SQ2424QD16	\$ 794	\$ 843	\$ 922
	Ratchet	74SQ2424QD16RA	998	1,047	1,125	
	Short Bal	74SQ2424QD16BLS	1,446	1,495	1,573	
	30 x 30	Static	74SQ3030QD16	860	935	1,022
	Ratchet	74SQ3030QD16RA	1,063	1,138	1,226	
	Short Bal	74SQ3030QD16BLS	1,511	1,586	1,674	
	36 x 36	Static	74SQ3636QD20	978	1,085	1,178
	Short Bal	74SQ3636QD20BLS	1,631	1,738	1,830	
	Count Bal	74SQ3636QD20BL	1,631	1,738	1,830	
	42 x 42	Static	74SQ4242QD26	1,201	1,345	1,438
	Short Bal	74SQ4242QD26BLS	1,846	1,990	2,083	
	Count Bal	74SQ4242QD26BL	1,846	1,990	2,083	

Square with TT-bases	Top Size	Base	Model Number	3P	3K	3W
  <div style="display: flex; flex-wrap: wrap;"> <div style="width: 50%;">  <p>NE Nesting TT</p> </div> <div style="width: 50%;">  <p>EH Electric Height Adjustable</p> </div> </div>	48 x 48	Static	74SQ4848TT36	\$ 1,862	\$ 2,049	\$ 2,139
	Nesting	74SQ4848TT36NE	3,096	3,284	3,373	
	Electric	74SQ4848TT36EH	8,858	9,046	9,135	

For VertiGo table options, please reference pages 176-177.

Top Size	Base	Model Number	3P	3K	3W	Round with X-base
24 x 24	Static	74RD24X22	\$ 822	\$ 887	\$ 929	
	Ratchet	74RD24X22RA	1,020	1,085	1,126	
	Crank	74RD24X22CR	1,093	1,158	1,200	
	Short Bal	74RD24X22BLS	1,309	1,374	1,415	
30 x 30	Static	74RD30X26	931	1,031	1,069	
	Ratchet	74RD30X26RA	1,128	1,228	1,266	
	Crank	74RD30X26CR	1,200	1,300	1,338	
	Short Bal	74RD30X26BLS	1,413	1,514	1,551	
36 x 36	Static	74RD36X32	1,044	1,182	1,214	
	Short Bal	74RD36X32BLS	1,525	1,663	1,695	
	Count Bal	74RD36X32BL	1,525	1,663	1,695	
42 x 42	Static	74RD42X32	1,168	1,356	1,373	
	Short Bal	74RD42X32BLS	1,649	1,837	1,854	
	Count Bal	74RD42X32BL	1,649	1,837	1,854	
48 x 48	Static	74RD48X36	1,222	1,424	1,453	
	Short Bal	74RD48X36BLS	1,700	1,902	1,931	
	Count Bal	74RD48X36BL	1,700	1,902	1,931	

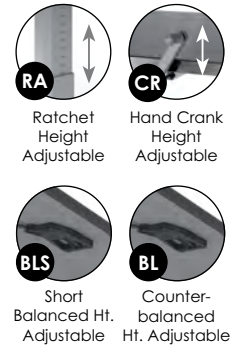



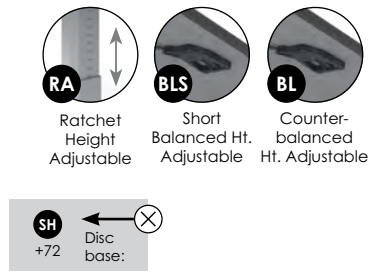

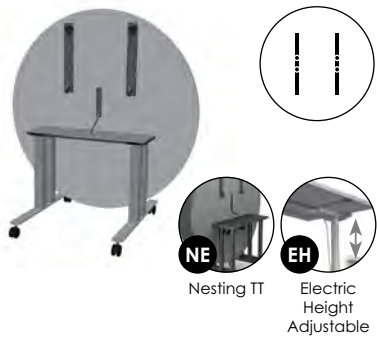

Top Size	Base	Model Number	3P	3K	3W	Round with Disc Base
24 x 24	Static	74RD24D20	\$ 835	\$ 900	\$ 941	
	Ratchet	74RD24D20RA	1,038	1,103	1,145	
	Short Bal	74RD24D20BLS	1,429	1,494	1,535	
30 x 30	Static	74RD30D20	924	1,025	1,062	
	Ratchet	74RD30D20RA	1,127	1,228	1,265	
	Short Bal	74RD30D20BLS	1,518	1,618	1,656	
36 x 36	Static	74RD36D24	1,057	1,195	1,227	
	Short Bal	74RD36D24BLS	1,954	2,092	2,124	
	Count Bal	74RD36D24BL	1,954	2,092	2,124	
42 x 42	Static	74RD42D24	1,181	1,369	1,386	
	Short Bal	74RD42D24BLS	2,078	2,266	2,283	
	Count Bal	74RD42D24BL	2,078	2,266	2,283	
48 x 48	Static	74RD48D32	1,345	1,547	1,576	
	Short Bal	74RD48D32BLS	2,236	2,438	2,467	
	Count Bal	74RD48D32BL	2,236	2,438	2,467	



Top Size	Base	Model Number	3P	3K	3W	Round with TT-bases
48 x 48	Static	74RD48TT32	\$ 1,889	\$ 2,091	\$ 2,120	
	Nesting	74RD48TT32NE	3,123	3,325	3,354	
	Electric	74RD48TT32EH	6,158	6,360	6,389	
54 x 54	Static	74RD54TT32	2,132	2,415	2,406	
	Nesting	74RD54TT32NE	3,326	3,610	3,600	
	Electric	74RD54TT32EH	6,401	6,684	6,675	
60 x 60	Static	74RD60TT36	2,170	2,464	2,469	
	Nesting	74RD60TT36NE	3,365	3,659	3,664	
	Electric	74RD60TT36EH	9,166	9,461	9,466	

For VertiGo table options, please reference pages 176-177.

D-shaped with T-bases	Top Size	Base	Model Number	3P	3K	3W
  <div style="display: flex; justify-content: space-around; margin-top: 20px;"> <div style="text-align: center;">  <p>BL Counter-balanced Ht. Adjustable</p> </div> <div style="text-align: center;">  <p>EH Electric Height Adjustable</p> </div> <div style="text-align: center;">  <p>RA Ratchet Height Adjustable</p> </div> <div style="text-align: center;">  <p>CR Hand Crank Height Adjustable</p> </div> </div>	24 x 36	Static	74D2436T22	\$ 849	\$ 944	\$1,004
		Ratchet	74D2436T22RA	1,385	1,481	1,540
		Crank	74D2436T22CR	1,547	1,643	1,703
		Electric	74D2436T22EH	3,066	3,161	3,221
	24 x 48	Static	74D2448T22	928	1,056	1,120
		Ratchet	74D2448T22RA	1,465	1,592	1,657
		Crank	74D2448T22CR	1,627	1,754	1,819
		Count Bal	74D2448T22BL	2,710	2,837	2,902
		Electric	74D2448T22EH	3,145	3,273	3,337
	24 x 60	Static	74D2460T22	1,008	1,167	1,237
		Ratchet	74D2460T22RA	1,544	1,704	1,773
		Crank	74D2460T22CR	1,707	1,866	1,935
		Count Bal	74D2460T22BL	2,820	2,979	3,049
		Electric	74D2460T22EH	3,225	3,384	3,454
	24 x 72	Static	74D2472T22	1,088	1,279	1,353
		Ratchet	74D2472T22RA	1,624	1,815	1,889
	Crank	74D2472T22CR	1,786	1,977	2,052	
	Count Bal	74D2472T22BL	2,917	3,108	3,183	
	Electric	74D2472T22EH	3,304	3,496	3,570	
24 x 84	Static	74D2484T22	1,252	1,475	1,554	
	Electric	74D2484T22EH	3,469	3,692	3,771	
24 x 90 *	Static	74D2490T22	1,292	1,531	1,613	
	Electric	74D2490T22EH	3,509	3,748	3,829	
24 x 96 *	Static	74D2496T22	1,332	1,587	1,671	
	Electric	74D2496T22EH	3,549	3,804	3,888	
30 x 48	Static	74D3048T26	1,027	1,187	1,239	
	Ratchet	74D3048T26RA	1,564	1,724	1,776	
	Crank	74D3048T26CR	1,724	1,884	1,935	
	Count Bal	74D3048T26BL	2,810	2,970	3,022	
	Electric	74D3048T26EH	3,243	3,402	3,454	
30 x 60	Static	74D3060T26	1,127	1,326	1,377	
	Ratchet	74D3060T26RA	1,664	1,863	1,914	
	Crank	74D3060T26CR	1,824	2,023	2,074	
	Count Bal	74D3060T26BL	2,941	3,140	3,191	
	Electric	74D3060T26EH	3,343	3,542	3,593	

* \$200 NET surcharge per order for oversized pallet

For VertiGo table options, please reference pages 176-177.

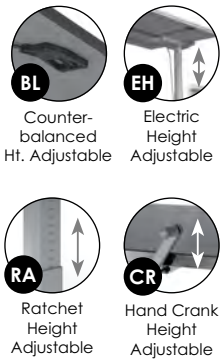
Top Size	Base	Model Number	3P	3K	3W	D-shaped with T-bases
30 x 72	Static	74D3072T26	\$ 1,226	\$ 1,465	\$ 1,515	
	Ratchet	74D3072T26RA	1,764	2,002	2,052	
	Crank	74D3072T26CR	1,923	2,162	2,212	
	Count Bal	74D3072T26BL	3,054	3,293	3,343	
	Electric	74D3072T26EH	3,442	3,681	3,731	
30 x 84	Static	74D3084T26	1,411	1,690	1,738	
	Electric	74D3084T26EH	3,627	3,906	3,954	
30 x 90 *	Static	74D3090T26	1,461	1,759	1,807	
	Electric	74D3090T26EH	3,676	3,975	4,023	
30 x 96 *	Static	74D3096T26	1,510	1,829	1,876	
	Electric	74D3096T26EH	3,726	4,045	4,092	
36 x 48	Static	74D3648T26	1,107	1,298	1,337	
	Ratchet	74D3648T26RA	1,644	1,835	1,875	
	Crank	74D3648T26CR	1,804	1,995	2,034	
	Count Bal	74D3648T26BL	2,890	3,081	3,121	
	Electric	74D3648T26EH	3,323	3,514	3,553	
36 x 60	Static	74D3660T26	1,226	1,465	1,498	
	Ratchet	74D3660T26RA	1,764	2,002	2,035	
	Crank	74D3660T26CR	1,923	2,162	2,195	
	Count Bal	74D3660T26BL	3,040	3,279	3,311	
	Electric	74D3660T26EH	3,442	3,681	3,713	
36 x 72	Static	74D3672T26	1,346	1,633	1,658	
	Ratchet	74D3672T26RA	1,823	2,110	2,135	
	Crank	74D3672T26CR	2,043	2,330	2,355	
	Count Bal	74D3672T26BL	3,174	3,460	3,504	
	Electric	74D3672T26EH	3,562	3,848	3,874	
36 x 84	Static	74D3684T26	1,590	1,925	1,943	
	Electric	74D3684T26EH	3,806	4,140	4,159	
36 x 90 *	Static	74D3690T26	1,650	2,008	2,023	
	Electric	74D3690T26EH	3,866	4,224	4,239	
36 x 96 *	Static	74D3696T26	1,710	2,092	2,103	
	Electric	74D3696T26EH	3,925	4,308	4,319	

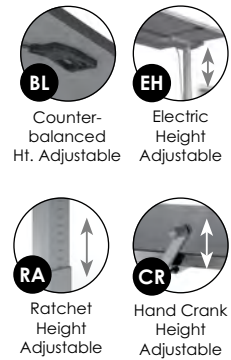

* \$200 NET surcharge per order for oversized pallet

For VertiGo table options, please reference pages 176-177.

D-shaped with TT-bases	Top Size	Base	Model Number	3P	3K	3W
	42 x 60	Static	74D4260TT32	\$2,528	\$2,969	\$2,861
		Electric	74D4260TT32EH	6,796	7,238	7,130
	42 x 72	Static	74D4272TT32	2,528	2,969	2,889
		Electric	74D4272TT32EH	6,796	7,238	7,158
	42 x 84	Static	74D4284TT32	2,612	3,054	3,003
		Electric	74D4284TT32EH	6,881	7,323	7,272
	42 x 90 *	Static	74D4290TT32	2,692	3,165	3,105
		Electric	74D4290TT32EH	6,961	7,434	7,373
	42 x 96 *	Static	74D4296TT32	2,770	3,275	3,206
		Electric	74D4296TT32EH	7,039	7,544	7,474
	48 x 60	Static	74D4860TT36	2,549	2,995	2,894
		Electric	74D4860TT36EH	9,545	9,991	9,891
48 x 72	Static	74D4872TT36	2,549	2,995	2,923	
	Electric	74D4872TT36EH	9,545	9,991	9,919	
48 x 84	Static	74D4884TT36	2,634	3,080	3,037	
	Electric	74D4884TT36EH	9,630	10,076	10,033	
48 x 90 *	Static	74D4890TT36	2,713	3,191	3,139	
	Electric	74D4890TT36EH	9,710	10,187	10,135	
48 x 96 *	Static	74D4896TT36	2,793	3,303	3,241	
	Electric	74D4896TT36EH	9,789	10,299	10,237	





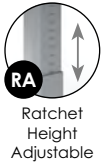

Half Round with T-bases	Top Size	Base	Model Number	3P	3K	3W
	24 x 48	Static	74HR2448T18	\$ 913	\$ 1,042	\$ 1,093
		Nesting	74HR2448T18NE	1,733	1,862	1,913
		Ratchet	74HR2448T18RA	1,449	1,578	1,629
		Electric	74HR2448T18EH	3,134	3,263	3,314
	30 x 60	Static	74HR3060T22	1,109	1,309	1,344
		Nesting	74HR3060T22NE	1,929	2,129	2,164
		Ratchet	74HR3060T22RA	1,646	1,845	1,880
		Count Bal	74HR3060T22BL	2,921	3,121	3,156
		Electric	74HR3060T22EH	3,326	3,526	3,561
	36 x 72	Static	74HR3672T26	1,344	1,630	1,638
		Nesting	74HR3672T26NE	2,304	2,590	2,598
		Ratchet	74HR3672T26RA	1,882	2,168	2,175
Count Bal		74HR3672T26BL	3,172	3,458	3,465	
Electric		74HR3672T26EH	3,560	3,846	3,853	



* \$200 NET surcharge per order for oversized pallet

For VertiGo table options, please reference pages 176-177.

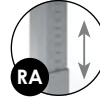
Top Size	Base	Model Number	3P	3K	3W	Trapezoid with T-bases
24 x 48	Static	74TZ2448T18	\$ 902	\$1,027	\$1,081	      
	Ratchet	74TZ2448T18RA	1,439	1,563	1,617	
	Crank	74TZ2448T18CR	1,604	1,729	1,783	
	Electric	74TZ2448T18EH	3,124	3,248	3,302	
24 x 72	Static	74TZ2472T18	1,105	1,310	1,378	
	Nesting	74TZ2472T18NE	1,925	2,130	2,198	
	Ratchet	74TZ2472T18RA	1,641	1,846	1,914	
	Crank	74TZ2472T18CR	1,807	2,012	2,080	
	Count Bal	74TZ2472T18BL	2,936	3,141	3,209	
	Electric	74TZ2472T18EH	3,326	3,531	3,599	
30 x 60	Static	74TZ3060T22	1,057	1,235	1,286	
	Nesting	74TZ3060T22NE	1,877	2,055	2,106	
	Ratchet	74TZ3060T22RA	1,593	1,771	1,822	
	Crank	74TZ3060T22CR	1,755	1,934	1,985	
	Count Bal	74TZ3060T22BL	2,886	3,065	3,116	
	Electric	74TZ3060T22EH	3,273	3,452	3,503	
36 x 72	Static	74TZ3672T26	1,316	1,591	1,606	
	Nesting	74TZ3672T26NE	2,276	2,551	2,566	
	Ratchet	74TZ3672T26RA	1,853	2,128	2,144	
	Crank	74TZ3672T26CR	2,013	2,288	2,303	
	Count Bal	74TZ3672T26BL	3,144	3,419	3,434	
	Electric	74TZ3672T26EH	3,532	3,806	3,822	

Top Size	Base	Model Number	3P	3K	3W	Squire with X-base
24 x 24	Static	74SL24X22	\$ 1,007	\$ 1,146	\$ 1,157	    
	Ratchet	74SL24X22RA	1,205	1,344	1,354	
	Short Bal	74SL24X22BLS	1,493	1,633	1,643	
30 x 30	Static	74SL30X26	1,087	1,250	1,271	
	Ratchet	74SL30X26RA	1,284	1,447	1,468	
	Short Bal	74SL30X26BLS	1,569	1,732	1,754	
36 x 36	Static	74SL36X32	1,173	1,362	1,392	
	Short Bal	74SL36X32BLS	1,654	1,844	1,874	
	Count Bal	74SL36X32BL	1,654	1,844	1,874	
42 x 42	Static	74SL42X36	1,265	1,484	1,521	
	Short Bal	74SL42X36BLS	1,743	1,962	1,999	
	Count Bal	74SL42X36BL	1,743	1,962	1,999	

For VertiGo table options, please reference pages 176-177.

tablex

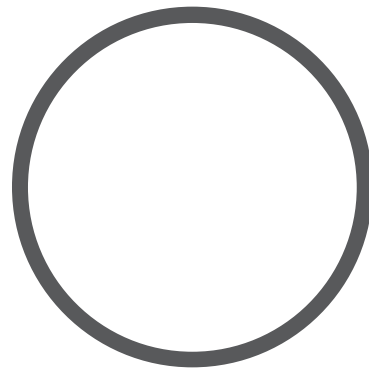

99 surge
price list
Effective October 1, 2023





Surge series tables are sleek, stylish, and versatile. With height adjustable options and a variety of top shapes and sizes, Surge provides a sophisticated solution for any space.

Surge Base Styles

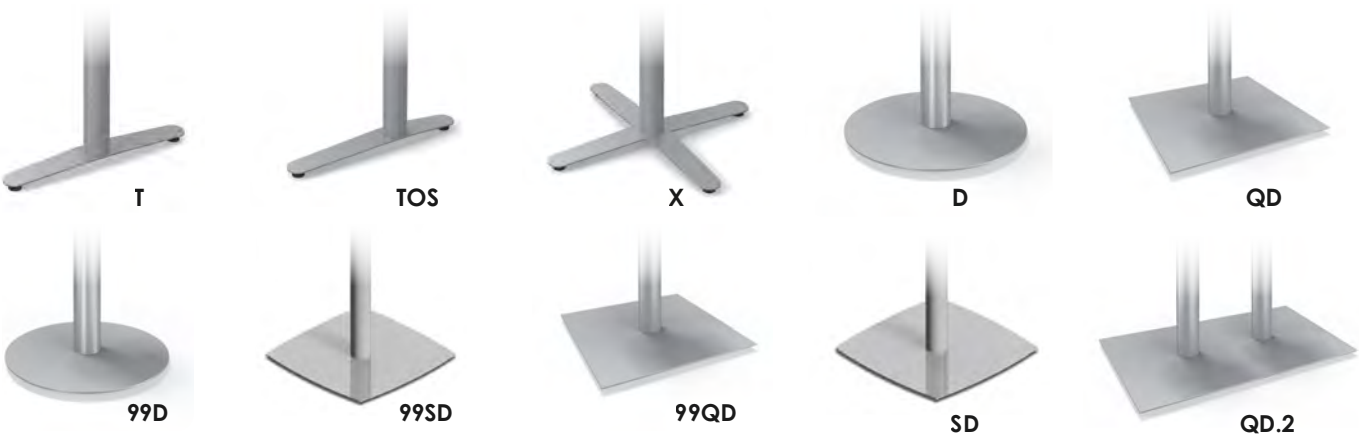

Surge Options

Standard Glides



Locking Casters



- LC Locking Casters**
can be added to any table for \$111 per set of four.
- FD Folding Bases**
priced accordingly with standard glides.
- NE Nesting Tables**
priced accordingly with locking casters.
- FT Flip Tops**
available on disc and X-based tables for \$138. Not available on counterbalanced tables.

- OS Offset T-bases**
available for \$39 per table.
- CH Chrome Finish**
is not available on Surge tables.
- WM Wire Management**
Built-in wire management is not available on Surge tables.
- WMLC Wire Management Leg Covers**
snap onto any round column and are \$50 each for 2" and \$79 each for 3".

- SH Special Height**
can be added to any table:
+ \$72 per column for heights > 29"
+ \$39 per column for heights < 29"
Special height tables with tops larger than 36x72" must be custom quoted.
- FR Footring**
is not available on Surge tables.
- PB Powerbox Mounting Plate**
is available on disc and X-bases for \$100.

Surge Height Adjustable Options

EH Electric Height is available on T-bases and is available in two finishes:

- 37 Satin Silver
- 57 Jet

BL Counterbalanced and Short Balanced are available on disc and X-bases. Available height adjustable finishes can be found on page 9.

Surge Top Shapes



Rectangle p.200



Boat p.203



Racetrack p.204



Elliptical p.205



Squircle p.206



Square p.206



Round p.207



D-shaped p.208



Half Round p.210



Trapezoid p.210

Surge Top Options

QG Quick-Connect Ganging Brackets can be added to any table for \$45 (includes 4 connectors per table).

RC 3" Radius Corners can be added to any table for \$61.

GR Grommets can be added to any table for \$45 each. To see specific locations, see page 227.

Surge Edge Options

(corresponds with 3 columns of pricing)

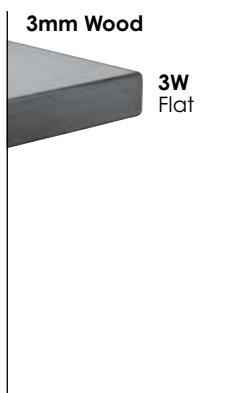
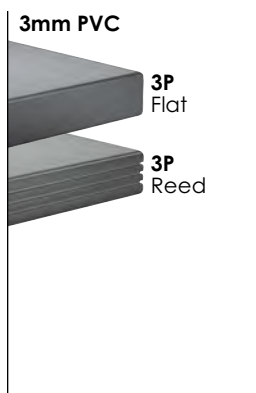

Electric Height Adjustable T-bases

Electric height adjustability gives you the ability to go from sitting to standing height at the push of a button. With a weight capacity of 225 lbs. per table, Surge is strong enough to work in many different applications.

The standard memory keypad will remember your four favorite heights.

Want to use Surge on the go? Simply add 2" to each vertical measurement to account for locking casters.

To specify:
All available electric models are priced in the following pages. They are denoted by the "EH" at the end of the model number.

Example:
99TC2460T22EH-3P
24x60" **electric height** table

\$2,539 List Price



Standard Memory Keypad

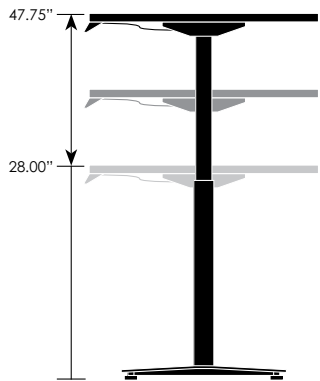

T-bases

Counterbalanced & Short Balanced Height Adjustable Disc & X-bases

Counterbalanced tables go from seated-to-standing height, while the short balanced goes from coffee-to-seated height. Available on tables using single column disc or X-bases, these tables are easy to adjust. Simply squeeze the small handle underneath and gently move the top to your desired height. It's that easy.

Want to use Surge on the go? Simply add 2" to each vertical measurement to account for the added height of locking casters.

To specify:
All available counterbalanced models are priced in the following pages. They are denoted by the "BL" or "BLS" (for short balanced) at the end of the model number.

Example:
99RD36X30BL-3P
36" round **counterbalanced** table
\$1,915 List Price

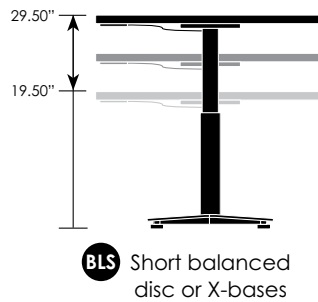
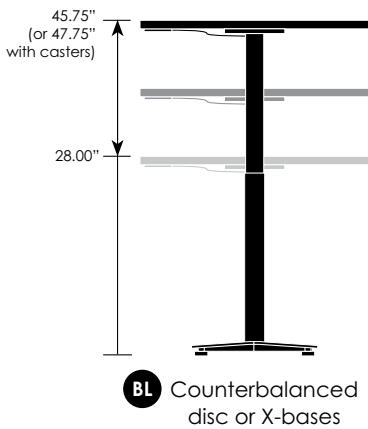
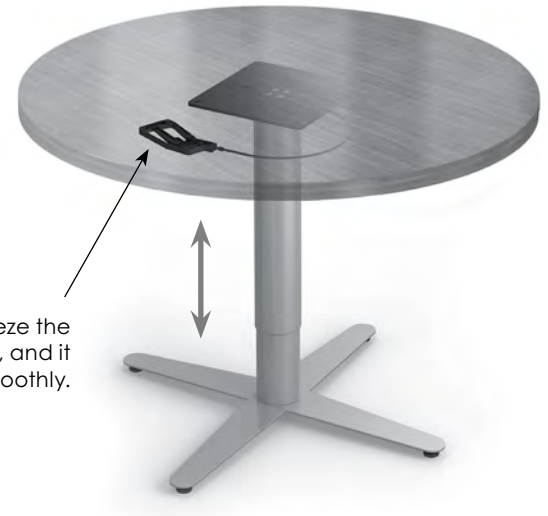

Counterbalanced Height Ranges:

Smaller Surge tables using smaller bases have a 17.75" range, while the larger tables using larger bases have an extended range of 19.75". See the list below for ranges of used on specific top shapes and sizes. All counterbalanced tables have a starting height of 28".

Square	Range	Max Ht.	Round	Range	Max Ht.
36" SQ 42" SQ	19.75"	47.75"	36" RD-X 36" BU	17.75"	45.75"
			36" RD-D 42" RD 48" RD	19.75"	47.75"

Rectangular with T-bases	Top Size	Base	Model Number	3P	3K	3W
  <div style="display: flex; justify-content: space-around; margin-top: 20px;"> <div style="text-align: center;">  <p>FD Folding T</p> </div> <div style="text-align: center;">  <p>NE Nesting T</p> </div> <div style="text-align: center;">  <p>EH Electric Height Adjustable</p> </div> </div>	24 x 36	Static	99TC2436T22	\$ 843	\$ 915	\$ 1,005
		Nesting	99TC2436T22NE	1,663	1,735	1,825
		Electric	99TC2436T22EH	2,454	2,526	2,615
	24 x 48	Static	99TC2448T22	902	997	1,098
		Folding	99TC2448T22FD	1,217	1,313	1,414
		Nesting	99TC2448T22NE	1,722	1,817	1,918
		Electric	99TC2448T22EH	2,512	2,608	2,709
	24 x 60	Static	99TC2460T22	929	1,035	1,157
		Folding	99TC2460T22FD	1,257	1,364	1,485
		Nesting	99TC2460T22NE	1,749	1,855	1,977
		Electric	99TC2460T22EH	2,539	2,646	2,767
	24 x 72	Static	99TC2472T22	979	1,106	1,241
Folding		99TC2472T22FD	1,308	1,435	1,569	
Nesting		99TC2472T22NE	2,040	2,167	2,302	
Electric		99TC2472T22EH	2,590	2,717	2,851	
24 x 84	Static	99TC2484T22	1,162	1,328	1,462	
	Folding	99TC2484T22FD	1,406	1,572	1,706	
	Nesting	99TC2484T22NE	2,138	2,304	2,438	
24 x 90 *	Static	99TC2490T22	1,221	1,410	1,541	
	Folding	99TC2490T22FD	1,464	1,654	1,785	
	Nesting	99TC2490T22NE	2,196	2,386	2,517	
24 x 96 *	Static	99TC2496T22	1,221	1,410	1,555	
	Folding	99TC2496T22FD	1,464	1,654	1,799	
	Nesting	99TC2496T22NE	2,196	2,386	2,531	
30 x 36	Static	99TC3036T26	896	985	1,076	
	Nesting	99TC3036T26NE	1,716	1,805	1,896	
	Electric	99TC3036T26EH	2,507	2,596	2,687	
30 x 48	Static	99TC3048T26	968	1,087	1,185	
	Folding	99TC3048T26FD	1,284	1,402	1,500	
	Nesting	99TC3048T26NE	1,788	1,907	2,005	
	Electric	99TC3048T26EH	2,579	2,698	2,796	
30 x 60	Static	99TC3060T26	991	1,118	1,238	
	Folding	99TC3060T26FD	1,319	1,447	1,567	
	Nesting	99TC3060T26NE	1,811	1,938	2,058	
	Electric	99TC3060T26EH	2,602	2,729	2,849	
30 x 72	Static	99TC3072T26	1,047	1,198	1,329	
	Folding	99TC3072T26FD	1,376	1,526	1,658	
	Nesting	99TC3072T26NE	2,108	2,258	2,390	
	Electric	99TC3072T26EH	2,658	2,809	2,940	

* \$200 NET surcharge per order for oversized pallet

For Surge table options, please reference pages 196-199.

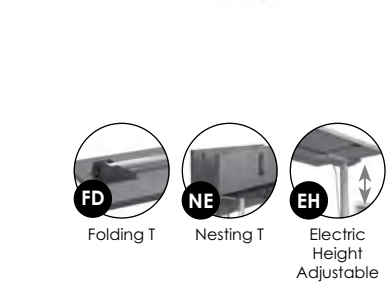
Top Size	Base	Model Number	3P	3K	3W	Rectangular with T-bases	
30 x 84	Static	99TC3084T26	\$ 1,270	\$ 1,476	\$ 1,595		
	Folding	99TC3084T26FD	1,514	1,720	1,838		
	Nesting	99TC3084T26NE	2,246	2,452	2,571		
30 x 90 *	Static	99TC3090T26	1,343	1,578	1,689		
	Folding	99TC3090T26FD	1,587	1,821	1,933		
30 x 96 *	Static	99TC3096T26	1,343	1,578	1,704		
	Folding	99TC3096T26FD	1,587	1,821	1,947		
36 x 48	Static	99TC3648T26	1,025	1,167	1,262		
	Folding	99TC3648T26FD	1,341	1,482	1,578		
	Nesting	99TC3648T26NE	1,985	2,127	2,222		
	Electric	99TC3648T26EH	2,636	2,778	2,873		
36 x 60	Static	99TC3660T26	1,112	1,288	1,386		
	Folding	99TC3660T26FD	1,440	1,616	1,714		
	Nesting	99TC3660T26NE	2,146	2,322	2,420		
	Electric	99TC3660T26EH	2,723	2,899	2,997		
36 x 72	Static	99TC3672T26	1,166	1,364	1,475		
	Folding	99TC3672T26FD	1,495	1,693	1,803		
	Nesting	99TC3672T26NE	2,227	2,425	2,535		
	Electric	99TC3672T26EH	2,777	2,975	3,086		
36 x 84	Static	99TC3684T26	1,370	1,615	1,718		
	Folding	99TC3684T26FD	1,613	1,858	1,962		
36 x 90 *	Static	99TC3690T26	1,455	1,734	1,827		
	Folding	99TC3690T26FD	1,699	1,978	2,070		
36 x 96 *	Static	99TC3696T26	1,455	1,734	1,841		
	Folding	99TC3696T26FD	1,699	1,978	2,085		

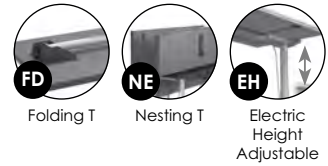

* \$200 NET surcharge per order for oversized pallet

For Surge table options, please reference pages 196-199.

Rectangular with 2 Thin Disc Bases	Top Size	Base	Model Number	3P	3K	3W
	24 x 60	Static	99TC2460D20	\$ 1,491	\$ 1,598	\$ 1,719
	24 x 72	Static	99TC2472D20	1,542	1,668	1,803
	24 x 84	Static	99TC2484D20	1,639	1,805	1,940
	24 x 90 *	Static	99TC2490D20	1,783	1,972	2,103
	24 x 96 *	Static	99TC2496D20	1,783	1,972	2,118
	30 x 60	Static	99TC3060D20	1,544	1,671	1,791
	30 x 72	Static	99TC3072D20	1,600	1,751	1,882
	30 x 84	Static	99TC3084D20	1,738	1,944	2,063
	30 x 90 *	Static	99TC3090D20	1,896	2,131	2,242
	30 x 96 *	Static	99TC3096D20	1,896	2,131	2,256
	36 x 72	Static	99TC3672D24	1,797	1,995	2,106
	36 x 84	Static	99TC3684D24	1,956	2,201	2,304
	36 x 90 *	Static	99TC3690D24	2,126	2,405	2,498
	36 x 96 *	Static	99TC3696D24	2,126	2,405	2,512
	42 x 72	Static	99TC4272D32	2,219	2,466	2,554
	42 x 84	Static	99TC4284D32	2,317	2,604	2,691
	42 x 90 *	Static	99TC4290D32	2,498	2,823	2,895
	42 x 96 *	Static	99TC4296D32	2,498	2,823	2,910

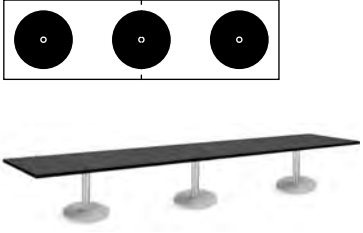

Rectangle with 2-column Disc Base	Top Size	Base	Model Number	3P	3K	3W
	24 x 36	Static	99TC2436QD2032.2	\$ 1,385	\$ 1,457	\$ 1,547
	24 x 48	Static	99TC2448QD2032.2	1,443	1,539	1,640
	30 x 36	Static	99TC3036QD2032.2	1,428	1,518	1,609
	30 x 48	Static	99TC3048QD2032.2	1,500	1,619	1,717
	36 x 48	Static	99TC3648QD2032.2	1,558	1,699	1,794

Rectangular with 3 Thin Disc Bases	Top Size	Base	Model Number	3P	3K	3W
	42 x 120	Static	99TC42120D32(3)-TJ	\$ 3,613	\$ 4,096	\$ 4,122
	42 x 144	Static	99TC42144D32(3)-TJ	3,810	4,372	4,397



* \$200 NET surcharge per order for oversized pallet

For Surge table options, please reference pages 196-199.

surge

Top Size	Base	Model Number	3P	3K	3W	Boat-shaped with T-bases
30 x 42 x 84	Static	99BT3084T26	\$ 1,770	\$ 2,159	\$ 2,126	
30 x 42 x 90 *	Static	99BT3090T26	1,908	2,352	2,292	
30 x 42 x 96 *	Static	99BT3096T26	1,908	2,352	2,306	

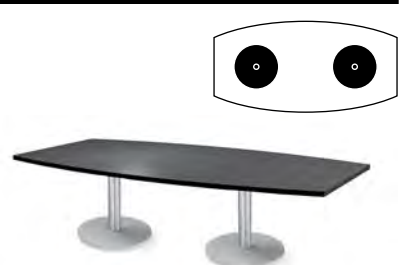
Top Size	Base	Model Number	3P	3K	3W	Boat-shaped with 2 Thin Disc Bases
30 x 42 x 84	Static	99BT3084D24	\$ 2,316	\$ 2,705	\$ 2,672	
30 x 42 x 90 *	Static	99BT3090D24	2,539	2,983	2,923	
30 x 42 x 96 *	Static	99BT3096D24	2,539	2,983	2,937	
36 x 48 x 84	Static	99BT3684D32	2,710	3,154	3,088	
36 x 48 x 90 *	Static	99BT3690D32	2,952	3,459	3,360	
36 x 48 x 96 *	Static	99BT3696D32	2,952	3,459	3,375	



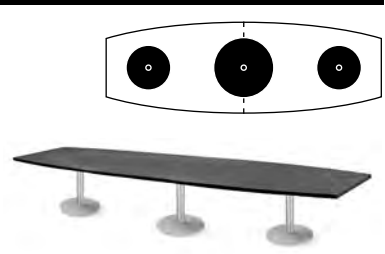

CH SH ← ⊗
 N/A +143 2 thin disc bases:

Top Size	Base	Model Number	3P	3K	3W	Boat-shaped with 3 Thin Disc Bases
36 x 48 x 120	Static	99BT36120D243224-TJ	\$ 3,925	\$ 4,635	\$ 4,456	
36 x 48 x 144	Static	99BT36144D243224-TJ	4,239	5,075	4,859	

CH SH ← ⊗
 N/A +215 3 thin disc bases:

* \$200 NET surcharge per order for oversized pallet

For Surge table options, please reference pages 196-199.

Racetrack with T-bases	Top Size	Base	Model Number	3P	3K	3W
    <p>Folding T Nesting T Electric Height Adjustable</p>	36 x 60	Static	99RT3660T26	\$ 1,390	\$ 1,678	\$ 1,655
		Nesting	99RT3660T26NE	2,350	2,638	2,615
		Electric	99RT3660T26EH	2,991	3,279	3,256
	36 x 72	Static	99RT3672T26	1,390	1,678	1,684
		Folding	99RT3672T26FD	1,719	2,006	2,012
		Nesting	99RT3672T26NE	2,424	2,712	2,718
		Electric	99RT3672T26EH	2,991	3,279	3,285
	36 x 84	Static	99RT3684T26	1,680	2,050	2,023
		Folding	99RT3684T26FD	1,964	2,334	2,307
	36 x 90 *	Static	99RT3690T26	1,855	2,278	2,226
		Folding	99RT3690T26FD	2,098	2,522	2,469
	36 x 96 *	Static	99RT3696T26	1,855	2,278	2,240
Folding		99RT3696T26FD	2,098	2,522	2,484	

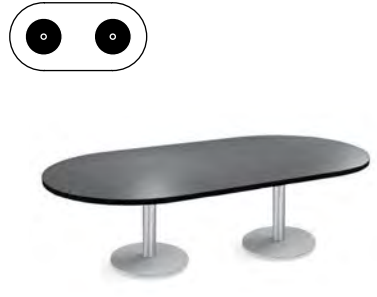
Racetrack with 2 Thin Disc Bases	Top Size	Base	Model Number	3P	3K	3W
	36 x 72	Static	99RT3672D20	\$ 1,943	\$ 2,231	\$ 2,237
	36 x 84	Static	99RT3684D20	2,188	2,558	2,531
	36 x 90 *	Static	99RT3690D20	2,408	2,831	2,779
	36 x 96 *	Static	99RT3696D20	2,408	2,831	2,793
	42 x 84	Static	99RT4284D24	2,313	2,701	2,668
	42 x 90 *	Static	99RT4290D24	2,539	2,983	2,923
	42 x 96 *	Static	99RT4296D24	2,539	2,983	2,937
	48 x 84	Static	99RT4884D32	2,867	3,374	3,261
	48 x 90 *	Static	99RT4890D32	2,952	3,459	3,360
	48 x 96 *	Static	99RT4896D32	2,952	3,459	3,375

⊗ → **CH** **SH**
2 thin disc bases: N/A +143

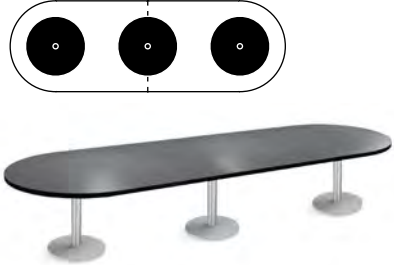
Racetrack with 3 Thin Disc Bases	Top Size	Base	Model Number	3P	3K	3W
	42 x 120	Static	99RT42120D24(3)-TJ	\$ 3,779	\$ 4,483	\$ 4,300
	42 x 144	Static	99RT42144D24(3)-TJ	4,090	4,918	4,699
	48 x 120	Static	99RT48120D32(3)-TJ	4,183	4,894	4,714
	48 x 144	Static	99RT48144D32(3)-TJ	4,497	5,334	5,117

⊗ → **CH** **SH**
3 thin disc bases: N/A +215

* \$200 NET surcharge per order for oversized pallet

For Surge table options, please reference pages 196-199.

Top Size	Base	Model Number	3P	3K	3W	Elliptical with T-bases
30 x 54	Static	99EL3054T22	\$ 1,116	\$ 1,298	\$ 1,320	
	Electric	99EL3054T22EH	2,727	2,908	2,930	
30 x 60	Static	99EL3060T22	1,164	1,365	1,384	
	Electric	99EL3060T22EH	2,775	2,975	2,994	
36 x 60	Static	99EL3660T26	1,275	1,516	1,516	
	Electric	99EL3660T26EH	2,886	3,127	3,127	
36 x 72	Static	99EL3672T26	1,390	1,678	1,665	
	Electric	99EL3672T26EH	3,001	3,289	3,276	
36 x 84	Static	99EL3684T26	1,636	1,971	1,945	
36 x 90 *	Static	99EL3690T26	1,751	2,133	2,084	
36 x 96 *	Static	99EL3696T26	1,751	2,133	2,095	



Top Size	Base	Model Number	3P	3K	3W	Elliptical with 2 Thin Disc Bases
36 x 72	Static	99EL3672D20	\$ 1,943	\$ 2,231	\$ 2,218	
36 x 84	Static	99EL3684D20	2,104	2,439	2,413	
36 x 90 *	Static	99EL3690D20	2,304	2,686	2,637	
36 x 96 *	Static	99EL3696D20	2,304	2,686	2,648	
42 x 72	Static	99EL4272D24	2,182	2,517	2,480	
42 x 84	Static	99EL4284D24	2,313	2,701	2,647	
42 x 90 *	Static	99EL4290D24	2,541	2,987	2,901	
42 x 96 *	Static	99EL4296D24	2,541	2,987	2,912	
48 x 84	Static	99EL4884D32	2,868	3,375	3,243	
48 x 90 *	Static	99EL4890D32	2,953	3,460	3,339	
48 x 96 *	Static	99EL4896D32	2,953	3,460	3,351	

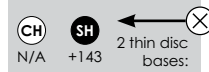

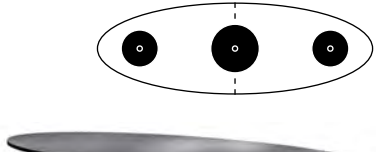

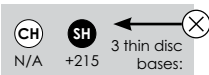
Top Size	Base	Model Number	3P	3K	3W	Elliptical with 3 Thin Disc Bases
42 x 120	Static	99EL42120D24(3)-TJ	\$ 3,779	\$ 4,483	\$ 4,259	
42 x 144	Static	99EL42144D24(3)-TJ	4,090	4,918	4,647	
48 x 120	Static	99EL48120D32(3)-TJ	4,183	4,894	4,677	
48 x 144	Static	99EL48144D32(3)-TJ	4,497	5,334	5,068	







* \$200 NET surcharge per order for oversized pallet



For Surge table options, please reference pages 196-199.



surge

Squiracle with X-base	Top Size	Base	Model Number	3P	3K	3W
   Short Balanced Ht. Adjustable Counter-balanced Ht. Adjustable	24 x 24	Static	99SL24X22	\$ 910	\$ 1,049	\$ 1,060
		Short Bal	99SL24X22BLS	1,485	1,624	1,635
	30 x 30	Static	99SL30X26	975	1,138	1,159
		Short Bal	99SL30X26BLS	1,554	1,717	1,739
	36 x 36	Static	99SL36X30	1,134	1,324	1,354
		Short Bal	99SL36X30BLS	2,044	2,234	2,264
		Count Bal	99SL36X30BL	2,044	2,234	2,264
	42 x 42	Static	99SL42X30	1,207	1,426	1,463
		Short Bal	99SL42X30BLS	2,117	2,336	2,373
		Count Bal	99SL42X30BL	2,117	2,336	2,373





Squiracle with Thin Squiracle Disc Base	Top Size	Base	Model Number	3P	3K	3W
   Short Balanced Ht. Adjustable Counter-balanced Ht. Adjustable	24 x 24	Static	99SL24SD16	\$ 1,022	\$ 1,161	\$ 1,172
		Short Bal	99SL24SD16BLS	1,671	1,810	1,821
	30 x 30	Static	99SL30SD16	1,082	1,245	1,267
		Short Bal	99SL30SD16BLS	1,731	1,894	1,916
	36 x 36	Static	99SL36SD20	1,186	1,376	1,406
		Short Bal	99SL36SD20BLS	1,838	2,028	2,058
		Count Bal	99SL36SD20BL	1,838	2,028	2,058
	42 x 42	Static	99SL42SD26	1,391	1,611	1,647
		Short Bal	99SL42SD26BLS	2,032	2,252	2,288
		Count Bal	99SL42SD26BL	2,032	2,252	2,288





 Thin disc bases:





		
N/A	+72	N/A

Square with X-base	Top Size	Base	Model Number	3P	3K	3W
   Short Balanced Ht. Adjustable Counter-balanced Ht. Adjustable	24 x 24	Static	99SQ2424X22	\$ 685	\$ 734	\$ 812
		Short Bal	99SQ2424X22BLS	1,260	1,308	1,387
	30 x 30	Static	99SQ3030X26	755	830	917
		Short Bal	99SQ3030X26BLS	1,334	1,409	1,497
	36 x 36	Static	99SQ3636X30	927	1,033	1,126
		Short Bal	99SQ3636X30BLS	1,837	1,943	2,036
		Count Bal	99SQ3636X30BL	1,837	1,943	2,036
	42 x 42	Static	99SQ4242X34	1,042	1,186	1,279
		Short Bal	99SQ4242X34BLS	1,952	2,096	2,189
		Count Bal	99SQ4242X34BL	1,952	2,096	2,189



For Surge table options, please reference pages 196-199.

Top Size	Base	Model Number	3P	3K	3W	Square with Thin Square Disc Base
24 x 24	Static	99SQ2424QD16	\$ 794	\$ 843	\$ 922	    <p>Short Balanced Ht. Adjustable</p> <p>Counter-balanced Ht. Adjustable</p> 
	Short Bal	99SQ2424QD16BLS	1,446	1,495	1,573	
30 x 30	Static	99SQ3030QD16	860	935	1,022	
	Short Bal	99SQ3030QD16BLS	1,511	1,586	1,674	
36 x 36	Static	99SQ3636QD20	978	1,085	1,178	
	Short Bal	99SQ3636QD20BLS	1,631	1,738	1,830	
	Count Bal	99SQ3636QD20BL	1,631	1,738	1,830	
42 x 42	Static	99SQ4242QD26	1,201	1,345	1,438	
	Short Bal	99SQ4242QD26BLS	1,846	1,990	2,083	
	Count Bal	99SQ4242QD26BL	1,846	1,990	2,083	

Top Size	Base	Model Number	3P	3K	3W	Round with X-base
24 x 24	Static	99RD24X22	\$ 725	\$ 790	\$ 832	    <p>Short Balanced Ht. Adjustable</p> <p>Counter-balanced Ht. Adjustable</p>
	Short Bal	99RD24X22BLS	1,300	1,365	1,407	
30 x 30	Static	99RD30X26	819	919	957	
	Short Bal	99RD30X26BLS	1,398	1,499	1,536	
36 x 36	Static	99RD36X30	1,005	1,143	1,175	
	Short Bal	99RD36X30BLS	1,915	2,053	2,085	
	Count Bal	99RD36X30BL	1,915	2,053	2,085	
42 x 42	Static	99RD42X30	1,129	1,317	1,334	
	Short Bal	99RD42X30BLS	2,039	2,227	2,244	
	Count Bal	99RD42X30BL	2,039	2,227	2,244	
48 x 48	Static	99RD48X34	1,186	1,388	1,417	
	Short Bal	99RD48X34BLS	2,096	2,298	2,327	
	Count Bal	99RD48X34BL	2,096	2,298	2,327	



Top Size	Base	Model Number	3P	3K	3W	Round with thin Disc Base
24 x 24	Static	99RD24D20	\$ 835	\$ 900	\$ 941	    <p>Short Balanced Ht. Adjustable</p> <p>Counter-balanced Ht. Adjustable</p> 
	Short Bal	99RD24D20BLS	1,429	1,494	1,535	
30 x 30	Static	99RD30D20	924	1,025	1,062	
	Short Bal	99RD30D20BLS	1,518	1,618	1,656	
36 x 36	Static	99RD36D20	1,018	1,156	1,188	
	Short Bal	99RD36D20BLS	1,612	1,750	1,782	
	Count Bal	99RD36D20BL	1,612	1,750	1,782	
42 x 42	Static	99RD42D24	1,181	1,369	1,386	
	Short Bal	99RD42D24BLS	2,078	2,266	2,283	
	Count Bal	99RD42D24BL	2,078	2,266	2,283	
48 x 48	Static	99RD48D32	1,345	1,547	1,576	
	Short Bal	99RD48D32BLS	2,236	2,438	2,467	
	Count Bal	99RD48D32BL	2,236	2,438	2,467	



For Surge table options, please reference pages 196-199.



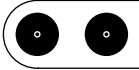

D-shaped with T-bases	Top Size	Base	Model Number	3P	3K	3W
 	24 x 36	Static	99D2436T22	\$ 901	\$ 997	\$ 1,057
		Electric	99D2436T22EH	2,512	2,607	2,667
	24 x 48	Static	99D2448T22	981	1,108	1,173
		Electric	99D2448T22EH	2,591	2,719	2,783
	24 x 60	Static	99D2460T22	1,061	1,220	1,289
		Electric	99D2460T22EH	2,671	2,830	2,900
	24 x 72	Static	99D2472T22	1,140	1,331	1,406
		Electric	99D2472T22EH	2,751	2,942	3,016
 EH Electric Height Adjustable	24 x 84	Static	99D2484T22	1,305	1,528	1,607
		24 x 90 *	Static	99D2490T22	1,345	1,584
	24 x 96 *	Static	99D2496T22	1,384	1,639	1,723
	30 x 48	Static	99D3048T26	1,070	1,229	1,281
		Electric	99D3048T26EH	2,681	2,840	2,892
	30 x 60	Static	99D3060T26	1,170	1,369	1,420
		Electric	99D3060T26EH	2,781	2,980	3,030
	30 x 72	Static	99D3072T26	1,269	1,508	1,558
		Electric	99D3072T26EH	2,880	3,119	3,169
	30 x 84	Static	99D3084T26	1,454	1,732	1,781
	30 x 90 *	Static	99D3090T26	1,503	1,802	1,850
	30 x 96 *	Static	99D3096T26	1,553	1,872	1,919
	36 x 48	Static	99D3648T26	1,149	1,341	1,380
		Electric	99D3648T26EH	2,760	2,952	2,991
	36 x 60	Static	99D3660T26	1,269	1,508	1,540
		Electric	99D3660T26EH	2,880	3,119	3,151
	36 x 72	Static	99D3672T26	1,388	1,675	1,700
		Electric	99D3672T26EH	2,999	3,286	3,311
	36 x 84	Static	99D3684T26	1,593	1,927	1,945
	36 x 90 *	Static	99D3690T26	1,653	2,011	2,026
	36 x 96 *	Static	99D3696T26	1,712	2,095	2,106

* \$200 NET surcharge per order for oversized pallet

For Surge table options, please reference pages 196-199.

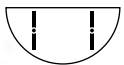
Top Size	Base	Model Number	3P	3K	3W	D-shaped with 2 Disc Bases
24 x 60	Static	99D2460D20	\$ 1,623	\$ 1,782	\$ 1,852	 
24 x 72	Static	99D2472D20	1,702	1,894	1,968	
24 x 84	Static	99D2484D20	1,867	2,090	2,169	
24 x 90 *	Static	99D2490D20	1,907	2,146	2,227	
24 x 96 *	Static	99D2496D20	1,947	2,202	2,286	
30 x 60	Static	99D3060D20	1,723	1,922	1,973	
30 x 72	Static	99D3072D20	1,822	2,061	2,111	
30 x 84	Static	99D3084D20	2,007	2,285	2,334	
30 x 90 *	Static	99D3090D20	2,056	2,355	2,403	
30 x 96 *	Static	99D3096D20	2,106	2,425	2,472	
36 x 72	Static	99D3672D24	2,019	2,306	2,331	
36 x 84	Static	99D3684D24	2,264	2,598	2,616	
36 x 90 *	Static	99D3690D24	2,324	2,682	2,697	
36 x 96 *	Static	99D3696D24	2,383	2,766	2,777	
42 x 72	Static	99D4272D32	2,704	3,145	3,066	
42 x 84	Static	99D4284D32	2,789	3,230	3,180	
42 x 90 *	Static	99D4290D32	2,868	3,341	3,281	
42 x 96 *	Static	99D4296D32	2,947	3,451	3,382	

 N/A
 +143
 2 disc bases:

Top Size	Base	Model Number	3P	3K	3W	Half Round with T-bases
30 x 60	Static	99HR3060T22	\$ 1,162	\$ 1,362	\$ 1,397	   Nesting T  Electric Height Adjustable
	Nesting	99HR3060T22NE	1,982	2,182	2,217	
	Electric	99HR3060T22EH	2,772	2,972	3,007	
36 x 72	Static	99HR3672T26	1,387	1,673	1,680	
	Nesting	99HR3672T26NE	2,347	2,633	2,640	
	Electric	99HR3672T26EH	2,998	3,284	3,291	

* \$200 NET surcharge per order for oversized pallet

For Surge table options, please reference pages 196-199.

Trapezoid with T-bases	Top Size	Base	Model Number	3P	3K	3W
	30 x 60	Static	99TZ3060T22	\$ 1,109	\$ 1,288	\$ 1,339
		Nesting	99TZ3060T22NE	1,929	2,108	2,158
		Electric	99TZ3060T22EH	2,720	2,898	2,949
	36 x 72	Static	99TZ3672T26	1,359	1,633	1,649
		Nesting	99TZ3672T26NE	2,319	2,593	2,609
		Electric	99TZ3672T26EH	2,960	3,235	3,250

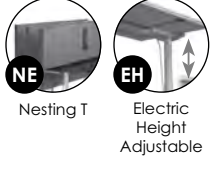

For Surge table options, please reference pages 196-199.





For Surge table options, please reference pages 196-199.

tablex

AC accessories
price list

Effective October 1, 2023



Laminate Modesty Panels	Top Size	Base	Model Number	Hardware	3P	3W
	10 x 36	Static	MP1036	02 Black	163	283
		Nesting	MP1036NE	02 Black	254	373
 Static	10 x 48	Static	MP1048	02 Black	192	343
		Nesting	MP1048NE	02 Black	282	434
	10 x 60	Static	MP1060	02 Black	220	403
Folding		MP1060FD	02 Black	381	564	
Nesting		MP1060NE	02 Black	311	494	
 Folding	10 x 72	Static	MP1072	02 Black	264	478
		Folding	MP1072FD	02 Black	410	624
	Nesting	MP1072NE	02 Black	339	554	
10 x 84	Static	MP1084	02 Black	292	538	
	Folding	MP1084FD	02 Black	533	779	
	Nesting	MP1084NE	02 Black	428	674	
 Nesting	10 x 90	Static	MP1090	02 Black	336	599
		Folding	MP1090FD	02 Black	562	825
	Nesting	MP1090NE	02 Black	457	720	
10 x 96 *	Static	MP1096	02 Black	336	613	
	Folding	MP1096FD	02 Black	562	840	
	Nesting	MP1096NE	02 Black	457	734	

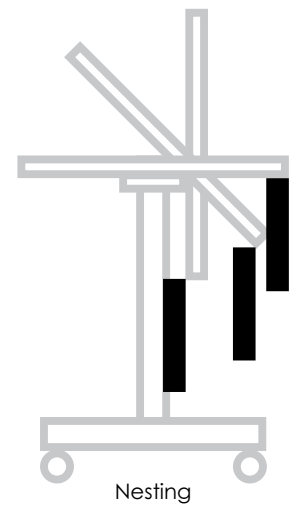
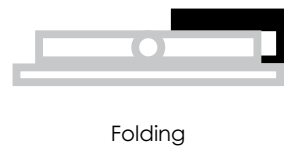

accessories

* \$200 NET surcharge per order for oversized pallet

Top Size	Base	Model Number	Hardware		Price	Frosted Acrylic Modesty Panels
10 x 36	Static or Nesting	MAP1036	-BL	-SV	400	
10 x 48	Static or Nesting	MAP1048	-BL	-SV	445	
10 x 60	Static or Nesting	MAP1060	-BL	-SV	490	
10 x 66	Static or Nesting	MAP1066	-BL	-SV	513	
10 x 72	Static or Nesting	MAP1072	-BL	-SV	535	
10 x 84	Static or Nesting	MAP1084	-BL	-SV	687	
10 x 90	Static or Nesting	MAP1090	-BL	-SV	733	
10 x 96 *	Static or Nesting	MAP1096	-BL	-SV	733	

Top Size	Basez	Model Number	Finish	Price	Perforated Metal Modesty Panels
9 x 48	Static or Nesting	MMP948	Powdercoated	547	
9 x 60	Static or Nesting	MMP960	Powdercoated	579	
9 x 72	Static or Nesting	MMP972	Powdercoated	611	

Top Size	Base	Model Number	Color	Price	Mesh Modesty Panels
10 x 36	Static or Nesting	MSP1036	Black mesh	286	
10 x 48	Static or Nesting	MSP1048	Black mesh	298	
10 x 60	Static or Nesting	MSP1060	Black mesh	313	
10 x 72	Static or Nesting	MSP1072	Black mesh	327	
10 x 84	Static or Nesting	MSP1084	Black mesh	342	
10 x 90	Static or Nesting	MSP1090	Black mesh	347	
10 x 96 *	Static or Nesting	MSP1096	Black mesh	354	

* \$200 NET surcharge per order for oversized pallet

Laminate Privacy Panels	Top Size	Base	Model Number	Hardware	3P	3W
	10 x 36	Static	PP1036	Silver	\$ 291	\$ 410
	10 x 48	Static	PP1048	Silver	317	469
	10 x 60	Static	PP1060	Silver	346	529
	10 x 72	Static	PP1072	Silver	375	589
	10 x 84	Static	PP1084	Silver	481	727
	10 x 90	Static	PP1090	Silver	509	773
	10 x 96 *	Static	PP1096	Silver	509	787

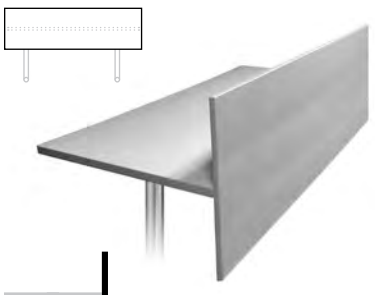
Extended Laminate Privacy Panels	Top Size	Base	Model Number	Hardware	3P	3W
	22 x 36	Static	EPP2236	02 Black	\$ 416	\$ 573
	22 x 48	Static	EPP2248	02 Black	469	660
	22 x 60	Static	EPP2260	02 Black	523	748
	22 x 72	Static	EPP2272	02 Black	658	925
	22 x 84	Static	EPP2284	02 Black	863	1,170
	22 x 90	Static	EPP2290	02 Black	876	1,199
	22 x 96 *	Static	EPP2296	02 Black	889	1,227

* \$200 NET surcharge per order for oversized pallet

Top Size	Base	Model Number	Hardware	Price	Frosted Acrylic Privacy Panels
10 x 36	Static	PAP1036	Silver	\$ 327	
10 x 48	Static	PAP1048	Silver	368	
10 x 60	Static	PAP1060	Silver	409	
10 x 72	Static	PAP1072	Silver	450	
10 x 84	Static	PAP1084	Silver	569	
10 x 90	Static	PAP1090	Silver	610	
10 x 96 *	Static	PAP1096	Silver	610	

Top Size	Base	Model Number	Hardware	Price	Extended Acrylic Privacy Panels
22 x 36	Static	EPAP2236	Chrome	\$ 486	
22 x 48	Static	EPAP2248	Chrome	563	
22 x 60	Static	EPAP2260	Chrome	640	
22 x 72	Static	EPAP2272	Chrome	717	
22 x 84	Static	EPAP2284	Chrome	892	
22 x 90	Static	EPAP2290	Chrome	930	
22 x 96 *	Static	EPAP2296	Chrome	969	

* \$200 NET surcharge per order for oversized pallet

Metal Pop-up Units

Each of our metal pop-up units feature a single touch door opening which closes when not in use. These units are available in a multitude of configurations balancing your need for conventional (15 amp/125 volt) power with USB power and data jacks. **When ordering electrical components on pages 218-225, it is the responsibility of the customer to ensure the components selected meet local electrical codes.**

Finishes: Choose between Black and Anodized Aluminum.

Cord: Choose between 72" and 120" length. All feature 15 amp/125 volt. Some units require two cords.

Cutout: You do not need to specify a grommet or add any upcharge to your table price. The cost of the cutout is included in the price of the unit.

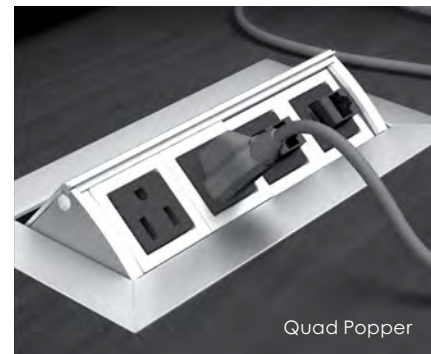

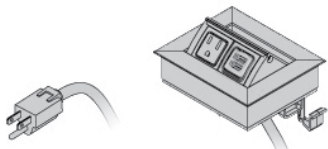
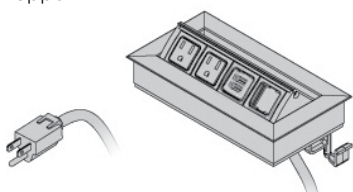
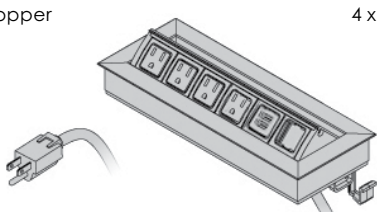
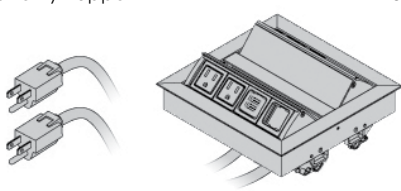
Product	Approx. Size	Configuration	Cord	Model Number	BL	AA
 Twin Popper	4 x 5"	2 Power	72"	PD04-2P-72	283	N/A
			120"	PD04-2P-120	294	N/A
		1 Power + 1 KO	72"	PD04-1P-1D-72	269	N/A
			120"	PD04-1P-1D-120	281	N/A
		1 Power + 2 USB	72"	PD04-1P-2U-72	378	N/A
			120"	PD04-1P-2U-120	390	N/A
 Quad Popper	4 x 8"	4 Power	72"	PD06-4P-72	659	516
			120"	PD06-4P-120	670	527
		2 Power + 2 KO	72"	PD06-2P-2D-72	523	411
			120"	PD06-2P-2D-120	535	424
		2 Power + 2 USB + 1 KO	72"	PD06-2P-2U-72	633	521
			120"	PD06-2P-2U-120	645	533
 Hex Popper	4 x 11"	6 Power	72"	PD14-6P-72	784	615
			120"	PD14-6P-120	796	626
		3 Power + 3 KO	72"	PD14-3P-3D-72	584	460
			120"	PD14-3P-3D-120	596	472
		4 Power + 2 USB + 1 KO	72"	PD14-4P-2U-72	813	662
			120"	PD14-4P-2U-120	825	674
 Butterfly Popper	8 x 8"	8 Power	72"	PD08-8P-72	1,224	951
			120"	PD08-8P-120	1,247	974
		4 Power + 4 KO	72"	PD08-4P-4D-72	1,044	811
			120"	PD08-4P-4D-120	1,067	834
		4 Power + 4 USB + 2 KO	72"	PD08-4P-4U-72	1,264	1,031
			120"	PD08-4P-4U-120	1,287	1,054

Where would you like your power units?

For custom locations, please provide a drawing with your order.

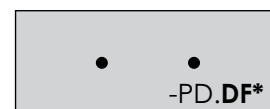
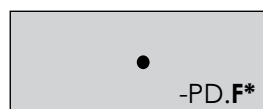
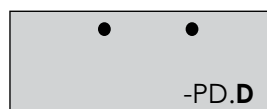
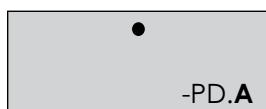

***NOTE:** Locations -PD.F & -PD.DF are NOT available on hand crank or nesting tables.

Plastic Units

These units are designed with an eye on the fixed budget. They are available in a multitude of configurations balancing your need for conventional (15 amp/125 volt) power with USB power and data jacks.

Finishes: Choose between Black and White. Other finishes are available for those units marked with "#". Contact TableX customer service for options and pricing.

Cord: Choose between 72" and 120" length. All feature 15 amp/125 volt.

Cutout: You do not need to specify a grommet or add any upcharge to your table price. The cost of the cutout is included in the price of the unit.



Product	Approx. Size	Configuration	Cord	Model Number	Color	List
	3.75" round	3 Power	72"	PD17-3P-72	-BL -WH -#	199
			120"	PD17-3P-120	-BL -WH -#	210
		2 Power + 1 USB	72"	PD17-2P-1U-72	-BL -WH -#	287
			120"	PD17-2P-1U-120	-BL -WH -#	299
	5" round	3 Power	72"	PD16-3P-72	-BL -WH	265
			120"	PD16-3P-120	-BL -WH	278
		2 Power + 1 USB	72"	PD16-2P-1U-72	-BL -WH	365
			120"	PD16-2P-1U-120	-BL -WH	375
	2.75 x 7.313 x 2.063"	4 Power	72"	PD18-CO-4P-72	-BL -WH	333
			120"	PD18-CO-4P-120	-BL -WH	345
		2 Power + 2 USB	72"	PD18-CO-2P-2U-72	-BL -WH	408
		+ 1 KO	120"	PD18-CO-2P-2U-120	-BL -WH	419
	3.75 x 7.625 x 1.75"	2 Power + 1 Dual USB-A+C Port + Qi Wireless Charger	108"	PD19-108	-BL -WH	336

Additional Outlet Options	Description	Model Number	List
HDMI	- Fits into blank data knockouts with 18" cord	B-HDMI	122
RJ45/Cat 6	- Fits into blank data knockouts with 120" cord	B-RJ45	130

p 218-219: Unless specified on order, all USB configurations will be an A+C USB Dual Port.

Villa™ Daisylink™ System

The Villa Daisylink system is a 4 wire, 2 circuit hardwire system which allows for non-sequential plug and play use. Link up to 20 single kits or 10 double kits in a row using one of three power infeed options.

Grommet holes are pre-routed in the top, and each unit comes with a flush grommet cover.

3 finishes available:

- BL: Black grommet, black body
- SV: Silver grommet, silver body
- WH: White grommet, black body

Infeeds: You must specify a power infeed unit for each row or grouping of tables. The number of kits that can be supported per row varies depending on the infeed specified.



- Single Kit includes:**
- 1 Villa power base
 - 1 FM cable
 - 1 FF cable
 - 4 cable clamps
 - 1 grommet (on -L / -F models)







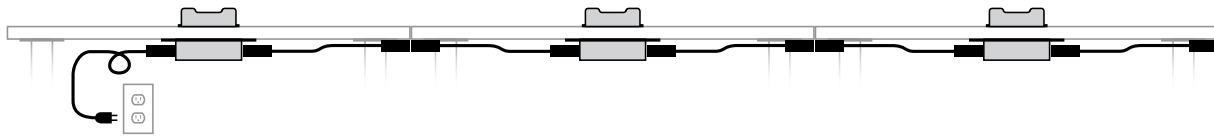

- Double Kit includes:**
- 2 Villa power bases
 - 1 FM cable
 - 2 FF cable
 - 6 cable clamps
 - 2 grommets (on -L / -F models)

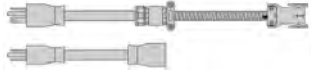
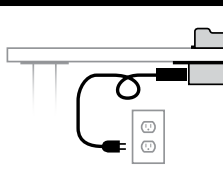

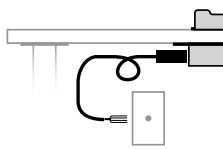

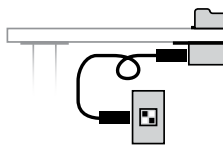

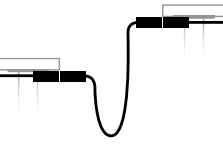
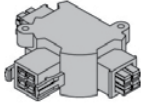
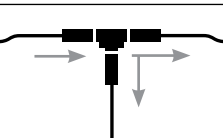



How Does the Villa Daisylink System Work?

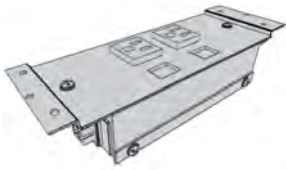

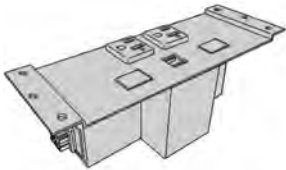

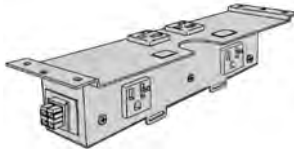
Daisylink Accessories	Description	Visual	Cord	Model Number	Price
20/15 AMP Plug Infeed 	- 20 AMP outlet with standard 15 AMP adapter can be plugged into any standard wall outlet. - Feeds up to 10 units. - 20 total receptacles		72	VAP-72	\$231
Hardwire Infeed 	- 2 circuit system hardwired into wall and plugs into first table in the row. - Feeds up to 20 units.		72	VHW-72	184
Quick Disconnect Kit 	- Hardwired wall unit paired with an FF jumper unit which plugs into first table in the row. - Feeds up to 20 units.		72	VQD-72	307
FM Jumper Unit 	- Great for linking tables around a corner, face to face, bypassing a non-powered table, or two tables that are not in perfect alignment.		12 24 36 48 60 72	VFM-12 VFM-24 VFM-36 VFM-48 VFM-60 VFM-72	100 118 136 155 172 191
Splitter 	- Splits power to feed tables running in different directions			VT-MFM	159

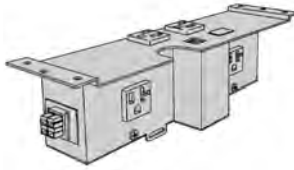
accessories

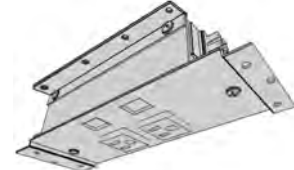
Single Villa Kits	Double Villa Kits
-------------------	-------------------

Villa Daisylink Kits	Grommet Cover	Table Size	Model No.	List	Model No.	List
		36"	V36SP-2P	466	N/A	N/A
		48"	V48SP-2P	466	N/A	N/A
		60"	V60SP-2P	466	V60DP-2P	850
		72"	V72SP-2P	466	V72DP-2P	850
		84"	V84SP-2P	N/A	V84DP-2P	850
		90"	V90SP-2P	N/A	V90DP-2P	N/A
		96"	V96SP-2P	N/A	V96DP-2P	850
		36"	V36SP-2P-1U	617	N/A	N/A
		48"	V48SP-2P-1U	617	N/A	N/A
		60"	V60SP-2P-1U	617	V60DP-2P-1U	1,153
		72"	V72SP-2P-1U	617	V72DP-2P-1U	1,153
		84"	V84SP-2P-1U	N/A	V84DP-2P-1U	1,153
		90"	V90SP-2P-1U	N/A	V90DP-2P-1U	N/A
		96"	V96SP-2P-1U	N/A	V96DP-2P-1U	1,153
		36"	V36SP-2P-2C	541	N/A	N/A
		48"	V48SP-2P-2C	541	N/A	N/A
		60"	V60SP-2P-2C	541	V60DP-2P-2C	903
		72"	V72SP-2P-2C	541	V72DP-2P-2C	903
		84"	V84SP-2P-2C	N/A	V84DP-2P-2C	903
		90"	V90SP-2P-2C	N/A	V90DP-2P-2C	N/A
		96"	V96SP-2P-2C	N/A	V96DP-2P-2C	903
		36"	V36SP-2P-1U-2C	692	N/A	N/A
		48"	V48SP-2P-1U-2C	692	N/A	N/A
		60"	V60SP-2P-1U-2C	692	V60DP-2P-1U-2C	1,206
		72"	V72SP-2P-1U-2C	692	V72DP-2P-1U-2C	1,206
		84"	V84SP-2P-1U-2C	N/A	V84DP-2P-1U-2C	1,206
		90"	V90SP-2P-1U-2C	N/A	V90DP-2P-1U-2C	N/A
		96"	V96SP-2P-1U-2C	N/A	V96DP-2P-1U-2C	1,206
	None	36"	V36SP-2C	525	N/A	N/A
		48"	V48SP-2C	525	N/A	N/A
		60"	V60SP-2C	525	V60DP-2C	697
		72"	V72SP-2C	525	V72DP-2C	697
		84"	V84SP-2C	525	V84DP-2C	697
		90"	V90SP-2C	N/A	V90DP-2C	N/A
		96"	V96SP-2C	525	V96DP-2C	697

Villa Accessories	Description	Model Number	List
 Villa RJ45 Data Keystone	- Fits into blank data knockouts	V-RJ45	72
 Villa HDMI Keystone	- Fits into blank data knockouts	V-HDMI	76
 Villa USB-C Keystone	- Fits into blank data knockouts (Keystone only)	V-USB-C	46
	- Keystone with 3ft C-C Cable	V-USB-C-CORD	105

"Villa" and "Daisylink" are trademarks of Dekko.

Accessories

Cove™ Daisylink™ System

The Cove Daisylink system is a 4 wire, 2 circuit hardwire system which allows for non-sequential plug and play use. Link up to 20 single kits or 10 double kits in a row using one of three power infeed options.

Grommet holes are pre-routed in the top. All outlets and body of unit is black.

3 face plate finishes available:

- BL: Black
- SV: Silver
- WH: White

Infeeds: You must specify a power infeed unit for each row or grouping of tables. The number of kits that can be supported per row varies depending on the infeed specified.



Single Kit includes:

- 1 Cove power base
- 1 FM cable
- 1 FF cable
- 4 cable clamps
- 1 grommet (on -L / -F models)



Double Kit includes:

- 2 Cove power bases
- 1 FM cable
- 2 FF cable
- 6 cable clamps
- 2 grommets (on -L / -F models)





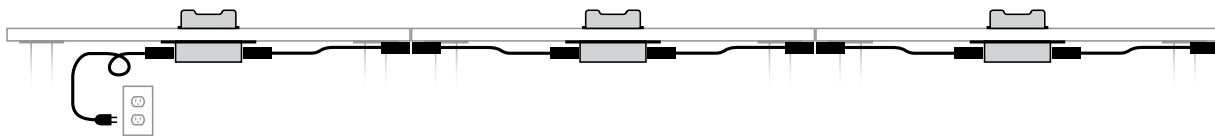





How Does the Cove Daisylink System Work?

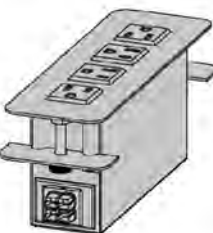

Daisylink Accessories	Description	Visual	Cord	Model Number	Price
20/15 AMP Plug Infeed 	- 20 AMP outlet with standard 15 AMP adapter can be plugged into any standard wall outlet. - Feeds up to 10 units.		72	VAP-72	\$231
Hardwire Infeed 	- 2 circuit system hardwired into wall and plugs into first table in the row. - Feeds up to 20 units.		72	VHW-72	184
Quick Disconnect Kit 	- Hardwired wall unit paired with an FF jumper unit which plugs into first table in the row. - Feeds up to 20 units.		72	VQD-72	307
FM Jumper Unit 	- Great for linking tables around a corner, face to face, bypassing a non-powered table, or two tables that are not in perfect alignment.		12 24 36 48 60 72	VFM-12 VFM-24 VFM-36 VFM-48 VFM-60 VFM-72	100 118 136 155 172 191
Splitter 	- Splits power to feed tables running in different directions			VT-MFM	159

accessories

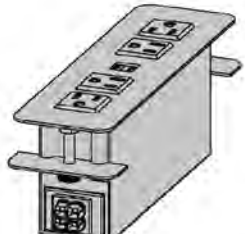
Single Cove Kits	Double Cove Kits
------------------	------------------

Cove Daisylink Kits	Face Plate	Table Size	Model No.	List	Model No.	List
2 Power 	2.5 x 5" 	36"	C36SP-2P	507	N/A	N/A
		48"	C48SP-2P	507	N/A	N/A
		60"	C60SP-2P	507	C60DP-2P	888
		72"	C72SP-2P	507	C72DP-2P	888
		84"	C84SP-2P	N/A	C84DP-2P	888
		96"	C96SP-2P	N/A	C96DP-2P	888
2 Power + 2 USB 	2.5 x 5.75" 	36"	C36SP-2P-2U	659	N/A	N/A
		48"	C48SP-2P-2U	659	N/A	N/A
		60"	C60SP-2P-2U	659	C60DP-2P-2U	1,186
		72"	C72SP-2P-2U	659	C72DP-2P-2U	1,186
		84"	C84SP-2P-2U	N/A	C84DP-2P-2U	1,186
		96"	C96SP-2P-2U	N/A	C96DP-2P-2U	1,186
4 Power 	2.5 x 7.75" 	36"	C36SP-4P	731	N/A	N/A
		48"	C48SP-4P	731	N/A	N/A
		60"	C60SP-4P	731	C60DP-4P	1,334
		72"	C72SP-4P	731	C72DP-4P	1,334
		84"	C84SP-4P	N/A	C84DP-4P	1,334
		96"	C96SP-4P	N/A	C96DP-4P	1,334
4 Power + 2 USB 	2.5 x 8.75" 	36"	C36SP-4P-2U	882	N/A	N/A
		48"	C48SP-4P-2U	882	N/A	N/A
		60"	C60SP-4P-2U	882	C60DP-4P-2U	1,633
		72"	C72SP-4P-2U	882	C72DP-4P-2U	1,633
		84"	C84SP-4P-2U	N/A	C84DP-4P-2U	1,633
		96"	C96SP-4P-2U	N/A	C96DP-4P-2U	1,633

Villa™ Corded System

This system is built with easy plug-and-play capabilities and reconfiguration in mind. Each table can be plugged into the wall separately or can be piggy-backed off of the next table. (Max of 6 units in any run.)







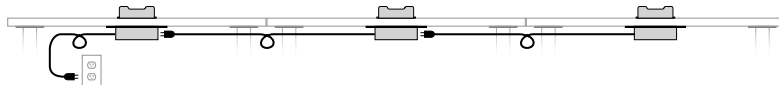

- 3 finishes available:**
- BL: Black grommet, black body
 - SV: Silver grommet, silver body
 - WH: White grommet, black body

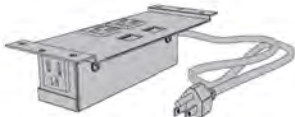

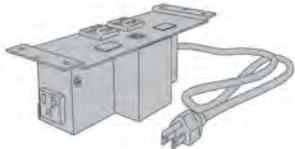
Grommet holes are pre-routed in the top, and each unit comes with a flush grommet cover.

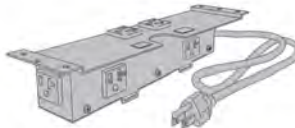

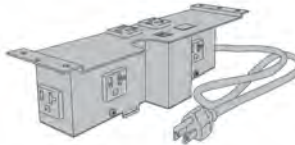
How Does the Villa Corded System Work?

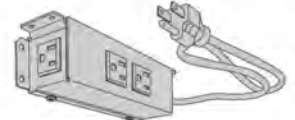

Villa Corded Units	Grommet Cover	Model Number	Cord	Color	List
2 Power + 1 Convenience + 2 KO 	3.25 x 5.5" Flush 	VC-2P-1C-_-_-	-36 -72 -108	-BL -SV	\$ 338
2 Power + 2 USB + 1 Convenience + 2 KO 	3.25 x 5.5" Flush 	VC-2P-2U-1C-_-_-	-36 -72 -108	-BL -SV	\$ 490
2 Power + 3 Convenience + 2 KO 	3.25 x 5.5" Flush 	VC-2P-3C-_-_-	-36 -72 -108	-BL -SV	\$ 392
2 Power + 2 USB + 3 Convenience + 1 KO 	3.25 x 5.5" Flush 	VC-2P-2U-3C-_-_-	-36 -72 -108	-BL -SV	\$ 536
3 Convenience Undermount 	None	VC-3C-_-_-	-36 -72 -108	-BL -SV	\$ 242

Villa Accessories	Description	Model Number	List
Villa RJ45 Data Keystone 	- Fits into blank data knockouts	V-RJ45	72
Villa HDMI Keystone 	- Fits into blank data knockouts	V-HDMI	76
Villa USB-C Keystone 	- Fits into blank data knockouts (Keystone only) - Keystone with 3ft C-C Cable	V-USB-C V-USB-C-CORD	46 105

"Villa" is a trademark of Dekko.

Cove™ Corded System

Smooth access to power and USB power that runs flush to the table top.

Some models are available with convenience outlets to allow table to be piggy-backed off of the next table. (Max of 6 units in any run.)

Grommet holes are pre-routed in the top. All outlets and body of unit is black.

3 face plate finishes available:



- BL: Black
- SV: Silver
- WH: White



Cove Corded Units	Face Plate	Specs	Model Number	Color	List	
		2.5 x 5"	Rectangle	CC108-2P	-BL -SV	\$ 339
		6"	Round	CC108-2P-RD	-BL -SV	\$ 339
		2.5 x 5.75"	Rectangle +1 Convenience	CC108-2P-1C	-BL -SV	\$ 362
		6"	Round	CC108-2P-1C-RD	-BL -SV	\$ 362
		2.5 x 7.75"	Rectangle +2 Convenience	CC108-2P-2U-2C	-BL -SV	\$ 638
		6"	Round	CC108-2P-2U-2C-RD	-BL -SV	\$ 638
		2.5 x 7.75"	Rectangle	CC108-4P	-BL -SV	\$ 561
		6"	Round	CC108-4P-RD	-BL -SV	\$ 561
		2.5 x 8.75"	Rectangle	CC108-4P-2U	-BL -SV	\$ 608
		6"	Round	CC108-4P-2U-RD	-BL -SV	\$ 608
		2.5 x 10.75"	Rectangle	CC108-6P	-BL -SV	\$ 585
		6"	Round	CC108-6P-RD	-BL -SV	\$ 585
		2.5 x 13.25"	Rectangle	CC108-6P-4U	-BL -SV	\$ 808
		6"	Round	CC108-6P-4U-RD	-BL -SV	\$ 808

"Cove" is a trademark of Dekko.

Product	Description	Length	Model Number	Color	Price
Built-in Wire Management Leg 	1 x 19" steel hinged access door built into one base. Door runs within 2.5" of top plate and bottom of base. Door height varies depending on series and options. Not available on all series. Check series intro for compatibility.	N/A	-WM	matches base color	+ \$139 - - -
Snap-on Wire Management Leg Cover 	Snaps on to round columns and offers coverage of wires down the leg. Check series intro for compatibility. Powdercoated steel to match base color (not available in chrome). Available for 2" and 3" columns.	N/A	-WMLC.2 -WMLC.3	matches base color	50 79 - -
Magnetic Wire Management Leg Cover 	Magnetically attaches to rectangular and square bases, offering coverage of wires down the leg. Check series intro for compatibility. Powdercoated steel to match base color.	N/A	-MMLC	matches base color	71 - - -
Vertical Spine Management 3 x 1.5 	Oval spine conceals and carries wires from under desk to floor. Single channel on each side to keep cords separate where code requires. Screws to under side of worksurface with weighted base. Available in Silver Metallic.	30" 42"	WMH WMH-SH	Silver Silver	174 241 - -
J-Channel Management 3.25 x 1" 	Ideal when cords need to be moved often. Can be attached to underside of the table or to a modesty panel. Self adhesive tape applied for easy installation. Black plastic.	12" 36" 60" 72"	WMA1 WMA3 WMA5 WMA6	Black Black Black Black	108 139 191 205 -
Wave Cable Gripper 5.75" x 1.75" 	This cable manager features an intelligent design that allows wires to slip into the unit. Place these grips anywhere you need to get wires under control. Simple to install with only two screws, users can easily move to different positions as their work environment changes.	N/A	CG4	Black	18

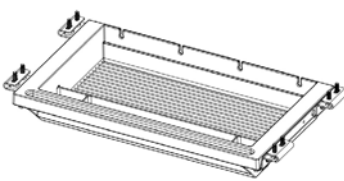
Product	Description	Length	Model Number	Color	Price
Vertebrae Management 3.125 x 1" 	Contains four separate channels. Two main channels and two smaller which allow wires to sit in a .5" trough. Black plastic.	36"	WMD3	Black	\$ 114
Grommet 2.75 x 2.75" 	Add grommets to any table top for \$45 each. Use chart below to select grommet location. For example, add "-GR.D" at the end of the model number for a table needing two grommets in location D and add \$89 to the list price. Black plastic.	N/A	-GR._ _	Black	45 ea.
MINI Drawer 13.6"w x 8"d x 2"h 	A thin-profile, non-locking drawer with ball bearing slides designed to fit underneath work surfaces, especially height-adjustable tables. The MINI drawer is only 8" in depth and features a tray that can slide across the drawer and can also be removed and placed on the work surface to hold accessories or personal items. The tray also allows for easy-access storage inside the drawer. Wire management slots on the backside of the MINI allow the user to place items such as their mobile phone inside and then draw the charging cord out the back.	N/A	-MD	Black	104

Where Would You Like Your Grommets? For custom locations, please provide a drawing with your order.

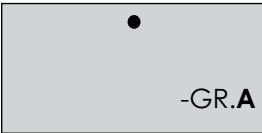
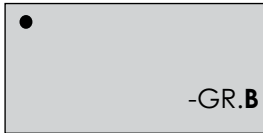
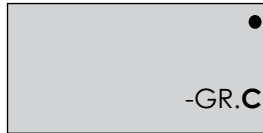
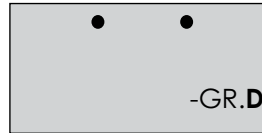
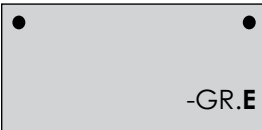
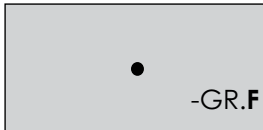
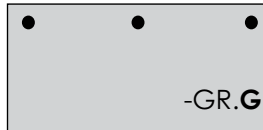
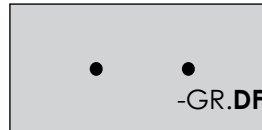
 -GR.A	 -GR.B	 -GR.C	 -GR.D
 -GR.E	 -GR.F	 -GR.G	 -GR.DF

Please note: GR.F and GR.DF are NOT available on nesting tables