

# table~~x~~

## 74 vertiGo price list

Effective January 1, 2025

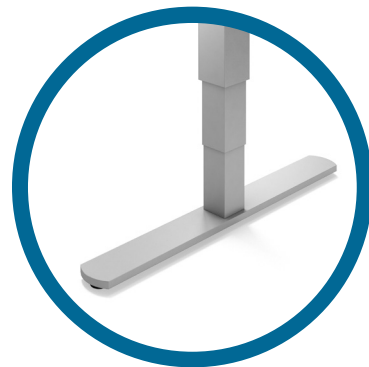



Adjusting one's work surface height has become the most personal and impactful detail within a workspace. VertiGo is designed to go from sit-to-stand, and any height in between, with ease. Match with static or nesting tables for a cohesive look throughout a space.

## VertiGo Base Styles

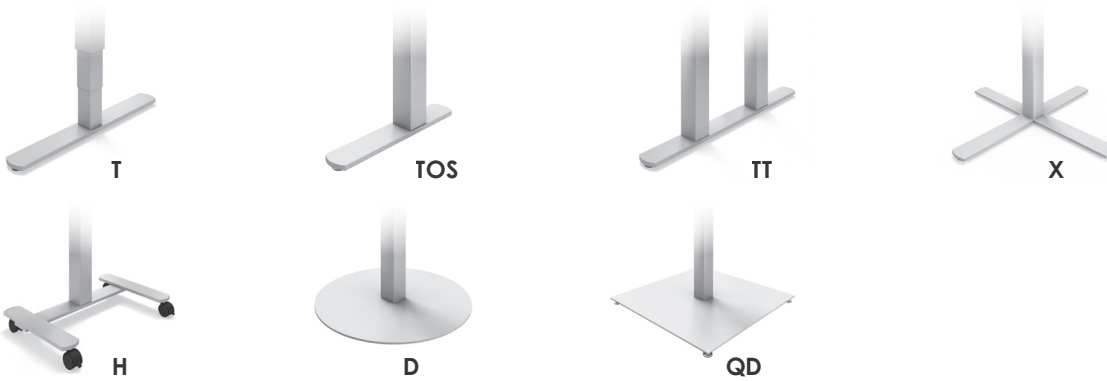

## VertiGo Options

Standard Glides



Locking Casters

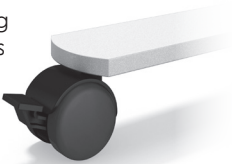

- LC Locking Casters**  
can be added to any table for \$111 per set of four.
- FD Folding Bases**  
are not available on VertiGo tables.
- NE Nesting Tables**  
priced accordingly with locking casters.
- FT Flip Tops**  
available on X-based and H-based tables for \$138. Not available on counterbalanced tables.

- WM Wire Management**  
Built-in wire management is not available on VertiGo tables.
- MMLC Magnetic Wire Management Leg Covers**  
Magnetically attaches onto any square leg and are \$71 each.
- OS Offset T-bases**  
available for \$39 per table. Offset is not available on 18"d tables or 30"d nesting tables less than 60" wide.

- SH Special Height** can be added to any table:  
+ \$72 per column for heights > 29"  
+ \$39 per column for heights < 29"  
Special height tables with tops larger than 36x72" must be custom quoted.
- FR Footring** available for \$166 per disc base. Not available for height adjustable bases.
- CH Chrome Finish** is not available on VertiGo tables.

## VertiGo Height Adjustable Options

**RA Ratchet**  
**NE RA** is available on T-bases and nesting for \$536 list per table. Available height adjustable finishes can be found on page 9.

**CR Hand Crank**  
**NE CR** is available on most T-, X-, and L-bases and some nesting models as listed. Available height adjustable finishes can be found on page 9.

**BL Counterbalanced and Short Balanced**  
**BLS** are available on disc and X-bases. Available height adjustable finishes can be found on page 9.

**EH Electric Height** is available on T- and TT-bases and are available in two finishes:

- 37 Satin Silver
- 57 Jet

Two-leg counterbalanced units are only available in three finishes:

- 30 Pearl
- 37 Satin Silver
- 57 Jet

## VertiGo Top Shapes

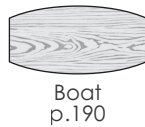

## VertiGo Top Options

**QG Quick-Connect Ganging Brackets** can be added to any table for \$45 (includes 4 connectors per table).

**RC 3" Radius Corners** can be added to any table for \$61.

**GR Grommets** can be added to any table for \$45 each. To see specific locations, see page 233.

## VertiGo Edge Options

(corresponds with 3 columns of pricing)

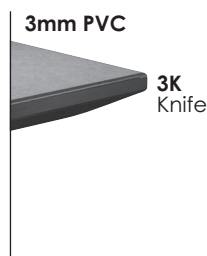
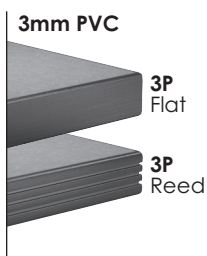

## Ratchet Height Adjustability

Ratchet height adjustability is available on most tables in the VertiGo line... T-bases, X-bases, and even disc bases. Simply lift the top near the base's mounting plate, and the ratchet clicks into place. With a range of 9.45" the ratchet works in thirteen increments of .78". To reset to the lowest position just lift past its highest point.

will be adjusted to ensure that the range of mobile tables is consistent with that of static tables.

**To specify:**  
All available ratchet models are priced in the following pages. They are denoted by the "RA" at the end of the model number.

**Example:**  
74TC2060T18RA-3P  
20x60" **ratchet** table  
**\$1,401** List Price

Want to use VertiGo on the go? Casters can be added, and the height of the base



Both bases are clearly marked to ensure your table is level.

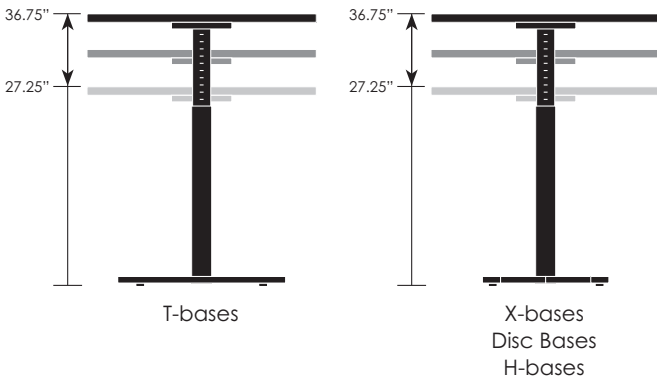

## Nesting Ratchet

Ratchet height adjustability is also available on many of the nesting T-base models in the VertiGo line. All available nesting models are denoted by the "NE" at the end of the model number. To add the ratchet option to those models, change the "NE" to "NERA" and add **\$536** to the list price.

**Example:**  
74TC2060T18NERA-3P  
20x60" **nesting ratchet** table  
**\$1,685 + 536 = \$2,221** List Price

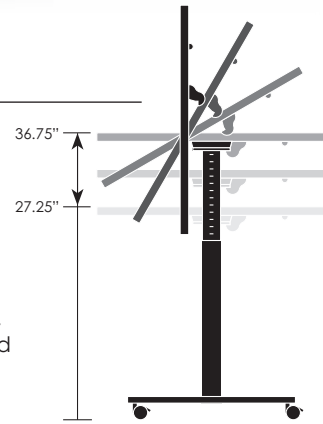

## Manual Hand Crank Height Adjustability

Need the flexibility of infinite adjustability without the budget for counterbalanced bases? Our manual hand crank offers a cost-effective alternative.

"CR" at the end of the model number.

**Example:**  
74TC2060T18CR-3P  
20x60" **hand crank** table  
**\$1,567** List Price

**To specify:**  
All available hand crank models are priced in the following pages. They are denoted by the

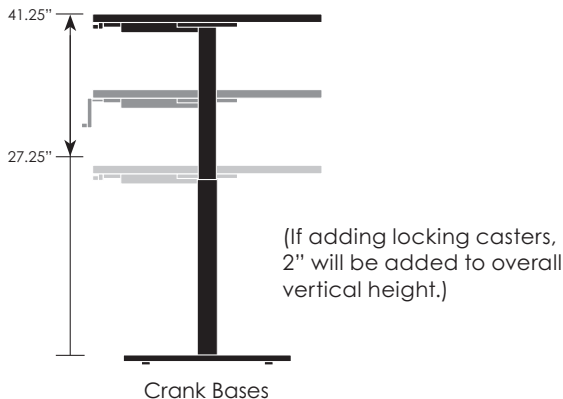
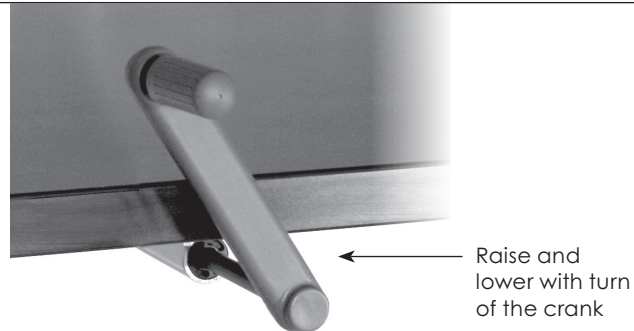

## Nesting Hand Crank

Introducing hand crank height adjustable tables that nest! Only available on rectangular tables 20x60" to 36x72". These models are denoted by the "NECR" at the end of the model number.

**Example:**  
74TC2060T18NECR-3P  
20x60" **nesting hand crank** table  
**\$2,443** List Price



## Electric Height Adjustability

Electric height adjustability gives you the ability to adjust tables at the push of a button. The standard memory keypad will remember your four favorite heights. Available on both VertiGo T and TT-bases, this option works great in private offices or even in conference rooms.

**To specify:**  
All available electric models are priced in the following pages. They are denoted by the "EH" at the end of the model number.

**Example:**  
74TC2060T18EH-3P  
20x60" **electric height** table  
**\$3,086** List Price

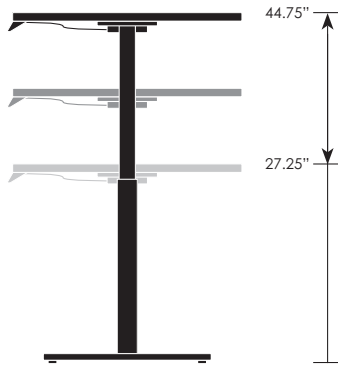

Electric T-bases

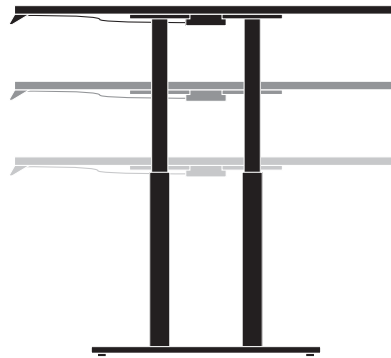

Electric TT-bases



← Optional magnetic wire management leg cover.

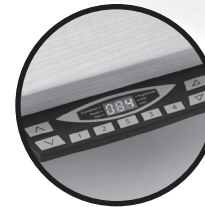

Retractable Memory Keypad

## Counterbalanced & Short Balanced Height Adjustability

Counterbalanced tables go from seated-to-standing height, while the short balanced goes from coffee-to-seated height. Available on tables using single column disc or X-bases, these tables are easy to adjust. Simply squeeze the small handle underneath and gently move the top to your desired height. It's that easy.

Want to use VertiGo on the go? Simply add 2" to each vertical measurement to account for the added height of locking casters.

**To specify:**  
All available counterbalanced models are priced in the following pages. They are denoted by the "BL" or "BLS" (for short balanced) at the end of the model number.

**Example:**  
74RD36X32BL-3P  
36" round **counterbalanced** table  
**\$1,535** List Price

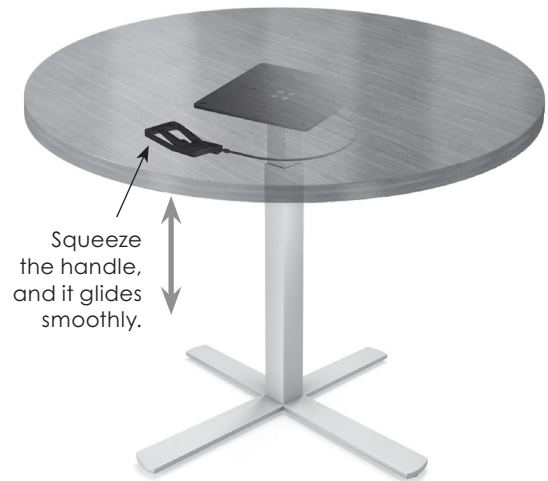

Squeeze the handle, and it glides smoothly.

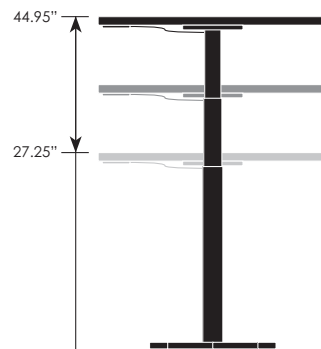

**BL** Counterbalanced disc or X-bases

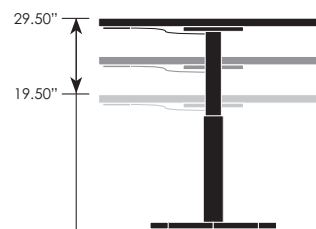

**BLS** Short balanced disc or X-bases





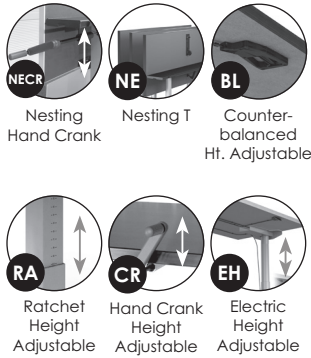



vertiGo

Rectangular with T-bases	Top Size	Base	Model Number	3P	3K	3W
	20 x 36	Static	74TC2036T18	\$ 777	\$ 851	\$ 930
		Nesting	74TC2036T18NE	1,597	1,671	1,750
		Ratchet	74TC2036T18RA	1,313	1,388	1,466
		Crank	74TC2036T18CR	1,479	1,553	1,632
		Electric	74TC2036T18EH	2,998	3,073	3,151
	20 x 48	Static	74TC2048T18	837	936	1,025
		Nesting	74TC2048T18NE	1,657	1,756	1,845
		Ratchet	74TC2048T18RA	1,373	1,472	1,561
		Crank	74TC2048T18CR	1,539	1,638	1,727
		Count Bal	74TC2048T18BL	2,619	2,717	2,806
		Electric	74TC2048T18EH	3,058	3,157	3,246
	20 x 60	Static	74TC2060T18	865	975	1,084
		Nesting	74TC2060T18NE	1,685	1,795	1,904
		Ratchet	74TC2060T18RA	1,401	1,511	1,620
		Crank	74TC2060T18CR	1,567	1,677	1,786
Nest/Crank		74TC2060T18NECR	2,443	2,553	2,662	
Count Bal		74TC2060T18BL	2,677	2,787	2,896	
Electric		74TC2060T18EH	3,086	3,196	3,305	
20 x 72	Static	74TC2072T18	917	1,048	1,170	
	Nesting	74TC2072T18NE	1,978	2,108	2,231	
	Ratchet	74TC2072T18RA	1,538	1,669	1,791	
	Crank	74TC2072T18CR	1,704	1,835	1,957	
	Nest/Crank	74TC2072T18NECR	2,547	2,678	2,800	
	Count Bal	74TC2072T18BL	2,830	2,961	3,083	
	Electric	74TC2072T18EH	3,223	3,354	3,476	
20 x 84	Static	74TC2084T18	1,103	1,274	1,395	
	Nesting	74TC2084T18NE	2,079	2,250	2,371	
	Electric	74TC2084T18EH	3,324	3,495	3,616	
20 x 90 *	Static	74TC2090T18	1,163	1,358	1,476	
	Nesting	74TC2090T18NE	2,139	2,334	2,451	
	Electric	74TC2090T18EH	3,384	3,579	3,697	
20 x 96 *	Static	74TC2096T18	1,163	1,358	1,490	
	Nesting	74TC2096T18NE	2,139	2,334	2,466	
	Electric	74TC2096T18EH	3,384	3,579	3,711	
24 x 36	Static	74TC2436T22	796	871	958	
	Nesting	74TC2436T22NE	1,628	1,702	1,790	
	Ratchet	74TC2436T22RA	1,332	1,407	1,495	
	Crank	74TC2436T22CR	1,495	1,569	1,657	
	Electric	74TC2436T22EH	3,013	3,087	3,175	
24 x 48	Static	74TC2448T22	856	955	1,053	
	Nesting	74TC2448T22NE	1,676	1,775	1,873	
	Ratchet	74TC2448T22RA	1,392	1,491	1,590	
	Crank	74TC2448T22CR	1,555	1,653	1,752	
	Count Bal	74TC2448T22BL	2,638	2,736	2,835	
	Electric	74TC2448T22EH	3,073	3,172	3,270	









\* \$200 NET surcharge per order for oversized pallet

For VertiGo table options, please reference pages 182-183.

Top Size	Base	Model Number	3P	3K	3W	Rectangular with T-bases
24 x 60	Static	74TC2460T22	\$ 884	\$ 994	\$ 1,113	 
	Nesting	74TC2460T22NE	1,704	1,814	1,933	
	Ratchet	74TC2460T22RA	1,420	1,530	1,649	
	Crank	74TC2460T22CR	1,583	1,693	1,811	
	Nest/Crank	74TC2460T22NECR	2,460	2,570	2,689	
	Count Bal	74TC2460T22BL	2,696	2,806	2,925	
	Electric	74TC2460T22EH	3,101	3,211	3,330	
24 x 72	Static	74TC2472T22	936	1,067	1,199	   Nesting Hand Crank    Nesting T    Counter-balanced Ht. Adjustable
	Nesting	74TC2472T22NE	1,997	2,127	2,259	
	Ratchet	74TC2472T22RA	1,472	1,603	1,735	
	Crank	74TC2472T22CR	1,635	1,765	1,897	
	Nest/Crank	74TC2472T22NECR	2,564	2,695	2,827	
	Count Bal	74TC2472T22BL	2,766	2,896	3,028	
	Electric	74TC2472T22EH	3,153	3,284	3,416	
24 x 84	Static	74TC2484T22	1,122	1,293	1,424	   Ratchet Height Adjustable    Hand Crank Height Adjustable    Electric Height Adjustable
	Nesting	74TC2484T22NE	2,098	2,269	2,399	
	Electric	74TC2484T22EH	3,339	3,510	3,640	
24 x 90 *	Static	74TC2490T22	1,182	1,377	1,504	
	Nesting	74TC2490T22NE	2,158	2,353	2,480	
	Electric	74TC2490T22EH	3,399	3,594	3,721	
24 x 96 *	Static	74TC2496T22	1,182	1,377	1,519	
	Nesting	74TC2496T22NE	2,158	2,353	2,494	
	Electric	74TC2496T22EH	3,399	3,594	3,735	
30 x 36	Static	74TC3036T26	860	952	1,041	
	Nesting	74TC3036T26NE	1,680	1,772	1,861	
	Ratchet	74TC3036T26RA	1,397	1,489	1,578	
	Crank	74TC3036T26CR	1,557	1,649	1,738	
	Electric	74TC3036T26EH	3,076	3,168	3,257	
30 x 48	Static	74TC3048T26	934	1,057	1,152	
	Nesting	74TC3048T26NE	1,754	1,877	1,972	
	Ratchet	74TC3048T26RA	1,472	1,594	1,689	
	Crank	74TC3048T26CR	1,631	1,754	1,849	
	Count Bal	74TC3048T26BL	2,718	2,840	2,935	
	Electric	74TC3048T26EH	3,150	3,272	3,368	
30 x 60	Static	74TC3060T26	958	1,089	1,206	
	Nesting	74TC3060T26NE	1,778	1,909	2,026	
	Ratchet	74TC3060T26RA	1,495	1,626	1,743	
	Crank	74TC3060T26CR	1,655	1,786	1,903	
	Nest/Crank	74TC3060T26NECR	2,530	2,661	2,778	
	Count Bal	74TC3060T26BL	2,771	2,903	3,020	
	Electric	74TC3060T26EH	3,174	3,305	3,422	

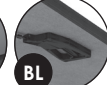
\* \$200 NET surcharge per order for oversized pallet





**For VertiGo table options, please reference pages 182-183.**



Rectangular with T-bases	Top Size	Base	Model Number	3P	3K	3W
	30 x 72	Static	74TC3072T26	\$ 1,016	\$ 1,171	\$ 1,299
		Nesting	74TC3072T26NE	2,077	2,231	2,360
		Ratchet	74TC3072T26RA	1,553	1,708	1,836
		Crank	74TC3072T26CR	1,713	1,868	1,996
		Nest/Crank	74TC3072T26NECR	2,640	2,795	2,923
		Count Bal	74TC3072T26BL	2,844	2,999	3,127
		Electric	74TC3072T26EH	3,232	3,387	3,515
		30 x 84	Static	74TC3084T26	1,243	1,455
Nesting	74TC3084T26NE		2,219	2,431	2,545	
Electric	74TC3084T26EH		3,459	3,671	3,785	
30 x 90 *	Static	74TC3090T26	1,318	1,560	1,666	
	Electric	74TC3090T26EH	3,534	3,775	3,882	
30 x 96 *	Static	74TC3096T26	1,318	1,560	1,680	
	Electric	74TC3096T26EH	3,534	3,775	3,896	
  	36 x 48	Static	74TC3648T26	993	1,139	1,231
		Nesting	74TC3648T26NE	1,953	2,099	2,191
		Ratchet	74TC3648T26RA	1,531	1,676	1,768
		Crank	74TC3648T26CR	1,690	1,836	1,928
		Count Bal	74TC3648T26BL	2,777	2,922	3,014
		Electric	74TC3648T26EH	3,209	3,355	3,447
  	36 x 60	Static	74TC3660T26	1,082	1,264	1,358
		Nesting	74TC3660T26NE	2,116	2,298	2,392
		Ratchet	74TC3660T26RA	1,620	1,801	1,895
		Crank	74TC3660T26CR	1,779	1,961	2,055
		Nest/Crank	74TC3660T26NECR	2,707	2,888	2,982
		Count Bal	74TC3660T26BL	2,896	3,077	3,171
		Electric	74TC3660T26EH	3,298	3,480	3,574
		36 x 72	Static	74TC3672T26	1,139	1,343
Nesting	74TC3672T26NE		2,199	2,403	2,509	
Ratchet	74TC3672T26RA		1,676	1,880	1,986	
Crank	74TC3672T26CR		1,836	2,039	2,145	
Nest/Crank	74TC3672T26NECR		2,763	2,967	3,072	
Count Bal	74TC3672T26BL		2,967	3,170	3,276	
Electric	74TC3672T26EH		3,354	3,558	3,664	
36 x 84	Static	74TC3684T26	1,385	1,638	1,736	
	Electric	74TC3684T26EH	3,601	3,854	3,952	
36 x 90 *	Static	74TC3690T26	1,473	1,761	1,847	
	Electric	74TC3690T26EH	3,689	3,977	4,063	
36 x 96 *	Static	74TC3696T26	1,473	1,761	1,862	
	Electric	74TC3696T26EH	3,689	3,977	4,077	

\* \$200 NET surcharge per order for oversized pallet

For VertiGo table options, please reference pages 182-183.





Top Size	Base	Model Number	3P	3K	3W	Rectangular with TT-bases
42 x 60	Static	74TC4260TT32	\$ 1,955	\$ 2,167	\$ 2,252	   Nesting TT  Electric Height Adjustable
	Nesting	74TC4260TT32NE	3,111	3,324	3,409	
	Electric	74TC4260TT32EH	6,224	6,436	6,521	
42 x 72	Static	74TC4272TT32	2,061	2,316	2,398	
	Nesting	74TC4272TT32NE	3,217	3,472	3,554	
	Electric	74TC4272TT32EH	6,330	6,585	6,667	
42 x 84	Static	74TC4284TT32	2,247	2,543	2,623	
	Electric	74TC4284TT32EH	6,516	6,812	6,892	
42 x 90 *	Static	74TC4290TT32	2,346	2,681	2,746	
	Electric	74TC4290TT32EH	6,615	6,950	7,015	
42 x 96 *	Static	74TC4296TT32	2,346	2,681	2,760	
	Electric	74TC4296TT32EH	6,615	6,950	7,029	
48 x 60	Static	74TC4860TT36	1,993	2,217	2,308	
	Nesting	74TC4860TT36NE	3,150	3,374	3,465	
	Electric	74TC4860TT36EH	8,990	9,213	9,304	
48 x 72	Static	74TC4872TT36	2,162	2,453	2,522	
	Nesting	74TC4872TT36NE	3,318	3,609	3,679	
	Electric	74TC4872TT36EH	9,158	9,449	9,518	
48 x 84	Static	74TC4884TT36	2,257	2,553	2,647	
	Electric	74TC4884TT36EH	9,254	9,549	9,644	
48 x 90 *	Static	74TC4890TT36	2,357	2,693	2,772	
	Electric	74TC4890TT36EH	9,354	9,689	9,768	
48 x 96 *	Static	74TC4896TT36	2,357	2,693	2,786	
	Electric	74TC4896TT36EH	9,354	9,689	9,782	

Top Size	Base	Model Number	3P	3K	3W	Rectangular with 3 TT-bases
42 x 120	Static	74TC42120TT32(3)-TJ	\$ 3,384	\$ 3,882	\$ 3,897	 
42 x 144	Static	74TC42144TT32(3)-TJ	3,588	4,167	4,178	
48 x 120	Static	74TC48120TT36(3)-TJ	3,411	3,914	3,940	
48 x 144	Static	74TC48144TT36(3)-TJ	3,617	4,202	4,224	

LC SH ⊗  
 N/A quote 3 bases:

\* \$200 NET surcharge per order for oversized pallet

For VertiGo table options, please reference pages 182-183.

Boat-shaped with T-bases	Top Size	Base	Model Number	3P	3K	3W
 	30 x 42 x 84	Static	74BT3084T26	\$ 1,756	\$ 2,158	\$ 2,115
		Electric	74BT3084T26EH	3,972	4,373	4,331
	30 x 42 x 90 *	Static	74BT3090T26	1,899	2,356	2,286
		Electric	74BT3090T26EH	4,114	4,572	4,502
	30 x 42 x 96 *	Static	74BT3096T26	1,899	2,356	2,300
		Electric	74BT3090T26EH	4,114	4,572	4,516



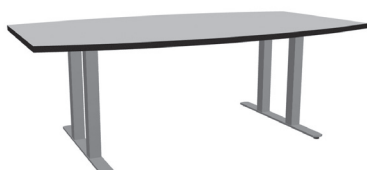

Electric Height Adjustable

Boat-shaped with TT-bases	Top Size	Base	Model Number	3P	3K	3W
 	36 x 48 x 84	Static	74BT3684TT36	\$ 2,662	\$ 3,119	\$ 3,043
		Electric	74BT3684TT36EH	9,658	10,116	10,040
	36 x 48 x 90 *	Static	74BT3690TT36	2,824	3,346	3,235
		Electric	74BT3690TT36EH	9,820	10,342	10,232
	36 x 48 x 96 *	Static	74BT3696TT36	2,824	3,346	3,250
		Electric	74BT3696TT36EH	9,820	10,342	10,246

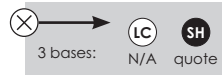

Electric Height Adjustable

Boat-shaped with 3 TT-bases	Top Size	Base	Model Number	3P	3K	3W
 	36 x 48 x 120	Static	74BT36120TT36(3)-TJ	\$ 3,986	\$ 4,718	\$ 4,522
	36 x 48 x 144	Static	74BT36144TT36(3)-TJ	4,309	5,171	4,935
	 <p>3 bases: LC SH N/A quote</p>					

\* \$200 NET surcharge per order for oversized pallet

For VertiGo table options, please reference pages 182-183.

Top Size	Base	Model Number	3P	3K	3W	Racetrack with T-bases
36 x 60	Static	74RT3660T26	\$ 1,369	\$ 1,665	\$ 1,636	   
	Nesting	74RT3660T26NE	2,329	2,625	2,596	
	Ratchet	74RT3660T26RA	1,906	2,202	2,173	
	Crank	74RT3660T26CR	2,066	2,362	2,333	
	Count Bal	74RT3660T26BL	3,183	3,479	3,450	
	Electric	74RT3660T26EH	3,585	3,881	3,852	
36 x 72	Static	74RT3672T26	1,369	1,665	1,665	  
	Nesting	74RT3672T26NE	2,403	2,699	2,699	
	Ratchet	74RT3672T26RA	1,906	2,202	2,202	
	Crank	74RT3672T26CR	2,066	2,362	2,362	
	Count Bal	74RT3672T26BL	3,197	3,493	3,493	
	Electric	74RT3672T26EH	3,585	3,881	3,881	
36 x 84	Static	74RT3684T26	1,753	2,153	2,104	   
	Electric	74RT3684T26EH	3,969	4,369	4,319	
36 x 90 *	Static	74RT3690T26	1,899	2,356	2,278	   
	Electric	74RT3690T26EH	4,114	4,572	4,494	
36 x 96 *	Static	74RT3696T26	1,899	2,356	2,292	   
	Electric	74RT3696T26EH	4,114	4,572	4,508	

Top Size	Base	Model Number	3P	3K	3W	Racetrack with TT-bases
42 x 84	Static	74RT4284TT32	\$2,508	\$2,908	\$2,867	  
	Electric	74RT4284TT32EH	6,777	7,177	7,135	
42 x 90 *	Static	74RT4290TT32	2,653	3,111	3,041	 
	Electric	74RT4290TT32EH	6,922	7,380	7,310	
42 x 96 *	Static	74RT4296TT32	2,653	3,111	3,055	 
	Electric	74RT4296TT32EH	6,922	7,380	7,324	
48 x 84	Static	74RT4884TT36	2,824	3,346	3,221	 
	Electric	74RT4884TT36EH	9,820	10,342	10,217	
48 x 90 *	Static	74RT4890TT36	2,824	3,346	3,235	 
	Electric	74RT4890TT36EH	9,820	10,342	10,232	
48 x 96 *	Static	74RT4896TT36	2,824	3,346	3,250	 
	Electric	74RT4896TT36EH	9,820	10,342	10,246	

Top Size	Base	Model Number	3P	3K	3W	Racetrack with TT-bases
42 x 120	Static	74RT42120TT32(3)-TJ	\$3,953	\$4,678	\$4,480	  
42 x 144	Static	74RT42144TT32(3)-TJ	4,274	5,127	4,889	
48 x 120	Static	74RT48120TT36(3)-TJ	3,986	4,719	4,523	
48 x 144	Static	74RT48144TT36(3)-TJ	4,310	5,172	4,936	

\* \$200 NET surcharge per order for oversized pallet

For VertiGo table options, please reference pages 182-183.

vertiGo

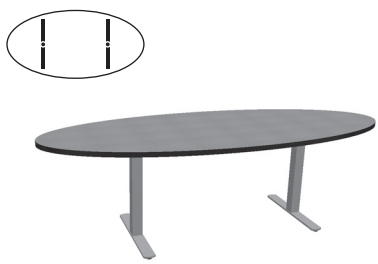
Elliptical with T-bases	Top Size	Base	Model Number	3P	3K	3W
	30 x 54	Static	74EL3054T22	\$ 1,077	\$ 1,264	\$ 1,282
		Ratchet	74EL3054T22RA	1,614	1,801	1,818
		Count Bal	74EL3054T22BL	2,875	3,062	3,123
		Electric	74EL3054T22EH	3,294	3,481	3,499
	30 x 60	Static	74EL3060T22	1,127	1,333	1,348
		Ratchet	74EL3060T22RA	1,663	1,870	1,884
		Count Bal	74EL3060T22BL	2,939	3,145	3,206
		Electric	74EL3060T22EH	3,343	3,550	3,564
	36 x 60	Static	74EL3660T26	1,250	1,499	1,493
		Ratchet	74EL3660T26RA	1,787	2,036	2,030
		Count Bal	74EL3660T26BL	3,064	3,312	3,356
		Electric	74EL3660T26EH	3,466	3,715	3,709
36 x 72	Static	74EL3672T26	1,369	1,665	1,646	
	Ratchet	74EL3672T26RA	1,906	2,202	2,184	
	Count Bal	74EL3672T26BL	3,197	3,493	3,530	
	Electric	74EL3672T26EH	3,585	3,881	3,862	
36 x 84	Static	74EL3684T26	1,618	1,964	1,931	
	Electric	74EL3684T26EH	3,834	4,180	4,146	
36 x 90 *	Static	74EL3690T26	1,737	2,131	2,073	
	Electric	74EL3690T26EH	3,953	4,346	4,288	
36 x 96 *	Static	74EL3696T26	1,737	2,131	2,084	
	Electric	74EL3696T26EH	3,953	4,346	4,300	

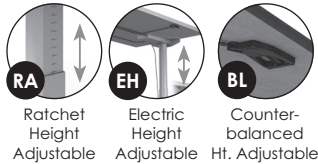

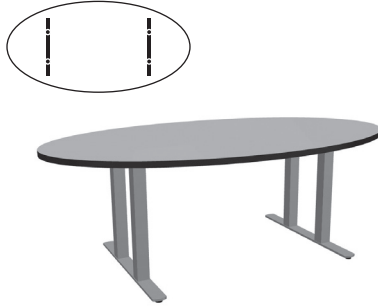
Elliptical with TT-bases	Top Size	Base	Model Number	3P	3K	3W
	42 x 72	Static	74EL4272TT32	\$ 2,288	\$ 2,634	\$ 2,589
		Electric	74EL4272TT32EH	6,557	6,903	6,858
	42 x 84	Static	74EL4284TT32	2,508	2,908	2,845
		Electric	74EL4284TT32EH	6,777	7,177	7,114
	42 x 90 *	Static	74EL4290TT32	2,656	3,115	3,019
		Electric	74EL4290TT32EH	6,925	7,384	7,288
	42 x 96 *	Static	74EL4296TT32	2,656	3,115	3,030
		Electric	74EL4296TT32EH	6,925	7,384	7,299
	48 x 72	Static	74EL4872TT36	2,417	2,810	2,741
		Electric	74EL4872TT36EH	9,413	9,807	9,737
	48 x 84	Static	74EL4884TT36	2,824	3,347	3,203
		Electric	74EL4884TT36EH	9,821	10,343	10,200
	48 x 90 *	Static	74EL4890TT36	2,824	3,347	3,215
		Electric	74EL4890TT36EH	9,821	10,343	10,211
	48 x 96 *	Static	74EL4896TT36	2,824	3,347	3,226
		Electric	74EL4896TT36EH	9,821	10,343	10,222



\* \$200 NET surcharge per order for oversized pallet

For VertiGo table options, please reference pages 182-183.







Top Size	Base	Model Number	3P	3K	3W	Elliptical with 3 TT-bases
42 x 120	Static	74EL42120TT32(3)-TJ	\$3,953	\$4,678	\$4,439	
42 x 144	Static	74EL42144TT32(3)-TJ	4,274	5,127	4,837	
48 x 120	Static	74EL48120TT36(3)-TJ	3,986	4,719	4,486	
48 x 144	Static	74EL48144TT36(3)-TJ	4,310	5,172	4,887	







LC SH ← ⊗  
 N/A quote 3 bases:





Top Size	Base	Model Number	3P	3K	3W	Rectangle with H-base
18 x 30	Static	74TC1830H1524	\$1,080	\$1,137	\$1,209	
	Ratchet	74TC1830H1524RA	1,277	1,334	1,406	
	Count Bal	74TC1830H1524BL	1,670	1,726	1,799	
18 x 36	Static	74TC1836H1524	1,076	1,131	1,219	
	Ratchet	74TC1836H1524RA	1,273	1,328	1,416	
	Count Bal	74TC1836H1524BL	1,666	1,721	1,809	
20 x 30	Static	74TC2030H1524	1,095	1,157	1,230	
	Ratchet	74TC2030H1524RA	1,292	1,354	1,427	
	Count Bal	74TC2030H1524BL	1,684	1,747	1,820	
20 x 36	Static	74TC2036H1524	1,125	1,199	1,278	
	Ratchet	74TC2036H1524RA	1,322	1,396	1,475	
	Count Bal	74TC2036H1524BL	1,715	1,789	1,867	

Top Size	Base	Model Number	3P	3K	3W	Kidney Bean with H-base
18 x 30	Static	74KB1830H1524	\$1,292	\$1,433	\$1,453	
	Ratchet	74KB1830H1524RA	1,489	1,630	1,651	
	Count Bal	74KB1830H1524BL	1,882	2,023	2,043	
18 x 36	Static	74KB1836H1524	1,306	1,453	1,485	
	Ratchet	74KB1836H1524RA	1,503	1,650	1,682	
	Count Bal	74KB1836H1524BL	1,896	2,042	2,075	
20 x 30	Static	74KB2030H1524	1,294	1,436	1,461	
	Ratchet	74KB2030H1524RA	1,491	1,633	1,659	
	Count Bal	74KB2030H1524BL	1,884	2,026	2,051	
20 x 36	Static	74KB2036H1524	1,310	1,459	1,495	
	Ratchet	74KB2036H1524RA	1,507	1,656	1,692	
	Count Bal	74KB2036H1524BL	1,900	2,049	2,085	

For VertiGo table options, please reference pages 182-183.

Square with X-base		Top Size	Base	Model Number	3P	3K	3W
   Ratchet Height Adjustable  Hand Crank Height Adjustable  Short Balanced Ht. Adjustable  Counter-balanced Ht. Adjustable	24 x 24	Static	74SQ2424X22	\$ 786	\$ 836	\$ 913	
		Ratchet	74SQ2424X22RA	983	1,033	1,110	
		Crank	74SQ2424X22CR	1,056	1,107	1,184	
		Short Bal	74SQ2424X22BLS	1,272	1,322	1,399	
	30 x 30	Static	74SQ3030X26	872	950	1,035	
		Ratchet	74SQ3030X26RA	1,070	1,147	1,233	
		Crank	74SQ3030X26CR	1,142	1,219	1,305	
		Short Bal	74SQ3030X26BLS	1,355	1,432	1,518	
	36 x 36	Static	74SQ3636X32	973	1,083	1,173	
		Short Bal	74SQ3636X32BLS	1,454	1,565	1,654	
		Count Bal	74SQ3636X32BL	1,454	1,565	1,654	
	42 x 42	Static	74SQ4242X36	1,089	1,237	1,327	
Short Bal		74SQ4242X36BLS	1,566	1,715	1,805		
Count Bal		74SQ4242X36BL	1,566	1,715	1,805		

Square with Square Disc Base		Top Size	Base	Model Number	3P	3K	3W
   Short Balanced Ht. Adjustable  Counter-balanced Ht. Adjustable  Ratchet Height Adjustable  Disc base: +72	24 x 24	Static	74SQ2424QD16	\$ 798	\$ 848	\$ 926	
		Ratchet	74SQ2424QD16RA	1,001	1,052	1,129	
		Short Bal	74SQ2424QD16BLS	1,449	1,500	1,577	
	30 x 30	Static	74SQ3030QD16	866	943	1,029	
		Ratchet	74SQ3030QD16RA	1,069	1,146	1,232	
		Short Bal	74SQ3030QD16BLS	1,517	1,594	1,680	
	36 x 36	Static	74SQ3636QD20	986	1,097	1,186	
		Short Bal	74SQ3636QD20BLS	1,639	1,749	1,839	
		Count Bal	74SQ3636QD20BL	1,639	1,749	1,839	
	42 x 42	Static	74SQ4242QD26	1,212	1,360	1,450	
		Short Bal	74SQ4242QD26BLS	1,857	2,005	2,095	
		Count Bal	74SQ4242QD26BL	1,857	2,005	2,095	

Square with TT-bases		Top Size	Base	Model Number	3P	3K	3W
   Nesting TT  Electric Height Adjustable	48 x 48	Static	74SQ4848TT36	\$ 1,876	\$ 2,069	\$ 2,154	
		Nesting	74SQ4848TT36NE	3,110	3,303	3,389	
		Electric	74SQ4848TT36EH	8,872	9,065	9,151	

For VertiGo table options, please reference pages 182-183.

Top Size	Base	Model Number	3P	3K	3W	Round with X-base
24 x 24	Static	74RD24X22	\$ 827	\$ 894	\$ 934	
	Ratchet	74RD24X22RA	1,025	1,092	1,132	
	Crank	74RD24X22CR	1,098	1,165	1,205	
	Short Bal	74RD24X22BLS	1,313	1,380	1,420	
30 x 30	Static	74RD30X26	938	1,042	1,077	
	Ratchet	74RD30X26RA	1,135	1,239	1,274	
	Crank	74RD30X26CR	1,207	1,311	1,346	
	Short Bal	74RD30X26BLS	1,421	1,524	1,560	
36 x 36	Static	74RD36X32	1,054	1,196	1,225	
	Short Bal	74RD36X32BLS	1,535	1,678	1,706	
	Count Bal	74RD36X32BL	1,535	1,678	1,706	
42 x 42	Static	74RD42X32	1,182	1,376	1,389	
	Short Bal	74RD42X32BLS	1,663	1,857	1,870	
	Count Bal	74RD42X32BL	1,663	1,857	1,870	
48 x 48	Static	74RD48X36	1,237	1,445	1,470	
	Short Bal	74RD48X36BLS	1,715	1,923	1,948	
	Count Bal	74RD48X36BL	1,715	1,923	1,948	

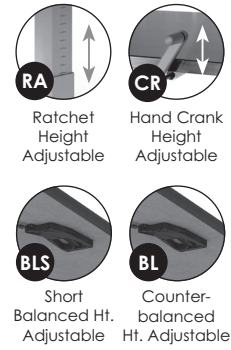



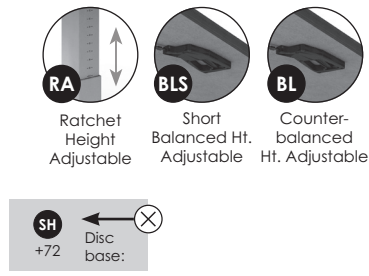



Top Size	Base	Model Number	3P	3K	3W	Round with Disc Base
24 x 24	Static	74RD24D20	\$ 840	\$ 907	\$ 947	
	Ratchet	74RD24D20RA	1,043	1,110	1,150	
	Short Bal	74RD24D20BLS	1,434	1,501	1,541	
30 x 30	Static	74RD30D20	931	1,035	1,070	
	Ratchet	74RD30D20RA	1,135	1,238	1,274	
	Short Bal	74RD30D20BLS	1,525	1,629	1,664	
36 x 36	Static	74RD36D24	1,067	1,210	1,238	
	Short Bal	74RD36D24BLS	1,964	2,107	2,135	
	Count Bal	74RD36D24BL	1,964	2,107	2,135	
42 x 42	Static	74RD42D24	1,195	1,389	1,402	
	Short Bal	74RD42D24BLS	2,092	2,286	2,299	
	Count Bal	74RD42D24BL	2,092	2,286	2,299	
48 x 48	Static	74RD48D32	1,360	1,568	1,593	
	Short Bal	74RD48D32BLS	2,251	2,459	2,484	
	Count Bal	74RD48D32BL	2,251	2,459	2,484	



Top Size	Base	Model Number	3P	3K	3W	Round with TT-bases
48 x 48	Static	74RD48TT32	\$ 1,904	\$ 2,112	\$ 2,137	
	Nesting	74RD48TT32NE	3,138	3,346	3,371	
	Electric	74RD48TT32EH	6,173	6,381	6,405	
54 x 54	Static	74RD54TT32	2,153	2,445	2,429	
	Nesting	74RD54TT32NE	3,348	3,639	3,624	
	Electric	74RD54TT32EH	6,422	6,714	6,698	
60 x 60	Static	74RD60TT36	2,192	2,495	2,494	
	Nesting	74RD60TT36NE	3,387	3,690	3,688	
	Electric	74RD60TT36EH	9,188	9,492	9,490	

For VertiGo table options, please reference pages 182-183.

vertiGo

D-shaped with T-bases	Top Size	Base	Model Number	3P	3K	3W
  <div style="display: flex; justify-content: space-around; margin-top: 20px;"> <div style="text-align: center;">  <p><b>BL</b> Counter-balanced Ht. Adjustable</p> </div> <div style="text-align: center;">  <p><b>EH</b> Electric Height Adjustable</p> </div> <div style="text-align: center;">  <p><b>RA</b> Ratchet Height Adjustable</p> </div> <div style="text-align: center;">  <p><b>CR</b> Hand Crank Height Adjustable</p> </div> </div>	24 x 36	Static	74D2436T22	\$ 856	\$ 954	\$ 1,012
	Ratchet	74D2436T22RA	1,392	1,491	1,548	
	Crank	74D2436T22CR	1,555	1,653	1,711	
	Electric	74D2436T22EH	3,073	3,171	3,229	
	24 x 48	Static	74D2448T22	938	1,069	1,131
	Ratchet	74D2448T22RA	1,474	1,605	1,667	
	Crank	74D2448T22CR	1,637	1,768	1,830	
	Count Bal	74D2448T22BL	2,720	2,851	2,913	
	Electric	74D2448T22EH	3,155	3,286	3,348	
	24 x 60	Static	74D2460T22	1,020	1,184	1,250
	Ratchet	74D2460T22RA	1,556	1,720	1,786	
	Crank	74D2460T22CR	1,719	1,883	1,948	
	Count Bal	74D2460T22BL	2,832	2,996	3,062	
	Electric	74D2460T22EH	3,237	3,401	3,467	
	24 x 72	Static	74D2472T22	1,102	1,299	1,369
	Ratchet	74D2472T22RA	1,638	1,835	1,905	
Crank	74D2472T22CR	1,801	1,997	2,067		
Count Bal	74D2472T22BL	2,932	3,128	3,198		
Electric	74D2472T22EH	3,319	3,516	3,586		
24 x 84	Static	74D2484T22	1,269	1,499	1,573	
Electric	74D2484T22EH	3,486	3,715	3,790		
24 x 90 *	Static	74D2490T22	1,310	1,556	1,632	
Electric	74D2490T22EH	3,527	3,773	3,849		
24 x 96 *	Static	74D2496T22	1,351	1,614	1,692	
Electric	74D2496T22EH	3,568	3,830	3,909		
30 x 48	Static	74D3048T26	1,039	1,203	1,252	
Ratchet	74D3048T26RA	1,576	1,740	1,789		
Crank	74D3048T26CR	1,736	1,900	1,949		
Count Bal	74D3048T26BL	2,822	2,986	3,035		
Electric	74D3048T26EH	3,255	3,419	3,467		
30 x 60	Static	74D3060T26	1,142	1,347	1,393	
Ratchet	74D3060T26RA	1,679	1,884	1,931		
Crank	74D3060T26CR	1,839	2,044	2,090		
Count Bal	74D3060T26BL	2,955	3,161	3,207		
Electric	74D3060T26EH	3,358	3,563	3,609		

\* \$200 NET surcharge per order for oversized pallet

For VertiGo table options, please reference pages 182-183.

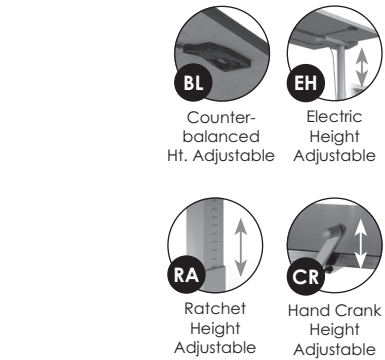

Top Size	Base	Model Number	3P	3K	3W	D-shaped with T-bases
30 x 72	Static	74D3072T26	\$ 1,244	\$ 1,490	\$ 1,535	
	Ratchet	74D3072T26RA	1,781	2,028	2,072	
	Crank	74D3072T26CR	1,941	2,187	2,232	
	Count Bal	74D3072T26BL	3,072	3,318	3,363	
	Electric	74D3072T26EH	3,460	3,706	3,751	
30 x 84	Static	74D3084T26	1,432	1,719	1,761	
	Electric	74D3084T26EH	3,648	3,935	3,977	
30 x 90 *	Static	74D3090T26	1,483	1,791	1,832	
	Electric	74D3090T26EH	3,699	4,007	4,048	
30 x 96 *	Static	74D3096T26	1,534	1,862	1,903	
	Electric	74D3096T26EH	3,750	4,078	4,119	
36 x 48	Static	74D3648T26	1,121	1,318	1,353	
	Ratchet	74D3648T26RA	1,658	1,855	1,890	
	Crank	74D3648T26CR	1,818	2,015	2,050	
	Count Bal	74D3648T26BL	2,904	3,101	3,136	
	Electric	74D3648T26EH	3,337	3,534	3,569	
36 x 60	Static	74D3660T26	1,244	1,490	1,517	
	Ratchet	74D3660T26RA	1,781	2,028	2,054	
	Crank	74D3660T26CR	1,941	2,187	2,214	
	Count Bal	74D3660T26BL	3,058	3,304	3,331	
	Electric	74D3660T26EH	3,460	3,706	3,733	
36 x 72	Static	74D3672T26	1,367	1,663	1,681	
	Ratchet	74D3672T26RA	1,845	2,140	2,159	
	Crank	74D3672T26CR	2,064	2,360	2,378	
	Count Bal	74D3672T26BL	3,195	3,491	3,528	
	Electric	74D3672T26EH	3,583	3,878	3,897	
36 x 84	Static	74D3684T26	1,615	1,960	1,970	
	Electric	74D3684T26EH	3,831	4,176	4,186	
36 x 90 *	Static	74D3690T26	1,677	2,046	2,053	
	Electric	74D3690T26EH	3,893	4,262	4,268	
36 x 96 *	Static	74D3696T26	1,738	2,132	2,134	
	Electric	74D3696T26EH	3,954	4,348	4,350	

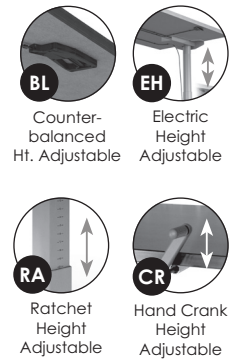

\* \$200 NET surcharge per order for oversized pallet

For VertiGo table options, please reference pages 182-183.

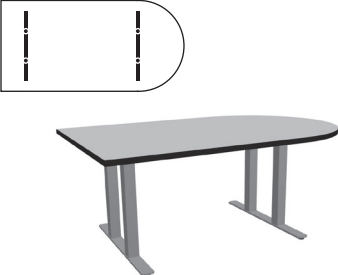
D-shaped with TT-bases	Top Size	Base	Model Number	3P	3K	3W
	42 x 60	Static	74D4260TT32	\$2,561	\$3,015	\$2,897
		Electric	74D4260TT32EH	6,830	7,284	7,166
	42 x 72	Static	74D4272TT32	2,561	3,015	2,926
		Electric	74D4272TT32EH	6,830	7,284	7,195
	42 x 84	Static	74D4284TT32	2,646	3,100	3,040
		Electric	74D4284TT32EH	6,915	7,369	7,308
	42 x 90 *	Static	74D4290TT32	2,727	3,214	3,144
		Electric	74D4290TT32EH	6,996	7,483	7,412
	42 x 96 *	Static	74D4296TT32	2,808	3,328	3,247
		Electric	74D4296TT32EH	7,077	7,597	7,516
	48 x 60	Static	74D4860TT36	2,582	3,041	2,931
		Electric	74D4860TT36EH	9,579	10,038	9,927
48 x 72	Static	74D4872TT36	2,582	3,041	2,960	
	Electric	74D4872TT36EH	9,579	10,038	9,956	
48 x 84	Static	74D4884TT36	2,667	3,126	3,073	
	Electric	74D4884TT36EH	9,663	10,123	10,070	
48 x 90 *	Static	74D4890TT36	2,789	3,297	3,222	
	Electric	74D4890TT36EH	9,785	10,294	10,218	
48 x 96 *	Static	74D4896TT36	2,831	3,356	3,283	
	Electric	74D4896TT36EH	9,827	10,352	10,279	





Half Round with T-bases	Top Size	Base	Model Number	3P	3K	3W
	24 x 48	Static	74HR2448T18	\$ 923	\$ 1,056	\$ 1,104
		Nesting	74HR2448T18NE	1,743	1,875	1,924
		Ratchet	74HR2448T18RA	1,459	1,592	1,640
		Electric	74HR2448T18EH	3,144	3,277	3,325
	30 x 60	Static	74HR3060T22	1,124	1,330	1,361
		Nesting	74HR3060T22NE	1,944	2,150	2,181
		Ratchet	74HR3060T22RA	1,661	1,866	1,897
		Count Bal	74HR3060T22BL	2,936	3,142	3,173
		Electric	74HR3060T22EH	3,341	3,547	3,577
	36 x 72	Static	74HR3672T26	1,366	1,660	1,661
		Nesting	74HR3672T26NE	2,326	2,620	2,621
		Ratchet	74HR3672T26RA	1,903	2,198	2,198
		Count Bal	74HR3672T26BL	3,194	3,488	3,489
		Electric	74HR3672T26EH	3,582	3,876	3,877



\* \$200 NET surcharge per order for oversized pallet

For VertiGo table options, please reference pages 182-183.

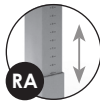
Top Size	Base	Model Number	3P	3K	3W	Trapezoid with T-bases
24 x 48	Static	74TZ2448T18	\$ 912	\$1,040	\$1,092	     
	Ratchet	74TZ2448T18RA	1,448	1,576	1,628	
	Crank	74TZ2448T18CR	1,614	1,742	1,794	
	Electric	74TZ2448T18EH	3,133	3,261	3,313	
24 x 72	Static	74TZ2472T18	1,120	1,332	1,395	
	Nesting	74TZ2472T18NE	1,940	2,152	2,215	
	Ratchet	74TZ2472T18RA	1,656	1,868	1,931	
	Crank	74TZ2472T18CR	1,822	2,034	2,097	
	Count Bal	74TZ2472T18BL	2,951	3,163	3,226	
	Electric	74TZ2472T18EH	3,341	3,553	3,616	
30 x 60	Static	74TZ3060T22	1,070	1,254	1,301	
	Nesting	74TZ3060T22NE	1,890	2,074	2,121	
	Ratchet	74TZ3060T22RA	1,606	1,790	1,837	
	Crank	74TZ3060T22CR	1,769	1,953	1,999	
	Count Bal	74TZ3060T22BL	2,900	3,084	3,130	
	Electric	74TZ3060T22EH	3,287	3,471	3,517	
36 x 72	Static	74TZ3672T26	1,337	1,620	1,629	
	Nesting	74TZ3672T26NE	2,297	2,580	2,589	
	Ratchet	74TZ3672T26RA	1,874	2,157	2,166	
	Crank	74TZ3672T26CR	2,034	2,316	2,326	
	Count Bal	74TZ3672T26BL	3,164	3,447	3,457	
	Electric	74TZ3672T26EH	3,552	3,835	3,845	

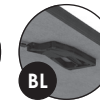
Top Size	Base	Model Number	3P	3K	3W	Squire with X-base
24 x 24	Static	74SL24X22	\$ 1,018	\$ 1,161	\$ 1,169	   
	Ratchet	74SL24X22RA	1,215	1,358	1,366	
	Short Bal	74SL24X22BLS	1,504	1,647	1,655	
30 x 30	Static	74SL30X26	1,099	1,267	1,285	
	Ratchet	74SL30X26RA	1,296	1,464	1,482	
	Short Bal	74SL30X26BLS	1,581	1,749	1,767	
36 x 36	Static	74SL36X32	1,187	1,382	1,408	
	Short Bal	74SL36X32BLS	1,668	1,863	1,889	
	Count Bal	74SL36X32BL	1,668	1,863	1,889	
42 x 42	Static	74SL42X36	1,281	1,507	1,539	
	Short Bal	74SL42X36BLS	1,759	1,985	2,017	
	Count Bal	74SL42X36BL	1,759	1,985	2,017	

For VertiGo table options, please reference pages 182-183.