

table

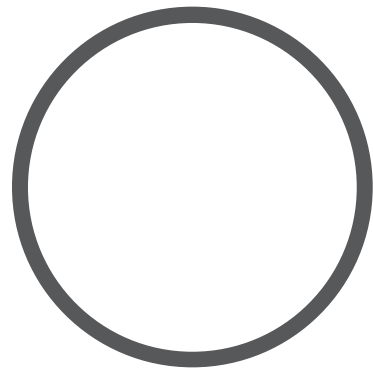

99 surge
price list

Effective January 1, 2025

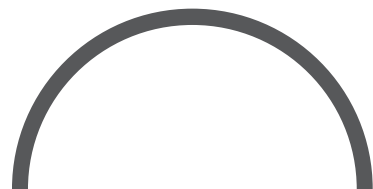



Surge series tables are sleek, stylish, and versatile. With height adjustable options and a variety of top shapes and sizes, Surge provides a sophisticated solution for any space.

Surge Base Styles

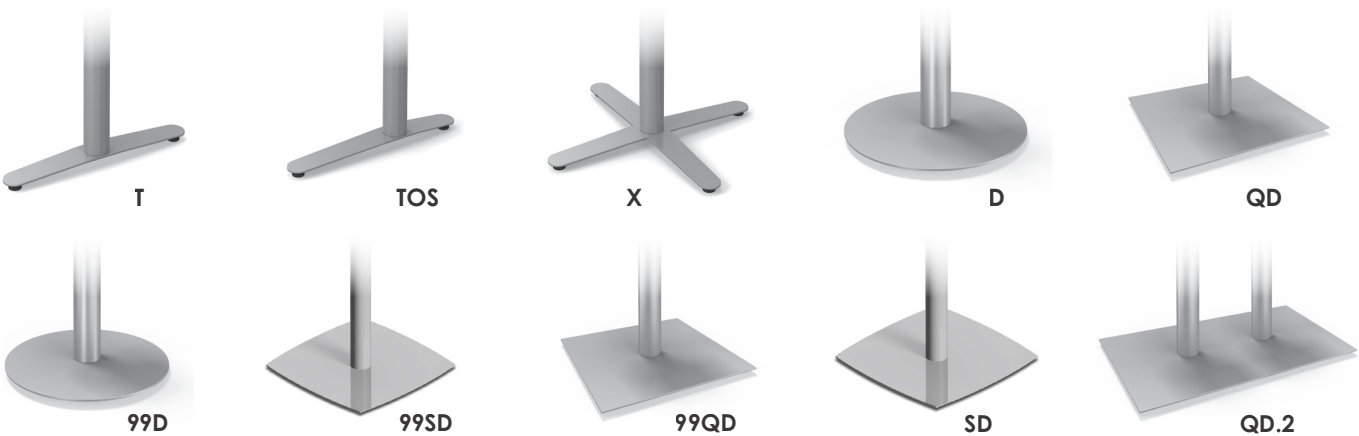

Surge Options

surge

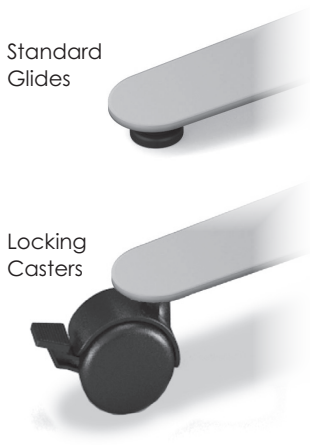

- LC Locking Casters**
can be added to any table for \$111 per set of four.
- FD Folding Bases**
priced accordingly with standard glides.
- NE Nesting Tables**
priced accordingly with locking casters.
- FT Flip Tops**
available on disc and X-based tables for \$138. Not available on counterbalanced tables.
- OS Offset T-bases**
available for \$39 per table.
- CH Chrome Finish**
is not available on Surge tables.
- WM Wire Management**
Built-in wire management is not available on Surge tables.
- WMLC Wire Management Leg Covers**
snap onto any round column and are \$50 each for 2" and \$79 each for 3".
- SH Special Height**
can be added to any table:
+ \$72 per column for heights > 29"
+ \$39 per column for heights < 29"
Special height tables with tops larger than 36x72" must be custom quoted.
- FR Footring**
is not available on Surge tables.
- PB Powerbox Mounting Plate**
is available on disc and X-bases for \$100.

Surge Height Adjustable Options

EH Electric Height is available on T-bases and is available in two finishes:

- 37 Satin Silver
- 57 Jet

BL Counterbalanced and Short Balanced are available on disc and X-bases. Available height adjustable finishes can be found on page 9.

Surge Top Shapes



Rectangle p.200



Boat p.203



Racetrack p.204



Elliptical p.205



Squircle p.206



Square p.206



Round p.207



D-shaped p.208



Half Round p.210



Trapezoid p.210

Surge Top Options

QG Quick-Connect Ganging Brackets can be added to any table for \$45 (includes 4 connectors per table).

RC 3" Radius Corners can be added to any table for \$61.

GR Grommets can be added to any table for \$45 each. To see specific locations, see page 233.

Surge Edge Options

(corresponds with 3 columns of pricing)

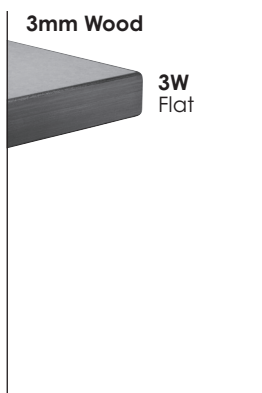
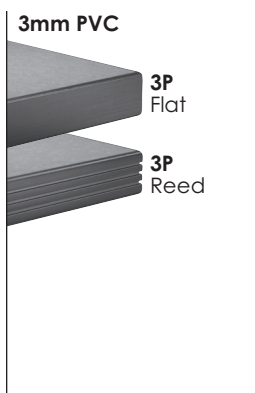

surge

Electric Height Adjustable T-bases

Electric height adjustability gives you the ability to go from sitting to standing height at the push of a button. With a weight capacity of 225 lbs. per table, Surge is strong enough to work in many different applications.

The standard memory keypad will remember your four favorite heights.

Want to use Surge on the go? Simply add 2" to each vertical measurement to account for locking casters.

To specify:
All available electric models are priced in the following pages. They are denoted by the "EH" at the end of the model number.

Example:
99TC2460T22EH-3P
24x60" **electric height** table
\$2,547 List Price

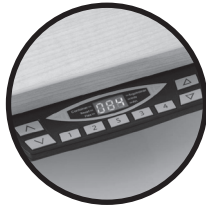

Standard
Memory
Keypad

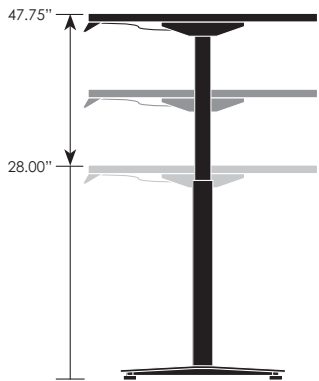

T-bases

Counterbalanced & Short Balanced Height Adjustable Disc & X-bases

Counterbalanced tables go from seated-to-standing height, while the short balanced goes from coffee-to-seated height. Available on tables using single column disc or X-bases, these tables are easy to adjust. Simply squeeze the small handle underneath and gently move the top to your desired height. It's that easy.

Want to use Surge on the go? Simply add 2" to each vertical measurement to account for the added height of locking casters.

To specify:
All available counterbalanced models are priced in the following pages. They are denoted by the "BL" or "BLS" (for short balanced) at the end of the model number.

Example:
99RD36X30BL-3P
36" round **counterbalanced** table
\$1,925 List Price

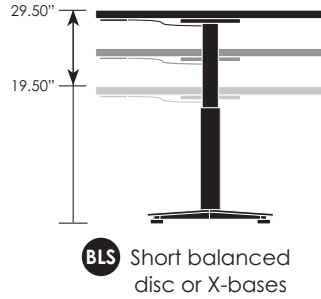
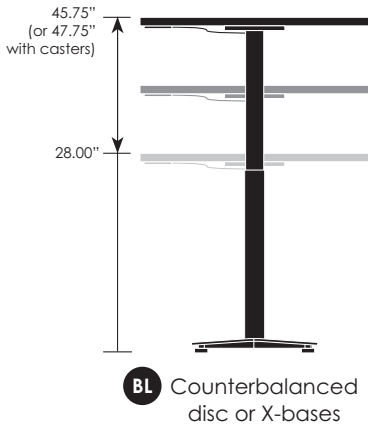
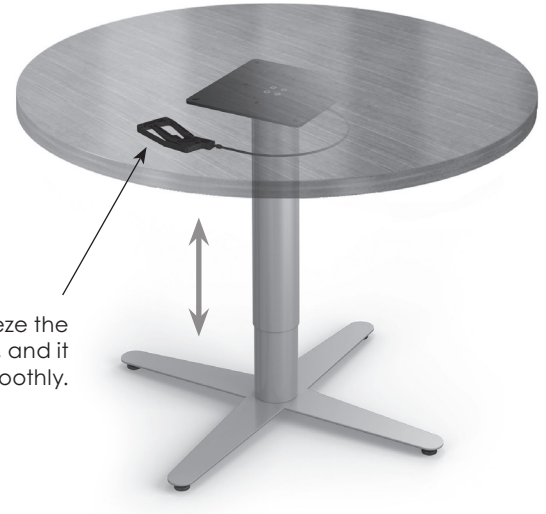

Counterbalanced Height Ranges:

Smaller Surge tables using smaller bases have a 17.75" range, while the larger tables using larger bases have an extended range of 19.75". See the list below for ranges of used on specific top shapes and sizes. All counterbalanced tables have a starting height of 28".

Square	Range	Max Ht.	Round	Range	Max Ht.
36" SQ	19.75"	47.75"	36" RD-X	17.75"	45.75"
42" SQ			36" BU		
			36" RD-D	19.75"	47.75"
			42" RD		
			48" RD		

Rectangular with T-bases	Top Size	Base	Model Number	3P	3K	3W
	24 x 36	Static	99TC2436T22	\$ 849	\$ 923	\$ 1,011
		Nesting	99TC2436T22NE	1,668	1,743	1,831
		Electric	99TC2436T22EH	2,459	2,534	2,621
	24 x 48	Static	99TC2448T22	909	1,007	1,106
		Folding	99TC2448T22FD	1,224	1,323	1,422
		Nesting	99TC2448T22NE	1,729	1,827	1,926
		Electric	99TC2448T22EH	2,519	2,618	2,716
	24 x 60	Static	99TC2460T22	937	1,047	1,165
		Folding	99TC2460T22FD	1,265	1,375	1,494
		Nesting	99TC2460T22NE	1,757	1,866	1,985
		Electric	99TC2460T22EH	2,547	2,657	2,776
	24 x 72	Static	99TC2472T22	989	1,119	1,251
Folding		99TC2472T22FD	1,317	1,448	1,580	
Nesting		99TC2472T22NE	2,049	2,180	2,312	
Electric		99TC2472T22EH	2,599	2,730	2,862	
24 x 84	Static	99TC2484T22	1,175	1,346	1,476	
	Folding	99TC2484T22FD	1,418	1,589	1,720	
	Nesting	99TC2484T22NE	2,150	2,321	2,452	
24 x 90 *	Static	99TC2490T22	1,235	1,430	1,557	
	Folding	99TC2490T22FD	1,478	1,673	1,800	
	Nesting	99TC2490T22NE	2,210	2,406	2,532	
24 x 96 *	Static	99TC2496T22	1,235	1,430	1,571	
	Folding	99TC2496T22FD	1,478	1,673	1,815	
	Nesting	99TC2496T22NE	2,210	2,406	2,547	
30 x 36	Static	99TC3036T26	902	995	1,084	
	Nesting	99TC3036T26NE	1,722	1,815	1,904	
	Electric	99TC3036T26EH	2,513	2,606	2,695	
30 x 48	Static	99TC3048T26	977	1,099	1,194	
	Folding	99TC3048T26FD	1,293	1,415	1,510	
	Nesting	99TC3048T26NE	1,797	1,919	2,014	
	Electric	99TC3048T26EH	2,588	2,710	2,805	
30 x 60	Static	99TC3060T26	1,000	1,132	1,249	
	Folding	99TC3060T26FD	1,329	1,460	1,577	
	Nesting	99TC3060T26NE	1,820	1,952	2,069	
	Electric	99TC3060T26EH	2,611	2,743	2,860	
30 x 72	Static	99TC3072T26	1,059	1,213	1,342	
	Folding	99TC3072T26FD	1,387	1,542	1,670	
	Nesting	99TC3072T26NE	2,119	2,274	2,402	
	Electric	99TC3072T26EH	2,670	2,824	2,953	

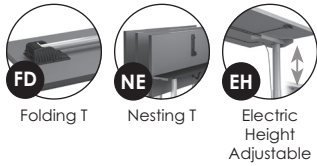

surge

* \$200 NET surcharge per order for oversized pallet

For Surge table options, please reference pages 202-205.

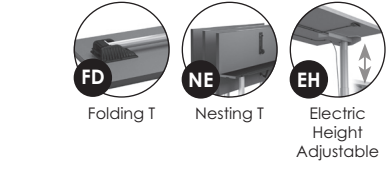
Top Size	Base	Model Number	3P	3K	3W	Rectangular with T-bases	
30 x 84	Static	99TC3084T26	\$ 1,286	\$ 1,498	\$ 1,612		
	Folding	99TC3084T26FD	1,529	1,741	1,855		
	Nesting	99TC3084T26NE	2,261	2,473	2,587		
30 x 90 *	Static	99TC3090T26	1,361	1,602	1,708		
	Folding	99TC3090T26FD	1,604	1,846	1,952		
30 x 96 *	Static	99TC3096T26	1,361	1,602	1,723		
	Folding	99TC3096T26FD	1,604	1,846	1,966		
36 x 48	Static	99TC3648T26	1,036	1,182	1,274		
	Folding	99TC3648T26FD	1,352	1,497	1,589		
	Nesting	99TC3648T26NE	1,996	2,142	2,234		
	Electric	99TC3648T26EH	2,647	2,793	2,885		
36 x 60	Static	99TC3660T26	1,125	1,306	1,400		
	Folding	99TC3660T26FD	1,454	1,635	1,729		
	Nesting	99TC3660T26NE	2,159	2,340	2,434		
	Electric	99TC3660T26EH	2,736	2,917	3,011		
36 x 72	Static	99TC3672T26	1,181	1,385	1,491		
	Folding	99TC3672T26FD	1,510	1,714	1,819		
	Nesting	99TC3672T26NE	2,242	2,446	2,551		
	Electric	99TC3672T26EH	2,792	2,996	3,102		
36 x 84	Static	99TC3684T26	1,388	1,641	1,739		
	Folding	99TC3684T26FD	1,632	1,884	1,982		
36 x 90 *	Static	99TC3690T26	1,476	1,764	1,850		
	Folding	99TC3690T26FD	1,720	2,007	2,093		
36 x 96 *	Static	99TC3696T26	1,476	1,764	1,864		
	Folding	99TC3696T26FD	1,720	2,007	2,108		

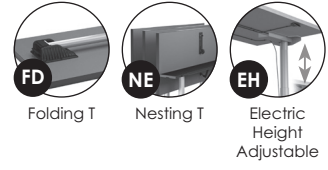

* \$200 NET surcharge per order for oversized pallet

For Surge table options, please reference pages 202-205.

Rectangular with 2 Thin Disc Bases

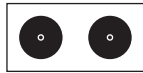

Top Size	Base	Model Number	3P	3K	3W
24 x 60	Static	99TC2460D20	\$ 1,499	\$ 1,609	\$ 1,728
24 x 72	Static	99TC2472D20	1,551	1,682	1,814
24 x 84	Static	99TC2484D20	1,652	1,823	1,953
24 x 90 *	Static	99TC2490D20	1,797	1,992	2,119
24 x 96 *	Static	99TC2496D20	1,797	1,992	2,133
30 x 60	Static	99TC3060D20	1,553	1,685	1,802
30 x 72	Static	99TC3072D20	1,612	1,766	1,895
30 x 84	Static	99TC3084D20	1,754	1,966	2,080
30 x 90 *	Static	99TC3090D20	1,914	2,155	2,261
30 x 96 *	Static	99TC3096D20	1,914	2,155	2,276
36 x 72	Static	99TC3672D24	1,812	2,016	2,122
36 x 84	Static	99TC3684D24	1,974	2,227	2,325
36 x 90 *	Static	99TC3690D24	2,147	2,435	2,521
36 x 96 *	Static	99TC3696D24	2,147	2,435	2,535
42 x 72	Static	99TC4272D32	2,237	2,492	2,574
42 x 84	Static	99TC4284D32	2,339	2,634	2,715
42 x 90 *	Static	99TC4290D32	2,522	2,857	2,922
42 x 96 *	Static	99TC4296D32	2,522	2,857	2,937

⊗ → 2 thin disc bases: CH N/A SH +143

Rectangle with 2-column Disc Base



Top Size	Base	Model Number	3P	3K	3W
24 x 36	Static	99TC2436QD2032.2	\$ 1,390	\$ 1,465	\$ 1,553
24 x 48	Static	99TC2448QD2032.2	1,450	1,549	1,648
30 x 36	Static	99TC3036QD2032.2	1,435	1,527	1,616
30 x 48	Static	99TC3048QD2032.2	1,509	1,632	1,727
36 x 48	Static	99TC3648QD2032.2	1,568	1,714	1,806

Rectangular with 3 Thin Disc Bases

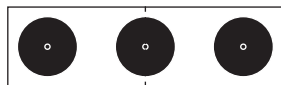

Top Size	Base	Model Number	3P	3K	3W
42 x 120	Static	99TC42120D32(3)-TJ	\$3,649	\$4,146	\$4,161
42 x 144	Static	99TC42144D32(3)-TJ	3,853	4,431	4,443

⊗ → 3 thin disc bases: CH N/A SH +215

surge

* \$200 NET surcharge per order for oversized pallet

For Surge table options, please reference pages 202-205.

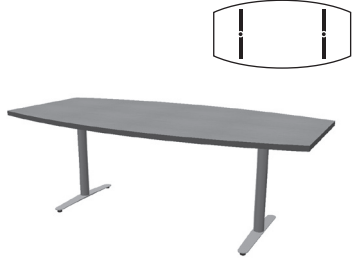
Top Size	Base	Model Number	3P	3K	3W	Boat-shaped with T-bases
30 x 42 x 84	Static	99BT3084T26	\$ 1,799	\$ 2,200	\$ 2,158	
30 x 42 x 90 *	Static	99BT3090T26	1,941	2,399	2,329	
30 x 42 x 96 *	Static	99BT3096T26	1,941	2,399	2,343	

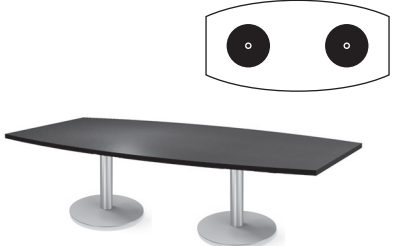
Top Size	Base	Model Number	3P	3K	3W	Boat-shaped with 2 Thin Disc Bases
30 x 42 x 84	Static	99BT3084D24	\$ 2,345	\$ 2,746	\$ 2,704	
30 x 42 x 90 *	Static	99BT3090D24	2,572	3,030	2,960	
30 x 42 x 96 *	Static	99BT3096D24	2,572	3,030	2,974	
36 x 48 x 84	Static	99BT3684D32	2,744	3,201	3,125	
36 x 48 x 90 *	Static	99BT3690D32	2,990	3,512	3,402	
36 x 48 x 96 *	Static	99BT3696D32	2,990	3,512	3,416	



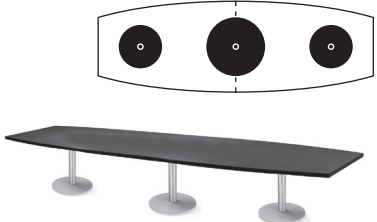

CH SH ← ⊗
 N/A +143 2 thin disc bases:



Top Size	Base	Model Number	3P	3K	3W	Boat-shaped with 3 Thin Disc Bases
36 x 48 x 120	Static	99BT36120D243224-TJ	\$ 3,978	\$ 4,710	\$ 4,514	
36 x 48 x 144	Static	99BT36144D243224-TJ	4,302	5,163	4,928	

CH SH ← ⊗
 N/A +215 3 thin disc bases:

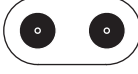

* \$200 NET surcharge per order for oversized pallet

For Surge table options, please reference pages 202-205.

Racetrack with T-bases	Top Size	Base	Model Number	3P	3K	3W
  <div style="display: flex; justify-content: space-around; margin-top: 10px;"> <div style="text-align: center;">  <p>FD Folding T</p> </div> <div style="text-align: center;">  <p>NE Nesting T</p> </div> <div style="text-align: center;">  <p>EH Electric Height Adjustable</p> </div> </div>	36 x 60	Static	99RT3660T26	\$ 1,412	\$ 1,708	\$ 1,679
		Nesting	99RT3660T26NE	2,372	2,668	2,639
		Electric	99RT3660T26EH	3,013	3,309	3,280
	36 x 72	Static	99RT3672T26	1,412	1,708	1,707
		Folding	99RT3672T26FD	1,740	2,036	2,036
		Nesting	99RT3672T26NE	2,446	2,742	2,741
		Electric	99RT3672T26EH	3,013	3,309	3,309
	36 x 84	Static	99RT3684T26	1,756	2,155	2,106
		Folding	99RT3684T26FD	2,039	2,439	2,390
	36 x 90 *	Static	99RT3690T26	1,941	2,399	2,320
		Folding	99RT3690T26FD	2,185	2,643	2,564
	36 x 96 *	Static	99RT3696T26	1,941	2,399	2,335
Folding		99RT3696T26FD	2,185	2,643	2,578	

Racetrack with 2 Thin Disc Bases	Top Size	Base	Model Number	3P	3K	3W
 	36 x 72	Static	99RT3672D20	\$ 1,965	\$ 2,261	\$ 2,260
	36 x 84	Static	99RT3684D20	2,264	2,663	2,614
	36 x 90 *	Static	99RT3690D20	2,494	2,952	2,873
	36 x 96 *	Static	99RT3696D20	2,494	2,952	2,888
	42 x 84	Static	99RT4284D24	2,342	2,741	2,700
	42 x 90 *	Static	99RT4290D24	2,572	3,030	2,960
	42 x 96 *	Static	99RT4296D24	2,572	3,030	2,974
	48 x 84	Static	99RT4884D32	2,905	3,427	3,303
	48 x 90 *	Static	99RT4890D32	2,990	3,512	3,402
	48 x 96 *	Static	99RT4896D32	2,990	3,512	3,416

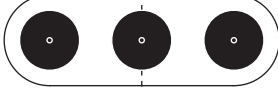
⊗ → **CH** **SH**
2 thin disc bases: N/A +143

Racetrack with 3 Thin Disc Bases	Top Size	Base	Model Number	3P	3K	3W
 	42 x 120	Static	99RT42120D24(3)-TJ	\$ 3,831	\$ 4,556	\$ 4,358
	42 x 144	Static	99RT42144D24(3)-TJ	4,152	5,005	4,767
	48 x 120	Static	99RT48120D32(3)-TJ	4,236	4,969	4,772
	48 x 144	Static	99RT48144D32(3)-TJ	4,560	5,422	5,186

⊗ → **CH** **SH**
3 thin disc bases: N/A +215

* \$200 NET surcharge per order for oversized pallet

For Surge table options, please reference pages 202-205.

Top Size	Base	Model Number	3P	3K	3W	Elliptical with T-bases
30 x 54	Static	99EL3054T22	\$ 1,130	\$ 1,317	\$ 1,335	
	Electric	99EL3054T22EH	2,740	2,927	2,945	
30 x 60	Static	99EL3060T22	1,179	1,386	1,400	
	Electric	99EL3060T22EH	2,790	2,996	3,011	
36 x 60	Static	99EL3660T26	1,293	1,541	1,536	
	Electric	99EL3660T26EH	2,904	3,152	3,147	
36 x 72	Static	99EL3672T26	1,412	1,708	1,689	
	Electric	99EL3672T26EH	3,023	3,319	3,300	
36 x 84	Static	99EL3684T26	1,661	2,007	1,973	
36 x 90 *	Static	99EL3690T26	1,780	2,173	2,115	
36 x 96 *	Static	99EL3696T26	1,780	2,173	2,126	



Top Size	Base	Model Number	3P	3K	3W	Elliptical with 2 Thin Disc Bases
36 x 72	Static	99EL3672D20	\$ 1,965	\$ 2,261	\$ 2,242	
36 x 84	Static	99EL3684D20	2,129	2,475	2,441	
36 x 90 *	Static	99EL3690D20	2,333	2,726	2,668	
36 x 96 *	Static	99EL3696D20	2,333	2,726	2,679	
42 x 72	Static	99EL4272D24	2,207	2,553	2,508	
42 x 84	Static	99EL4284D24	2,342	2,741	2,679	
42 x 90 *	Static	99EL4290D24	2,575	3,034	2,938	
42 x 96 *	Static	99EL4296D24	2,575	3,034	2,949	
48 x 84	Static	99EL4884D32	2,906	3,428	3,285	
48 x 90 *	Static	99EL4890D32	2,991	3,513	3,381	
48 x 96 *	Static	99EL4896D32	2,991	3,513	3,392	

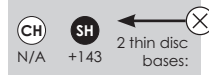

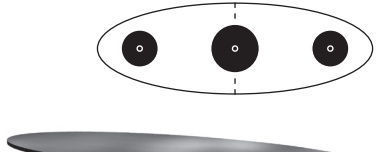

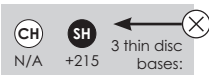
Top Size	Base	Model Number	3P	3K	3W	Elliptical with 3 Thin Disc Bases
42 x 120	Static	99EL42120D24(3)-TJ	\$ 3,831	\$ 4,556	\$ 4,317	
42 x 144	Static	99EL42144D24(3)-TJ	4,152	5,005	4,715	
48 x 120	Static	99EL48120D32(3)-TJ	4,236	4,969	4,735	
48 x 144	Static	99EL48144D32(3)-TJ	4,560	5,422	5,137	









* \$200 NET surcharge per order for oversized pallet

For Surge table options, please reference pages 202-205.





surge





Squircle with X-base	Top Size	Base	Model Number	3P	3K	3W
  Short Balanced Ht. Adjustable  Counter-balanced Ht. Adjustable	24 x 24	Static	99SL24X22	\$ 921	\$ 1,064	\$ 1,071
		Short Bal	99SL24X22BLS	1,495	1,639	1,646
	30 x 30	Static	99SL30X26	987	1,155	1,173
		Short Bal	99SL30X26BLS	1,567	1,734	1,752
	36 x 36	Static	99SL36X30	1,148	1,344	1,369
		Short Bal	99SL36X30BLS	2,058	2,254	2,279
		Count Bal	99SL36X30BL	2,058	2,254	2,279
	42 x 42	Static	99SL42X30	1,223	1,449	1,481
		Short Bal	99SL42X30BLS	2,133	2,359	2,391
		Count Bal	99SL42X30BL	2,133	2,359	2,391





Squircle with Thin Squircle Disc Base	Top Size	Base	Model Number	3P	3K	3W
  Short Balanced Ht. Adjustable  Counter-balanced Ht. Adjustable 	24 x 24	Static	99SL24SD16	\$ 1,033	\$ 1,176	\$ 1,184
		Short Bal	99SL24SD16BLS	1,681	1,825	1,832
	30 x 30	Static	99SL30SD16	1,095	1,263	1,280
		Short Bal	99SL30SD16BLS	1,743	1,911	1,929
	36 x 36	Static	99SL36SD20	1,200	1,396	1,422
		Short Bal	99SL36SD20BLS	1,852	2,048	2,073
		Count Bal	99SL36SD20BL	1,852	2,048	2,073
	42 x 42	Static	99SL42SD26	1,408	1,634	1,666
		Short Bal	99SL42SD26BLS	2,049	2,275	2,307
		Count Bal	99SL42SD26BL	2,049	2,275	2,307

Square with X-base	Top Size	Base	Model Number	3P	3K	3W
  Short Balanced Ht. Adjustable  Counter-balanced Ht. Adjustable	24 x 24	Static	99SQ2424X22	\$ 688	\$ 739	\$ 816
		Short Bal	99SQ2424X22BLS	1,263	1,314	1,391
	30 x 30	Static	99SQ3030X26	761	838	924
		Short Bal	99SQ3030X26BLS	1,340	1,417	1,503
	36 x 36	Static	99SQ3636X30	935	1,045	1,135
		Short Bal	99SQ3636X30BLS	1,845	1,955	2,045
		Count Bal	99SQ3636X30BL	1,845	1,955	2,045
	42 x 42	Static	99SQ4242X34	1,052	1,201	1,291
		Short Bal	99SQ4242X34BLS	1,962	2,111	2,201
		Count Bal	99SQ4242X34BL	1,962	2,111	2,201



For Surge table options, please reference pages 202-205.

Top Size	Base	Model Number	3P	3K	3W	Square with Thin Square Disc Base
24 x 24	Static	99SQ2424QD16	\$ 798	\$ 848	\$ 926	    <p>Short Balanced Ht. Adjustable</p> <p>Counter-balanced Ht. Adjustable</p> 
	Short Bal	99SQ2424QD16BLS	1,449	1,500	1,577	
30 x 30	Static	99SQ3030QD16	866	943	1,029	
	Short Bal	99SQ3030QD16BLS	1,517	1,594	1,680	
36 x 36	Static	99SQ3636QD20	986	1,097	1,186	
	Short Bal	99SQ3636QD20BLS	1,639	1,749	1,839	
	Count Bal	99SQ3636QD20BL	1,639	1,749	1,839	
42 x 42	Static	99SQ4242QD26	1,212	1,360	1,450	
	Short Bal	99SQ4242QD26BLS	1,857	2,005	2,095	
	Count Bal	99SQ4242QD26BL	1,857	2,005	2,095	

Top Size	Base	Model Number	3P	3K	3W	Round with X-base
24 x 24	Static	99RD24X22	\$ 730	\$ 797	\$ 837	    <p>Short Balanced Ht. Adjustable</p> <p>Counter-balanced Ht. Adjustable</p>
	Short Bal	99RD24X22BLS	1,305	1,372	1,412	
30 x 30	Static	99RD30X26	826	930	965	
	Short Bal	99RD30X26BLS	1,406	1,509	1,545	
36 x 36	Static	99RD36X30	1,015	1,158	1,186	
	Short Bal	99RD36X30BLS	1,925	2,068	2,096	
	Count Bal	99RD36X30BL	1,925	2,068	2,096	
42 x 42	Static	99RD42X30	1,143	1,337	1,350	
	Short Bal	99RD42X30BLS	2,053	2,247	2,260	
	Count Bal	99RD42X30BL	2,053	2,247	2,260	
48 x 48	Static	99RD48X34	1,201	1,409	1,433	
	Short Bal	99RD48X34BLS	2,111	2,319	2,343	
	Count Bal	99RD48X34BL	2,111	2,319	2,343	

Top Size	Base	Model Number	3P	3K	3W	Round with thin Disc Base
24 x 24	Static	99RD24D20	\$ 840	\$ 907	\$ 947	    <p>Short Balanced Ht. Adjustable</p> <p>Counter-balanced Ht. Adjustable</p> 
	Short Bal	99RD24D20BLS	1,434	1,501	1,541	
30 x 30	Static	99RD30D20	931	1,035	1,070	
	Short Bal	99RD30D20BLS	1,525	1,629	1,664	
36 x 36	Static	99RD36D20	1,028	1,171	1,199	
	Short Bal	99RD36D20BLS	1,622	1,764	1,793	
	Count Bal	99RD36D20BL	1,622	1,764	1,793	
42 x 42	Static	99RD42D24	1,195	1,389	1,402	
	Short Bal	99RD42D24BLS	2,092	2,286	2,299	
	Count Bal	99RD42D24BL	2,092	2,286	2,299	
48 x 48	Static	99RD48D32	1,360	1,568	1,593	
	Short Bal	99RD48D32BLS	2,251	2,459	2,484	
	Count Bal	99RD48D32BL	2,251	2,459	2,484	

For Surge table options, please reference pages 202-205.

D-shaped with T-bases	Top Size	Base	Model Number	3P	3K	3W
 	24 x 36	Static	99D2436T22	\$ 909	\$ 1,007	\$ 1,065
		Electric	99D2436T22EH	2,519	2,617	2,675
	24 x 48	Static	99D2448T22	991	1,122	1,183
		Electric	99D2448T22EH	2,601	2,732	2,794
	24 x 60	Static	99D2460T22	1,073	1,237	1,302
		Electric	99D2460T22EH	2,683	2,847	2,913
	24 x 72	Static	99D2472T22	1,155	1,351	1,421
		Electric	99D2472T22EH	2,765	2,962	3,032
 Electric Height Adjustable	24 x 84	Static	99D2484T22	1,322	1,551	1,625
	24 x 90 *	Static	99D2490T22	1,363	1,609	1,685
	24 x 96 *	Static	99D2496T22	1,404	1,666	1,744
	30 x 48	Static	99D3048T26	1,082	1,246	1,294
		Electric	99D3048T26EH	2,693	2,857	2,905
	30 x 60	Static	99D3060T26	1,185	1,390	1,436
		Electric	99D3060T26EH	2,795	3,001	3,047
	30 x 72	Static	99D3072T26	1,287	1,533	1,577
		Electric	99D3072T26EH	2,898	3,144	3,188
	30 x 84	Static	99D3084T26	1,474	1,762	1,804
	30 x 90 *	Static	99D3090T26	1,526	1,833	1,875
	30 x 96 *	Static	99D3096T26	1,577	1,905	1,945
	36 x 48	Static	99D3648T26	1,164	1,361	1,396
		Electric	99D3648T26EH	2,775	2,972	3,007
	36 x 60	Static	99D3660T26	1,287	1,533	1,560
		Electric	99D3660T26EH	2,898	3,144	3,171
	36 x 72	Static	99D3672T26	1,410	1,705	1,724
		Electric	99D3672T26EH	3,021	3,316	3,335
	36 x 84	Static	99D3684T26	1,618	1,962	1,973
	36 x 90 *	Static	99D3690T26	1,680	2,049	2,055
	36 x 96 *	Static	99D3696T26	1,741	2,135	2,137

surge

* \$200 NET surcharge per order for oversized pallet

For Surge table options, please reference pages 202-205.

Top Size	Base	Model Number	3P	3K	3W	D-shaped with 2 Disc Bases
24 x 60	Static	99D2460D20	\$ 1,635	\$ 1,799	\$ 1,865	
24 x 72	Static	99D2472D20	1,717	1,914	1,984	
24 x 84	Static	99D2484D20	1,884	2,113	2,188	
24 x 90 *	Static	99D2490D20	1,925	2,171	2,247	
24 x 96 *	Static	99D2496D20	1,966	2,228	2,307	
30 x 60	Static	99D3060D20	1,737	1,943	1,989	
30 x 72	Static	99D3072D20	1,840	2,086	2,130	
30 x 84	Static	99D3084D20	2,027	2,315	2,357	
30 x 90 *	Static	99D3090D20	2,079	2,386	2,428	
30 x 96 *	Static	99D3096D20	2,130	2,458	2,498	
36 x 72	Static	99D3672D24	2,041	2,336	2,355	
36 x 84	Static	99D3684D24	2,289	2,633	2,644	
36 x 90 *	Static	99D3690D24	2,350	2,720	2,726	
36 x 96 *	Static	99D3696D24	2,412	2,806	2,808	
42 x 72	Static	99D4272D32	2,737	3,192	3,102	
42 x 84	Static	99D4284D32	2,822	3,277	3,216	
42 x 90 *	Static	99D4290D32	2,904	3,391	3,320	
42 x 96 *	Static	99D4296D32	2,985	3,504	3,424	

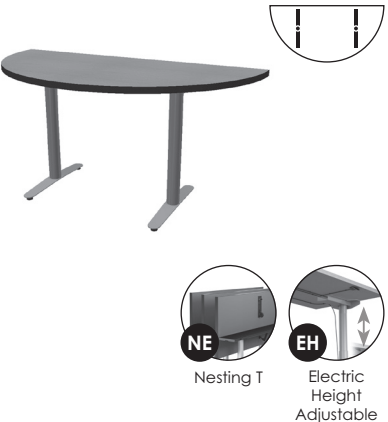
Top Size	Base	Model Number	3P	3K	3W	Half Round with T-bases
30 x 60	Static	99HR3060T22	\$ 1,177	\$ 1,383	\$ 1,413	
	Nesting	99HR3060T22NE	1,997	2,203	2,233	
	Electric	99HR3060T22EH	2,787	2,993	3,024	
36 x 72	Static	99HR3672T26	1,408	1,703	1,704	
	Nesting	99HR3672T26NE	2,368	2,663	2,664	
	Electric	99HR3672T26EH	3,019	3,314	3,315	

* \$200 NET surcharge per order for oversized pallet

For Surge table options, please reference pages 202-205.

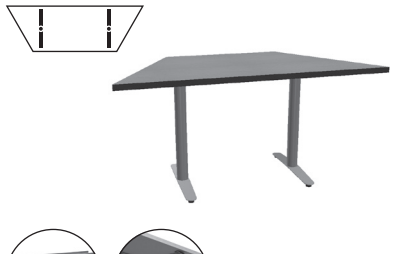
Trapezoid with T-bases	Top Size	Base	Model Number	3P	3K	3W
	30 x 60	Static	99TZ3060T22	\$ 1,123	\$ 1,307	\$ 1,353
		Nesting	99TZ3060T22NE	1,942	2,126	2,173
		Electric	99TZ3060T22EH	2,733	2,917	2,964
	36 x 72	Static	99TZ3672T26	1,379	1,662	1,672
		Nesting	99TZ3672T26NE	2,339	2,622	2,632
		Electric	99TZ3672T26EH	2,980	3,263	3,273

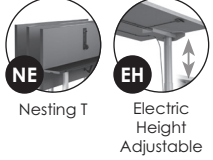

For Surge table options, please reference pages 202-205.