







table

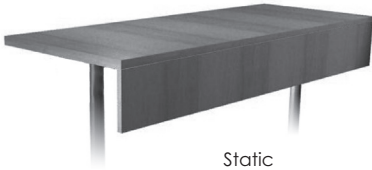

AC accessories
price list

Effective January 1, 2025



Laminate Modesty Panels	Top Size	Base	Model Number	Hardware	3P	3W
	10 x 36	Static	MP1036	02 Black	\$ 166	\$ 286
		Nesting	MP1036NE	02 Black	257	376
	10 x 48	Static	MP1048	02 Black	196	347
		Nesting	MP1048NE	02 Black	286	438
	10 x 60	Static	MP1060	02 Black	225	408
		Folding	MP1060FD	02 Black	386	569
		Nesting	MP1060NE	02 Black	315	499
	10 x 72	Static	MP1072	02 Black	269	484
		Folding	MP1072FD	02 Black	415	630
		Nesting	MP1072NE	02 Black	345	560
	10 x 84	Static	MP1084	02 Black	299	545
		Folding	MP1084FD	02 Black	540	786
		Nesting	MP1084NE	02 Black	434	681
	10 x 90	Static	MP1090	02 Black	343	607
		Folding	MP1090FD	02 Black	569	833
		Nesting	MP1090NE	02 Black	464	728
	10 x 96 *	Static	MP1096	02 Black	343	621
		Folding	MP1096FD	02 Black	569	847
		Nesting	MP1096NE	02 Black	464	742

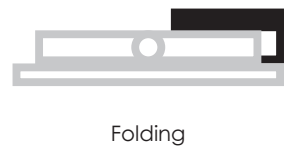

* \$200 NET surcharge per order for oversized pallet

Top Size	Base	Model Number	Hardware		Price	Frosted Acrylic Modesty Panels
10 x 36	Static or Nesting	MAP1036	-BL	-SV	\$ 400	
10 x 48	Static or Nesting	MAP1048	-BL	-SV	445	
10 x 60	Static or Nesting	MAP1060	-BL	-SV	490	
10 x 66	Static or Nesting	MAP1066	-BL	-SV	513	
10 x 72	Static or Nesting	MAP1072	-BL	-SV	535	
10 x 84	Static or Nesting	MAP1084	-BL	-SV	687	
10 x 90	Static or Nesting	MAP1090	-BL	-SV	733	
10 x 96 *	Static or Nesting	MAP1096	-BL	-SV	733	

Top Size	Basez	Model Number	Finish	Price	Perforated Metal Modesty Panels
9 x 48	Static or Nesting	MMP948	Powdercoated	\$ 547	
9 x 60	Static or Nesting	MMP960	Powdercoated	579	
9 x 72	Static or Nesting	MMP972	Powdercoated	611	

Top Size	Base	Model Number	Color	Price	Mesh Modesty Panels
10 x 36	Static or Nesting	MSP1036	Black mesh	\$ 286	
10 x 48	Static or Nesting	MSP1048	Black mesh	298	
10 x 60	Static or Nesting	MSP1060	Black mesh	313	
10 x 72	Static or Nesting	MSP1072	Black mesh	327	
10 x 84	Static or Nesting	MSP1084	Black mesh	342	
10 x 90	Static or Nesting	MSP1090	Black mesh	347	
10 x 96 *	Static or Nesting	MSP1096	Black mesh	354	

* \$200 NET surcharge per order for oversized pallet

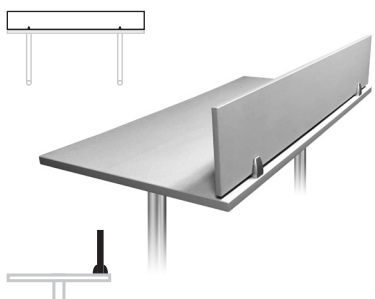
Laminate Privacy Panels	Top Size	Base	Model Number	Hardware	3P	3W
	10 x 36	Static	PP1036	Silver	\$ 291	\$ 410
	10 x 48	Static	PP1048	Silver	317	469
	10 x 60	Static	PP1060	Silver	346	529
	10 x 72	Static	PP1072	Silver	375	589
	10 x 84	Static	PP1084	Silver	481	727
	10 x 90	Static	PP1090	Silver	509	773
	10 x 96 *	Static	PP1096	Silver	509	787

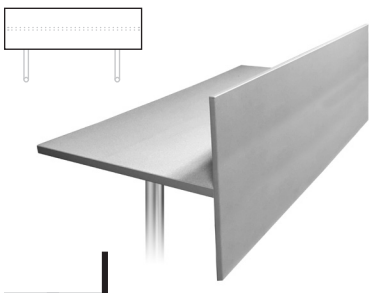
Extended Laminate Privacy Panels	Top Size	Base	Model Number	Hardware	3P	3W
	22 x 36	Static	EPP2236	02 Black	\$ 421	\$ 579
	22 x 48	Static	EPP2248	02 Black	476	668
	22 x 60	Static	EPP2260	02 Black	531	757
	22 x 72	Static	EPP2272	02 Black	658	925
	22 x 84	Static	EPP2284	02 Black	863	1,170
	22 x 90	Static	EPP2290	02 Black	876	1,199
	22 x 96 *	Static	EPP2296	02 Black	889	1,227

* \$200 NET surcharge per order for oversized pallet

Top Size	Base	Model Number	Hardware	Price	Frosted Acrylic Privacy Panels
10 x 36	Static	PAP1036	Silver	\$ 327	
10 x 48	Static	PAP1048	Silver	368	
10 x 60	Static	PAP1060	Silver	409	
10 x 72	Static	PAP1072	Silver	450	
10 x 84	Static	PAP1084	Silver	569	
10 x 90	Static	PAP1090	Silver	610	
10 x 96 *	Static	PAP1096	Silver	610	

Top Size	Base	Model Number	Hardware	Price	Extended Acrylic Privacy Panels
22 x 36	Static	EPAP2236	Chrome	\$ 486	
22 x 48	Static	EPAP2248	Chrome	563	
22 x 60	Static	EPAP2260	Chrome	640	
22 x 72	Static	EPAP2272	Chrome	717	
22 x 84	Static	EPAP2284	Chrome	892	
22 x 90	Static	EPAP2290	Chrome	930	
22 x 96 *	Static	EPAP2296	Chrome	969	

* \$200 NET surcharge per order for oversized pallet

Metal Pop-up Units

Each of our metal pop-up units feature a single touch door opening which closes when not in use. These units are available in a multitude of configurations balancing your need for conventional (15 amp/125 volt) power with USB power and data jacks. **When ordering electrical components on pages 218-225, it is the responsibility of the customer to ensure the components selected meet local electrical codes.**

Finishes: Choose between Black and Anodized Aluminum.

Cord: Choose between 72" and 120" length. All feature 15 amp/125 volt. Some units require two cords.

Cutout: You do not need to specify a grommet or add any upcharge to your table price. The cost of the cutout is included in the price of the unit.

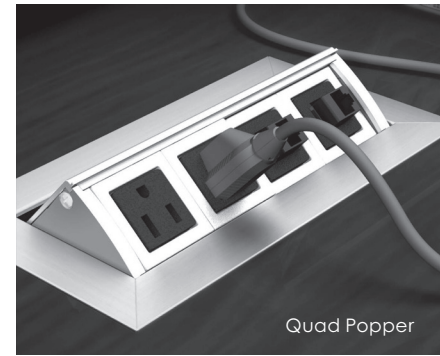

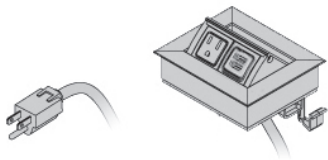
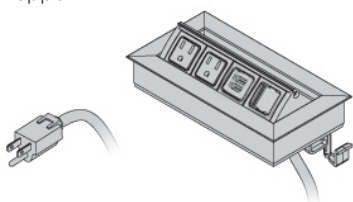
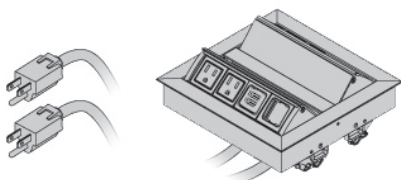
Product	Approx. Size	Configuration	Cord	Model Number	BL	AA
Twin Popper 	4 x 5"	2 Power	72"	PD04-2P-72	318	N/A
			120"	PD04-2P-120	345	N/A
		1 Power + 1 KO	72"	PD04-1P-1D-72	321	N/A
			120"	PD04-1P-1D-120	333	N/A
		1 Power + 2 USB	72"	PD04-1P-2U-72	434	N/A
			120"	PD04-1P-2U-120	461	N/A
Quad Popper 	4 x 8"	3 Power + 1 KO	72"	PD06-3P-1D-72	664	499
			120"	PD06-3P-1D-120	676	512
		2 Power + 2 KO	72"	PD06-2P-2D-72	655	492
			120"	PD06-2P-2D-120	667	505
		2 Power + 2 USB + 1 KO	72"	PD06-2P-2U-72	783	620
			120"	PD06-2P-2U-120	803	633
Butterfly Popper 	8 x 8"	6 Power + 2 KO	72"	PD08-6P-2D-72	1,339	998
			120"	PD08-6P-2D-120	1,365	1,024
		4 Power + 4 KO	72"	PD08-4P-4D-72	1,315	980
			120"	PD08-4P-4D-120	1,341	1,005
		4 Power + 4 USB + 2 KO	72"	PD08-4P-4U-72	1,571	1,236
			120"	PD08-4P-4U-120	1,597	1,261

Where would you like your power units?

For custom locations, please provide a drawing with your order.

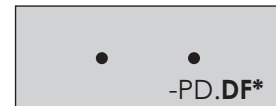

***NOTE:** Locations -PD.F & -PD.DF are NOT available on hand crank or nesting tables.

Plastic Units

These units are designed with an eye on the fixed budget. They are available in a multitude of configurations balancing your need for conventional (15 amp/125 volt) power with USB power and data jacks.

Finishes: Choose between Black and White. Other finishes are available for those units marked with "#". Contact TableX customer service for options and pricing.

Cord: Choose between 72" and 120" length. All feature 15 amp/125 volt.

Cutout: You do not need to specify a grommet or add any upcharge to your table price. The cost of the cutout is included in the price of the unit.



Product	Approx. Size	Configuration	Cord	Model Number	Color	List
	3.75" round	3 Power	72"	PD17-3P-72	-BL -WH -#	213
			120"	PD17-3P-120	-BL -WH -#	226
		2 Power + 1 USB	72"	PD17-2P-1U-72	-BL -WH -#	328
			120"	PD17-2P-1U-120	-BL -WH -#	341
	5" round	3 Power	72"	PD16-3P-72	-BL -WH	293
			120"	PD16-3P-120	-BL -WH	306
		2 Power + 1 USB	72"	PD16-2P-1U-72	-BL -WH	411
			120"	PD16-2P-1U-120	-BL -WH	423
	2.75 x 7.313 x 2.063"	2 Power + 2 USB	72"	PD18-CO-2P-2U-72	-BL -WH	478
		+ 1 KO	120"	PD18-CO-2P-2U-120	-BL -WH	490
	3.75 x 7.625 x 1.75"	2 Power + 1 Dual USB-A+C Port + Qi Wireless Charger	108"	PD19-108	-BL -WH	361

Additional Outlet Options	Description	Model Number	List
HDMI	- Fits into blank data knockouts with 18" cord	B-HDMI	127
RJ45/Cat 6	- Fits into blank data knockouts with 120" cord	B-RJ45	135

p 224-225: Unless specified on order, all USB configurations will be an A+C USB Dual Port.

Villa™ Daisylink™ System

The Villa Daisylink system is a 4 wire, 2 circuit hardwire system which allows for non-sequential plug and play use. Link up to 20 single kits or 10 double kits in a row using one of three power infeed options.

Grommet holes are pre-routed in the top, and each unit comes with a flush grommet cover.

3 finishes available:

- BL: Black grommet, black body
- SV: Silver grommet, silver body
- WH: White grommet, black body

Infeeds: You must specify a power infeed unit for each row or grouping of tables. The number of kits that can be supported per row varies depending on the infeed specified.



- Single Kit includes:**
- 1 Villa power base
 - 1 FM cable
 - 1 FF cable
 - 4 cable clamps
 - 1 grommet (on -L / -F models)



- Double Kit includes:**
- 2 Villa power bases
 - 1 FM cable
 - 2 FF cable
 - 6 cable clamps
 - 2 grommets (on -L / -F models)

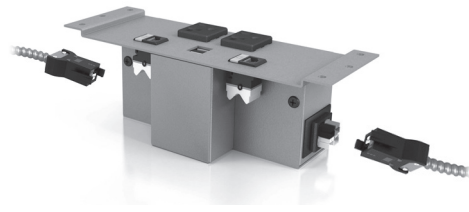

How Does the Villa Daisylink System Work?

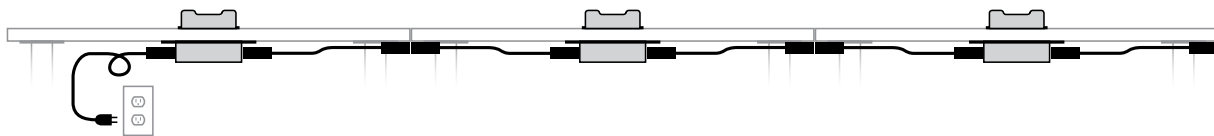



Daisylink Accessories	Description	Visual	Cord	Model Number	Price
<p>20/15 AMP Plug Infeed</p>	- 20 AMP outlet with standard 15 AMP adapter can be plugged into any standard wall outlet. - Feeds up to 10 units. - 20 total receptacles		72	VAP-72	\$231
<p>Hardwire Infeed</p>	- 2 circuit system hardwired into wall and plugs into first table in the row. - Feeds up to 20 units.		72	VHW-72	184
<p>Quick Disconnect Kit</p>	- Hardwired wall unit paired with an FF jumper unit which plugs into first table in the row. - Feeds up to 20 units.		72	VQD-72	307
<p>FM Jumper Unit</p>	- Great for linking tables around a corner, face to face, bypassing a non-powered table, or two tables that are not in perfect alignment.		12 24 36 48 60 72	VFM-12 VFM-24 VFM-36 VFM-48 VFM-60 VFM-72	100 118 136 155 172 191
<p>Splitter</p>	- Splits power to feed tables running in different directions			VT-MFM	159

accessories

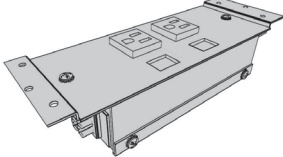
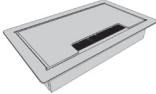
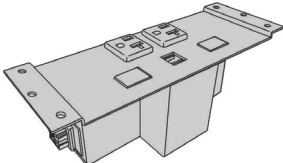
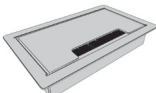
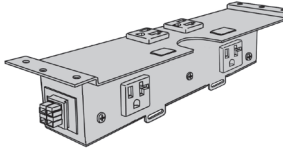
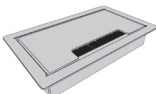
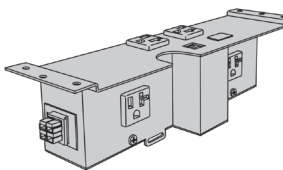
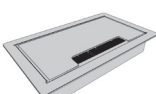
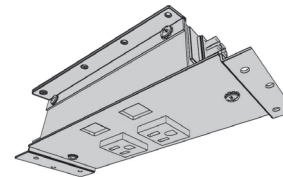
Single Villa Kits	Double Villa Kits
-------------------	-------------------

Villa Daisylink Kits	Grommet Cover	Table Size	Model No.	List	Model No.	List
2 Power + 2 KO 	3.25 x 5.5" Flush 	36"	V36SP-2P	466	N/A	N/A
		48"	V48SP-2P	466	N/A	N/A
		60"	V60SP-2P	466	V60DP-2P	850
		72"	V72SP-2P	466	V72DP-2P	850
		84"	V84SP-2P	N/A	V84DP-2P	850
		90"	V90SP-2P	N/A	V90DP-2P	N/A
		96"	V96SP-2P	N/A	V96DP-2P	850
2 Power + 1 USB + 2 KO 	3.25 x 5.5" Flush 	36"	V36SP-2P-1U	617	N/A	N/A
		48"	V48SP-2P-1U	617	N/A	N/A
		60"	V60SP-2P-1U	617	V60DP-2P-1U	1,153
		72"	V72SP-2P-1U	617	V72DP-2P-1U	1,153
		84"	V84SP-2P-1U	N/A	V84DP-2P-1U	1,153
		90"	V90SP-2P-1U	N/A	V90DP-2P-1U	N/A
		96"	V96SP-2P-1U	N/A	V96DP-2P-1U	1,153
2 Power + 2 Convenience + 2 KO 	3.25 x 5.5" Flush 	36"	V36SP-2P-2C	541	N/A	N/A
		48"	V48SP-2P-2C	541	N/A	N/A
		60"	V60SP-2P-2C	541	V60DP-2P-2C	903
		72"	V72SP-2P-2C	541	V72DP-2P-2C	903
		84"	V84SP-2P-2C	N/A	V84DP-2P-2C	903
		90"	V90SP-2P-2C	N/A	V90DP-2P-2C	N/A
		96"	V96SP-2P-2C	N/A	V96DP-2P-2C	903
2 Power + 2 USB + 2 Convenience + 1 KO 	3.25 x 5.5" Flush 	36"	V36SP-2P-1U-2C	692	N/A	N/A
		48"	V48SP-2P-1U-2C	692	N/A	N/A
		60"	V60SP-2P-1U-2C	692	V60DP-2P-1U-2C	1,206
		72"	V72SP-2P-1U-2C	692	V72DP-2P-1U-2C	1,206
		84"	V84SP-2P-1U-2C	N/A	V84DP-2P-1U-2C	1,206
		90"	V90SP-2P-1U-2C	N/A	V90DP-2P-1U-2C	N/A
		96"	V96SP-2P-1U-2C	N/A	V96DP-2P-1U-2C	1,206
2 Convenience Underbar + 2 KO 	None	36"	V36SP-2C	525	N/A	N/A
		48"	V48SP-2C	525	N/A	N/A
		60"	V60SP-2C	525	V60DP-2C	697
		72"	V72SP-2C	525	V72DP-2C	697
		84"	V84SP-2C	525	V84DP-2C	697
		90"	V90SP-2C	N/A	V90DP-2C	N/A
		96"	V96SP-2C	525	V96DP-2C	697

Villa Accessories	Description	Model Number	List
Villa RJ45 Data Keystone 	- Fits into blank data knockouts	V-RJ45	72
Villa HDMI Keystone 	- Fits into blank data knockouts	V-HDMI	76
Villa USB-C Keystone 	- Fits into blank data knockouts (Keystone only)	V-USB-C	46
	- Keystone with 3ft C-C Cable	V-USB-C-CORD	105

"Villa" and "Daisylink" are trademarks of Dekko.

Cove™ Daisylink™ System

The Cove Daisylink system is a 4 wire, 2 circuit hardwire system which allows for non-sequential plug and play use. Link up to 20 single kits or 10 double kits in a row using one of three power infeed options.

Grommet holes are pre-routed in the top. All outlets and body of unit is black.

3 face plate finishes available:

- BL: Black
- SV: Silver
- WH: White

Infeeds: You must specify a power infeed unit for each row or grouping of tables. The number of kits that can be supported per row varies depending on the infeed specified.



Single Kit includes:

- 1 Cove power base
- 1 FM cable
- 1 FF cable
- 4 cable clamps
- 1 grommet (on -L / -F models)



Double Kit includes:

- 2 Cove power bases
- 1 FM cable
- 2 FF cable
- 6 cable clamps
- 2 grommets (on -L / -F models)

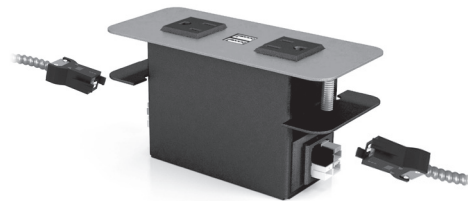



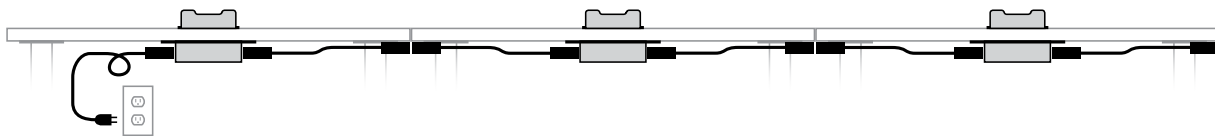





How Does the Cove Daisylink System Work?

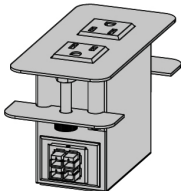

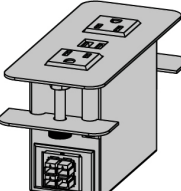
Daisylink Accessories	Description	Visual	Cord	Model Number	Price
20/15 AMP Plug Infeed 	- 20 AMP outlet with standard 15 AMP adapter can be plugged into any standard wall outlet. - Feeds up to 10 units.		72	VAP-72	\$231
Hardwire Infeed 	- 2 circuit system hardwired into wall and plugs into first table in the row. - Feeds up to 20 units.		72	VHW-72	184
Quick Disconnect Kit 	- Hardwired wall unit paired with an FF jumper unit which plugs into first table in the row. - Feeds up to 20 units.		72	VQD-72	307
FM Jumper Unit 	- Great for linking tables around a corner, face to face, bypassing a non-powered table, or two tables that are not in perfect alignment.		12 24 36 48 60 72	VFM-12 VFM-24 VFM-36 VFM-48 VFM-60 VFM-72	100 118 136 155 172 191
Splitter 	- Splits power to feed tables running in different directions			VT-MFM	159

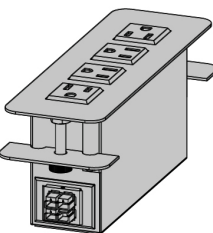
accessories

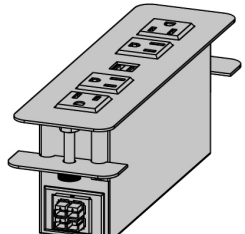
Single Cove Kits	Double Cove Kits
------------------	------------------

Cove Daisylink Kits	Face Plate	Table Size	Model No.	List	Model No.	List
2 Power 	2.5 x 5" 	36"	C36SP-2P	507	N/A	N/A
		48"	C48SP-2P	507	N/A	N/A
		60"	C60SP-2P	507	C60DP-2P	888
		72"	C72SP-2P	507	C72DP-2P	888
		84"	C84SP-2P	N/A	C84DP-2P	888
		96"	C96SP-2P	N/A	C96DP-2P	888
2 Power + 2 USB 	2.5 x 5.75" 	36"	C36SP-2P-2U	659	N/A	N/A
		48"	C48SP-2P-2U	659	N/A	N/A
		60"	C60SP-2P-2U	659	C60DP-2P-2U	1,186
		72"	C72SP-2P-2U	659	C72DP-2P-2U	1,186
		84"	C84SP-2P-2U	N/A	C84DP-2P-2U	1,186
		96"	C96SP-2P-2U	N/A	C96DP-2P-2U	1,186
4 Power 	2.5 x 7.75" 	36"	C36SP-4P	731	N/A	N/A
		48"	C48SP-4P	731	N/A	N/A
		60"	C60SP-4P	731	C60DP-4P	1,334
		72"	C72SP-4P	731	C72DP-4P	1,334
		84"	C84SP-4P	N/A	C84DP-4P	1,334
		96"	C96SP-4P	N/A	C96DP-4P	1,334
4 Power + 2 USB 	2.5 x 8.75" 	36"	C36SP-4P-2U	882	N/A	N/A
		48"	C48SP-4P-2U	882	N/A	N/A
		60"	C60SP-4P-2U	882	C60DP-4P-2U	1,633
		72"	C72SP-4P-2U	882	C72DP-4P-2U	1,633
		84"	C84SP-4P-2U	N/A	C84DP-4P-2U	1,633
		96"	C96SP-4P-2U	N/A	C96DP-4P-2U	1,633

"Cove" & "Daisylink" are trademarks of Dekko.

Villa™ Corded System

This system is built with easy plug-and-play capabilities and reconfiguration in mind. Each table can be plugged into the wall separately or can be piggy-backed off of the next table. (Max of 6 units in any run.)

- 3 finishes available:**
- BL: Black grommet, black body
 - SV: Silver grommet, silver body
 - WH: White grommet, black body

Grommet holes are pre-routed in the top, and each unit comes with a flush grommet cover.

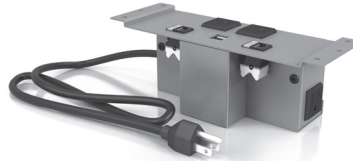

How Does the Villa Corded System Work?

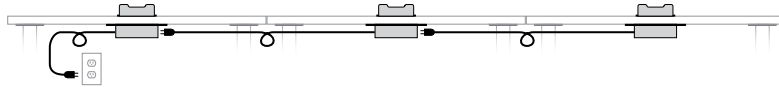

Villa Corded Units	Grommet Cover	Model Number	Cord	Color	List
2 Power + 1 Convenience + 2 KO 	3.25 x 5.5" Flush 	VC-2P-1C-_-_-	-36 -72 -108	-BL -SV	\$ 338
2 Power + 2 USB + 1 Convenience + 2 KO 	3.25 x 5.5" Flush 	VC-2P-2U-1C-_-_-	-36 -72 -108	-BL -SV	\$ 490
2 Power + 3 Convenience + 2 KO 	3.25 x 5.5" Flush 	VC-2P-3C-_-_-	-36 -72 -108	-BL -SV	\$ 392
2 Power + 2 USB + 3 Convenience + 1 KO 	3.25 x 5.5" Flush 	VC-2P-2U-3C-_-_-	-36 -72 -108	-BL -SV	\$ 536
3 Convenience Undermount 	None	VC-3C-_-_-	-36 -72 -108	-BL -SV	\$ 242

Villa Accessories	Description	Model Number	List
Villa RJ45 Data Keystone 	- Fits into blank data knockouts	V-RJ45	72
Villa HDMI Keystone 	- Fits into blank data knockouts	V-HDMI	76
Villa USB-C Keystone 	- Fits into blank data knockouts (Keystone only) - Keystone with 3ft C-C Cable	V-USB-C V-USB-C-CORD	46 105

accessories

"Villa" is a trademark of Dekko.

Cove™ Corded System

Smooth access to power and USB power that runs flush to the table top.





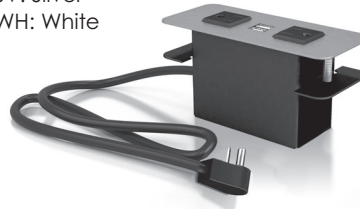

Some models are available with convenience outlets to allow table to be piggy-backed off of the next table. (Max of 6 units in any run.)

Grommet holes are pre-routed in the top. All outlets and body of unit is black.

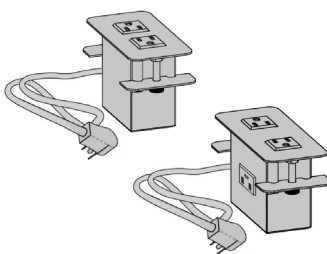

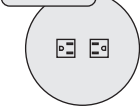
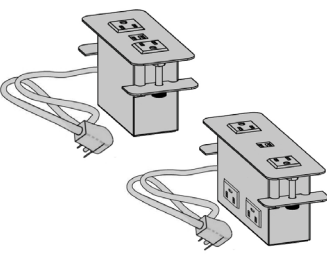
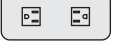

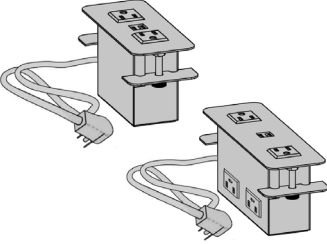
3 face plate finishes available:

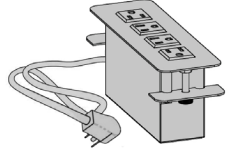
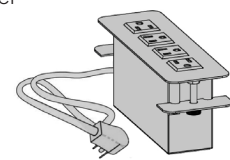
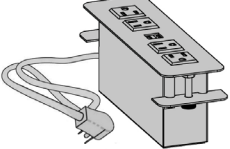
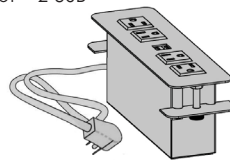
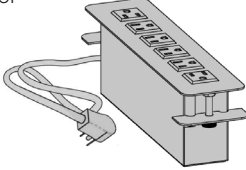
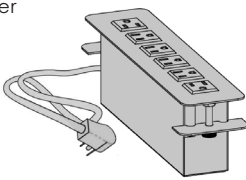
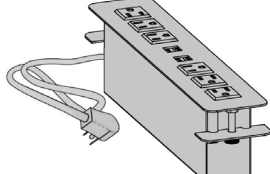
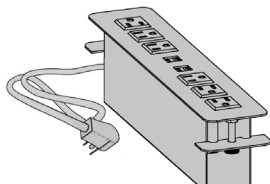

- BL: Black
- SV: Silver
- WH: White







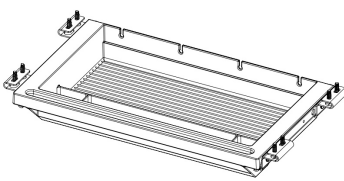

Cove Corded Units	Face Plate	Specs	Model Number	Color	List
	 2.5 x 5"	Rectangle	CC108-2P	-BL -SV	\$ 339
	 6"	Round	CC108-2P-RD	-BL -SV	\$ 339
	 2.5 x 5.75"	Rectangle +1 Convenience	CC108-2P-1C	-BL -SV	\$ 362
	 6"	Round	CC108-2P-2U-RD	-BL -SV	\$ 485
	 2.5 x 7.75"	Rectangle +2 Convenience	CC108-2P-2U-2C	-BL -SV	\$ 638
		 2.5 x 7.75"	Rectangle	CC108-4P	-BL -SV
	 2.5 x 8.75"	Rectangle	CC108-4P-2U	-BL -SV	\$ 608
		 2.5 x 10.75"	Rectangle	CC108-6P	-BL -SV
	 2.5 x 13.25"	Rectangle	CC108-6P-4U	-BL -SV	\$ 808

"Cove" is a trademark of Dekko.

Product	Description	Length	Model Number	Color	Price
Built-in Wire Management Leg 	1 x 19" steel hinged access door built into one base. Door runs within 2.5" of top plate and bottom of base. Door height varies depending on series and options. Not available on all series. Check series intro for compatibility.	N/A	-WM	matches base color	+ \$139 - - -
Snap-on Wire Management Leg Cover 	Snaps on to round columns and offers coverage of wires down the leg. Check series intro for compatibility. Powdercoated steel to match base color (not available in chrome). Available for 2" and 3" columns.	N/A	-WMLC.2 -WMLC.3	matches base color	50 79 - -
Magnetic Wire Management Leg Cover 	Magnetically attaches to rectangular and square bases, offering coverage of wires down the leg. Check series intro for compatibility. Powdercoated steel to match base color.	N/A	-MMLC	matches base color	71 - - -
Vertical Spine Management 3 x 1.5 	Oval spine conceals and carries wires from under desk to floor. Single channel on each side to keep cords separate where code requires. Screws to under side of worksurface with weighted base. Available in Silver Metallic.	30" 42"	WMH WMH-SH	Silver Silver	174 241 - -
J-Channel Management 3.25 x 1" 	Ideal when cords need to be moved often. Can be attached to underside of the table or to a modesty panel. Self adhesive tape applied for easy installation. Black plastic.	12" 36" 60" 72"	WMA1 WMA3 WMA5 WMA6	Black Black Black Black	108 139 191 205 -
Wave Cable Gripper 5.75" x 1.75" 	This cable manager features an intelligent design that allows wires to slip into the unit. Place these grips anywhere you need to get wires under control. Simple to install with only two screws, users can easily move to different positions as their work environment changes.	N/A	CG4	Black	18

Product	Description	Length	Model Number	Color	Price
Vertebrae Management 3.125 x 1" 	Contains four separate channels. Two main channels and two smaller which allow wires to sit in a .5" trough. Black plastic.	36"	WMD3	Black	\$ 114
Grommet 2.75 x 2.75" 	Add grommets to any table top for \$45 each. Use chart below to select grommet location. For example, add "-GR.D" at the end of the model number for a table needing two grommets in location D and add \$89 to the list price. Black plastic.	N/A	-GR.---	Black	45 ea.
MINI Drawer 13.6"w x 8"d x 2"h 	A thin-profile, non-locking drawer with ball bearing slides designed to fit underneath work surfaces, especially height-adjustable tables. The MINI drawer is only 8" in depth and features a tray that can slide across the drawer and can also be removed and placed on the work surface to hold accessories or personal items. The tray also allows for easy-access storage inside the drawer. Wire management slots on the backside of the MINI allow the user to place items such as their mobile phone inside and then draw the charging cord out the back.	N/A	-MD	Black	104

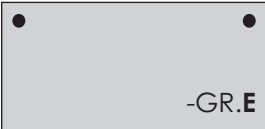
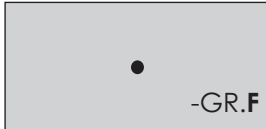
Where would you like your grommets? For custom locations, please provide a drawing with your order.

 -GR.A	 -GR.B	 -GR.C	 -GR.D
 -GR.E	 -GR.F	 -GR.G	 -GR.DF

Note: GR.F and GR.DF are NOT available on nesting tables.

Folding Table Carts

Table Shape	Max Table	Capacity	Model #	Finish	Price	Mobile Carts
Round	60"	Four short-fold tables	STC-RD60	01 Structured Black	\$ 1,828	
Rectangle	30 x 60"	Six folding tables	STC-TC60	01 Structured Black	1,821	
	30 x 72"	Six folding tables	STC-TC72	01 Structured Black	2,012	
	30 x 84"	Six folding tables	STC-TC84	01 Structured Black	2,042	
	30 x 96 **	Six folding tables	STC-TC96	01 Structured Black	2,186	