

table

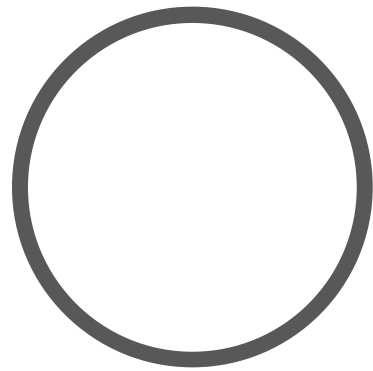

**03 trig**  
price list

Effective January 1, 2025

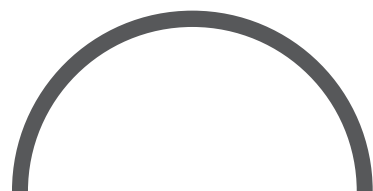
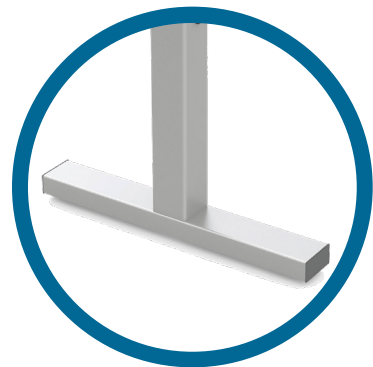



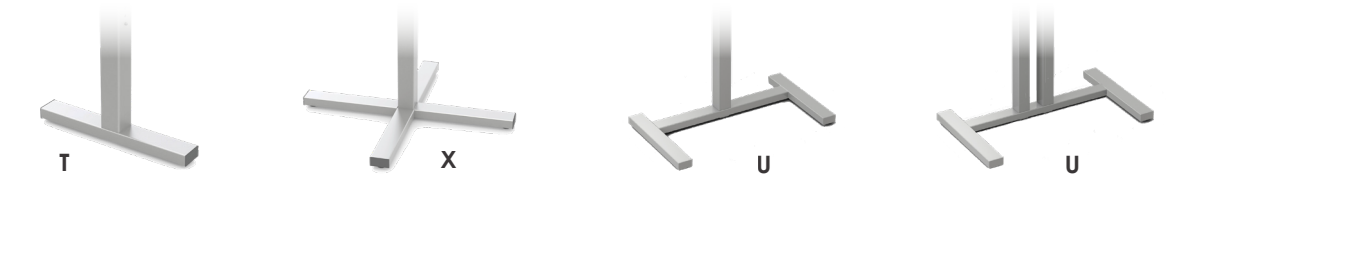

Our Trig series was created from a consistent need for flexibility within a workspace. Whether it's a private office, training area, classroom or multi-purpose space, Trig will satisfy your height adjustability, flip-top nesting and mobility requirements. Trig even offers a rechargeable battery-height nesting table with a 15° tilt-lock 'drafting' angle setting.

### Trig Base Styles



### Trig Options

<p>Standard Glides</p> 	<p><b>SLC.3</b> <b>3" Soft Locking Casters</b> can be added to any table for \$147 per set of four.</p>	<p><b>FT</b> <b>Flip Tops</b> are not available on Trig tables.</p>	<p><b>SH</b> <b>Special Height</b> can be added to any table:                  + \$72 per column for heights &gt; 29"                  + \$39 per column for heights &lt; 29"                  Special height tables with tops larger than 36x72" must be custom quoted.</p>
<p>3" Soft Locking Casters</p> 	<p><b>FD</b> <b>Folding Bases</b> are not available on Trig tables.</p>	<p><b>WM</b> <b>Wire Management</b> (built-in) is not available on Trig tables.</p>	<p><b>FR</b> <b>Footring</b> is not available on Trig tables.</p>
	<p><b>GF</b> <b>G-Flip Nesting Tables</b> are priced accordingly with 3" locking casters.</p>	<p><b>MMLC</b> <b>Magnetic Wire Management Leg Covers</b> Magnetically attaches onto any square leg and are \$71 each.</p>	<p><b>CH</b> <b>Chrome Finish</b> is not available on Trig tables.</p>
	<p><b>GT</b> <b>G-Flip 15° Tilt Lock</b> "drafting angle" option available on G-Flip tables (no upcharge).</p>	<p><b>OS</b> <b>Offset T-bases</b> are not available on Trig tables.</p>	

## Trig Height Adjustable Options

**BL Pneumatic** is available on X-bases. Available height adjustable finishes can be found on page 9.

Two-leg pneumatic units are only available in three finishes:

- 30 Pearl
- 37 Satin Silver
- 57 Jet

**BEH Battery Electric Height** is available on T-bases and are available in two finishes:

- 37 Satin Silver
- 57 Jet

## Trig Top Shapes

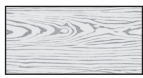

Rectangle  
p. 73-75



Square  
p.75



Round  
p.75

## Trig Top Options

**QG Quick-Connect Ganging Brackets** can be added to any table for \$45 (includes 4 connectors per table).

**RC 3" Radius Corners** can be added to any table for \$61.

**GR Grommets** can be added to any table for \$45 each. To see specific locations, see page 233.

**PS Acrylic Pencil Stop** can be added to any GT "tilt lock" Trig table for \$75 each.

## Trig Edge Options

(corresponds with 3 columns of pricing)

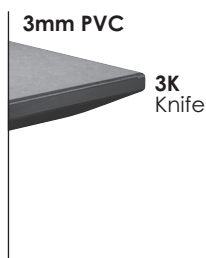
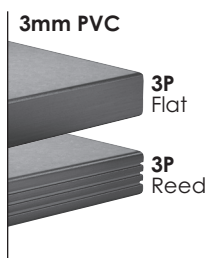

## Battery Electric Height Adjustability

Battery electric height adjustability gives you the ability to adjust tables via Bluetooth™ or memory touchpad. The standard memory keypad will remember your four favorite heights. Available on Trig T-bases, this option works great in private offices or even in conference rooms.

**To specify:**

All available battery models are priced in the following pages. They are denoted by the "BEH" at the end of the model number.

**Example:**

03TC2060T18BEH-3P  
20x60" **battery electric height** table  
**\$3,073** List Price

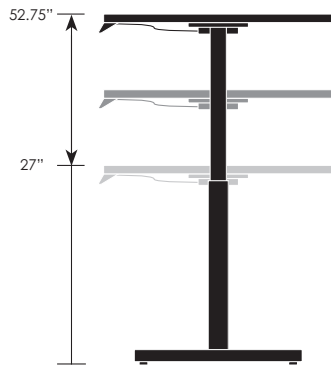

**BEH** Battery Electric T-bases

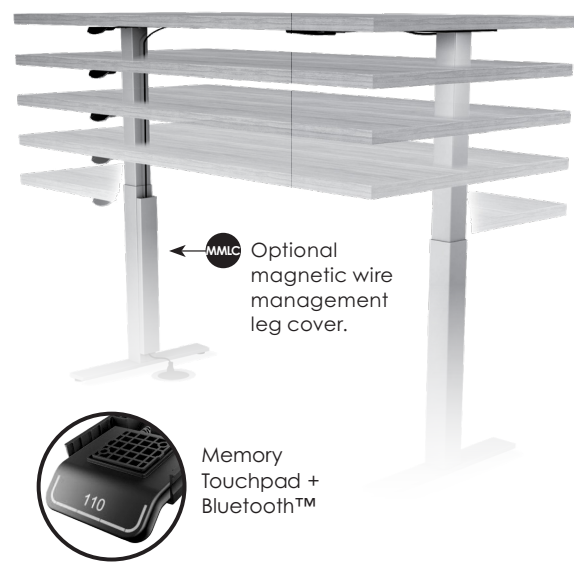

## Pneumatic Height Adjustability

Pneumatic tables go from seated-to-standing height. Available on tables using single X-bases, these tables are easy to adjust. Simply squeeze the small handle underneath and gently move the top to your desired height. It's that easy.

**Example:**

03RD3636X32BL-3P  
36" round **pneumatic** table  
**\$1,469** List Price

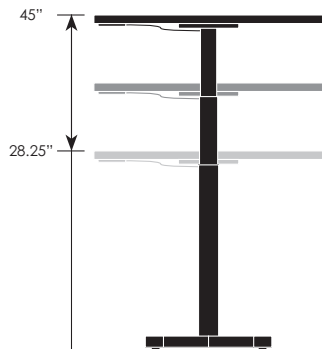

**BL** Pneumatic X-bases



Want to use Trig on the go? Just add 3" to each vertical measurement to account for the added height of locking casters.

**To specify:**

All available pneumatic models are priced in the following pages. They are denoted by the "BL" at the end of the model number.

## G-Flip Nesting

G-Flip tables allow for compact nesting and minimizes storage space to only 4 3/4" per table. Latch can be accessed from either end of the top for a quick flip-and-roll. Its design allows plenty of room for electrical components.

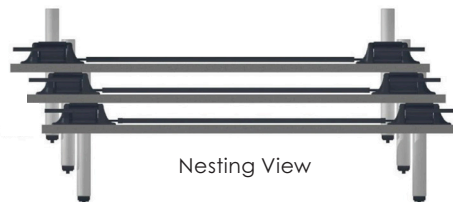

**To specify:**







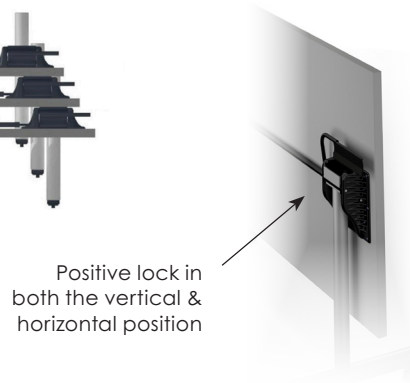















All available G-Flip models are priced in the following pages. They are denoted by the "GF" at the end of the model number.

**Example:**





03TC3072T26GF-3P  
36" round **G-Flip nesting** table  
**\$1,675** List Price





For Trig series table options, please reference pages 70-71.



Top Size	Base	Model Number	3P	3K	3W	Rectangular with T-bases
20 x 48	Static	03TC2048T18	\$ 858	\$ 957	\$ 1,046	 
	G-Flip Nesting	03TC2048T18GF	1,435	1,533	1,622	
	Pneumatic height	03TC2048T18BL	2,037	2,136	2,225	
	Pneumatic + GF Nesting	03TC2048T18BLGF	2,614	2,712	2,801	
	Battery electric height	03TC2048T18BEH	3,045	3,143	3,232	
	Battery + GF Nesting	03TC2048T18BEHGF	3,709	3,808	3,897	
20 x 60	Static	03TC2060T18	886	996	1,105	   
	G-Flip Nesting	03TC2060T18GF	1,463	1,573	1,682	
	Pneumatic height	03TC2060T18BL	2,073	2,183	2,292	
	Pneumatic + GF Nesting	03TC2060T18BLGF	2,650	2,759	2,869	
	Battery electric height	03TC2060T18BEH	3,073	3,182	3,292	
	Battery + GF Nesting	03TC2060T18BEHGF	3,737	3,847	3,956	
20 x 72	Static	03TC2072T18	938	1,069	1,191	   
	G-Flip Nesting	03TC2072T18GF	1,584	1,714	1,837	
	Pneumatic height	03TC2072T18BL	2,202	2,332	2,455	
	Pneumatic + GF Nesting	03TC2072T18BLGF	2,778	2,909	3,031	
	Battery electric height	03TC2072T18BEH	3,194	3,324	3,447	
	Battery + GF Nesting	03TC2072T18BEHGF	3,858	3,989	4,111	
24 x 48	Static	03TC2448T22	874	972	1,071	   
	G-Flip Nesting	03TC2448T22GF	1,450	1,549	1,647	
	Pneumatic height	03TC2448T22BL	2,051	2,149	2,248	
	Pneumatic + GF Nesting	03TC2448T22BLGF	2,627	2,726	2,825	
	Battery electric height	03TC2448T22BEH	3,060	3,159	3,257	
	Battery + GF Nesting	03TC2448T22BEHGF	3,599	3,698	3,796	
24 x 60	Static	03TC2460T22	901	1,011	1,130	   
	G-Flip Nesting	03TC2460T22GF	1,478	1,588	1,707	
	Pneumatic height	03TC2460T22BL	2,085	2,195	2,314	
	Pneumatic + GF Nesting	03TC2460T22BLGF	2,662	2,772	2,890	
	Battery electric height	03TC2460T22BEH	3,088	3,198	3,317	
	Battery + GF Nesting	03TC2460T22BEHGF	3,627	3,737	3,856	
24 x 72	Static	03TC2472T22	953	1,084	1,216	   
	G-Flip Nesting	03TC2472T22GF	1,599	1,730	1,862	
	Pneumatic height	03TC2472T22BL	2,229	2,360	2,492	
	Pneumatic + GF Nesting	03TC2472T22BLGF	2,806	2,937	3,069	
	Battery electric height	03TC2472T22BEH	3,209	3,340	3,472	
	Battery + GF Nesting	03TC2472T22BEHGF	3,748	3,879	4,011	



For Trig series table options, please reference pages 70-71.



Rectangular with T-bases	Top Size	Base	Model Number	3P	3K	3W
 <div style="display: flex; justify-content: space-around; margin-top: 10px;"> <div style="text-align: center;">                       G-Flip Nesting                 </div> <div style="text-align: center;">                       Pneumatic Height Adjustable                 </div> <div style="text-align: center;">                       Battery Height Adjustable                 </div> </div>	30 x 48	Static	03TC3048T26	\$ 948	\$ 1,070	\$ 1,165
		G-Flip Nesting	03TC3048T26GF	1,525	1,647	1,742
		Pneumatic height	03TC3048T26BL	2,110	2,232	2,327
		Pneumatic + GF Nesting	03TC3048T26BLGF	2,686	2,809	2,904
		Battery electric height	03TC3048T26BEH	3,136	3,258	3,354
		Battery + GF Nesting	03TC3048T26BEHGF	3,675	3,797	3,893
	30 x 60	Static	03TC3060T26	971	1,103	1,220
		G-Flip Nesting	03TC3060T26GF	1,588	1,719	1,836
		Pneumatic height	03TC3060T26BL	2,162	2,294	2,411
		Pneumatic + GF Nesting	03TC3060T26BLGF	2,739	2,871	2,988
		Battery electric height	03TC3060T26BEH	3,159	3,291	3,408
		Battery + GF Nesting	03TC3060T26BEHGF	3,698	3,830	3,947
	30 x 72	Static	03TC3072T26	1,029	1,184	1,312
		G-Flip Nesting	03TC3072T26GF	1,675	1,830	1,958
		Pneumatic height	03TC3072T26BL	2,290	2,445	2,573
		Pneumatic + GF Nesting	03TC3072T26BLGF	2,867	3,021	3,150
		Battery electric height	03TC3072T26BEH	3,287	3,442	3,570
		Battery + GF Nesting	03TC3072T26BEHGF	3,826	3,981	4,109
36 x 48	Static	03TC3648T26	1,007	1,152	1,244	
	G-Flip Nesting	03TC3648T26GF	1,458	1,604	1,696	
	Battery electric height	03TC3648T26BEH	3,195	3,341	3,433	
	Battery + GF Nesting	03TC3648T26BEHGF	3,734	3,880	3,972	
36 x 60	Static	03TC3660T26	1,096	1,277	1,371	
	G-Flip Nesting	03TC3660T26GF	1,673	1,854	1,948	
	Battery electric height	03TC3660T26BEH	3,284	3,466	3,559	
	Battery + GF Nesting	03TC3660T26BEHGF	3,823	4,005	4,098	
36 x 72	Static	03TC3672T26	1,152	1,356	1,462	
	G-Flip Nesting	03TC3672T26GF	1,798	2,002	2,108	
	Battery electric height	03TC3672T26BEH	3,409	3,613	3,719	
	Battery + GF Nesting	03TC3672T26BEHGF	3,948	4,152	4,258	

Rectangular w/ Single Column U-bases	Top Size	Base	Model Number	3P	3K	3W
 <div style="margin-top: 10px;">                       Pneumatic Height Adjustable                 </div>	24 x 42	Static	03TC2442U2236	\$ 1,000	\$ 1,098	\$ 1,182
		Pneumatic height	03TC2442U2236BL	1,828	1,927	2,011
	30 x 42	Static	03TC3042U2636	1,074	1,196	1,277
		Pneumatic height	03TC3042U2636BL	1,907	2,029	2,110
	36 x 42	Static	03TC3642U2636	1,133	1,279	1,356
		Pneumatic height	03TC3642U2636BL	1,966	2,112	2,189

For Trig series table options, please reference pages 70-71.

Top Size	Base	Model Number	3P	3K	3W	Rectangular w/ Double Column U-bases
24 x 48	Static	03TC2448U2242	\$ 1,196	\$ 1,295	\$ 1,393	   <p>Pneumatic Height Adjustable</p>
	Pneumatic height	03TC2448U2242BL	2,371	2,469	2,568	
24 x 60	Static	03TC2460U2242	1,224	1,334	1,453	
	Pneumatic height	03TC2460U2242BL	2,399	2,508	2,627	
24 x 72	Static	03TC2472U2242	1,276	1,407	1,539	
	Pneumatic height	03TC2472U2242BL	2,451	2,581	2,713	
30 x 48	Static	03TC3048U2642	1,272	1,394	1,490	
	Pneumatic height	03TC3048U2642BL	2,448	2,570	2,666	
30 x 60	Static	03TC3060U2642	1,295	1,427	1,544	
	Pneumatic height	03TC3060U2642BL	2,471	2,603	2,720	
30 x 72	Static	03TC3072U2642	1,354	1,509	1,637	
	Pneumatic height	03TC3072U2642BL	2,530	2,685	2,813	
36 x 48	Static	03TC3648U2642	1,331	1,477	1,569	
	Pneumatic height	03TC3648U2642BL	2,507	2,653	2,745	
36 x 60	Static	03TC3660U2642	1,420	1,602	1,696	
	Pneumatic height	03TC3660U2642BL	2,596	2,777	2,871	
36 x 72	Static	03TC3672U2642	1,476	1,680	1,786	
	Pneumatic height	03TC3672U2642BL	2,652	2,856	2,962	

Top Size	Base	Model Number	3P	3K	3W	Square with X-bases
24 x 24	Static	03SQ2424X22	\$ 679	\$ 730	\$ 807	   <p>Pneumatic Height Adjustable</p>
30 x 30	Static	03SQ3030X26	757	835	921	
	Pneumatic height	03SQ3030X26BL	1,388	1,498	1,588	
36 x 36	Static	03SQ3636X32	856	966	1,056	
	Pneumatic height	03SQ3636X32BL	1,388	1,498	1,588	
42 x 42	Static	03SQ4242X36	952	1,101	1,191	
	Pneumatic height	03SQ4242X36BL	1,484	1,633	1,723	

Top Size	Base	Model Number	3P	3K	3W	Round with X-bases
24 x 24	Static	03RD2424X22	\$ 721	\$ 788	\$ 828	   <p>Pneumatic Height Adjustable</p>
30 x 30	Static	03RD3030X26	823	927	962	
	Pneumatic height	03RD3030X26BL	1,469	1,611	1,640	
36 x 36	Static	03RD3636X32	937	1,079	1,108	
	Pneumatic height	03RD3636X32BL	1,469	1,611	1,640	
42 x 42	Static	03RD4242X32	1,065	1,259	1,272	
	Pneumatic height	03RD4242X32BL	1,597	1,791	1,803	

For Trig series table options, please reference pages 70-71.